



# Owner's Manual

FOR THE TURBOCHEF ECO RAPID COOK OVEN





For further information, call

800.90TURBO

or

+1 214.379.6000

## Original Instructions

The information contained in this manual is important for the proper installation, use, maintenance, and repair of this oven. Follow these procedures and instructions to help ensure satisfactory baking results and years of trouble-free service.

Errors – descriptive, typographic, or pictorial – are subject to correction. Specifications are subject to change without notice.

Please carefully read this manual and retain it for future reference.

# Table of Contents

## Important Safety Instructions

General Safety Information	i
Reducing Fire Risk	ii
Grounding Instructions	ii
Power Cord Replacement or Removal	ii
Precautions to Avoid Possible Exposure to Excessive Microwave Energy	ii
RF Interference Considerations	iii
Protective Earth (Ground) Symbol	iii
Equipotential Bonding Symbol	iii

## Specifications and Installation

Theory of Operation	1
Features	1
Dimensions	1
Certifications	2
Oven Construction	2
Electrical Specifications	2
Installation	2
Unpacking Instructions	2
Installation Warnings - Read Before Lifting Oven	2
Lifting and Placing the Oven	3
Installation Near Open Heat Source	3
Oven Restraint Kit	4
ChefComm Pro®	4
Middleby Connect™	4
Date and Time Prompt	4
Registration Prompt	4
Voltage Selection	4
Ventilation	5

## Cleaning

Daily Maintenance	6-7
-------------------	-----

## Oven Controls

8

## Cooking

Menu Cook Mode	9
Manual Cook Mode	12

## Info Mode

Information Screen	13
Serial Number	13
Menu Version	13
Sage Firmware	13
Phoenix Firmware	13
Service Number	13
Measured VAC (Voltage)	13
WiFi Connectivity Status	13
Tutorials	13
Counters Screen	13
Cook Counter	13
Total Cook Time	13
Magnetron Time	13
Total Time (oven on)	13
Power Cycle Count	13
Menu Repair Counter	13
Fault log	13
Options Screen	14
Editing	14
Cook More	14
Load Menu	14
VAC	14
Demo Mode	14
Manual Cooking	14
Diagnostic Mode	14
F2 Bypass	14
Settings Screen	14
Temperature Measurement	15
Language	15
WiFi Network	15
Sound Volume	16
Date	16
Time	16
Auto On	16
Auto Off	17

Service Screen	17
Manufacturing (MFG)	17
Load Menu from USB	17
Save Menu to USB	18
Firmware Update	18
<b>Edit Mode</b>	
Edit Set Temperature	19
Access Edit Items Screen	19
Name a Group	20
Delete a Group	20
Move a Group	21
Item Editing Options	21
Edit Settings	23
Name Item	25
Change Group	26
Move Item	26
Delete Item	27
<b>Troubleshooting</b>	28
<b>North America Limited Warranty</b>	30
<b>International Limited Warranty</b>	32

This page intentionally blank.



# IMPORTANT SAFETY INSTRUCTIONS

**⚠ WARNING:** When operating this oven, strictly adhere to the following safety precautions to reduce the risk of burns, electric shock, fire, injury, damage to oven or property near oven, or possible exposure to excessive microwave energy.

## GENERAL SAFETY INFORMATION

- ✓ Read all instructions before using this appliance.
- ✓ Read and follow the specific “Precautions to Avoid Possible Exposure to Excessive Microwave Energy” found on page ii.
- ✓ This appliance must be grounded. Connect only to a properly grounded outlet. See “Grounding Instructions” on page ii.
- ✓ Install or locate this appliance only in accordance with the provided installation instructions.
- ✓ This appliance should be serviced by qualified service personnel only. Contact the nearest authorized service facility for examination, repair, or adjustment.
- ✓ Keep the cord away from heated surfaces.
- ✓ Liquids, such as water, coffee, or tea are able to be overheated beyond the boiling point without appearing to be boiling. Visible bubbling or boiling when the container is removed from the microwave oven is not always present. **THIS COULD RESULT IN VERY HOT LIQUID SUDDENLY BOILING OVER WHEN THE CONTAINER IS DISTURBED OR A UTENSIL IS INSERTED INTO THE LIQUID.**
- ✓ **WARNING:**The contents of feeding bottles and baby food jars must be stirred or shaken and the temperature checked before consumption, in order to avoid burns (IEC 60335-2-90).
- ✓ Use this appliance only for its intended uses as described in this manual.
- ✓ Only use utensils that are suitable for use in microwave ovens (IEC 60335-2-90).
- x **DO NOT** use corrosive chemicals or vapors in this appliance; it is not designed for industrial/laboratory use.
- x **WARNING:** **DO NOT** heat liquids or other foods in sealed containers (e.g., jars, whole eggs, etc.) since they are liable to explode.
- x **DO NOT** allow children to use this appliance.
- x **DO NOT** operate this appliance if it has a damaged cord or plug, is not working properly, or has been damaged or dropped. See “Power Cord Replacement or Removal” found on page ii.
- x **DO NOT** cover or block any openings on this appliance.
- x **DO NOT** store this appliance outdoors.
- x **DO NOT** use this product near water (e.g., near a kitchen sink, in a wet basement, near a swimming pool).
- x **DO NOT** immerse the cord or plug in water.
- x **DO NOT** let the cord hang over the edge of a table or counter.
- x **DO NOT** use a water jet for cleaning. See pages 6-7 in this manual for proper cleaning procedures.
- x **WARNING:** Due to the nature of the appliance, the floors around it may be slippery.
- x This appliance is not to be used by children or persons with reduced physical, sensory or mental capabilities, or lack of experience and knowledge, unless they have been given supervision or instruction.

**SAVE THESE INSTRUCTIONS**

## REDUCING FIRE RISK

- ✓ Remove wire twist-ties from paper or plastic bags used to facilitate cooking in the oven.
- ✓ If materials inside the oven ignite, keep the oven door closed, turn the oven off, and disconnect the power cord or shut off power at the fuse or circuit breaker panel.
- ✓ If smoke is observed, switch off or unplug the oven. Keep the door closed to stifle any flames.
- x DO NOT use the cook cavity for storage purposes.
- x DO NOT overcook food. Carefully attend to the oven if paper, plastic, or other combustible materials are placed inside the oven to facilitate cooking.
- x DO NOT leave paper products, cooking utensils, or food in the cavity when the oven is not in use.

## GROUNDING INSTRUCTIONS

This appliance must be grounded. In the event of an electrical short circuit, grounding reduces the risk of electric shock by providing an escape wire for the electric current. This appliance is equipped with a cord having a grounding wire with a grounding plug. The plug must be plugged into an outlet that is properly installed and grounded.

 **WARNING:** Improper use of the grounding can result in a risk of electric shock.

Consult a qualified electrician or serviceman if the grounding instructions are not completely understood, or if doubt exists as to whether the appliance is properly grounded, and either:

1. If it is necessary to use an extension cord, use only a 3-wire extension cord that has a 3-blade grounding plug, and a 3-slot receptacle that will accept the plug on the appliance. The marked rating of the extension cord shall be equal to or greater than the electrical rating of the appliance,

– OR –

2. Do not use an extension cord. If the power supply cord is too short, have a qualified electrician or serviceman install an outlet near the appliance.

A commercial microwave oven complying with the Exception No.2 to 38.1, shall have instructions that contain the statement “Warning: Risk of Electric Shock. If the cord or plug becomes damaged, replace only with a cord and plug of the same type”.

- x DO NOT use an extension cord. If the power cord is too short, have a qualified electrician or serviceman install an outlet near the appliance.

 **WARNING:** Improper grounding can result in risk of electric shock.

## POWER CORD REPLACEMENT OR REMOVAL

If the power cord is damaged, it must be replaced by the manufacturer, its service agent, or a similarly qualified person.

 **WARNING:** If the oven is unplugged during service or maintenance, the user must be able to access and see the plug at all times to ensure that the oven remains unplugged. The plug must remain near the oven and cannot be placed behind another appliance or in another room.

## SAVE THESE INSTRUCTIONS

## PRECAUTIONS TO AVOID POSSIBLE EXPOSURE TO EXCESSIVE MICROWAVE ENERGY

- (a) Do not attempt to operate this oven with the door open since open-door operation can result in harmful exposure to microwave energy. It is important not to defeat or tamper with the safety interlocks.
- (b) Do not place any object between the oven front face and the door or allow soil or cleaner residue to accumulate on sealing surfaces.
- (c) Do not operate the oven if it is damaged. It is particularly important that the oven door close properly and that there is no damage to the: (1) Door (bent), (2) hinges and latches (broken or loosened), (3) door seals and sealing surfaces.
- (d) The oven should not be adjusted or repaired by anyone except properly qualified service personnel.

## RF INTERFERENCE CONSIDERATIONS

This oven generates radio frequency signals. This device has been tested and was determined to be in compliance with applicable portions of FCC part 18 requirements and to the protection requirements of Council Directive 89/336/EEC on the approximation of the laws of the Member States relating to electromagnetic compatibility at the time of manufacture. However, some equipment with sensitivity to signals below these limits may experience interference.

If your equipment experiences interference:

- ✓ Increase the physical separation between this oven and the sensitive equipment.
- ✓ If the sensitive device can be grounded, do so following accepted grounding practices.
- ✓ If battery-powered microphones are being affected, ensure that the batteries are fully charged.
- ✓ Keep sensitive equipment on separate electrical circuits if possible.
- ✓ Route intercom wires, microphone wires, speaker cables, etc. away from the oven.

## PROTECTIVE EARTH (GROUND) SYMBOL



This symbol identifies the terminal which is intended for connecting an external conductor for protection against electric shock in case of a fault, or the terminal of a protective earth (ground) electrode.

## EQUIPOTENTIAL BONDING SYMBOL



This symbol identifies the terminals which, when connected together, bring the various parts of an equipment or of a system to the same potential, not necessarily being the earth (ground) potential, e.g. for local bonding.

**SAVE THESE INSTRUCTIONS**

This page intentionally blank.

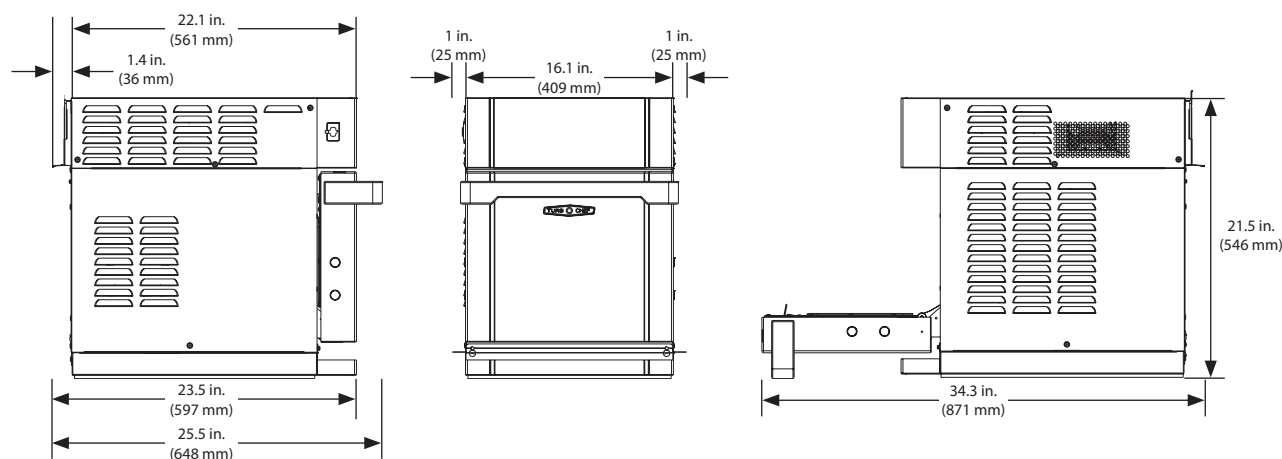

Figure 1: Eco Oven Dimensions

## Theory of Operation

Utilizing TurboChef's patented technology to rapidly cook food without compromising quality, the Eco oven provides superior cooking performance while requiring minimal space and energy consumption. The control system precisely coordinates impinged airflow with top-launched microwave to deliver product-specific results, and integral catalytic converters allow for UL®-certified ventless operation (see page 5 for details).

This manual includes instructions for installing, cleaning, and operating the Eco oven. If you have questions that are not addressed in this manual, contact Customer Support at 800.90TURBO (+1 214.379.6000) or your Authorized Distributor.

## Features

- High-contrast, durable capacitive touch screen
- Manual mode for on-the-fly cooking
- Up to 10 selectable languages
- 13, 16, or 20-amp, Single Phase models available
- Menu editing tools and USB detection
- WiFi/Middleby Connect™ ready for the connected kitchen

## Dimensions

### Oven Dimensions

Height: 21.5" (546 mm)  
 Width (Base): 16.1" (409 mm)  
 Width (Overall): 18.1" (460 mm)  
 Depth (Footprint): 22.1" (561 mm)  
 Depth (Overall): 23.5" (597 mm)  
 Depth (Door open): 34.3" (871 mm)

### Oven Weight

118 lbs. (54 kg)

### Cook Cavity Dimensions

Height: 7.2" (183 mm)  
 Usable Height: 5.7" (145 mm)  
 Width: 12.5" (318 mm)  
 Depth: 10.5" (267 mm)  
 Usable Depth: 9.3" (236 mm)  
 Volume: 0.54 cu ft (15.3 liters)  
 Usable Volume: 0.38 cu ft (10.1 liters)

### Clearances

Top: 5" (127 mm)  
 Sides: 2" (51 mm)

## Certifications



cULus, UL EPH, TÜV, CE, FDA

## Oven Construction

### Exterior

- 430 stainless steel outer wrap and door
- Cool-to-touch exterior; all surfaces below 50°C
- Ergonomic door handle

### Interior

- 201/304 stainless steel
- Fully welded and insulated cook chamber
- Removable rack and lower jetplate

## Electrical Specifications - Single Phase

TurboChef recommends a Type D circuit breaker for all installations outside the United States.

### US/Canada

208/240 VAC, 60 Hz, 20 Amps,  
Max Input 3.6 kW, MW 2 kW,  
Heaters/Blowers 4.0 kW\*\*

### International (AK)

240 VAC\*, 50 Hz, 19 A  
Max Input 3.5 kW, MW 2.0 kW,  
Heaters/Blowers 4.0 kW\*\*

### International (BK)

220 VAC, 60 Hz, 20 A  
Max Input 3.6 kW, MW 2.0 kW,  
Heaters/Blowers 4.0 kW\*\*

### International (EU)

230 VAC, 50 Hz, 16 A  
Max Input 3.3 kW, MW 2.0 kW,  
Heaters/Blowers 3.7 kW\*\*

### International (LA)

220 VAC, 60 Hz, 20 A  
Max Input 3.6 kW, MW 2.0 kW,  
Heaters/Blowers 4.0 kW\*\*

### International (UK)

230 VAC, 50 Hz, 13 A  
Max Input 2.6 kW, MW 2.0 kW,  
Heaters/Blowers 2.9 kW\*\*

### Japan (JK)

200 VAC, 50 or 60 Hz, 20 A  
Max Input 3.5 kW, MW 2.0 kW,  
Heaters/Blowers 4.0 kW\*\*

### International (SK)

230 VAC, 60 Hz, 16 A  
Max Input 3.3 kW, MW 2.0 kW,  
Heaters/Blowers 3.7 kW\*\*

\* US/Canada models include a voltage sensor that detects 208 or 240 VAC, but does not compensate for lack-of or over-voltage installations.

\*\* Under normal operation, the oven will not exceed the max input value.

## Installation

Install or locate this appliance only in accordance with the instructions below.

### Unpacking Instructions

1. Remove the oven from its packaging.
2. Before discarding, check the packaging thoroughly for accessories and literature.

NOTE: Packaging may also be retained in case the oven may at some point be shipped somewhere else or returned to the manufacturer.

3. Check the cook cavity thoroughly for accessories and literature.
4. Discard any packaging in the cook cavity.

### Installation Warnings - Read Before Lifting Oven

**⚠ WARNING:** The Eco oven weighs approximately 118 lb. (54 kg). TurboChef recommends lifting the oven with no fewer than two people.

**⚠ WARNING:** Never lift the oven from the front and rear or by the door handle. Doing so will cause the door to misalign, resulting in a non-warranty service call.

**⚠ WARNING:** The oven must be properly placed on a food station at all times. TurboChef will not recognize a fallen oven as a warrantable claim and is not liable for any injuries that may result.

**⚠ WARNING:** This oven is not intended for built-in installation (i.e., installing the oven in any structure that surrounds the oven by five or more sides). Be sure to provide a minimum of 2" (51 mm) clearance for all sides and 5" (127 mm) clearance for the top.

**⚠ WARNING:** This oven is intended to be stacked only with appropriate hardware. Never stack any more than two high.

### Lifting and Placing the Oven

1. Prepare a surface at least 23.5" (597 mm) deep and capable of supporting 120 lb. (54 kg).
2. Position one or more persons at the left and right sides of the oven.
3. Place hands under the oven and lift.
4. Place the oven on the prepared surface, ensuring no edges are hanging off the sides.
5. If stacking two ovens:
  - a. See page 1 for dimensions.
  - b. Install the stacking bracket (part number ECO-9420) to the lower oven.
  - c. Place the upper oven on top of the lower oven.
  - d. Secure the bracket to the top oven.

6. Ensure the oven rack is properly installed (attached to the bottom jetplate).
7. Ensure the lower panel (crumb tray) is attached below the oven door.
8. Plug in the oven.

**NOTE:** The oven is primarily serviced through its top. **DO NOT** install shelving directly over the unit. The operator will be responsible for service charges incurred as a result of added time required to access the top of the oven.

### Installation Near Open Heat Source

When placing a TurboChef oven near an open heat source (Figure 2), strictly adhere to the following:

- If the oven is being placed near a grill or stove, a divider must exist between the oven and the open heat source, with a minimum of 6" (153 mm) between the oven and the divider.
- If the oven is being placed near a fryer, a divider must exist between the oven and fryer, with a minimum of 12" (305 mm) between the oven and the divider.
- The height of the divider must be greater than or equal to the height of the oven, 21.5" (546 mm).
- Verify the oven location has a minimum 5" (127 mm) clearance on top and a minimum 2" (51 mm) clearance on each side.

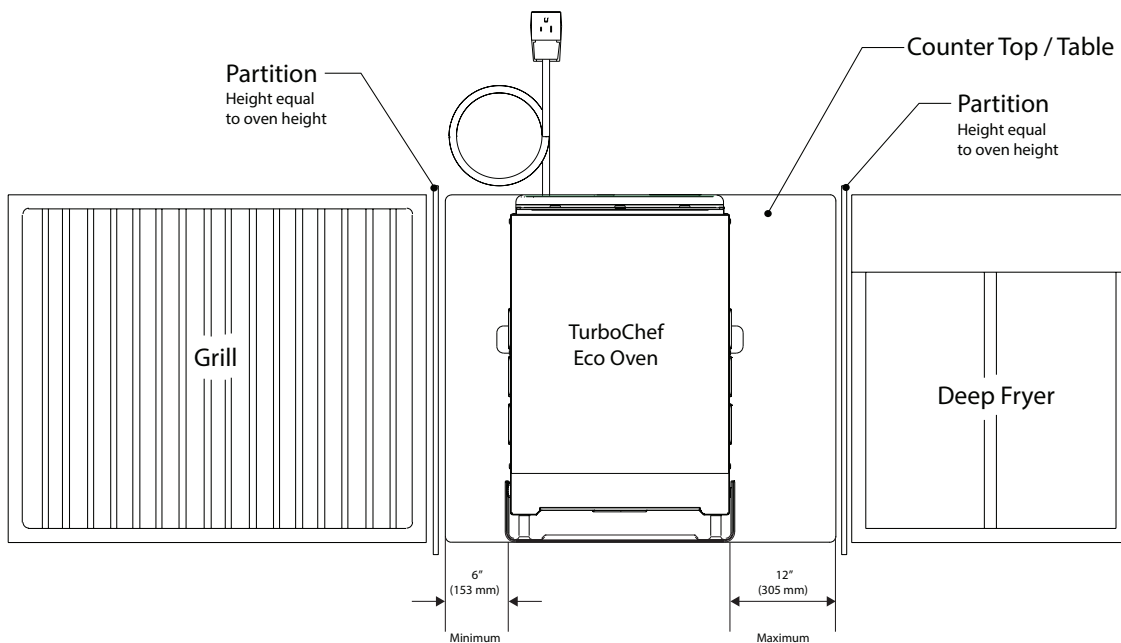

Figure 2: Installation Near Open Heat Source

## Oven Restraint Kit

Part Number: TC3-0242



**WARNING:** The Oven Restraint Kit will not prevent the oven from falling off a countertop if the oven is pulled off or allowed to slide off the edge. Installation instructions are included with the kit.

## ChefComm Pro

Part Number: CON-7006

ChefComm Pro® lets you easily create menu settings on a computer and upload them to an oven via USB. For more information, call TurboChef Customer Support at 800.90TURBO or +1 214.379.6000.

## Middleby Connect™

Middleby Connect™ is more than just another piece of WiFi-compatible kitchen equipment. It is a robust enterprise system for developing recipes, updating your oven settings, interpreting oven data, and much more. Middleby Connect™ also enables predictive servicing and maintenance of ovens. It is available for the Double Batch, Single Batch, Bullet, Eco, i1 (Sóta, Panini, Waterless Steamer), i3, and i5 ovens with Touch Controls, as well as other Middleby brand equipment.

## Date and Time Prompt

The oven maintains a data log that contains valuable information about the operation of the oven, including faults, items cooked, and other events. An accurate date and time are important for the data log. If the oven loses the date and time as a result of prolonged disconnection from power, a prompt will alert the operator to set the date and time. The prompt will only occur once. If bypassed, the operator must update the date and time from the Info Mode Settings screen (see page 14 for details.)

## Registration Prompt

At the time the oven is installed, registration information should be input into the oven including store number, address, et cetera. This information is important for warranty tracking purposes. If registration information is not entered, you may be prompted by the oven to input the registration information whenever the oven is turned on at the start of the day. To eliminate the prompts, simply fill in the registration information requested at the prompt screen.

## Voltage Selection

For North America oven models, the oven will detect 208 or 240 incoming voltage.

If incoming voltage for the store is different than the factory-preset voltage, the operator will be required to select either 208 or 240. The correct voltage will be enlarged on the screen, identifying which option to touch (see Figure 3 below).



Figure 3: Selecting Voltage



## Ventilation

The TurboChef Eco oven has been approved by Underwriter's Laboratory for ventless operation (UL KNLZ listing) for all food items except for foods classified as "fatty raw proteins." Such foods include bone-in, skin-on chicken, raw hamburger meat, raw bacon, raw sausage, steaks, etc. If cooking these types of foods, consult local HVAC codes and authorities to ensure compliance with ventilation requirements.

To ensure continued compliance with all health, building, and fire codes, you are required to maintain clean and sanitary conditions around your oven at all times.

NOTE: In no event shall the manufacturer assume any liability for damages or injuries resulting from installations which are not in compliance with the instructions and codes previously listed. Failure to comply with these instructions could result in the issuance of a temporary cease and desist order from the local health department until the environment concerns are addressed.

## Daily Maintenance

Follow the steps below when cleaning your Eco oven. Use only TurboChef®-approved cleaning chemicals. The use of any other cleaning products may damage critical oven components, resulting in a non-warranty service call.

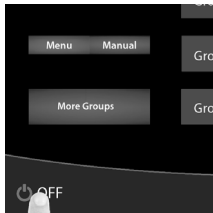

Step 1

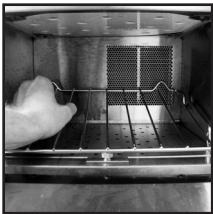

Step 2 (Fig A)

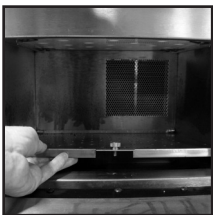

Step 2 (Fig B)



Step 4



Step 5

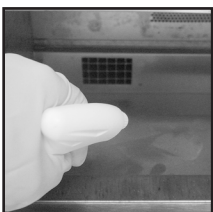

Step 6

## Supplies and Equipment

TurboChef® Oven Cleaner (Product Number: 103180), TurboChef® Oven Guard (Product Number: 103181), Kay ClickSan® sanitizer, nylon scrub pad, cleaning towel, disposable gloves, protective eyewear, dust mask (optional)

### Step 1: Prepare the Oven

**⚠ WARNING:** The oven operates at approximately 500°F (260°C) and may cause injury if not allowed to cool properly.

- Turn off the oven by touching the Off icon.
- Slightly open the oven door.
- Cooling takes approximately 30 minutes. **DO NOT** clean the oven until the oven displays “ready to clean.”

### Step 2: Remove the Wire Rack and Lower Jetplate

**⚠ WARNING:** Be sure the oven interior is cool before removing these items.

- Lift the rear of the rack up and slide it upward to the back of the oven to remove (Fig. A).
- Loosen the bottom jetplate thumbscrew.
- Lift the front of the bottom jetplate and pull it out from the cavity (Fig. B).

**⚠ CAUTION:** **DO NOT** remove the top glass jetplate; breakage will result in a non-warranty service call.

### Step 3: Clean the Wire Rack and Lower Jetplate

- Wash, rinse, sanitize, and dry the rack and jetplate.

### Step 4: Clean the Air Filter

**⚠ CAUTION:** TurboChef does not recognize blocked air vents as a warrantable claim. The filter must be cleaned regularly or replaced if damaged. During oven operation, the filter must remain in place at all times.

- Remove the air filter from the back of the oven.
- Rinse the air filter with hot water.
- Allow the air filter to dry completely.

**⚠ CAUTION:** **DO NOT** operate the oven without the air filter in place.

### Step 5: Wipe the Oven Interior

- Use a food vacuum or damp towel to remove large particles from the oven cavity.

### Step 6: Clean the Oven Interior

- Spray TurboChef Oven Cleaner onto the top, bottom, and sides of oven interior.

**⚠ CAUTION:** **DO NOT** spray Oven Cleaner into the holes on the back oven wall. Doing so can damage critical oven components, resulting in a non-warranty service call.

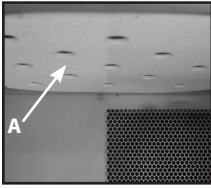

Step 6

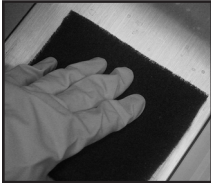

Step 7

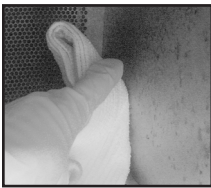

Step 8



Step 9



Step 10



Step 11

### Step 6: Clean the Oven Interior, Continued

- Allow Oven Cleaner to penetrate stains for five minutes.
- Clean the oven interior with a nylon scrub pad.

**⚠ CAUTION: DO NOT** attempt to scrub the upper jetplate (A). If food is stuck to the oven ceiling, gently remove it without applying pressure to the glass plate. Breakage will result in a non-warranty service call.

**⚠ CAUTION: DO NOT** remove the top glass jetplate (A); breakage will result in a non-warranty service call.

### Step 7: Clean and Dry the Oven Door

- Clean the oven door with Oven Cleaner and a nylon scrub pad.
- Wipe the oven door with a damp towel, and then a dry towel.

### Step 8: Rinse or Wipe the Oven Interior

**⚠ CAUTION: DO NOT** use a hose or water jet for cleaning. Doing so can damage critical oven components, resulting in a non-warranty service call.

- Wipe down the oven interior with a clean damp towel.
- Remove the lower tray and remove large food particles.
- Wipe the tray with a clean, damp towel.
- Dry the oven interior with a clean towel.

### Step 9: Apply TurboChef Oven Guard

- Spray TurboChef Oven Guard onto a clean towel.
- Wipe the interior walls and the inside of the oven door.

**⚠ CAUTION: DO NOT** spray Oven Guard into the cavity, especially around the holes on the back oven wall. Doing so can damage critical oven components, resulting in a non-warranty service call.

### Step 10: Reinstall Components

- Reinstall the lower jetplate and tighten the thumbscrew.
- Reinstall the wire rack.
- Close the oven door.
- Reinstall the filter, or replace it with a new one if the mesh is deteriorated, has large openings, or has started to dislodge from the frame.

### Step 11: Clean the Oven Exterior

- Wipe the oven exterior with a clean, damp towel.

**⚠ CAUTION: DO NOT** spray chemicals into any openings, such as the louvers on the side panels or the rear vent catalyst housing. Doing so can damage critical oven components, resulting in a non-warranty service call.

- The oven is ready to turn on.

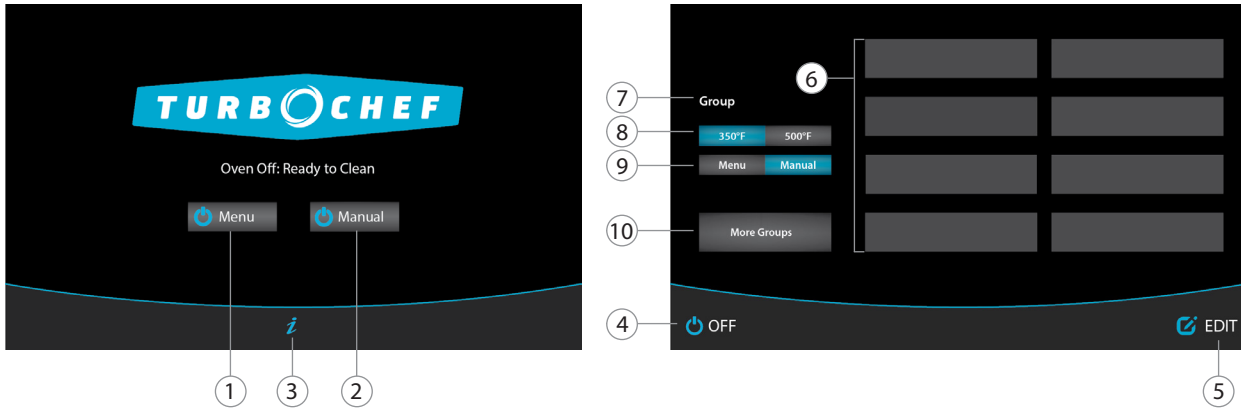

Figure 4: Oven Controls

NOTE: Display options vary depending on which features are enabled.

## Oven Controls

### 1. Menu Icon/Temperature Icon

Touch to turn the oven on and cook in menu cook mode (page 9).

NOTE: If Manual Mode is disabled, a temperature icon will be shown instead of the menu icon.

### 2. Manual Icon

Touch to turn the oven on and cook in manual cook mode (page 12). The Manual icon is only present if enabled (page 14).

### 3. “i” Icon

Touch to access Info Mode (page 13). The “i” icon is only displayed when the oven is off, or cooling down.

### 4. Off Icon

Touch to turn the oven off (cool down).

### 5. Edit Icon

The Edit icon will only be displayed when Edit Mode (page 19) is enabled. Touching this icon will allow you to edit existing menu items.

### 6. Groups/Items (1-8 and 9-16)

The oven contains 16 food groups divided into 2 groups of 8. Each food group contains 16 items divided into 2 groups of 8.

### 7. Group Name

When viewing items, the group name indicates which group is being displayed.

### 8. Set Temperature Toggle

The set temperature toggle will only be displayed when operating with two different set temperatures. Touch the toggle to view groups from the other set temperature.

### 9. Menu/Manual Toggle

The Menu/Manual toggle will only be displayed when manual cooking is enabled and will allow you to switch between menu mode (page 9) and manual cook mode (page 12).

### 10. More/Previous Groups or Items

This icon will only be displayed when using one set temperature. To view additional groups or items, touch “More Groups” or “More Items.” Or, if on screen two, touch “Previous Groups” or “Previous Items.”

## Menu Cook Mode

The oven is preprogrammed with recipe settings at the time of manufacture and is ready to operate out of the box. New menu settings can be loaded via USB (page 17), programmed manually (page 19) or via Middleby Connect™ (page 4).

If settings are not present, the oven will cook only in manual mode (page 12).

This oven uses impingement and microwave to cook food faster than traditional cooking methods. Air enters the cavity from the top and bottom using a single fan. Because of this design and to ensure uniformity of cooking, the oven must be operated only while the bottom jetplate is in place. While the bottom jetplate is removable for cleaning, it is not removable for cooking. Without the jetplate in place, the oven will not deliver the proper cooking performance to either the top or bottom of the food item. Additionally, a non-warranty service call may result.

The sequence of the steps below may vary, and some may not apply.

### Step 1: Touch “Menu” or the Oven Set Temperature Icon to Turn the Oven On

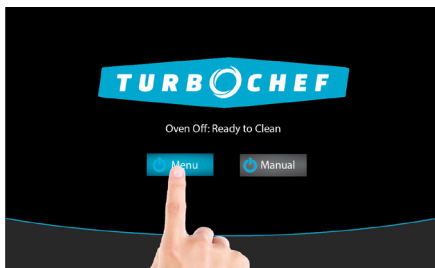

### Step 2: Select Cook Temperature



NOTE: If the temperatures are the same, or if Manual Mode is disabled, this screen will be bypassed.

### Step 3: Warming Up

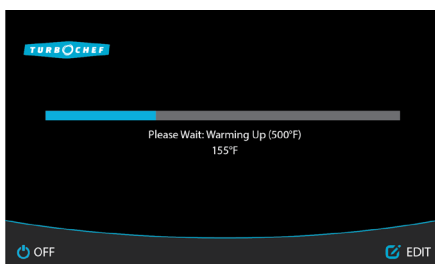

NOTE: When the oven is done warming up, it will “soak” for an additional eight minutes. “Soaking” ensures the cavity surfaces absorb enough heat so that cooking will not be affected.

#### Step 4: Place Food in the Oven

 **WARNING:** Inside of oven and oven door are hot!

#### Step 5: Select a Group

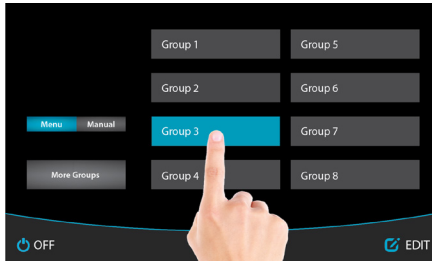

NOTE: Touch “More Groups” to view additional groups.

#### Step 6: Select an Item



NOTE: Touch “More Items” to view additional items.

#### Step 7: Cooking

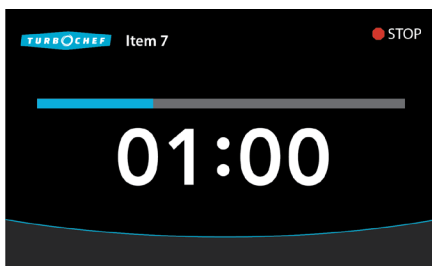

NOTE: To immediately terminate a cook cycle, touch “STOP.”

NOTE: If the oven door is opened during a cook cycle, the cycle will pause until the door is closed. Touch “YES” to resume.

#### Step 8: Check/Remove Food from Oven

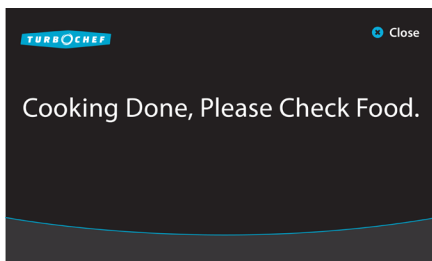

 **WARNING:** Dish/inside of oven and door are hot!

### Step 9: Cook More / Brown More / Cook & Brown More



NOTE: This option must be enabled in order to cook an item beyond its original cook time (see page 14 for details).

To cook an item longer than its original cook time, touch one of the icons on the screen:

- Touch “Cook More” if the inside of the food item requires cooking.
- Touch “Brown More” if the outside of the food item requires browning or crisping.
- Touch “Cook & Brown More” if both the inside and outside of the food item require cooking.

Selecting one of these options will cook the item for 20% of the last cook time selected. The minimum cook time is the fewer of 15 seconds or the entire original cook cycle. The maximum cook time is one minute. The oven will cook at the settings listed below:

- Cook More: 10% air, 100% microwave
- Brown More: 100% air, 0% microwave
- Cook & Brown More: 100% air, 100% microwave

### Step 10: Cooling Down

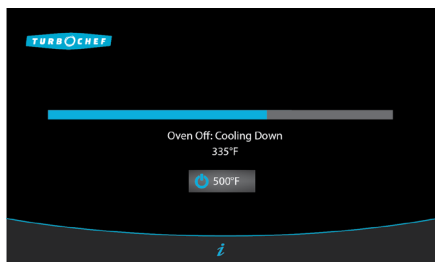

When finished cooking for the day, touch “OFF” to turn the oven off and begin cooling down.

## Manual Cook Mode

Manual Cook Mode allows cooking “on the fly,” whereas Menu Cook Mode (page 9) allows cooking from preset cook settings. To access Manual Cook Mode, touch the Manual icon when the oven is off or cooling down (page 8) or touch the Menu/Manual toggle on the Menu Mode screen.

NOTE: If the “Manual” icon is not present, see page 14 to make it appear.

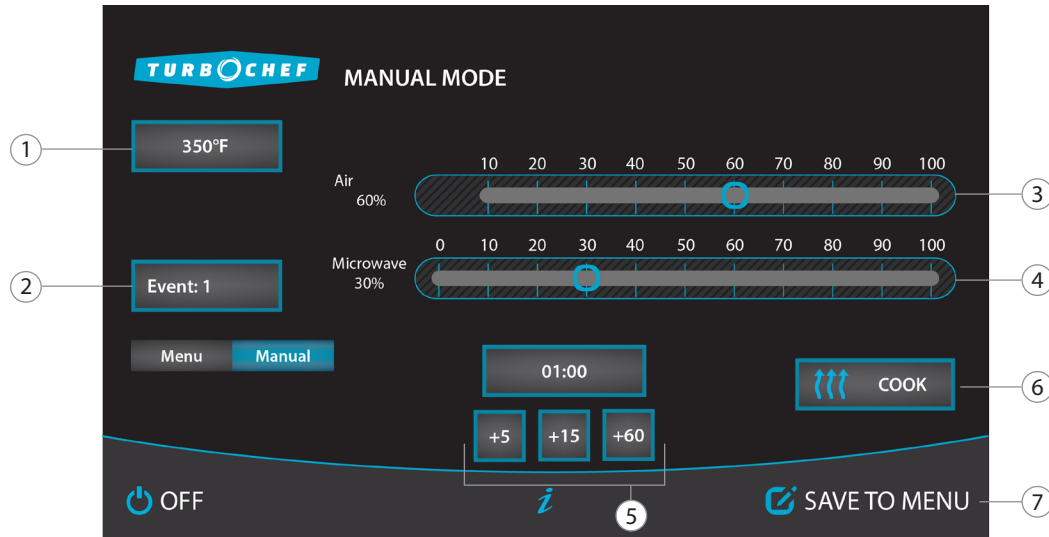

### 1. Set Temperature

Touch to change the set temperature. The temperature range is 300–540°F (149–282°C).

### 2. Events

Manual Mode can store six unique cook settings, called events. Touch “Events” to view settings for events 1 through 6.

### 3. % Air

% Air determines the amount of airflow. The more air, the more the product will brown or crisp. % Air can be set from 10-100% in 10% increments.

### 4. % Microwave

% Microwave determines the amount of microwave, and can be set from 0-100% in 10% increments. For example, 50% means the microwave system will remain on for five continuous seconds for every ten seconds during the cook cycle.

### 5. Time

Time can be set from 0-15 minutes. There are four time icons. The first allows the operator to enter the time manually. The others allow the operator to add time in 5, 15, or 60 second increments.

### 6. Cook

Touch to cook.

NOTE: The oven may require additional warming time before cooking can be performed.

### 7. Save to Menu

If you want to save a manual mode setting into the oven menu, touch “Save to Menu.” All six events will be added together as one menu recipe item, and the cook times for each event will be summed and divided into percentages of one cook cycle.

Continued on next page...



7. Save to Menu, continued

- a. Edit settings, if necessary, by touching the setting you wish to edit. From this screen, the following settings are editable:
  - % Time
  - % Air
  - % Microwave
  - Time
  - Recipe Name

NOTE: For additional instructions for editing settings, see page 23.

- b. Touch “SAVE.”



- c. Select a location for the new menu item by first selecting a group.

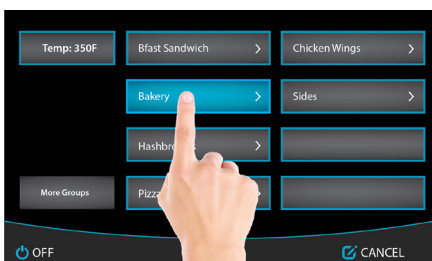

- d. Select an item to overwrite.



Info Mode

To access Info Mode, touch the “i” icon when the oven is off, cooling down, or in manual mode. From the Info Mode screen, access:

- Information
- Counters
- Options
- Settings
- Service
- Manufacturing (MFG)

Info Mode: Information Screen

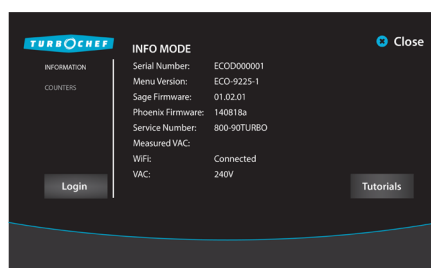

From the Information screen, view the following:

- Serial Number
- Menu Version
- Sage Firmware
- Phoenix Firmware
- Service Number
- Measured VAC (Voltage) - View Incoming
- WiFi Connectivity Status
- Tutorials: View information on installing, operating, and maintaining the oven.

Info Mode: Counters Screen

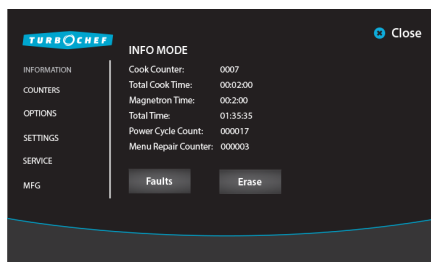

From the Counters screen, view the following in hours or counts:

- Cook Counter
- Total Cook Time
- Magnetron Time
- Total Time (oven on)
- Power Cycle Count: The number of times the oven has cycled power.
- Menu Repair Counter
- Fault log: View time stamps of each fault occurrence and the fault code.

## Info Mode: Options Screen

From the Info Mode Information or Counters screen, touch “Login” to access the Options screen. When prompted, input the password 9 4 2 8 and then touch “ENTER.”



From the options screen, enable/disable

- Editing
- Cook More
- Load Menu
- VAC
- Demo Mode
- Manual Cooking
- Diagnostic Mode
- F2 Bypass

### Editing

Edit Mode shows or hides the button that allows the operator to change menu settings, rename food groups and items, and change the cooking temperature. The Edit icon will be displayed at the bottom of the screen (page 8) when this option is set to YES. See pages 19-27 for more details on editing menu settings.

### Cook More

Cook More controls whether or not the three “cook more” options appear when a cook cycle is done. This option must be enabled in order to cook an item beyond its original cook time. See page 11 for details.

### Load Menu

Load Menu enables or disables USB detection, which allows the operator to upload and/or download new menu settings from USB. Setting Load Menu to NO will prevent the operator from loading a menu. See page 17 for more details.

### VAC

When VAC is set to YES the incoming voltage will be displayed on the Info screen. This is set by the factory and should not be changed.

### Demo Mode

Demo Mode is a feature used to demonstrate the cooking features of the oven without turning on the heaters or microwave system. Demo Mode must be set to NO during regular operation.

### Manual Cooking

When Manual Cooking is set to YES, the operator can cook items “on the fly.” See page 12 for more details.

### Diagnostic Mode

Diagnostic Mode allows the operator to view and test oven components. This mode should only be used by qualified service technicians, unless otherwise instructed by TurboChef.

### F2 Bypass

The F2 alarm indicates the oven temperature is too low. YES means the oven will not terminate a cook cycle when an F2 alarm is encountered so the food product can finish cooking. The oven will still log the fault condition. NO means the oven will function as it normally would; i.e., when an F2 alarm is discovered during a cook cycle, the oven will terminate the cook cycle.

## Info Mode: Settings Screen

From the Information or Counters screen, touch “Login” to access the Settings screen. When prompted, input the password 9 4 2 8 and then touch “ENTER.”

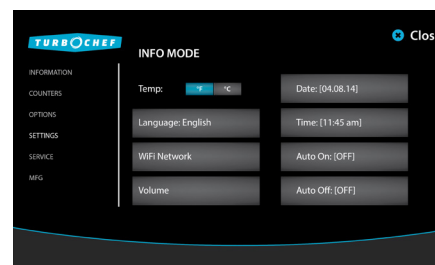

From the settings screen, set

- Temperature Measurement
- Language
- WiFi Network
- Sound Volume
- Date
- Time
- Auto On
- Auto Off

## Temperature Measurement

The temperature measurement setting is configured at the factory. Touch °F (Fahrenheit) or °C (Celsius) to change the temperature measurement settings.

## Language

The default language is English. To change to another language, touch “Language: English” and then touch the preferred language and touch “ENTER.” The available languages are:

- French
- German
- Polish
- Portuguese
- Spanish

The available languages may also be:

- Chinese
- Korean
- Japanese
- Russian
- Dutch

## WiFi Network

NOTE: Feature or service may not be available.

Connecting the oven to a WiFi network and utilizing TurboChef’s connectivity services, such as Middleby Connect™ (page 4) will allow you to remotely update the menu and firmware for one or all of your ovens and will enable access to reporting tools and live data streams to view what is being cooked and when.

Special instructions for corporate/chain customers may be required. Contact your facility administrator for more information.

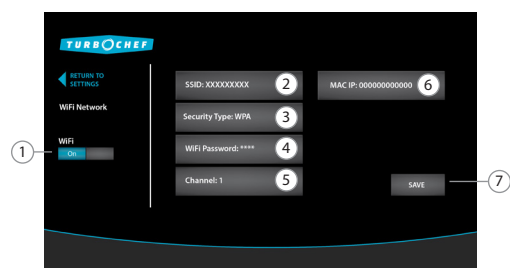

From the WiFi Network setup screen (above), the following information may be entered to configure the oven for networking:

- WiFi On/Off
- SSID
- Security Type
- WiFi Password

### 1. WiFi On/Off

Toggle this option to enable/disable the oven’s WiFi capabilities.

### 2. SSID

The SSID is the case sensitive name of the WiFi network that you wish the oven to join. After touching the SSID icon, use the on-screen keyboard to either select from a list of broadcast SSIDs, or type in the WiFi network name and touch Enter.

If you are unsure of the SSID for the network, contact your network administrator.

### 3. Security Type

The Security Type is set by your WiFi router. After touching “Security Type,” match one of the four displayed security types to the one your router is using by selecting one of the following options from the screen: Open, WPA, WPA2, WEP.

After selecting the correct Security Type, touch Enter.

If you are unsure of the Security Type used by the network, contact your network administrator. In some instances, the Security Type may be printed on a label on the bottom of your WiFi router.

### 4. WiFi Password

The WiFi Password is the case sensitive password needed to join the WiFi network. After touching the WiFi Password icon, use the on-screen keyboard to type in the WiFi network password and touch Enter.

If you are unsure of the WiFi Password for the network, contact your network administrator.

NOTE: “Open” networks do not use WiFi passwords. Clear or leave this field empty when using the oven on an “Open” network.

Continued on next page...

## 5. Channel

The Channel is determined and assigned by the WiFi router.

NOTE: If you are experiencing difficulty obtaining or keeping WiFi connectivity, TurboChef recommends setting the WiFi router's channel to 1.

Change the network channel by logging into your router. For help with your WiFi router, contact your network administrator.

## 6. MAC IP

The MAC IP is automatically assigned.

## 7. SAVE Button

After entering or updating any of the settings on the WiFi Network screen, press the SAVE button.

 Failure to press the SAVE button will result in the loss of any changes that have been made.

## Ensuring Connectivity

Verify if the oven is connected from the Info Mode: Information screen on page 13.

For help determining the correct network setup information, contact your network administrator.

If MAC IP is blank, the oven may not be configured properly to connect to a WiFi network. Call TurboChef Customer Support at 800.90TURBO or +1 214.379.6000.

## Sound Volume

Touch "Volume" and use the plus or minus icons or slider to increase or decrease the oven sound.

## Date

An accurate date is important for using "auto-on" and "auto-off" (see adjacent). It also helps ensure the accuracy of diagnostics and fault condition reporting.

NOTE: The oven may not retain the date if left unplugged for a prolonged period of time (more than several hours).

To set the date, touch "Date." Enter the date in the following format - MM/DD/YY. Touch "ENTER" to save the changes.

## Time

An accurate time is important for using "auto-on" and "auto-off" (see below). It also helps ensure the accuracy of diagnostics and fault condition reporting.

NOTE: The oven may not retain the date if left unplugged for a prolonged period of time (more than several hours).

NOTE: The clock will not automatically update for Daylight Savings Time.

To set the time, touch "Time." Enter the time in 24-hour format (8:30 p.m. = 20:30). Touch "ENTER" to save the changes.

NOTE: The user interface will automatically convert the time to 12-hour format.

## Auto On

"Auto On" is a feature that turns the oven on automatically at a specific time of day.

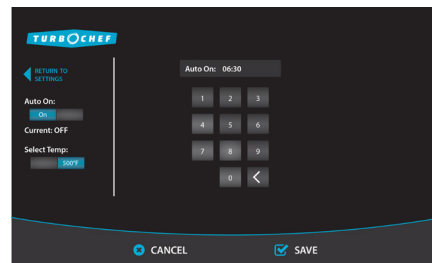

1. To set auto-on, ensure the time of day is accurate (above).
2. Toggle the yes/no icon to the YES position to enable Auto On.
3. Select the temperature to which the oven will automatically heat up.
4. Enter the time in 24-hour format (8:30 p.m. = 20:30). Touch "SAVE" to save all changes.

NOTE: The time will automatically convert to 12-hour format when saved.

## Auto Off

“Auto Off” is a feature that turns the oven off automatically at a specific time of day.

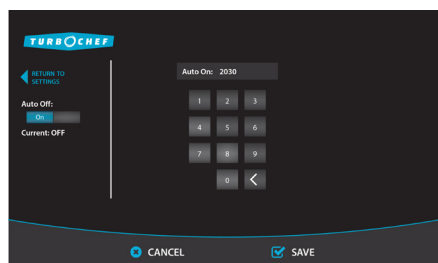

1. To set auto-off time, ensure the time of day is accurate (page 16).
2. Toggle the yes/no icon to the YES position to enable Auto Off.
3. Enter the time in 24-hour format (8:30 p.m. = 20:30). Touch “SAVE” to save all changes.

NOTE: The time will automatically convert to 12-hour format when saved.

## Info Mode: Service Screen

Only qualified service technicians should access the service options, unless otherwise instructed by TurboChef.

## Info Mode: Manufacturing (MFG)

Only qualified service technicians should access the MFG options, unless otherwise instructed by TurboChef.

**⚠ CAUTION:** Changing the oven model will result in the oven not cooking properly and a non-warranty service call.

## Load Menu from USB

NOTE: To update a menu, you may need to verify that access to the Load Menu screen is turned on. See page 14 for details.

USB setup: When loading from USB, the menu must be in BIN (binary) format. The files must be loaded on the root of the USB. To obtain the proper binary file, contact your menu administrator, TurboChef Technical Support, or consult your ChefComm Pro® instructions.

To load a menu to the oven,

1. When the oven is off or cooling down, insert the USB (see below). The oven will automatically detect the device. Touch “OK” to proceed.

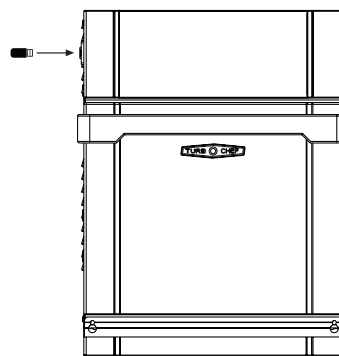

2. Load the menu:
  - a. Touch “Load Menu to Oven.”

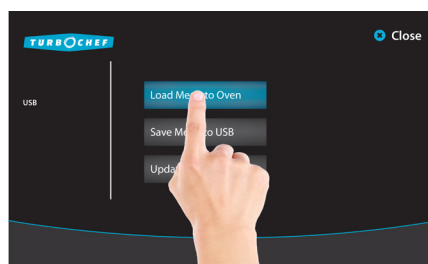

- b. Touch “OK” to confirm the selection and begin the installation.

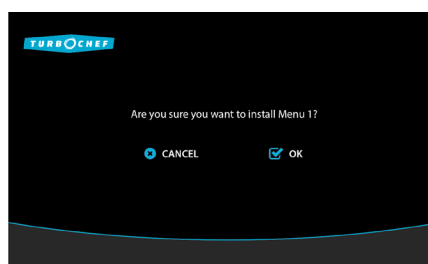

- c. Touch the menu to load.

NOTE: If multiple menus are on the USB, the oven will display the menu names. Otherwise this step will be bypassed.

Continued on next page...

- Once installation is complete, the oven will display “Installation Complete.”

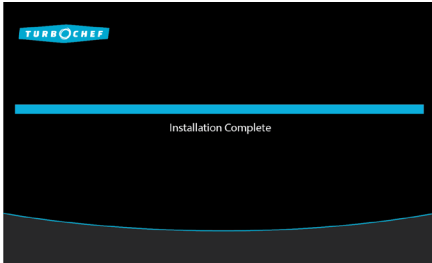

### Save Menu to USB

NOTE: To save a copy of the oven menu, you may need to verify that access to the Load Menu screen is turned on. See page 14 for details.

If desired, name the menu from the Menu Info screen to make it easy to find on your USB drive. See page 14.

- When the oven is off or cooling down, insert the USB (see page 17). The oven will automatically detect the device. Touch “OK” to proceed.
- Touch “Save Menu to USB.”



- Touch “OK” to begin saving the menu to the USB. Touch “CANCEL” to go back to the previous screen.

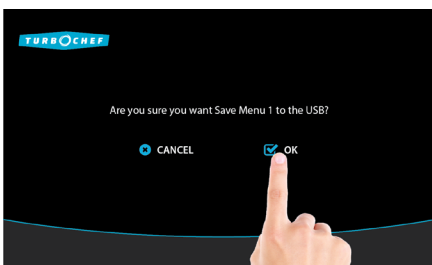

- Once installation is complete, the oven will display “Save Complete.”

NOTE: The menu file will be saved in the root directory on the USB.

### Firmware Update

TurboChef may at some point recommend a firmware update. The update will make sure your oven is operating at its maximum efficiency, but should not affect cooking results or menu settings.

**⚠ CAUTION:** Do not remove the USB until “Installation Complete” is displayed.

- When the oven is off or cooling down, insert the USB (see below). The oven will automatically detect the USB. Touch “OK” to proceed.

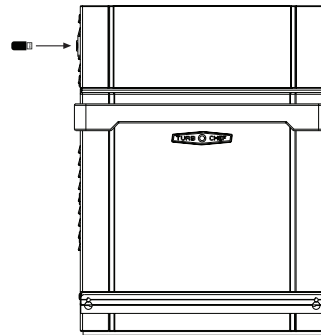

- Load the firmware:
  - Touch “Update Firmware.”

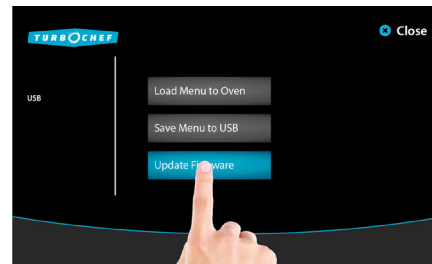

- Touch “OK” to confirm the selection.

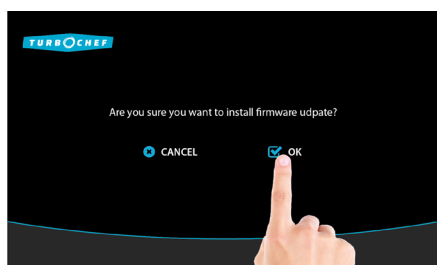

3. The oven will install each firmware file included with the update. Once installation is complete, the oven will display “Installation Complete.”

## Edit Mode

To enable Edit Mode,

1. Touch the “i” icon when the oven is off or cooling down.
2. From the Info Mode screen, touch “Login” to access the Options screen. When prompted, enter the passcode 9 4 2 8 and then touch “Enter.”
3. Set “Editing” to “YES” to enable Edit Mode.

The “Edit” icon will appear at the bottom of the screen in menu mode (see page 8). When “Edit” is touched from the group select screen, the operator can:

- Edit the set temperature
- Access the edit items screen
- Name a group
- Delete a group
- Move a group

When “Edit” is touched from the item select screen, the operator can:

- Edit Settings (page 23)
- Name Item (page 25)
- Change Group (page 26)
- Move Item (page 26)
- Delete Item (page 27)

### Edit Set Temperature

The menu set temperature should never be changed to compensate for over-cooking or under-cooking. If recipe settings are not cooking as desired, consult your menu developer, authorized distributor, or TurboChef Customer Support.

To change a set temperature:

1. Place the oven in Edit Mode.

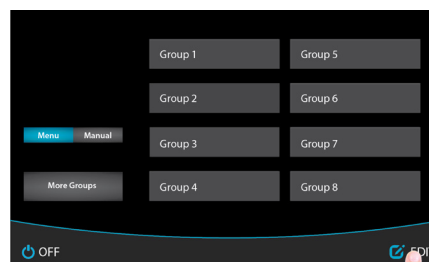

2. Touch the set temperature.

NOTE: The set temperature will apply only to the groups adjacent to it. Be sure to check the temperature for groups 1-8, but also for groups 9-16.



3. Using the number keys, enter the new set temperature. The temperature range is 300–540°F (149–282°C).

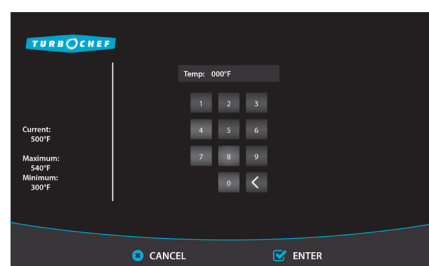

4. Touch “ENTER” to confirm the change.

### Access Edit Items Screen

Item settings can be edited from the Edit Settings screen. See page 23 for more details.

### Name a Group

To name or edit a group name,

1. Place the oven in Edit Mode.

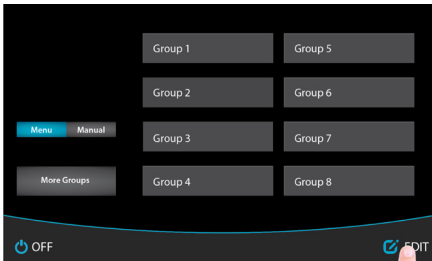

2. Select a Group.

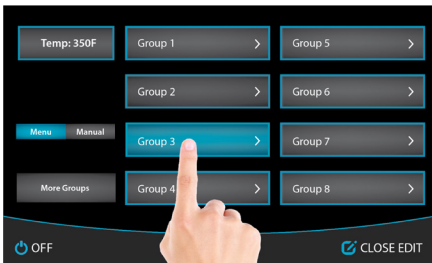

3. Select one of the options:
  - a. To edit a group name, touch “Name Group.”

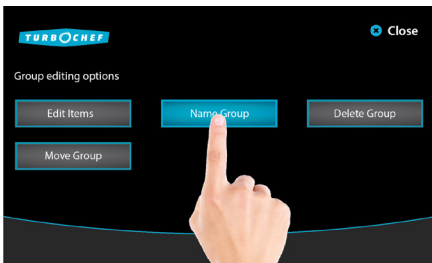

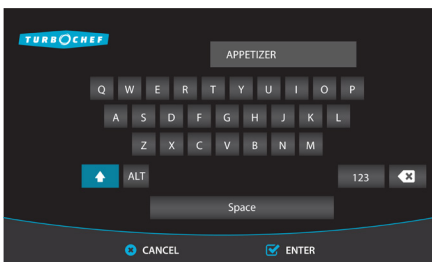

- b. Using the keypad, enter the new group name. Touch “ENTER” to save changes.



NOTE: Touch the “123” icon to access numbers and symbols.

NOTE: Touch the  icon to change case between:

- Uppercase, blue icon 
- Lowercase, gray icon 

NOTE: Touch the Alt icon to show special characters.

### Delete a Group

To delete a group,

1. Place the oven in Edit Mode.

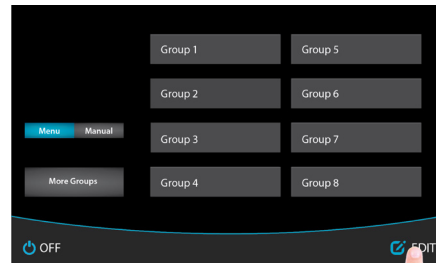

2. Touch the group to delete.



3. To delete a group, touch “Delete Group.”

NOTE: Deleting a group will delete all items in the group.

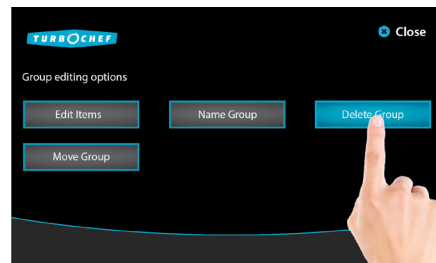



### Move a Group

To move a group to another location,

1. Place the oven in Edit Mode.

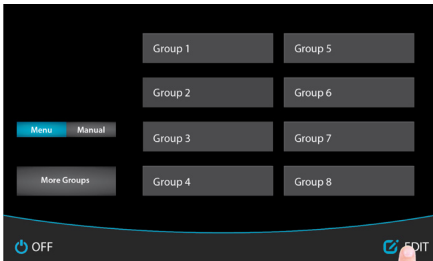

2. Touch the Group to move.

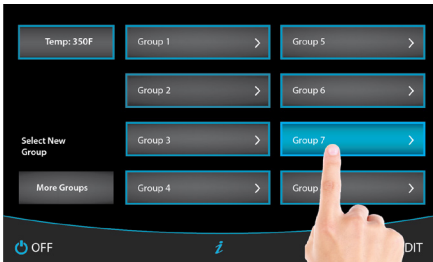

3. Touch "Move Group."

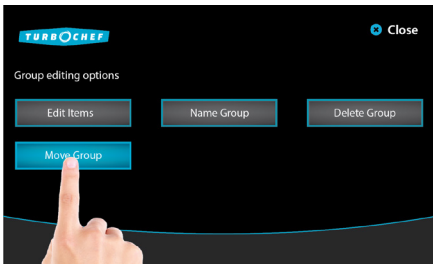

4. The group that is to move will be highlighted blue.



5. Touch the new location for the group.

NOTE: If a group is moved to a space that already contains settings, the old settings in that space will be overwritten.

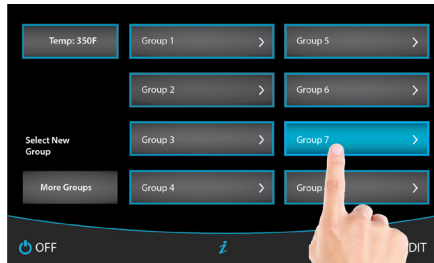

### Item Editing Options

To access the Edit Settings screen,

1. Touch "EDIT" to place the oven in Edit Mode.

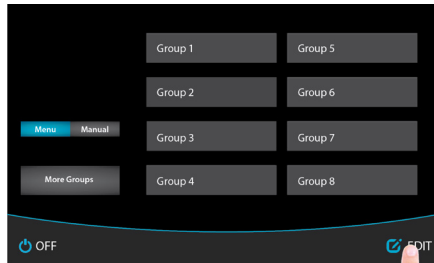

2. Touch the group that contains the item to edit.

NOTE: Accessing Edit Mode from the item select screen, rather than the group select screen, will bypass this step.



Continued on next page...

- From the Group Editing Options screen, touch “Edit Items.”

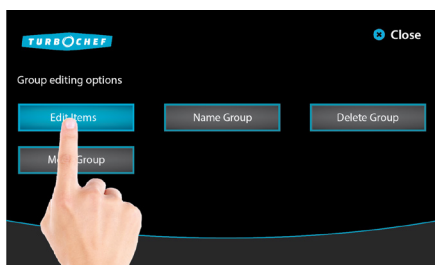

- Touch an item to edit.



- From the Item Editing Options screen, the operator can:
  - Edit Settings (page 23)
  - Name Item (page 25)
  - Change Group (page 26)
  - Move Item (page 26)
  - Delete Item (page 27)

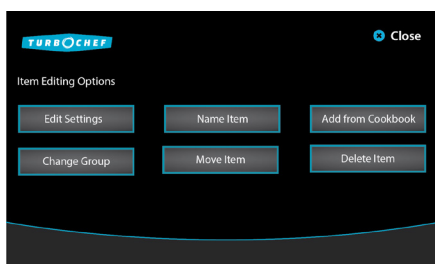

## Edit Settings

### Edit Settings

From the Item Editing Options screen (page 21), select “Edit Settings.”  
From the Edit Settings screen the operator can:

- Edit % Air Time
- Edit % Air
- Edit % Microwave
- Edit Cook Time
- Name an Item
- Run a Test Cook Cycle

### Edit % Time

Touch a % Time icon to change, enter the new percentage, and touch “ENTER.” % Time can be set from 0-100% for each event. The sum of all events must be 100. Once all changes are made, touch “SAVE.”

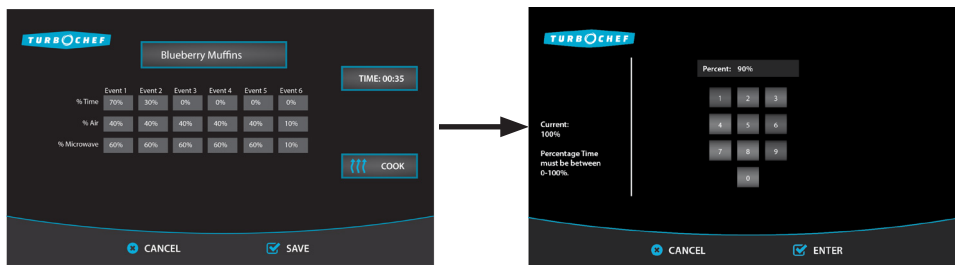

### Edit % Air

Touch the % Air to change and adjust it using the sliding bar that appears below the grid. % Air determines the amount of airflow. The more air, the more the product will brown or crisp. % Air can be set from 10-100% in 10% increments. Once all changes are made, touch “SAVE.”

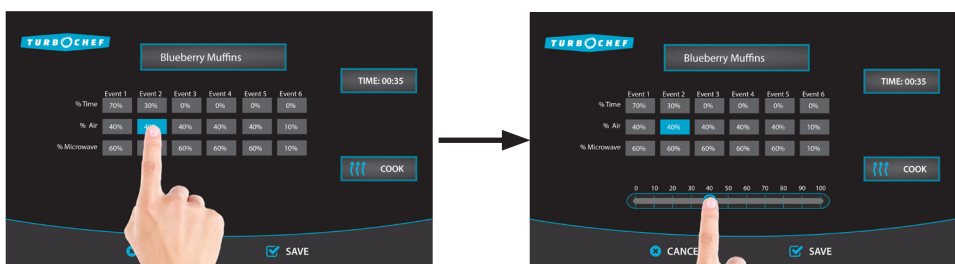

### Edit % Microwave

Touch the % Microwave to change and adjust it using the sliding bar that appears below the grid. % Microwave can be set from 0-100% in 10% increments. For example, 50% means the microwave system will remain on for five continuous seconds for every ten seconds during the cook cycle. Once all changes are made, touch “SAVE.”

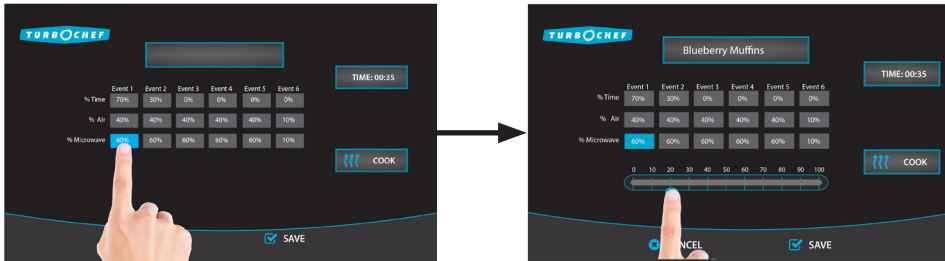

### Edit Cook Time

Touch the current cook time. The maximum allowable cook time is 15 minutes. Using the number keypad, enter the cook time and touch “ENTER.” Once all changes are made, touch “SAVE.”

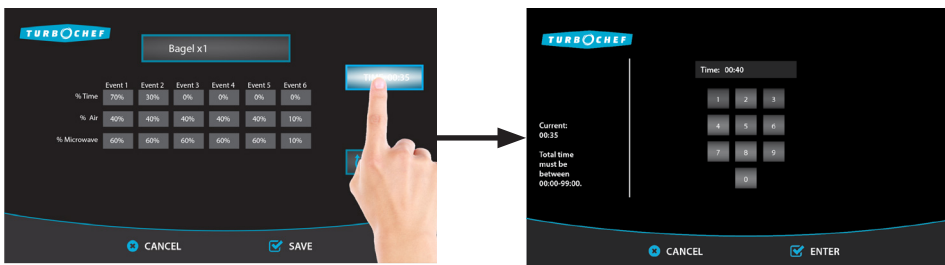

### Name an Item

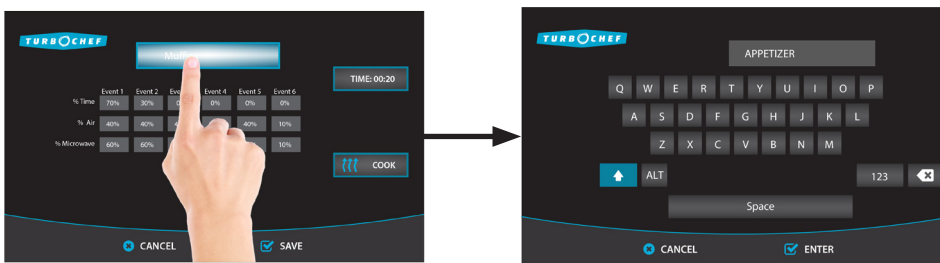

Touch the current name. Using the keypad, input the name and touch “ENTER.” Once all changes are made, touch “SAVE.”



NOTE: The field allows for a maximum of 16 characters.

NOTE: Touch the “123” icon to access numbers and symbols.

NOTE: Touch the  icon to change case between:

- Uppercase, blue icon 
- Lowercase, gray icon 

NOTE: Touch the Alt icon to show special characters.

## Run a Test Cook Cycle

If desired, touch “Cook” to perform a test cook.

NOTE: The oven may require additional warm-up time before a test cook can be performed.



## Name Item

Name Item

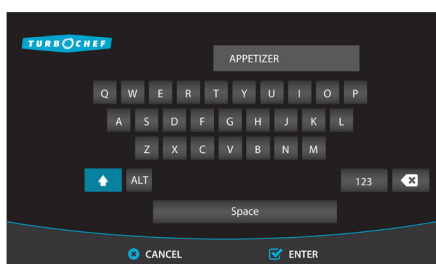

From the “Editing Options” screen (page 21), select “Name Item” to name or edit an item name. After editing the name, touch “ENTER” to save changes.

NOTE: The field allows for a maximum of 16 characters.



NOTE: Touch the “123” icon to access numbers and symbols.

NOTE: Touch the  icon to change case between:

- Uppercase, blue icon 
- Lowercase, gray icon 

NOTE: Touch the Alt icon to show special characters.

## Change Group

Change Group

From the “Editing Options” screen (page 21), select “Change Group.”

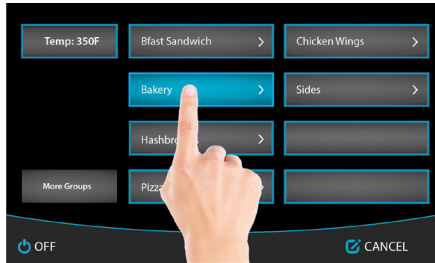

Select a new group.



Touch an item space to indicate where the item will be moved.

NOTE: If an item is moved to a space that already contains settings, the old settings will be overwritten.

## Move Item

Move Item

From the “Editing Options” screen (page 21), select “Move Item.”

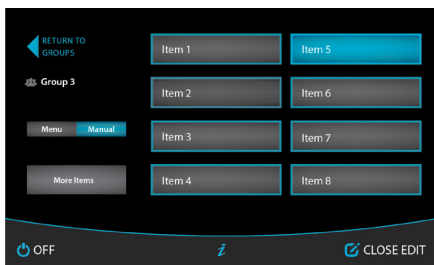

The item that is to move will be highlighted blue.

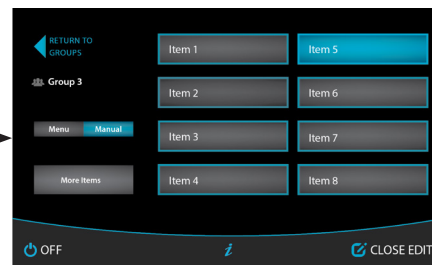

Touch an item space to indicate where the item will be moved.

NOTE: If an item is moved to a space that already contains settings, the old settings will be overwritten.

## Delete Item

Delete Item

From the “Editing Options” screen (page 21), select “Delete Item.” Touch “OK” to delete the item.

NOTE: Once an item is deleted, it cannot be recovered.

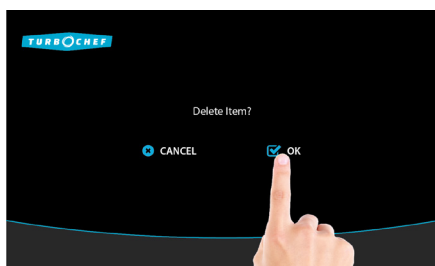

## Troubleshooting

The following is a list of fault codes and error messages, along with the possible problem(s) that the oven may experience. Please attempt the recommended action before calling Customer Support (800.90TURBO, +1 214.379.6000) or your Authorized Distributor.

If any fault or error message occurs that is not listed below, contact Customer Support (800.90TURBO, +1 214.379.6000).

NOTE: Any fault codes listed in **bold** will terminate a cook cycle upon discovery. F6 will not terminate a cook cycle; however, it will alert the user of a possible air circulation problem.

 **WARNING:** Food, oven door, and oven cavity are hot! Use extreme caution when troubleshooting the issues below.

Issue	Possible Cause(s)	Resolution
No power to oven.	<ul style="list-style-type: none"> <li>- Oven is not plugged in.</li> <li>- Main circuit breaker is tripped.</li> </ul>	<ul style="list-style-type: none"> <li>- Plug the oven in.</li> <li>- Verify the wall circuit breaker is on. Reset the breaker, then power the oven back on.</li> </ul>
Oven is not warming up properly.	<ul style="list-style-type: none"> <li>- Oven is in the Off state.</li> <li>- Door is not closed.</li> <li>- Oven has been switched off at the main circuit breaker.</li> <li>- High-limit thermostat tripped</li> </ul>	<ul style="list-style-type: none"> <li>- Touch “Menu” and then a set temperature.</li> <li>- Close the cook cavity door.</li> <li>- Turn the oven off and unplug the oven – leave for two minutes. Re-plug in the oven, switch on the isolator/main power supply, and touch “Menu” and then a set temperature.</li> <li>- Press the button located on the oven rear wall (below the filter) to reset the high-limit thermostat.</li> </ul>
Display reads “Oven Door Open” and alarm sounds.	<ul style="list-style-type: none"> <li>- Food obstruction preventing door from closing.</li> <li>- Oven door is open.</li> <li>- Door switches are out of alignment.</li> </ul>	<ul style="list-style-type: none"> <li>- Open the door and remove the obstruction.</li> <li>- Open and close the door several times.</li> <li>- Call Customer Support.</li> </ul>
Oven is not cooking properly.	<ul style="list-style-type: none"> <li>- Incorrect oven model specified.</li> <li>- Oven is not clean. (Large deposits of grease, carbon, or food debris dilute the microwave.)</li> <li>- Incorrect group and/or item name was selected for the product.</li> <li>- Product was not cooked from correct starting state (for example, chilled or frozen).</li> <li>- Product out of specification.</li> </ul>	<ul style="list-style-type: none"> <li>- From the Info Mode Manufacturing screen, ensure that the oven model is set to “Eco.”</li> <li>- Clean the oven following the cleaning instructions on pages 6-7.</li> <li>- Ensure the correct food group and/or item was selected.</li> <li>- Ensure the product was in the correct state before being placed in the oven.</li> <li>- Ensure the product is exactly the same weight/size as the typical product.</li> </ul>
Oven is not beeping.	<ul style="list-style-type: none"> <li>- Bad boot up when power was cycled.</li> </ul>	<ul style="list-style-type: none"> <li>- Unplug the oven for 30 seconds and plug the oven back in and see if the issue is resolved. If not, call Customer Support.</li> </ul>



Issue	Possible Cause(s)	Resolution
Steam or smoke is present.	<ul style="list-style-type: none"> <li>- Oven is not clean. (Large deposits of grease, carbon, or food debris dilute the microwave.)</li> <li>- Rear vent is clogged.</li> </ul>	<ul style="list-style-type: none"> <li>- Clean the oven following the cleaning instructions on pages 6-7.</li> <li>- Clean the air filter, (step 4, page 6).</li> </ul>
Oven is cooling down, shutting down, or making selections on its own.	<ul style="list-style-type: none"> <li>- Debris is on the display.</li> <li>- F12: Firmware Reboot</li> </ul>	<ul style="list-style-type: none"> <li>- Clean the display.</li> <li>- Check the fault log (see page 13) to see if any F12 faults have been logged. If so, record the Phoenix Firmware version (see page 13) and contact the factory.</li> </ul>
Touch response is slow or not detecting touch at all.	<ul style="list-style-type: none"> <li>- Bad boot up when power was cycled.</li> </ul>	<ul style="list-style-type: none"> <li>- Unplug the oven for 30 seconds and plug the oven back in and see if the issue is resolved. If not, call Customer Support.</li> </ul>
F1: Blower Running Status Bad	<ul style="list-style-type: none"> <li>- Oven power interrupted.</li> </ul>	<ul style="list-style-type: none"> <li>- Verify the wall circuit breaker is on. Reset the breaker and then power the oven on.</li> <li>- Turn the oven off and unplug the oven – leave for two minutes. Re-plug in the oven, switch on the isolator/main power supply, and select “Menu” and then a set temperature.</li> </ul>
F2: Cook Temperature Low	<ul style="list-style-type: none"> <li>- Oven power interrupted.</li> <li>- Air nozzles on the top/bottom of the cook cavity are clogged.</li> <li>- Oven door is out of alignment.</li> <li>- Defective heater.</li> <li>- Blower motor not running.</li> <li>- Oven not fully warmed up.</li> </ul>	<ul style="list-style-type: none"> <li>- Verify the wall circuit breaker is on. Reset the breaker and then power the oven on.</li> <li>- During daily cleaning, make sure to unclog the air nozzles on the top/ bottom of the cook cavity.</li> <li>- Open and close the door several times and verify the door is closed.</li> <li>- Reset the high-limit thermostat located on the oven rear wall (below the filter).</li> <li>- Call Customer Support.</li> <li>- Repeat warmup and allow the oven to idle for five minutes.</li> </ul>
F5: Magnetron Over Temperature	<ul style="list-style-type: none"> <li>- Blockage of cool air into the oven.</li> <li>- Rear cooling fan exhaust guard(s) clogged.</li> </ul>	<ul style="list-style-type: none"> <li>- Remove anything that may be obstructing the flow of cool air into the side/rear oven panels.</li> <li>- Make sure the rear fans are free of debris.</li> </ul>
F6: EC Temp	<ul style="list-style-type: none"> <li>- Blockage of cool air into the oven.</li> <li>- Rear cooling fan exhaust guard(s) clogged.</li> </ul>	<ul style="list-style-type: none"> <li>- Remove anything that may be obstructing the flow of cool air into the side/rear oven panels.</li> <li>- Make sure the rear fans are free of debris.</li> </ul>

# North America Limited Warranty

## TurboChef Eco Rapid Cook Oven – North America

The TurboChef rapid cook oven Limited Warranty outlined below is activated upon shipment of your oven. Should you require additional assistance after reviewing the warranty outlined below, please call TurboChef Customer Support at 800.90TURBO.

### Limited Warranty

TurboChef Technologies, Inc. (“TurboChef”) warrants to you, the purchaser, that under normal use the TurboChef rapid cook oven you have purchased (the “Equipment”) will be free from defects in material and workmanship during the Warranty Period, subject to the terms and conditions set forth herein. The “Warranty Period” is twelve (12) months from the date the Equipment is shipped from TurboChef’s U.S. factory or distribution center. This warranty is conditioned upon you promptly notifying TurboChef of any claims, as provided in the paragraph entitled “Warranty Claims” below, and providing TurboChef with all data and information requested by TurboChef or its service agents in connection with such claims as well as all necessary access to your premises and the Equipment. This warranty is made only to the initial purchaser of the Equipment from TurboChef or its authorized dealer; it is not assignable to subsequent purchasers unless TurboChef consents to such assignment in writing.

### Disclaimer of Warranties

Except as provided in the Limited Warranty above, the Equipment is provided “as-is”. TurboChef disclaims all other warranties, express, statutory or implied, including without limitation, the implied warranties of title, non-infringement, merchantability and fitness for a particular purpose. TurboChef does not warrant that the Equipment will meet your specifications or needs. You acknowledge that you are solely responsible for the selection of the Equipment and determining the suitability of the Equipment for your needs.

### Warranty Exclusions

**Improper Installation, Operation or Maintenance:** Equipment that is not installed, operated and maintained in accordance with TurboChef’s rapid cook oven owner’s manual (as may be updated by TurboChef from time to time, the “Manual”), a copy of which is provided to you with the Equipment or otherwise will be furnished to you upon request, is excluded from this warranty. This warranty does not apply to damage or failure which results, in TurboChef’s or its service agent’s sole opinion, from failure to provide a suitable installation and operating environment (including power and HVAC) and facilities as prescribed by the Manual, misuse, abuse, accident, neglect, power failure or power surges (over or under voltage), or to damage or failure from flood, fire, lightning or other natural or man-made disasters, or other Acts of God, or to Equipment that has missing or altered serial numbers.

**Modifications and Repair:** Equipment that has been modified or altered by persons other than TurboChef or its service agents, or Equipment that has had non-approved devices or connection items attached thereto, is excluded from coverage under this warranty. Repair of the Equipment by anyone other than TurboChef or its authorized service agents will void all warranties on the Equipment.

**Accessories:** Accessories and parts (collectively “Accessories”) that are consumed in the normal course of Equipment operation or maintenance are excluded from this warranty. Failure of or damage to Equipment or components from the use of non-approved cleaning chemicals, devices or processes is also excluded from this warranty. Accessories may include, but are not limited to, ceramic cooking platters, paddles and approved cleaning chemicals and devices.

**Outstanding Invoices:** If the full invoiced amount for Equipment purchased has not been paid within forty-five (45) days from the invoice date, then TurboChef will have no obligation to honor this or any other warranty on the Equipment until payment is received in full, including any accrued interest or other charges, has been satisfied, at which time warranty coverage will be reinstated, but the Warranty Period will not be extended.

### **Warranty Service, Exclusive Remedy**

TurboChef will be solely responsible for determining whether or not the Equipment or any component thereof is defective. Defective components covered by this warranty will be repaired or replaced at TurboChef's option without charge to you and such repaired or replacement components will be covered by this warranty for the balance of the Warranty Period. Parts used in the repair of defective components and replacement components may be new, recovered or rebuilt. At its sole option, TurboChef may decide to replace defective Equipment covered by this warranty with new, recovered or rebuilt Equipment of equal or greater capability, and such Equipment will be covered by this Limited Warranty for the balance of the Warranty Period. Defective Equipment and components will become the property of TurboChef. This paragraph states TurboChef's sole and exclusive obligation and liability and your sole and exclusive remedy under this warranty. TurboChef shall not be responsible for a failure to provide warranty services due to causes beyond TurboChef's or its service agents' control.

### **Warranty Claims**

Claims under this warranty must be reported to TurboChef during our normal working hours at 800.90TURBO, or such other reporting service as TurboChef may designate. Upon receipt of the claim and related information and preliminary verification that the claim is valid, TurboChef will promptly notify an authorized service agent to contact you and arrange for an on-site repair visit during the service agent's normal working hours. Any costs incurred by TurboChef or its service agent associated with a service agent being refused or unable to gain access to the Equipment on your premises, or a claim not covered by this warranty, will be charged to you.

### **Disclaimer of Damages**

TurboChef disclaims all incidental, special and consequential damages, including but not limited to loss of use, lost revenue or profits, or substitute use, suffered by you or any third party, whether arising in contract, tort (including negligence), or otherwise, resulting from any breach by TurboChef or its service agents of this warranty, or resulting from the manufacture, use, or defects, of or in the Equipment, even if TurboChef was apprised of the possibility of such damages.

### **Customer Indemnity**

You agree to indemnify, defend and hold TurboChef harmless from all third party claims, demands, judgments, fees and costs directly or indirectly arising out of or related to your use of the Equipment. You further agree to indemnify and hold TurboChef harmless from any incidental, consequential or special damages suffered by you, including lost revenue or profits, loss of use, or substitute use, during periods of Equipment failure or loss of use.

### **Territory**

This warranty is valid in the United States of America, Canada and Puerto Rico.

### **Governing Law, Entire Warranty**

This warranty shall be governed and construed in accordance with the laws of the State of Texas, USA (except with respect to its provisions regarding conflicts of laws). The warranty described herein is the complete and only warranty for Equipment and supersedes all prior oral or written agreements and understandings that may have existed between us relating to Equipment warranties. The terms of this warranty may not be altered, amended or modified except by a signed writing from TurboChef. Any purported alteration, amendment or modification by a service agent or anyone else will not be enforceable against TurboChef.

### **Charges for Non-Warranty Service or Rejection of Service Visit**

In the event that repairs, replacement or service are provided by TurboChef's service agents for work not covered by this limited warranty, customer agrees to pay the service agent directly according to the service agent's normal scale of charges. In the event TurboChef is invoiced by the service agent for services not covered under this extended warranty, TurboChef will invoice customer and customer will pay such invoice based on terms of net 10 days. Customer also agrees to pay any cost incurred by TurboChef or its service agent associated with a service agent responding to a call for service, but then being refused or unable to gain access to the Oven on Customer's premises. Failure to submit payment may, at TurboChef's discretion, result in TurboChef voiding the balance of the warranty. In no event will TurboChef authorize service to a store with an outstanding Non-Warranty invoice.

# International Limited Warranty

This Limited Warranty shall apply to the sales of all TurboChef Eco ovens (the “Equipment”) manufactured by TurboChef Technologies, Inc. (“TurboChef”), and sold to purchasers outside of the United States, Canada, Puerto Rico, Central and South America by an Authorized Distributor of TurboChef International (the “Authorized Distributor”).

## Limited Warranty

You, the purchaser (“You”) have entered into a sales contract with the Authorized Distributor for the purchase of the Equipment. This Limited Warranty is made to you by the Authorized Distributor from whom you purchased the Equipment with the support of TurboChef. Subject to the limitations stated below, the Authorized Distributor warrants to You that the quantity and specification of the Equipment delivered to You shall be as set out in the Authorized Distributor’s acceptance of your order and that the Equipment will be free from any material defects in the product and workmanship for twelve (12) months from the date of installation (the “Warranty Period”), subject to the terms and conditions set forth herein.

## Disclaimer

You acknowledge that You are solely responsible for the selection of the Equipment and determining the suitability of the Equipment for Your needs. All other warranties, conditions or terms relating to fitness for purpose, quality or condition of the Equipment, whether expressed or implied by statute or common law or otherwise are excluded to the fullest extent permitted by law.

## The TurboChef Global Warranty System

This Limited Warranty commences upon delivery of the Equipment to Your premises. The Authorized Distributor will inspect and install the Equipment at Your premises in accordance with TurboChef’s instructions and will record the serial number of the Equipment, Your contact details, the date and location of installation and the results of the Authorized Distributor’s inspection. This information will be entered by the Authorized Distributor into the TurboChef global warranty system and will be used by TurboChef, the Authorized Distributor and its authorized service agents for the provision of the warranty service.

## Warranty Service

During the Warranty Period, any materially defective Equipment will be repaired or replaced free of charge at TurboChef’s option provided that:

1. You notify the Authorized Distributor from whom You purchased the Equipment and/or TurboChef as soon as reasonably possible after discovery of a defect and in accordance with the warranty claims procedure set out below;
2. You provide the Authorized Distributor from whom You purchased the Equipment and/or TurboChef with all data and information reasonably requested by TurboChef, the Authorized Distributor or its authorized service agents in connection with Your warranty claim;
3. You make the Equipment available to TurboChef, the Authorized Distributor or its authorized service agents;
4. The Equipment has been installed by an Authorized Distributor and you have provided all necessary information for the Authorized Distributor to register the Equipment in the TurboChef global warranty system;
5. The Equipment has been operated and maintained by You in accordance with TurboChef’s “Owner’s Manual” provided with the Equipment (and as updated by TurboChef);
6. You have not used any non-approved devices, accessories, consumables or parts in conjunction with the Equipment; and

7. Repairs, modifications or alterations have not been attempted other than by TurboChef, an Authorized Distributor or its authorized service agent.

Neither TurboChef nor the Authorized Distributor assumes any liability for damage caused by Your failure to provide a suitable installation and operating environment (including power and HVAC) or facilities as prescribed by the Manual, misuse or abuse or by accident, neglect, power failure or power surges (over or under voltage) howsoever arising.

At its sole option, TurboChef may replace defective Equipment or components with new, recovered or rebuilt Equipment of equal or greater capability, and such Equipment or components will be warranted by the Authorized Distributor for the balance of the Warranty Period. Replaced defective Equipment or components will become the property of TurboChef.

**Warranty Claims:** Any warranty claim must be made directly in writing either to the Authorized Distributor from whom You purchased the Equipment or to TurboChef at the following address:

TurboChef Technologies, Inc.  
2801 Trade Center Drive  
Carrollton, Texas 75007  
Phone: +1 214.379.6000  
Fax: +1 214.379.6073

The claim must include the serial number of the Equipment and be received by TurboChef on or before the last day of the Warranty Period. Upon receipt of Your claim, TurboChef will promptly notify an Authorized Distributor or an authorized service agent to contact You, to verify Your claim and, if necessary, to arrange for an on-site repair visit during normal working hours.

**Consumables and Parts Used with The Equipment:** Neither TurboChef nor the Authorized Distributor assumes any liability for consumables and parts that are used in the normal course of Equipment operation or for failure of or damage to Equipment or components from the use of non-approved cleaning chemicals, devices or processes.

**Charges for Service Not Covered by Limited Warranty:** In the event that You request and receive repairs, replacement or service not covered by this Limited Warranty, You will be invoiced and must pay the Authorized Distributor or authorized service agent directly according to its normal scale of charges and business terms.

**Product Liability:** Neither TurboChef nor the Authorized Distributor assumes any liability for any incidental, special or consequential damages, including but not limited to loss of use, lost revenue or profits, or substitute use suffered by You or any third party, whether arising in contract, tort (including negligence), or otherwise resulting from any breach by TurboChef or the Authorized Distributor of the Limited Warranty provided herein.

**Exclusive Remedy:** This Limited Warranty states the Authorized Distributors and TurboChef's sole and exclusive obligation and liability and your sole and exclusive remedy under this Limited Warranty.

**Third Party Rights:** The UK Contract (Rights of Third Parties) Act 1999 is excluded from applying to this Limited Warranty and nothing herein confers or purports to confer on any third party any benefit or any right to enforce any term of this Limited Warranty.

**Severability:** If any item or provision contained in this Limited Warranty or any part of them (“an offending provision”) is declared to be or becomes unenforceable, invalid or illegal for any reason whatsoever in any jurisdiction, the other terms and provisions of this Limited Warranty shall remain in full force and effect in that jurisdiction as if it had been executed without the offending provision appearing in it and the entire Limited Warranty shall remain in full force and effect in all other jurisdictions.

**Governing Law, Entire, Agreement:** This Limited Warranty shall be governed by and construed according to English law. The application of the United Nations Convention on International Sale of Goods to this Limited Warranty is expressly excluded. This Limited Warranty may not be altered, amended or modified by the Authorized Distributor or its service agent, and no representation, alteration, amendment or modification by TurboChef shall be valid unless in a signed form from TurboChef.

This page intentionally blank.

*For service or information:*

WITHIN NORTH AMERICA CALL

Customer Support *at* 800.90TURBO

OUTSIDE NORTH AMERICA CALL

+1 214.379.6000 or Your Authorized Distributor



Part Number: ECO-1001 / Revision B / August 2018  
Country Code: NA/EU

*Global Operations*

2801 Trade Center Drive  
Carrollton, Texas 75007 USA  
+1 214.379.6000 PHONE  
+1 214.379.6073 FAX

*Customer Support*

800.90TURBO  
+1 214.379.6000  
turbochef.com