



VCCG36 Shown

VCCG Series Heavy Duty Gas Griddle

VCCG24
VCCG36
VCCG48
VCCG60
VCCG72

- NOTICE -

This Manual is prepared for the use of trained Vulcan Service Technicians and should not be used by those not properly qualified.

This manual is not intended to be all encompassing. If you have not attended a Vulcan Service School for this product, you should read, in its entirety, the repair procedure you wish to perform to determine if you have the necessary tools, instruments and skills required to perform the procedure. Procedures for which you do not have the necessary tools, instruments and skills should be performed by a trained Vulcan Service Technician.

The reproduction, transfer, sale or other use of this Manual, without the express written consent of Vulcan, is prohibited.

This manual has been provided to you by ITW Food Equipment Group LLC ("ITW FEG") without charge and remains the property of ITW FEG, and by accepting this manual you agree that you will return it to ITW FEG promptly upon its request for such return at any time in the future.

TABLE OF CONTENTS

GENERAL	3
INTRODUCTION	3
MODELS	3
INSTALLATION	3
OPERATION	3
SPECIFICATIONS	3
TOOLS	3
REMOVAL AND REPLACEMENT OF PARTS	5
FRONT PANEL	5
BACK PANEL	5
CONTROL DEFLECTOR (HEAT SHIELD)	5
TEMPERATURE CONTROLLER	6
RADIANT BURNER	6
THERMOCOUPLE (RADIANT BURNER)	7
REMOVAL	7
INSTALLATION	8
PILOT (RADIANT BURNER)	8
IGNITION MODULE	9
GAS VALVE	9
INFRARED BURNER	10
THERMOCOUPLE (INFRARED BURNER)	11
REMOVAL	11
INSTALLATION	11
IGNITOR (INFRARED BURNER)	12
PILOT ORIFICE (INFRARED BURNER)	12
GRIDDLE PLATE ASSEMBLY	13
SERVICE PROCEDURES AND ADJUSTMENTS	14
TEMPERATURE CONTROLLER CALIBRATION	14
RADIANT BURNER - AIR SHUTTER ADJUSTMENT	15
GAS MANIFOLD PRESSURE ADJUSTMENT	15
BURNER GAS ORIFICE CHECK	16
THERMOCOUPLE TEST	17
TEMPERATURE CONTROLLER TEST	17
IGNITION MODULE TEST	18
RADIANT BURNER - PILOT FLAME ADJUSTMENT	19
GAS VALVE TESTS	19
INFRARED BURNER	20
ADJUSTMENT	20
FLAME APPEARANCE	20
ELECTRICAL OPERATION	21
COMPONENT FUNCTION	21
SEQUENCE OF OPERATION	21
GRIDDLE WIRING DIAGRAM	22
TROUBLESHOOTING	23
TEMPERATURE CONTROLLER - LED DIAGNOSTICS AND OPERATING STATUS	23
IGNITION MODULE - LED DIAGNOSTICS AND OPERATING STATUS	23
GENERAL	24
INFRARED BURNER	26
RADIANT BURNER	26

GENERAL

INTRODUCTION

This Service Manual covers specific service information related to the models listed on the front cover. Procedures in this manual will apply to all VCCG Heavy Duty Gas Griddles unless otherwise specified. Raising the griddle plate is not required for servicing the griddle components. Griddle components are serviced through the front and rear. Pictures and illustrations can be of any model unless the picture or illustration needs to be model specific.

The VCCG griddles are available with three different cooking surface types:

- Steel (standard).
- Chrome (optional).
- Rapid Recovery™ Griddle Plate* (optional).

*The Rapid Recovery Griddle plate is a composite material which is engineered to provide a high heat transfer rate to the food. The top surface can be scored or dented by careless use of a spatula or scraper. The center of the plate is an aluminum core with sheets of stainless steel laminated to the top and bottom exterior surfaces.

MODELS

Vulcan

- VCCG24 - 24" x 24" (width x depth) griddle plate.
- VCCG36 - 36" x 24" (width x depth) griddle plate.
- VCCG48 - 48" x 24" (width x depth) griddle plate.
- VCCG60 - 60" x 24" (width x depth) griddle plate.
- VCCG72 - 72" x 24" (width x depth) griddle plate.

INSTALLATION

Generally, installations are made by the dealer or contracted by the dealer or owner. Detailed installation instructions are included in [Installation & Operation Manual](#) that is sent with each unit.

It should be noted that an improperly installed unit, especially an unlevelled unit can lead to premature electrical component failures. A unit that is higher in the front will cause the flue gases to vent improperly and gather in the front near the electrical components.

OPERATION

Detailed operation instructions are included in the [Installation & Operation Manual](#) sent with each unit. The manual is also available online at www.vulcanequipment.com.

SPECIFICATIONS

Electrical

- 120VAC 50/60Hz 2 amp single phase.
- 6 foot corded plug with ground provided.

Gas Manifold Pressure:

- Natural Gas 4.0" W.C.
- Propane Gas 10.0" W.C.

Incoming Gas Pressure:

- 7" to 9" W.C. Natural Gas
- 11" to 12" W.C. Propane Gas.
- Incoming pressure should not exceed 14.0" W.C. (0.5 PSI) for either gas type.

Burner Types

- Griddles with Infrared Burners have one 24,000 BTU/HR burner for each 12" of griddle width.
- Griddles with Radiant Burners* have one 30,000 BTU/HR burner for each 12" of griddle width.

*Atmospheric type "U" shaped aluminized steel.

Controls

- One Solid State thermostat with thermocouple probe for each 12" of griddle width.
- Temperature adjustment range 150°F to 550°F on all griddle plate surface types except the Rapid Recovery Griddle plate (150°F to 450°F).
- One Electronic Ignition module with pilot safety system for each 12" of griddle width.
- One Dual Solenoid gas valve with internal regulator for each 12" of griddle width.

TOOLS

Standard

- Standard set of hand tools.
- VOM with ability to measure micro amp current.

- VOM with minimum of NFPA-70E CAT III 600V, UL/CSA/TUV listed. Sensitivity of at least 20,000 ohms per volt. Meter leads must also be rated at CAT III 600V.
- Temperature tester (K type thermocouple preferred) with surface probe.
- U-Tube or Digital Manometer.
- Thread sealant suitable for use with natural or propane gas.

Special

- Torque wrench capable of measuring at least 25 in-lbs. for tightening thermocouple probe to griddle plate. Bolt size 5/16"-18.
- Safekote 60™ or equivalent Heat Transfer and Anti-Seize Compound rated for 600°F (purchase locally). Apply to thermocouple probe.

REMOVAL AND REPLACEMENT OF PARTS

FRONT PANEL



WARNING Disconnect the electrical power to the machine and follow lockout / tagout procedures.

The front panel holds the temperature controllers, thermostat cycle lights and lighted power switch.

1. Remove four screws securing the front panel to frame.

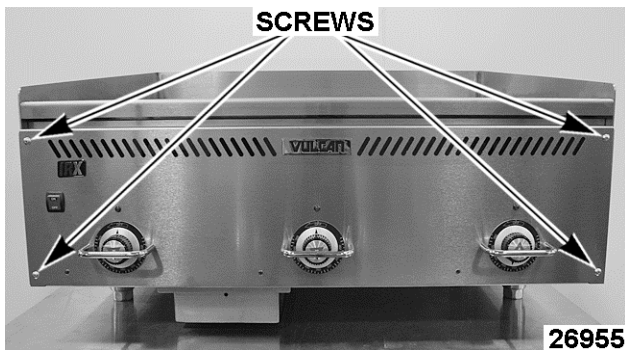

Fig. 1

2. Lay front panel face down in front of the unit while servicing. Pull the drawer out to support the panel as necessary.

NOTE: Griddles that are 60" and 72" wide have 2 grease drawers.

3. Reverse procedure to install.

BACK PANEL



WARNING Disconnect the electrical power to the machine and follow lockout / tagout procedures.

WARNING Shut off the gas before servicing the unit.

WARNING All gas joints disturbed during servicing must be checked for leaks. Check with a soap and water solution (bubbles). Do not use an open flame.

NOTE: Remove the back panel when servicing a burner, temperature probe, pilot burner; or to remove excessive grease build up from the flue area.

1. Disconnect gas supply at griddle.
2. Remove all screws from rear of griddle securing the back panel.

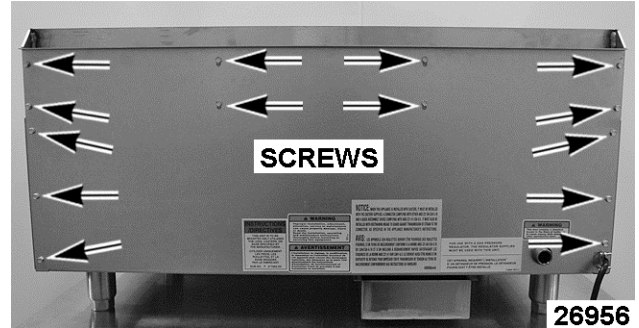

Fig. 2

3. Reverse procedure to install.

CONTROL DEFLECTOR (HEAT SHIELD)



WARNING Disconnect the electrical power to the machine and follow lockout / tagout procedures.

1. Remove FRONT PANEL.
2. Remove control deflector (heat shield) from griddle frame. The number of mounting screws installed depends on griddle width. After screws are removed, lift the control deflector and rotate forward to remove from griddle.

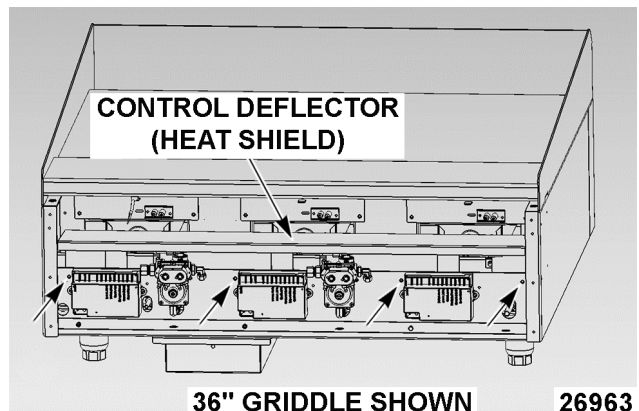

Fig. 3

3. Reverse procedure to install and check for proper operation.

TEMPERATURE CONTROLLER



WARNING Disconnect the electrical power to the machine and follow lockout / tagout procedures.

1. Remove FRONT PANEL.
2. Note wire connections then disconnect them from temperature controller.
3. Loosen screws securing knob guard to front panel to provide clearance for knob removal.

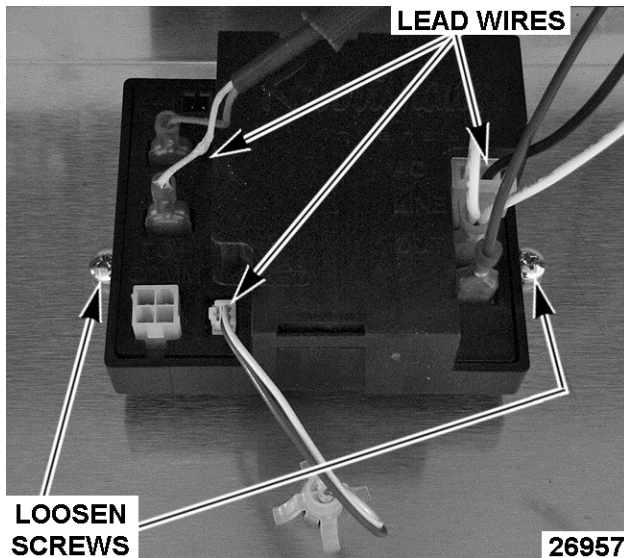

Fig. 4

4. Loosen set screw then remove knob from temperature control shaft.
5. Remove screws securing temperature controller to front panel.

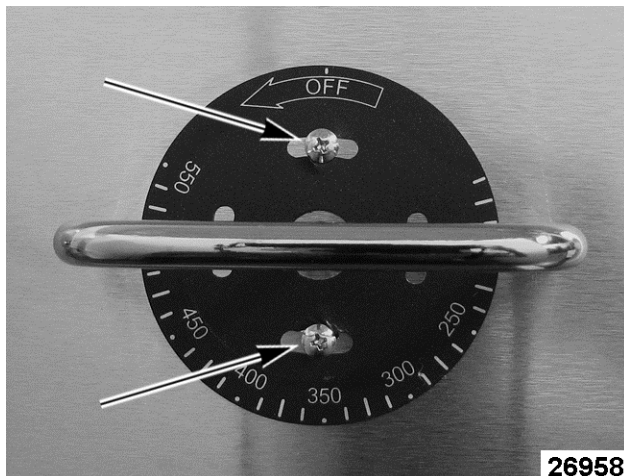

Fig. 5

6. Reverse procedure to install.

7. Check TEMPERATURE CONTROLLER CALIBRATION.

RADIANT BURNER



WARNING Disconnect the electrical power to the machine and follow lockout / tagout procedures.

WARNING Shut off the gas before servicing the unit.

WARNING All gas joints disturbed during servicing must be checked for leaks. Check with a soap and water solution (bubbles). Do not use an open flame.

NOTE: Radiant burner is removed through the front of griddle.

1. Remove BACK PANEL.
2. Remove FRONT PANEL.
3. Remove CONTROL DEFLECTOR (HEAT SHIELD).
4. Remove burner flexible tubing from the burner orifice elbow and gas valve fitting.

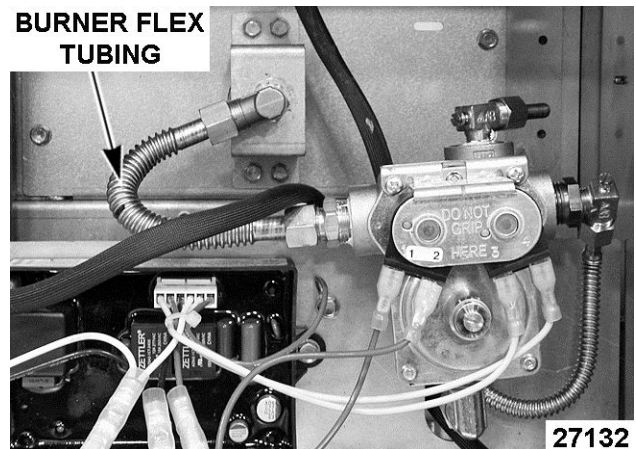

Fig. 6

5. Disconnect compression fitting from gas valve inlet and slide gas valve off the tubing.

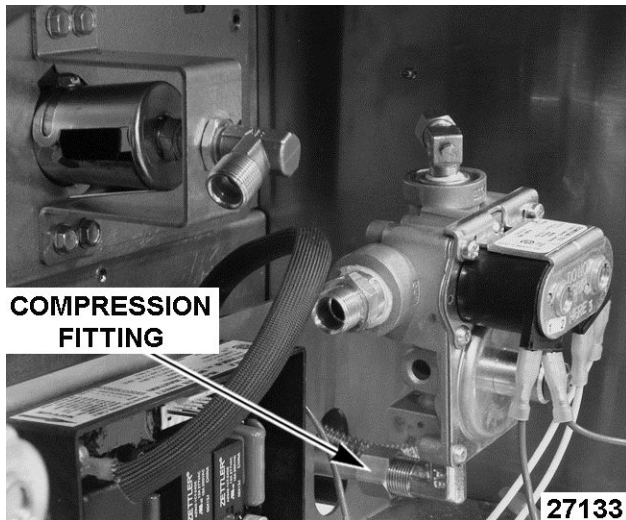

Fig. 7

6. Note thermocouple connections then disconnect from temperature controller.
7. Remove burner shield assembly and burner from griddle (burner remains attached to the burner shield assembly).

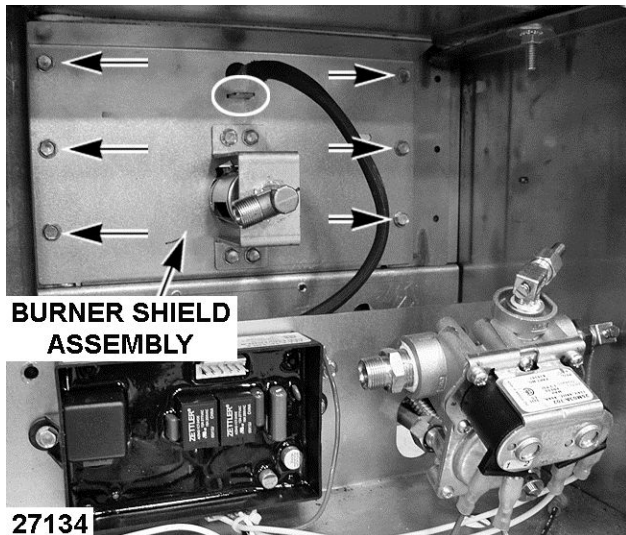

Fig. 8

NOTE: When installing burner, ensure the locating pin and mounting plate at the rear of burner are properly inserted in the mounting slot. At the front of griddle, ensure the thermocouple shield front mounting tab is inserted in the burner shield slot to support the thermocouple shield.

8. Remove orifice holder bracket from burner shield assembly.

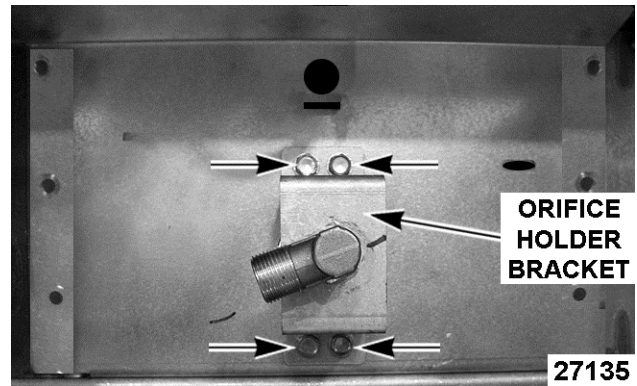

Fig. 9

9. Align mounting screw head on the burner air shutter to the slot in heat shield assembly hole and remove burner from heat shield.
10. Reverse procedure to install and check for proper operation.

THERMOCOUPLE (RADIANT BURNER)



WARNING Disconnect the electrical power to the machine and follow lockout / tagout procedures.

Removal

1. Remove RADIANT BURNER (steps 1 through 8) to access thermocouple shield and thermocouple.
2. Push thermocouple shield toward the front of griddle to disengage the rear mounting tab on thermocouple shield from the support bracket on the bottom of griddle plate.



Fig. 10

3. Loosen mounting nut and remove thermocouple probe from bottom of griddle plate.

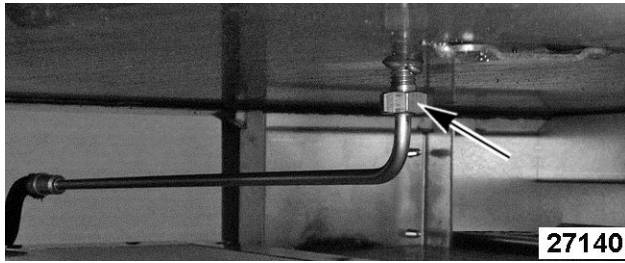

Fig. 11

- Remove insulating sleeve from thermocouple wires and retain for use on replacement thermocouple.

Installation

- Slide insulating sleeve over thermocouple wires.
- Apply a thin coating of heat transfer and anti-seize compound to the thermocouple probe tip and mounting nut threads.
- Route thermocouple probe through the front opening in griddle frame and lay it on top of burner mounting panel.
- From rear of griddle, thread thermocouple probe into the mounting hole in griddle plate and stop when probe tip touches the plate. Torque the mounting nut to a maximum of 25 in-lbs.

NOTICE Do not over tighten or damage to the thermocouple probe may occur. Due to the aluminum plate core, it is also possible to create a raised area over the probe if overtightened.

- Insert rear mounting tab on thermocouple shield into the support bracket on the bottom of griddle plate.
- Route thermocouple wires through the opening in burner shield assembly.
- Re-install RADIANT BURNER.
- Check TEMPERATURE CONTROLLER CALIBRATION.

PILOT (RADIANT BURNER)



WARNING Disconnect the electrical power to the machine and follow lockout / tagout procedures.

WARNING Shut off the gas before servicing the unit.

WARNING All gas joints disturbed during servicing must be checked for leaks. Check with a soap and water solution (bubbles). Do not use an open flame.

- Remove RADIANT BURNER.
- Disconnect compression fitting from pilot.

NOTICE When disconnecting compression fitting for the pilot, support bracket to prevent bending.

- Remove pilot and mounting bracket from the burner mounting panel.
- Pull spark wire through the hole in control mounting panel and remove pilot from griddle.
- Remove pilot from pilot mounting bracket.

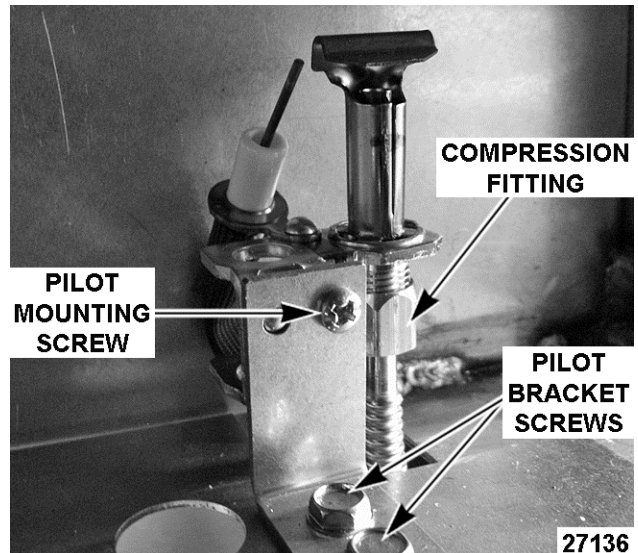

Fig. 12

- Reverse procedure to install.

NOTE: When installing, verify spark gap is 1/8".

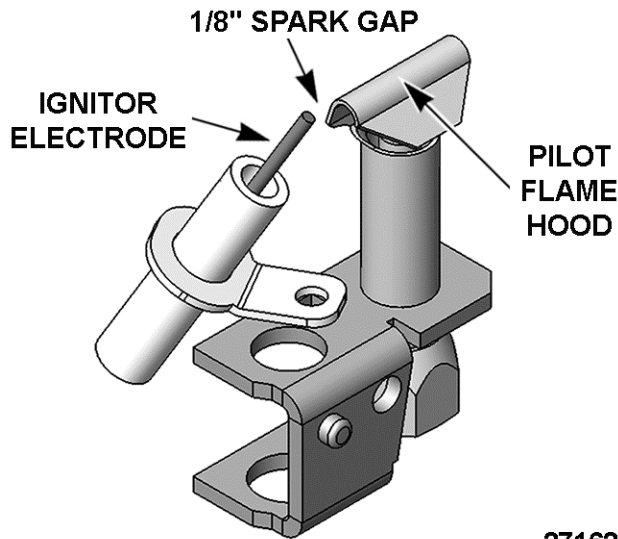

Fig. 13

27162

7. Check for proper operation.

IGNITION MODULE



WARNING Disconnect the electrical power to the machine and follow lockout / tagout procedures.

1. Remove FRONT PANEL.
2. Disconnect ignitor cable and wire harness connector.
3. Remove two screws securing ignition module to the mounting panel.

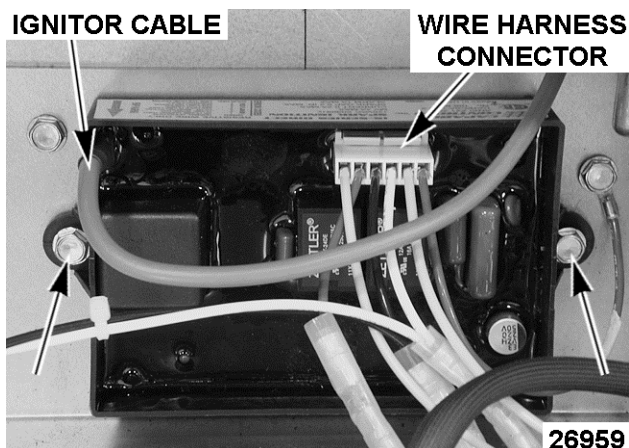

Fig. 14

4. Reverse procedure to install and verify proper operation.

GAS VALVE



WARNING Disconnect the electrical power to the machine and follow lockout / tagout procedures.

WARNING Shut off the gas before servicing the unit.

WARNING All gas joints disturbed during servicing must be checked for leaks. Check with a soap and water solution (bubbles). Do not use an open flame.

NOTE: The gas valve is dual solenoid with internal regulator. One valve supplies gas for the pilot burner and the other valve supplies gas for the main burner.

1. Remove FRONT PANEL.
2. Note lead wire locations and disconnect from gas valve.

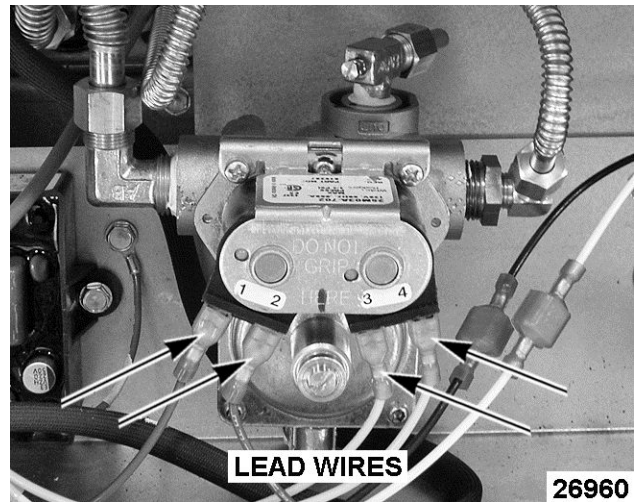

Fig. 15

3. Disconnect compression fitting nuts (3 places) and remove gas valve from griddle.
4. Note position of the four compression fitting elbows and one pipe bushing on gas valve. Remove fittings from valve.

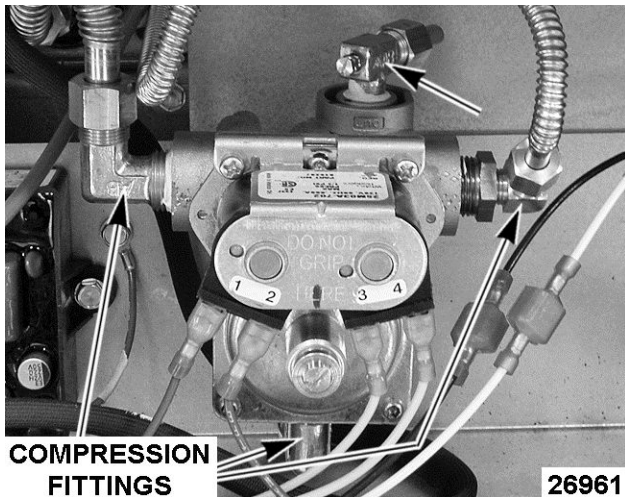

Fig. 16

5. Install compression fitting elbows on replacement gas valve then reverse procedure to install the valve.

⚠ WARNING Clean pipe threads and apply thread sealant that is suitable for use with propane gases.

6. Perform GAS MANIFOLD PRESSURE ADJUSTMENT.

INFRARED BURNER



⚠ WARNING Disconnect the electrical power to the machine and follow lockout / tagout procedures.

⚠ WARNING Shut off the gas before servicing the unit.

NOTE: Infrared burner is removed through the front of griddle.

1. Remove FRONT PANEL.
2. Remove CONTROL DEFLECTOR (HEAT SHIELD).
3. Perform THERMOCOUPLE (INFRARED BURNER) removal procedure to access the thermocouple shield and remove it. The shield must be removed for burner removal clearance but the thermocouple can remain installed.
4. Disconnect compression fitting from pilot orifice fitting at pilot venturi inlet on burner.
5. Disconnect compression fitting from burner orifice fitting at burner venturi inlet.

NOTICE Two wrenches may be required to disconnect compression fittings if the orifice fittings begin to turn or damage to the flexible tubing may occur. Use (1) wrench on compression fitting and (1) wrench on the orifice fitting.

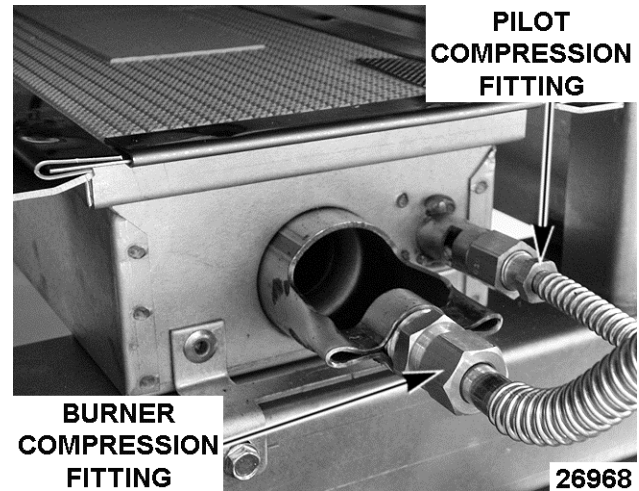

Fig. 17

6. Disconnect the pilot and burner flexible tubing from gas valve.
7. Remove screws (2) securing front of burner to frame.

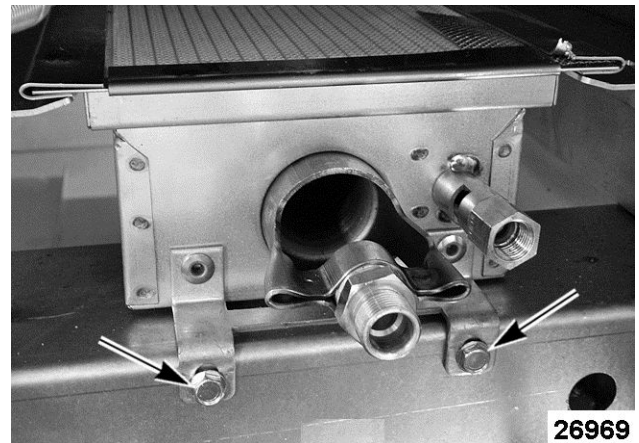

Fig. 18

8. Lift burner up at the front and pull out to remove from griddle.
 - A. Remove pilot orifice fitting and burner orifice fitting from burner. Install on replacement burner.

⚠ WARNING Clean pipe threads and apply thread sealant that is suitable for use with propane gases.

9. Reverse procedure to install replacement burner.
10. Check for proper operation.

THERMOCOUPLE (INFRARED BURNER)



WARNING Disconnect the electrical power to the machine and follow lockout / tagout procedures.

Removal

1. Remove BACK PANEL.
2. Remove FRONT PANEL.
3. Remove CONTROL DEFLECTOR (HEAT SHIELD).
4. Note thermocouple connections then disconnect from temperature controller.
5. Remove burner shield to access the thermocouple shield and thermocouple.

NOTE: The burner shield provides a slotted opening to support the front mounting tab on thermocouple shield.

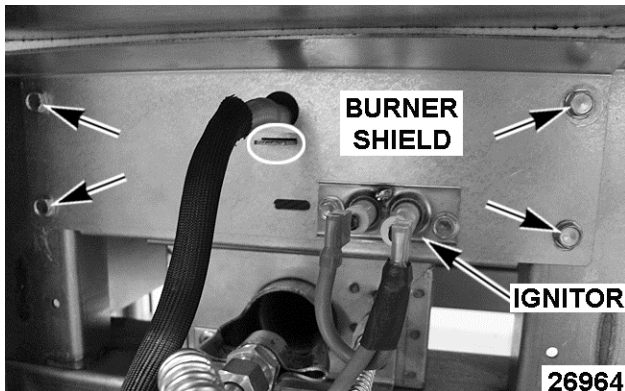

Fig. 19

6. Remove IGNITOR (INFRARED BURNER) from burner shield.
7. Push thermocouple shield toward the front of griddle to disengage the rear mounting tab on thermocouple shield from the support bracket on the bottom of griddle plate.

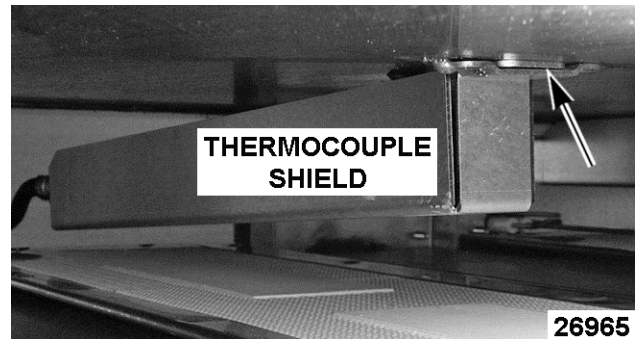

Fig. 20

8. Loosen mounting nut and remove thermocouple probe from bottom of griddle plate.

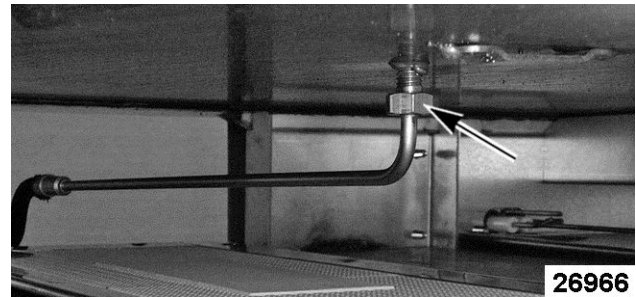

Fig. 21

9. Remove insulating sleeve from thermocouple wires and retain for use on replacement thermocouple.

Installation

1. Slide insulating sleeve over thermocouple wires.
2. Apply a thin coating of heat transfer and anti-seize compound to the thermocouple probe tip and mounting nut threads.
3. Route thermocouple probe through the front opening in griddle frame and lay it on top of burner.
4. From rear of griddle, thread thermocouple probe into the mounting hole in griddle plate and stop when probe tip touches the plate. Torque the mounting nut to a maximum of 25 in-lbs.

NOTICE Do not over tighten or damage to the thermocouple probe may occur. Due to the aluminum plate core, it is also possible to create a raised area over the probe if overtightened.

5. Insert rear mounting tab on thermocouple shield into the support bracket on the bottom of griddle plate.

6. Route thermocouple wires through the opening in burner shield. Lift burner shield and position it so the front mounting tab on the thermocouple shield can be inserted into the upper slotted opening in the burner shield. Secure burner shield to griddle.
7. Install ignitor to burner shield.
8. Connect thermocouple wires to the temperature controller.
9. Install control deflector (heat shield).
10. Install front and back panels.
11. Check TEMPERATURE CONTROLLER CALIBRATION.

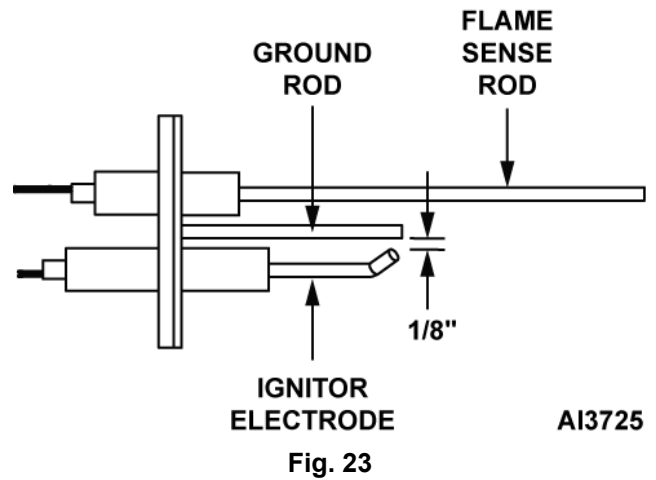

IGNITOR (INFRARED BURNER)



WARNING Disconnect the electrical power to the machine and follow lockout / tagout procedures.

1. Remove FRONT PANEL.
2. Note connection locations then disconnect ignitor cable and jumper from ignitor terminals.
3. Remove screws securing ignitor to burner shield.

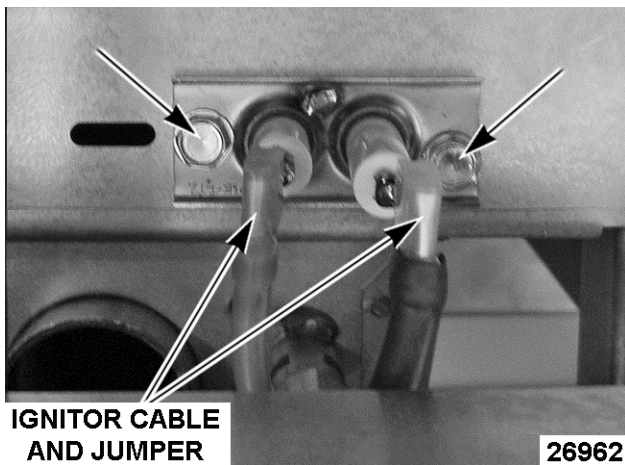

4. Ensure spark gap between ignitor electrode and ground rod is approximately 1/8". If adjustment is necessary, position the ground rod to achieve the correct spark gap.
5. Reverse procedure to install and check for proper operation.

PILOT ORIFICE (INFRARED BURNER)



WARNING Disconnect the electrical power to the machine and follow lockout / tagout procedures.

WARNING Shut off the gas before servicing the unit.

WARNING All gas joints disturbed during servicing must be checked for leaks. Check with a soap and water solution (bubbles). Do not use an open flame.

1. Remove FRONT PANEL.
2. Remove CONTROL DEFLECTOR (HEAT SHIELD).
3. Remove burner shield.

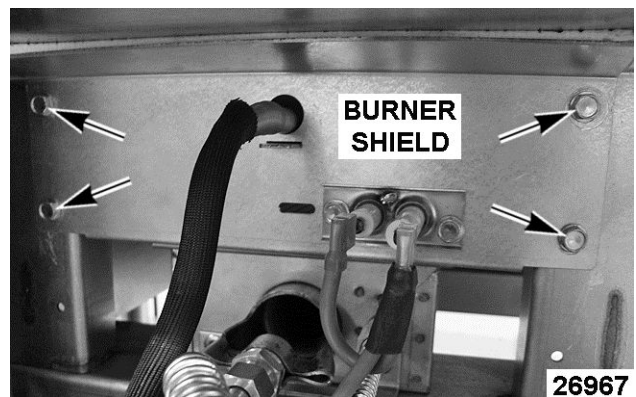

4. Disconnect compression fitting from pilot orifice fitting.

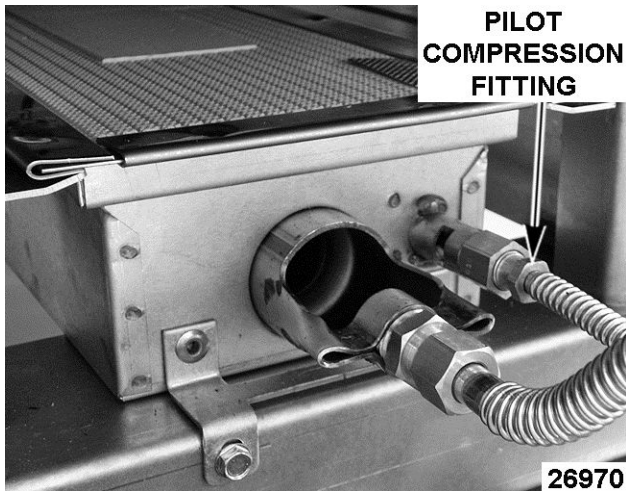

Fig. 25

5. Remove pilot orifice fitting from burner.
6. Tilt pilot orifice fitting to remove the orifice.
7. Reverse procedure to install.

NOTE: When installing, verify orifice size is correct for gas type and is free from debris. Clean the orifice with air or water only.

8. Check for proper operation.

GRIDDLE PLATE ASSEMBLY



WARNING Disconnect the electrical power to the machine and follow lockout / tagout procedures.

WARNING Shut off the gas before servicing the unit.

WARNING All gas joints disturbed during servicing must be checked for leaks. Check with a soap and water solution (bubbles). Do not use an open flame.

NOTICE For larger units, removal and replacement of the griddle plate weld assembly should be done by more than one service technician .

1. Remove FRONT PANEL.
2. Remove BACK PANEL.
3. Remove THERMOCOUPLE (INFRARED BURNER) or THERMOCOUPLE (RADIANT BURNER) from griddle plate. Leave thermocouple wires connected at temperature controller.

4. Remove screws (2) securing griddle plate to frame at the front of griddle.
5. Cut two lengths of 2x4 appropriate for the griddle plate width, leaving additional length to grasp on each side of griddle plate.
6. Lift front of griddle plate and support with 2x4 then lift rear of griddle plate and support with 2x4.



Fig. 26

7. Lift griddle plate and remove from base of equipment.
8. Reverse procedure for installation.

SERVICE PROCEDURES AND ADJUSTMENTS

TEMPERATURE CONTROLLER CALIBRATION

NOTE: Ensure the griddle is level before performing calibration as outlined under LEVELING in the Installation & Operation Manual.

NOTE: Do not use an infrared thermometer for measuring griddle surface temperatures. These devices are highly sensitive to surface color (clean or dirty), angle of reading and distance from the surface. Use a temperature meter with surface probe for all griddle surface temperature measurements.

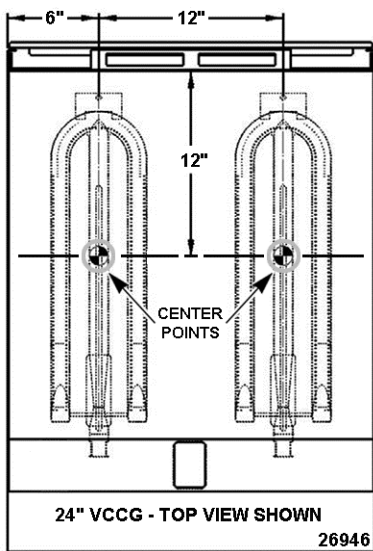

Fig. 27

CALIBRATION CHECK

- Each temperature controller controls a 12" zone of the griddle. Center point area of cooking zones are located 6" from the side splash (left or right), every 12" across the width of griddle, and 12" back from the front of griddle plate.
- Clean the center point areas of cooking zones to ensure good contact with surface probe.
- Set thermostats to 350°F and allow the thermostat cycle light to cycle ON and OFF at least three times to stabilize griddle surface temperatures.
- Monitor the thermostat cycle light for the temperature controller calibration being checked. When the light cycles OFF, record temperature for that zone.
 - If temperature measurement is 350°F ±10°F the control is properly calibrated.

- If temperature measurement is outside of tolerance then temperature control **must** be calibrated.

CALIBRATING TEMPERATURE CONTROL

- Remove FRONT PANEL.
- Loosen screws (2) securing knob guard to the control panel for temperature controller being calibrated.
- Loosen set screw then remove knob from temperature control shaft. Do not rotate the knob during removal.

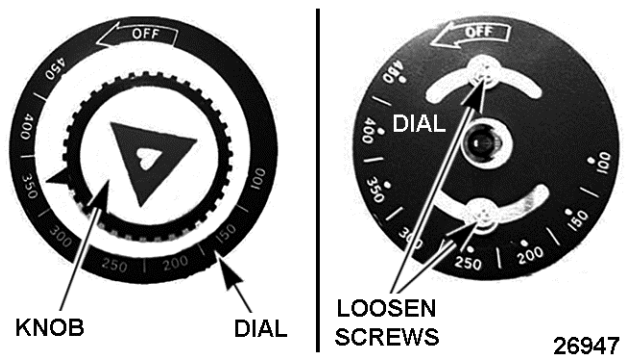

Fig. 28

- Loosen screws on the temperature dial so the dial will rotate.
- Install knob onto the temperature control shaft. Do not rotate the knob during installation.
- Rotate temperature dial to match the temperature reading. Hold dial in position and remove knob. This adjustment offsets the indicated temperature on the dial to the actual temperature measured.
- Tighten dial screws.
- Install knob onto the temperature control shaft and tighten set screw.
- Repeat CALIBRATION CHECK to verify adjustment. Adjust calibration until temperature is within tolerance.

RADIANT BURNER - AIR SHUTTER ADJUSTMENT



WARNING Disconnect the electrical power to the machine and follow lockout / tagout procedures.

WARNING Shut off the gas before servicing the unit.

The efficiency of the burner depends on a delicate balance between the air supply and volume of gas. Whenever this balance is disturbed, poor operating characteristics and excessive gas consumption may occur. An air shutter on the front of the burner controls the gas mixer balance. A yellow streaming flame on the burner is an indication of insufficient primary air. A white-blue flame is a result of excessive primary air. A proper flame should be blue in color, well-defined and seated on the burner port.

SHUTTER SCREW

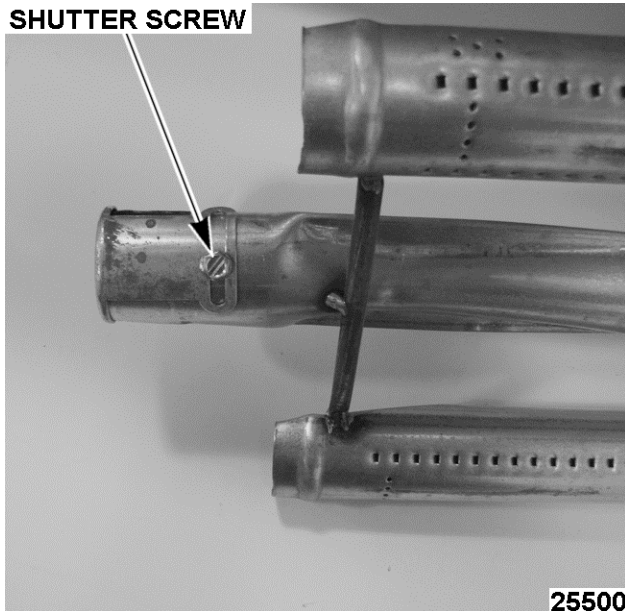

Fig. 29

1. Remove BACK PANEL.
2. Re-connect gas supply to machine then turn the supply on.
3. Connect power to machine.
4. Turn power switch on and rotate temperature controller knob to call for heat.
5. With burner lit, observe flame from back of machine.

- A. If a proper flame is observed as described in the beginning paragraph, no further adjustment is necessary.
- B. If flame is yellow tipping and lifting from burner, continue with procedure to adjust.

6. Disconnect power and turn gas supply off.

7. Remove RADIANT BURNER.

NOTE: The factory default air shutter positions are half open natural; full open propane.

8. Loosen the air shutter screw and hold the shutter in place to prevent movement.

- A. If flame is yellow streaming, slightly rotate shutter to open it. Hold shutter in position and tighten screw to secure the shutter.
- B. If flame is white-blue, slightly rotate shutter to close it. Hold shutter in position and tighten screw to secure the shutter.

9. Install radiant burner.

10. Install back panel.

11. Check for proper operation.

GAS MANIFOLD PRESSURE ADJUSTMENT



WARNING Disconnect the electrical power to the machine and follow lockout / tagout procedures.

WARNING Shut off the gas before servicing the unit.

1. Remove FRONT PANEL.
2. Connect manometer to the pressure check fitting at the top of gas valve being checked.
3. Open the needle valve on the pressure check fitting to allow gas pressure measurement.

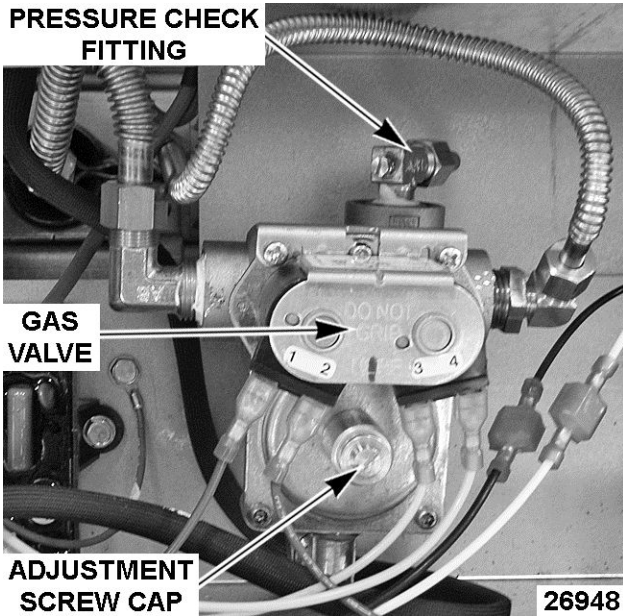

Fig. 30

4. Turn gas supply on.
5. Connect power and turn power switch on.
6. Set all the temperature controls on the griddle to their highest setting and allow burners to light. All burners must be lit during test and adjustment.
7. Check manifold pressure reading and compare to the value in the table below.
 - A. If pressure is within the allowable tolerance, then no adjustment is necessary. Turn off the power switch and gas supply. Return needle valve to the closed position then disconnect manometer.
 - B. If pressure is outside the allowable tolerance, continue with procedure.

GAS TYPE	PRESSURE READINGS (IN W.C.)		
	MANIFOLD	INCOMING LINE	
		RECOMMEND	MAX
Natural	4.0	7.0 to 9.0	14.0
Propane	10.0	11.0 to 12.0	

NOTE: To correctly set the manifold pressure, the incoming line pressure must be within the recommended values for the gas type shown in the table.

8. To adjust, remove adjustment screw cap from the gas valve being checked.
9. Turn the adjusting screw to obtain the proper gas pressure (clockwise = increase; counterclockwise = decrease).

10. Once the correct pressure has been set, turn off the power switch and gas supply. Return needle valve to the closed position then disconnect manometer.
11. Install the adjustment screw cap.
12. Check for proper operation.

BURNER GAS ORIFICE CHECK



WARNING Disconnect the electrical power to the machine and follow lockout / tagout procedures.

WARNING Shut off the gas before servicing the unit.

If burner operation seems poor and other systems have been checked, access the burner for the griddle section being serviced and inspect the burner gas orifice.

- **Radiant Burner** - The gas orifice and elbow fitting is mounted to the orifice holder bracket at the front of the burner venturi inlet.

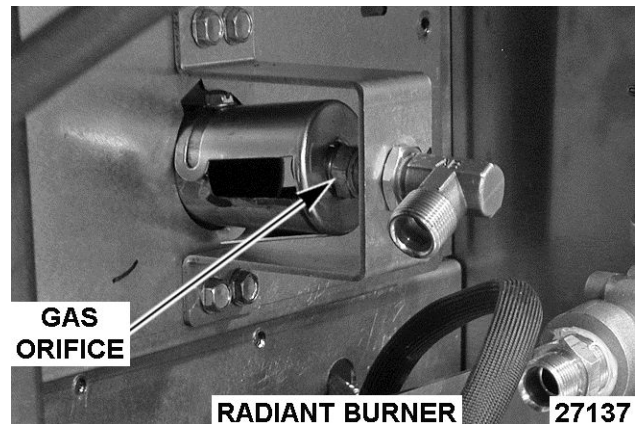

Fig. 31

- **Infrared Burner** - The gas orifice is mounted to the burner at the venturi inlet.

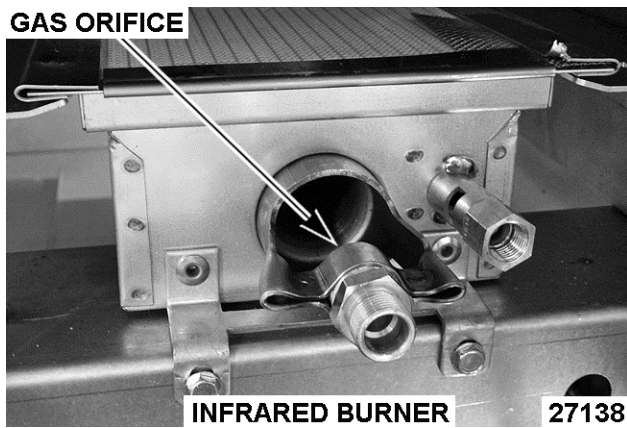
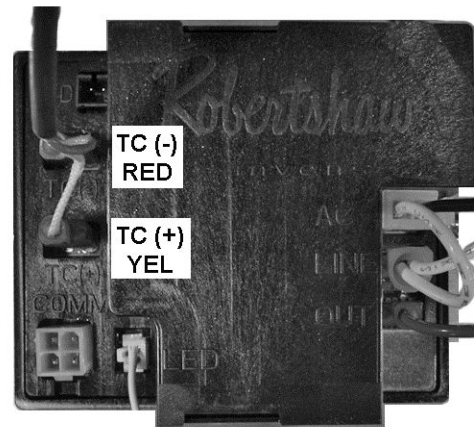

Fig. 32

1. Remove FRONT PANEL.
2. Verify gas orifice is threaded into the fitting properly, and is centered and mounted perpendicular to the burner venturi opening. Adjust alignment as necessary.
3. Check gas orifice for blockage or damage. If dirty, clean with air or water only.
4. Verify gas orifice is correct for the altitude. Contact the appropriate service support department for gas orifice information. Please have the machine model, serial number and gas type ready.

THERMOCOUPLE TEST

1. Cycle the power switch and set temperature knob to call for heat. Observe thermostat cycle light on front panel.
 - A. If blinking, there may be a problem with thermocouple or temperature controller. To identify error code, refer to TEMPERATURE CONTROLLER - LED DIAGNOSTICS AND OPERATING STATUS.
2. Access TEMPERATURE CONTROLLER.
3. Remove thermocouple connections from temperature controller.



26949

Fig. 33

4. Check the thermocouple for resistance.
 - A. If meter reads an overload (OL) condition (open), or zero ohms (short) replace the thermocouple and check temperature controller for proper operation.
5. If resistance is measured, thermocouple is good.

TEMPERATURE CONTROLLER TEST

1. Cycle the power switch and set temperature knob to call for heat. Observe thermostat cycle light on front panel.
 - A. If blinking, there may be a problem with thermocouple or temperature controller. To identify error code, refer to TEMPERATURE CONTROLLER - LED DIAGNOSTICS AND OPERATING STATUS.
 - B. Turn temperature knob to off.
2. Access the TEMPERATURE CONTROLLER.
3. Connect power to the machine.
4. Turn power switch on.
5. Verify temperature controller is receiving 120VAC at pins 1 & 2 on connector, polarity is correct and machine is properly grounded.

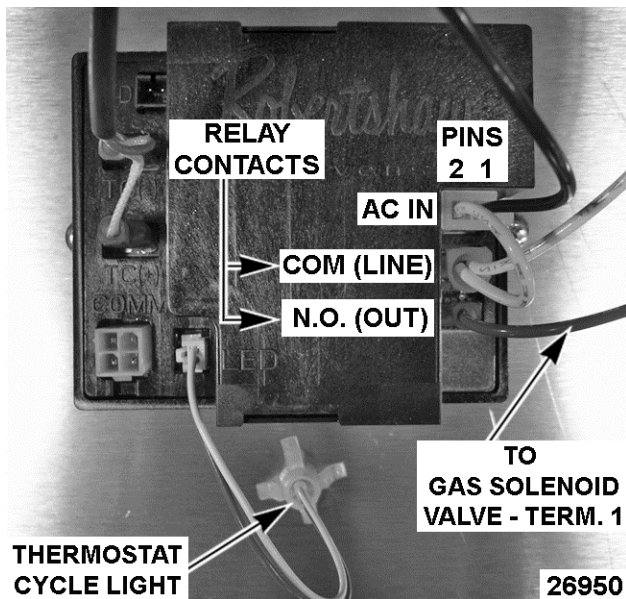

Fig. 34

6. Turn temperature knob to call for heat.
7. Verify thermostat cycle light on the front panel turns on and burner lights.
 - A. If thermostat cycle light and burner come on but turn off within 10 seconds, perform THERMOCOUPLE TEST.

NOTE: Temperature controller will de-energize internal relay if the circuitry detects an open thermocouple and the thermostat cycle light will display a blink code.

- B. If thermostat cycle light and burner do **not** come on, verify internal relay contact operation. Check for 120VAC at terminals 1 & 2 on gas solenoid valve. If voltage is not present, install a replacement temperature controller and perform TEMPERATURE CONTROLLER CALIBRATION.

IGNITION MODULE TEST

NOTE: Ignition module has 10 second ignition trial time, 5 second inter-purge (delay) before retry and will attempt to light pilot 7 times then lockout if unsuccessful.

1. Cycle the power switch and set temperature knob to call for heat.
2. Ignition module is energized and ignition cycle starts. Observe ignition module LED thru front panel sight glass.

- A. If LED is Red and blinking an error code, there may be a problem with pilot burner, flame sense or ignition module. To identify error code, refer to IGNITION MODULE - LED DIAGNOSTICS AND OPERATING STATUS.
- B. LED is Green and blinking during ignition trial and inter-purge. LED then turns to solid Green when pilot flame is established (flame is sensed).

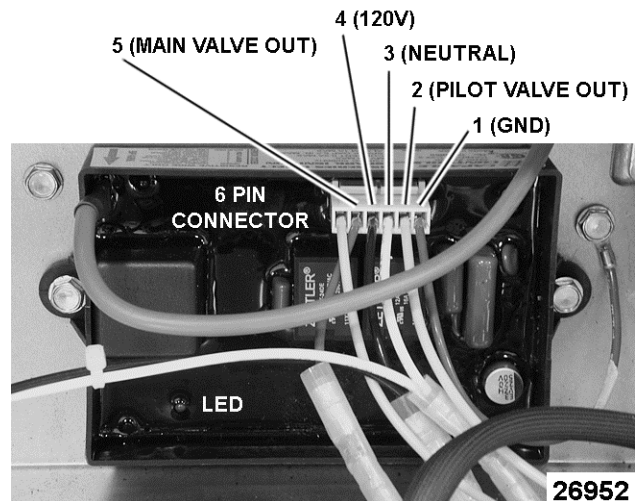

Fig. 35

3. Pilot solenoid valve energized by pilot valve output from ignition module (pin 2) allowing gas flow to the pilot burner. Ignition module generates spark voltage and ignitor begins sparking. If there is no spark then check the following.
 - A. Check for 120VAC at ignition module pin 3 (NEUTRAL) and pin 4 (120V).
 - B. Inspect ignitor cable for damage and continuity.
 - C. Verify spark gap is set at 1/8".
 - D. If component passes the above tests and is not sparking, then replace ignition module.
4. Pilot burner lights and flame is sensed. If electrode continues to spark after pilot is lit then check the following.
 - A. On models with Radiant burner, verify the electrode is fully engulfed by pilot flame.
 - B. Verify ground wire (pin 1) from ignition module is securely grounded to chassis.
5. As long as the ignition module is sensing flame current, then the pilot will stay lit.

6. Main burner valve energized by main valve output (pin 5) from ignition module allowing gas flow to burner and the burner lights.

RADIANT BURNER - PILOT FLAME ADJUSTMENT



⚠ WARNING Disconnect the electrical power to the machine and follow lockout / tagout procedures.

The VCCG series griddle with Radiant burner utilizes a gas valve (dual solenoid) and 90° elbow compression fitting with needle valve adjustment to control gas flow to pilot burner. Each 12" griddle section has individual controls.

1. Turn thermostat knob to the off position.
2. Remove BACK PANEL.
3. Connect power to machine and turn power switch on.
4. Ignitor begins sparking and pilot valve opens to allow gas to pilot.
 - A. If flame envelops 3/8" to 1/2" of the ignitor/ flame sense electrode, pilot burner is adjusted properly.
 - B. If flame is outside of specified range, continue with procedure.
5. Remove FRONT PANEL.
6. Locate the needle valve and adjust.

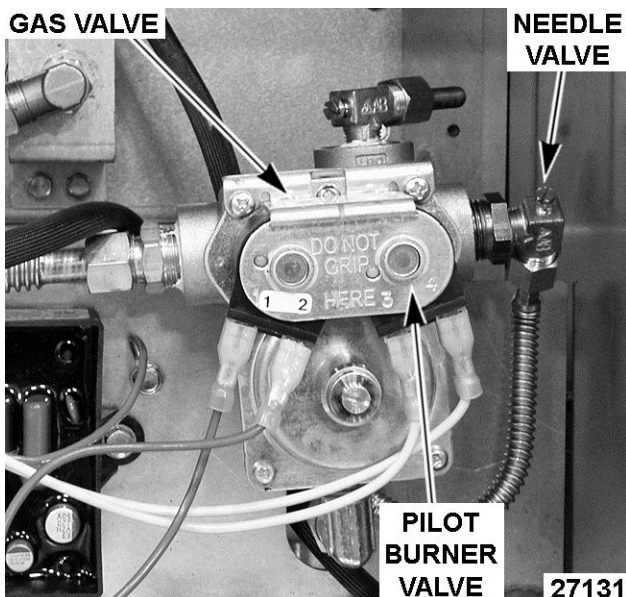

Fig. 36

- A. To increase pilot flame turn valve needle *counterclockwise*. To decrease pilot flame, turn valve needle *clockwise*.

7. Once pilot flame is adjusted correctly, turn thermostat knob to call for heat.
8. Verify pilot burner remains lit when burner lights. Adjust pilot flame as necessary.
9. Disconnect power to machine.
10. Install front and rear panels.
11. Check for proper operation.

GAS VALVE TESTS



⚠ WARNING Disconnect the electrical power to the machine and follow lockout / tagout procedures.

1. Remove FRONT PANEL.
2. Connect power to machine.
3. Turn on power switch and adjust temperature controller to call for heat.

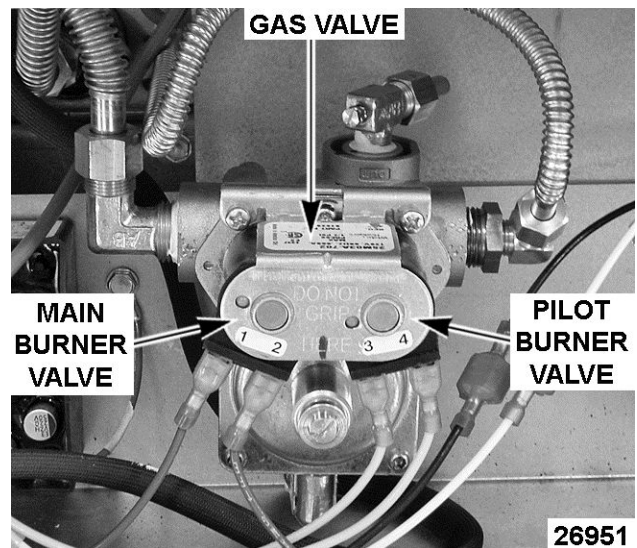

Fig. 37

4. Check for 120VAC to the gas valve (dual solenoid) - Main burner solenoid valve (terminals 1 & 2) and Pilot solenoid valve (terminals 3 & 4).
 - A. If no voltage to either one of the solenoid valves, check wiring connections.
 - B. If pilot solenoid valve has no voltage, perform IGNITION MODULE TEST.

- C. If main burner solenoid valve has no voltage, perform IGNITION MODULE TEST and TEMPERATURE CONTROLLER TEST.
- 5. If 120VAC is present on solenoid valve terminals after performing previous steps, either the solenoid coil or valve is malfunctioning.
- 6. To determine if solenoid coil is malfunctioning, check resistance between main burner solenoid (terminals 1 & 2) and pilot solenoid (terminals 3 & 4). Readings of 100 ohms or less on either solenoid indicate a shorted coil. Install a replacement gas valve and verify GAS MANIFOLD PRESSURE ADJUSTMENT.

INFRARED BURNER

Adjustment

The only adjustment for the Infrared burner is the gas manifold pressure. Verify the pressure is set correctly as outlined under GAS MANIFOLD PRESSURE ADJUSTMENT.

Flame Appearance

Access the infrared burner by removing BACK PANEL. When the Infrared burner first lights you should see a small rolling blue flame, which will clear up after the burner warms. Once warm, a low profile orange flame is the best description of the Infrared burner flame. In some cases, if the burner is operating correctly, you may not be able to see the actual flame. Instead you will see the glow of the ceramic bricks in the burner.

ELECTRICAL OPERATION

COMPONENT FUNCTION

Temperature Controller	Controls griddle surface temperature for the individual heat zone by monitoring thermocouple input (K type).
Temperature Probe ...	Senses griddle surface temperature for the individual heat zone using a K type thermocouple. Provides input to the temperature controller.
Power Switch (SPST switch)	Controls power to all electrical components - gas valve (double regulated), temperature controller and ignition module).
Thermostat Cycle Light	When lit, the light (red LED) indicates temperature controller is calling for heat (internal contacts closed, output is on).
Ignition Module	Controls and monitors gas heating. Generates spark to light gas at the pilot burner, monitors the presence of flame and energizes the main burner solenoid valve upon a call for heat from the temperature control. Module has a 10 second ignition trial time, a 5 second inter-purge (delay) before retry and will attempt to light pilot for 7 times then lockout if unsuccessful.
Ignitor/Flame Sense Electrode	Ignites pilot burner and senses the presence of a flame. Provides flame sense input to the ignition module.
Pilot Burner	When lit, lights the main burner.
Gas Valve	A dual solenoid valve with internal regulator that controls gas flow to the pilot burner and main burner. Pilot solenoid valve is energized by the ignition module after power switch is turned on. Main burner solenoid valve is energized by the temperature controller after the pilot safety circuit is established (pilot lit) and thermostat is calling for heat.

SEQUENCE OF OPERATION

Operation is the same for all griddle models. Each 12" heat zone on the griddle plate has its own temperature controller, thermostat cycle light and ignition system components. Refer to Griddle Wiring Diagram [AI3724](#).

1. Conditions.
 - A. 120VAC connected to griddle and is properly grounded.
 - B. Incoming neutral line - L2 is connected to power switch terminal N (non switching) and to each:
 - 1) Ignition module connector at pin 3 NEUTRAL.
 - 2) Temperature controller at the LINE terminal (internal relay - COM) and jumpered to pin 2 NEUTRAL on temperature controller.
 - C. Incoming hot line - L1 is connected to power switch terminal L1.
 - D. Power switch off (SPST).
 - E. Temperature knobs OFF.
 - F. Griddle temperature below 150°F.
 - G. Gas supply on.
2. Turn power switch ON.
 - A. Power switch internal red light turns on.
 - B. All ignition modules are powered at pin 4 (120V).
 - C. Ignition modules generate spark voltage from the spark/sense terminals to begin sparking at the ignitor/flame sense electrode. LED's blink green during 5 second inter-purge (delay) and 10 second trial for ignition (normal operation).
 - D. Ignition modules turn on the pilot valve output at pin 2 and provide 120V to terminal 3 on the pilot valves. Pilot valve solenoids on the gas valves are energized and gas flows to pilot burners.
 - E. Pilot burners light, flame is sensed and ignitors stop sparking. LED stops blinking and remains solid green.

- F. Ignition modules turn on the main valve output at pin 5.
 - G. L1 present at terminal 2 on the main valve solenoids output and jumpered to LINE IN at pin 1 on temperature controllers. Temperature controllers are powered.
3. Turn temperature knobs to 350°F.
 - A. Thermostat cycle lights (red) turn on. The lights will cycle on/off with the call for heat.
 - B. Temperature controller's internal contacts close (N.O.) and provide L2 (neutral) from the OUT terminal to terminal 1 for main burner solenoids on the gas valves.
 - C. Main burner solenoids on gas valves are energized and gas flows to each burner. Burners light and begin heating griddle.
 4. Griddle will continue to cycle with the temperature controller until the temperature knob is turned off; or the power switch is turned off.

GRIDDLE WIRING DIAGRAM

NOTE: The base model griddle is 24" wide. Each additional 12" griddle section has its own set of identical controls that are connected using a 12" add on wire harness. Because the components and wiring are identical for each section, the diagram below can be used for all models.

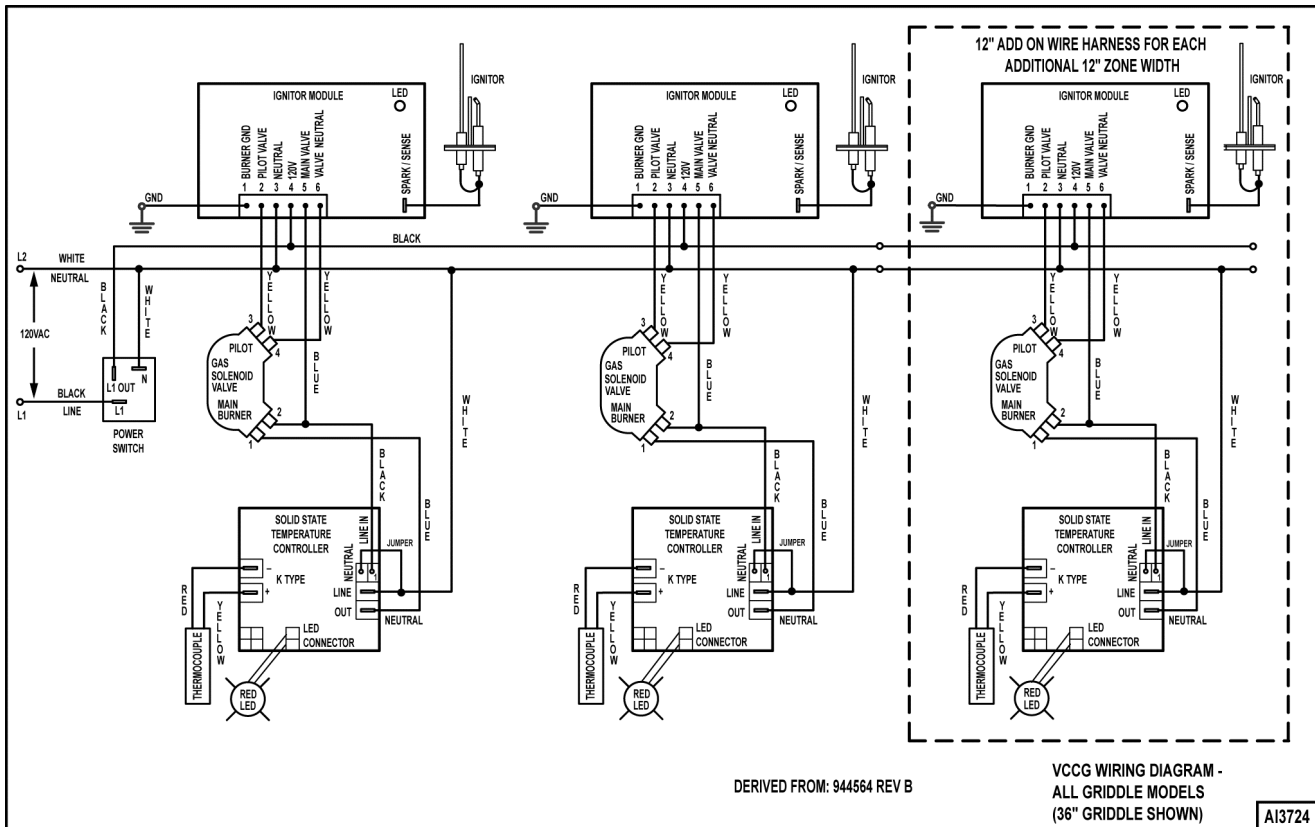

GRIDDLE WIRING DIAGRAM

TROUBLESHOOTING

TEMPERATURE CONTROLLER - LED DIAGNOSTICS AND OPERATING STATUS

NOTE: Each of the individual thermostat LED's are externally mounted to the front panel and are referred to as thermostat cycle lights. Each 12" griddle section has individual controls.

LED Codes

- Solid Red - Indicates temperature controller internal relay is energized "Call For Heat" requested.
- Two quick flashes every 3 seconds indicates a "No Heating" fault condition.
 - LED sequence is - ON for 1 second, OFF for 1 second, ON for 1 second, then OFF for 4 seconds and repeats.
- Three quick flashes every 3 seconds indicates temperature probe input circuit is open.
 - LED sequence is - ON for 1 second, OFF for 1 second, ON for 1 second, OFF for 1 second ON for 1 second, then OFF for 4 seconds and repeat.
- Continuous ON - OFF - ON - OFF - ON cycle indicates an internal problem and the temperature controller must be replaced.

IGNITION MODULE - LED DIAGNOSTICS AND OPERATING STATUS

LED Green for Normal Operation

- Green, ½ sec on, ½ sec off - Inter-purge (delay before ignition re-try if flame is lost)
- Green, blinking rapidly - Trial for ignition
- Green, on solid - Flame detected, pilot/main burner on

LED Red for Error on Operation

Upon detection of a fault by the ignition modules internal diagnostics, sparking is turned off and the output for the pilot valve and main valve are turned off (valves close). Depending on the error, the ignition module then enters lockout mode or standby mode and flashes a red LED error code.

- In lockout mode, all operation is disabled. To clear the error, power must be removed from the module or the temperature controller must be cycled (OFF/ON) to remove the call for heat.
- In standby mode, the control disables operation until the error is corrected, at which time the normal operation sequence is initiated again.

IGNITION MODULE ERROR CODES			
Red Flashes	Error Definition	Error Type	Possible Cause
1 flash, then pause	No pilot flame in trial time	Lockout	<ol style="list-style-type: none"> 1. Verify gas supply is turned on and gas supply pressure is correct. 2. Air not purged from gas supply line. Cycle power switch 2-3 times to see if pilot will light. 3. Gas orifice clogged. 4. Ignitor not sparking - Check wiring connections, condition of ignitor (cracks in ceramic or corrosion build up on flame sense probe) and spark gap.
2 flashes, then pause	Flame sense stuck on	Lockout	<ol style="list-style-type: none"> 1. Ignition module malfunction.
3 flashes, then pause	Pilot valve or Main valve output - relay malfunction	Lockout	<ol style="list-style-type: none"> 1. Ignition module malfunction.
4 flashes, then pause	Repetitive flame loss error	Lockout	<ol style="list-style-type: none"> 1. Verify gas supply is turned on and gas supply pressure is correct. 2. Gas orifice clogged. 3. Pilot flame is not in good contact with flame sense probe. 4. Ignitor malfunction - Check wiring connections, condition of ignitor (cracks in ceramic or corrosion build up on flame sense probe) and spark gap. 5. Heavy drafts in room or vent hood settings.
7 flashes, then pause	Internal control error	Lockout	<ol style="list-style-type: none"> 1. Ignition module malfunction.
On Solid Red	Line voltage or Frequency error	Standby	<ol style="list-style-type: none"> 1. Verify 120VAC supply, polarity is correct and ground is present. 2. Voltage drops or power brown outs during times of heavy usage; or electrical noise created by other equipment running on the same line.

GENERAL

NOTE: Before performing any of the troubleshooting steps listed in this section, check to see if the LED's for the Temperature Controller and the Ignition Module are blinking to indicate a possible problem with the component. The service technician can use the LED blinking codes to assist in determining if these components are functioning properly or in need of replacement.

GENERAL	
PROBLEM	POSSIBLE CAUSES
No spark to ignite pilot burner.	<ol style="list-style-type: none"> 1. Power switch inoperative. 2. No power to ignitor module. 3. Ignition module not properly grounded. 4. Spark gap incorrect. 5. Ignitor/flame sense wire inoperative. 6. Ignition module malfunction.
Spark at ignitor but pilot burner does not light.	<ol style="list-style-type: none"> 1. No power to pilot solenoid valve. 2. Pilot solenoid valve malfunction. 3. Gas supply off or insufficient.
Pilot burner will not stay lit.	<ol style="list-style-type: none"> 1. Spark/flame sense wire connections incorrect. 2. Improper ground on pilot burner. 3. Ignitor/flame sense malfunction. 4. Gas pressure not within specified range; or Incorrect gas type. 5. Pilot flame needs adjusted.
Pilot burner is lit but main burners will not light or maintain flame.	<ol style="list-style-type: none"> 1. Power to temperature controller incorrect. 2. Thermocouple malfunction. 3. Temperature controller malfunction. 4. Gas pressure incorrect or incorrect gas type. 5. Burner orifice obstructed or malfunction. 6. Power to main burner valve incorrect. 7. Main burner valve malfunction.
High/Low heat.	<ol style="list-style-type: none"> 1. Gas pressure incorrect; or incorrect gas type. 2. Burner orifice malfunction or incorrect. See <u>BURNER GAS ORIFICE CHECK</u>. 3. Air shutter not properly adjusted (radiant burner only). 4. Thermocouple malfunction. 5. Temperature controller not properly calibrated.

INFRARED BURNER

INFRARED BURNER	
SYMPTOM	POSSIBLE CAUSE
Burner not lighting properly; or poor burner flame appearance; or burner flame not orange.	<ol style="list-style-type: none"> 1. Orifice incorrect size or dirty. 2. Incorrect gas pressure. 3. Incorrect gas type. 4. Orifice misaligned in venturi. 5. Appliance not venting properly. 6. Burner malfunction.
Burner not lighting properly due to clogged ports.	<ol style="list-style-type: none"> 1. Griddle with Infrared burner is mounted too close to a fryer or charbroiler and the grease laden air is causing burner ports to clog. If burner ports are found to be clogged, install a replacement burner. <p>NOTE: Grease laden air is detrimental to the life of the Infrared burner. If a technician sees a griddle with Infrared burner mounted in a location close to a fryer or charbroiler, please recommend to the customer to move the griddle away from the grease laden air source to prolong the life of the Infrared burner.</p>

RADIANT BURNER

RADIANT BURNER	
SYMPTOM	POSSIBLE CAUSE
Burner flame too yellow.	<ol style="list-style-type: none"> 1. Orifice incorrect size or dirty. 2. Air shutter not adjusted correctly or dirty 3. Incorrect gas pressure. 4. Incorrect gas type. 5. Orifice misaligned in venturi. 6. Appliance not venting properly.
Low burner flame (all burners).	<ol style="list-style-type: none"> 1. Gas valve not adjusted properly or low gas pressure. 2. Incorrect gas type.
Low burner flame (individual burner).	<ol style="list-style-type: none"> 1. Air mixture incorrect.
Burner flame floats on burner.	<ol style="list-style-type: none"> 1. Inadequate air supply. 2. Restricted exhaust flue.