

Mobile Bowl Stand

Stainless Steel

Add Mobility And Flexibility To Bulk Food Preparation

Benefits

- Mobility allows stand to be moved to the worksite or storage
- All-welded stainless steel construction is easy to clean and sanitize

Features

- Top cutout accepts 30-quart (#712) or 80-quart (#713) bowl (not included)
- Lower shelf provides handy storage for supplies and ingredients

Casters

- Heavy-duty 4" stem-mount casters, two with brake



Model 713



Model 712

Specifications:

Shall be Lakeside Model #712 or #713 and shall be of welded stainless steel construction. Top shall be of 16-gauge stainless steel and shall have a cutout to accept a round 30-quart (#712) or 80-quart (#713) bowl (not included). Upright legs shall be of 12-gauge angle stainless steel. Unit shall feature 16-gauge undershelf having floor clearance of 9¾" for storage of utensils, supplies and ingredients. Casters shall be 4" diameter all-swivel with non-marking 1" wide wheels. Two casters shall have locking wheel brake. Unit shall be NSF listed.

Spec. # _____

AIA # _____

Mobile Bowl Stands

Stainless Steel

Spec. #

AIA #

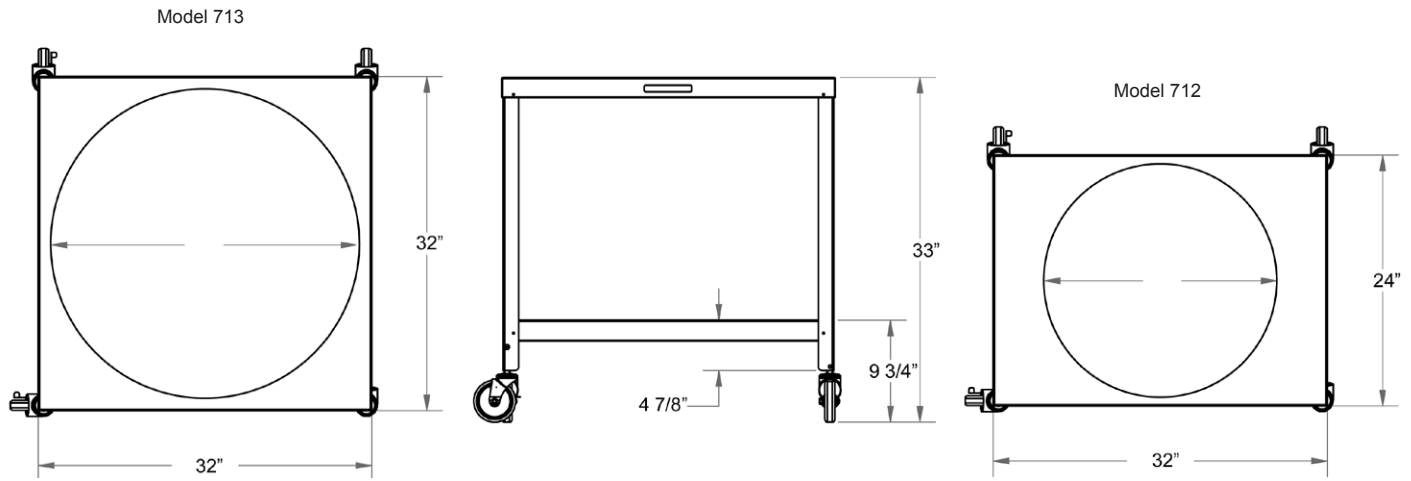

Dimensions:

Model	Overall Size			Accepts Bowl Size	Bowl Cut-out	Casters		Case Wt. Lbs.
	W	L	H			Type	Dia.	
712	24" (610)	32" (813)	33" (838)	30 Quart	29 5/8" (752)	All Swivel 2 w/Brake	4" (102)	50 (22.7 kg)
713	32" (813)	32" (813)	33" (838)	80 Quart	21 1/4" (540)	All Swivel 2 w/Brake	4" (102)	60 (27.3 kg)

Dimensions in () denote metric millimeters, unless otherwise noted.

Options:

- 30-Quart Aluminum Bowl (Model 712)
- 80-Quart Aluminum Bowl (Model 713)



Lakeside Manufacturing, Inc.
4900 West Electric Avenue • West Milwaukee, WI 53219 U.S.A.
800-558-8565 • 414-902-6400 • Fax 414-902-6446 • www.eLakeside.com