

15" Wide WALL CABINETS



Item #: _____ **Qty #:** _____

Model #: _____

Project #: _____



SLIDING DOORS
(Shown with Optional Door Lock)



HINGE DOORS
(Shown with Optional Door Lock)



OPEN

THREE AVAILABLE OPTIONS!

	WCS Series	WCO Series	WCH Series		
L	Sliding Doors Style	Open Style	Hinge Doors Style	Hinge Doors Sizes	Weight
36"	-	WCO-15-36	WCH-15-36	18"	85 lbs.
48"	WCS-15-48	WCO-15-48	WCH-15-48	24"	105 lbs.
60"	WCS-15-60	WCO-15-60	WCH-15-60	30"	125 lbs.

FEATURES:

Wall hung cabinet with intermediate shelf.
Sloping Top enhances sanitary configuration.

CONSTRUCTION:

All TIG welded using the TIG process.
Welded seams finished to match adjacent surfaces.
Unit polished to a satin finish.

MATERIAL:

18 gauge type 430 series stainless steel.
Stainless steel hinges and handles.
Mounting hardware is not supplied.

**OPTIONAL
DOOR LOCK
TA-46**

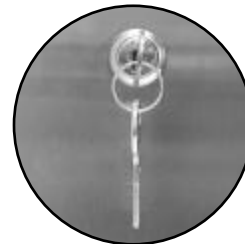

DETAILS and SPECIFICATIONS

TOL ± .500"

ALL DIMENSIONS ARE TYPICAL

WCO-Series Open Style

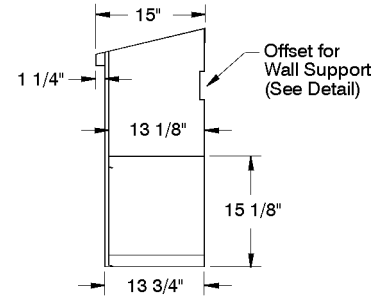
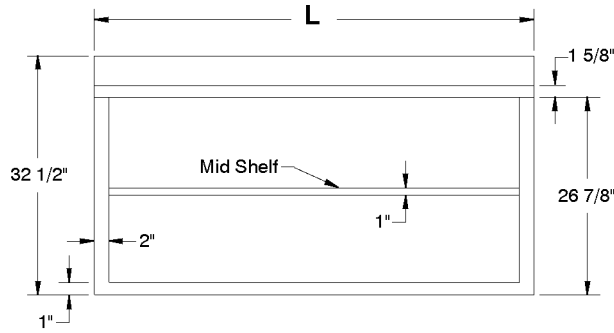

WCS-Series Sliding Door Style

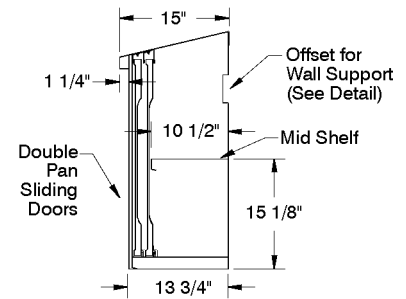
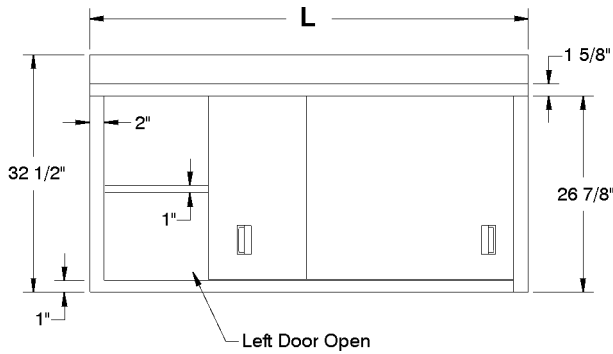

WCH-Series Hinge Door Style

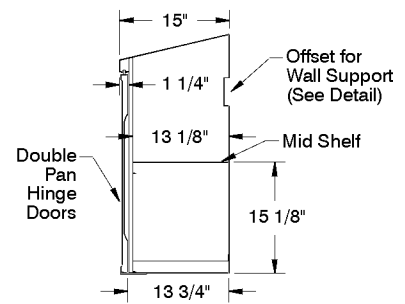
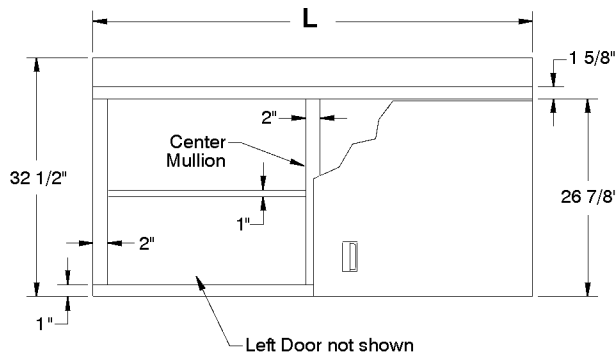

OFFSET DETAIL

