



Rubbermaid

®

Commercial Products

UTILITY REFUSE

DECORATIVE REFUSE

CLEANING

SAFETY

MATERIAL HANDLING

WASHROOM

FOODSERVICE

MEET OUR NEW PRODUCTS



SLIM JIM® RECYCLING STATION PAGE 30

The Slim Jim® Recycling Station offers a front-of-house look with back-of-house functionality. Intuitive lid openings help patrons and staff sort recyclables more effectively. A snap-in connector enables easy and efficient set-up without the use of tools or hardware.



SLIM JIM® UNDER-COUNTER PAGE 33

New Slim Jim® Under-Counter containers are designed with a large, angled opening, providing 2X more access under the counter than traditional slim containers.* This eliminates the need to pull containers out from under the counter, improving user productivity.

*Compared to 23G Vented Slim Jim® containers



THE NEW GENERATION WAVEBRAKE® PAGE 95

With features that surpass traditional mop buckets, the new generation of WaveBrake® helps to clean floors with less effort to get the job done safer, without sacrificing quality and durability. Patented WaveBrake® baffles result in less splashing while mopping and maneuvering, helping to create a safer environment for patrons and staff.



SPILL MOP PAGE 158

The Spill Mop helps clean up spills faster, so the floor dries quicker. Each Spill Mop Pad is made with highly absorbent material designed for quickly removing liquid, water-based spills, and each Biohazard Spill Mop Pad is made with highly absorbent material designed for quickly removing liquid, biohazard spills. Pads turn liquid into gel so that once liquid is fully absorbed, it will not drip.



HEAVY DUTY ADAPTABLE CART PAGE 171

The Heavy Duty Adaptable Cart provides superior versatility for tackling whatever task is at hand. It reduces the need for time-consuming user modifications with a variety of integrated features including: an ergonomic adjustable handle with four positions for maximum comfort, a flip-up shelf, locking casters, and numerous storage features designed to help organize tools and small parts.



FRESHWORKS™ PRODUCE SAVER PAGE 227

The FreshWorks™ Produce Saver regulates the flow of oxygen and ethylene, creating the optimal environment to store fruits and vegetables. By allowing the produce to “breathe”, the FreshWorks™ Produce Saver helps maintain their peak freshness for a longer period of time, reducing the amount of food thrown away due to spoilage.

UTILITY REFUSE AND RECYCLING

| | |
|--|----|
| BRUTE® Utility and Recycling | 12 |
| Rollout Containers | 17 |
| Slim Jim® Containers & Accessories..... | 22 |
| Indoor/Outdoor Utility and Recycling Options | 36 |
| Steel Wastebaskets | 42 |
| Can Liners..... | 43 |
| Accessories | 44 |

DECORATIVE REFUSE

| | |
|---------------------------------|----|
| Indoor/Outdoor Containers | 48 |
| Indoor Containers | 51 |
| Outdoor Containers | 58 |
| Smoking Management..... | 65 |

CLEANING

| | |
|--|-----|
| HYGEN™ Microfiber | 74 |
| Microfiber..... | 87 |
| WaveBrake® Mopping Systems..... | 95 |
| Wet Mop Selection Guide | 98 |
| MAXIMIZER™ Wet Mops..... | 102 |
| Premium Wet Mops | 103 |
| Standard Wet Mops..... | 107 |
| Economy Wet Mops..... | 110 |
| Specialty and Finish Wet Mops | 113 |
| Wet Mop Handles..... | 115 |
| Mopping Accessories..... | 117 |
| Dust Mop Frames and Handles..... | 125 |
| Carpet Bonnets..... | 125 |
| Brooms..... | 126 |
| Brushes..... | 130 |
| Cleaning Brushes..... | 131 |
| Cleaning Tools | 133 |
| Cleaning Carts | 138 |
| Cleaning Cart Accessories..... | 140 |
| Traditional Housekeeping Carts and Accessories | 142 |
| Quick Carts | 145 |
| Mechanical Sweepers | 147 |
| Tools and Accessories | 148 |

SAFETY

| | |
|-------------------|-----|
| Safety Signs..... | 154 |
| Safety Cones..... | 156 |
| Barriers..... | 157 |
| Absorbents | 157 |

MATERIAL HANDLING

| | |
|------------------------------------|-----|
| Bulk Collection..... | 164 |
| Utility Carts..... | 171 |
| Platform Trucks | 179 |
| Caster Selection Guide..... | 182 |
| Accessories | 183 |
| Outdoor Handling and Storage | 185 |
| Storage..... | 187 |

WASHROOM

| | |
|--------------------|-----|
| Skin Care | 191 |
| Air Care | 202 |
| Fixtures..... | 211 |
| Surface Care | 214 |
| Accessories | 216 |

FOODSERVICE

| | |
|--------------------|-----|
| Storage..... | 222 |
| Preparation | 232 |
| Monitoring | 234 |
| Transport | 237 |
| Table Service..... | 241 |
| Youth Service..... | 242 |

COMMON CONVERSIONS

| | |
|--|-----|
| Common Metric-English Conversions..... | 244 |
|--|-----|

STANDARD COLOR GUIDE

| | |
|----------------------------|-----|
| Standard Color Guide | 245 |
|----------------------------|-----|

INDEX







| | |
|-----------------------|-----|
| Product Index | 246 |
| Component Parts | 275 |

CUSTOMER SERVICE 800-347-9800

WWW.RUBBERMAIDCOMMERCIAL.COM

©2019 Rubbermaid Commercial Products LLC
8900 Northpointe Executive Park Drive
Huntersville, NC 28078

CERTIFICATIONS

| | | |
|---|---|---|
|  <p>BS EN ISO 9001/Cleveland, TN 2000 Overhead Bridge Road Cleveland, Tennessee 37312, USA Certificate Number FM 33122</p> <p>Rubbermaid Commercial Products LLC operates a quality management system which complies with the requirements listed above.</p> | <p>ISTA International Safe Transit Association. The Compacted Mops were tested and certified via ISTA Test Procedures.</p> <p>UL Underwriters Laboratory. The UL Classified baskets (FG254000, FG254100, FG254200, FG254300, FG254400) meet the criteria for UL Standard 242 which is a standard of performance for open top, non-metallic wastepaper containers. UL classified baskets are generally found in use in patient care rooms (hospitals/nursing homes).</p> <p>Decorative Waste products that are UL Classified have been tested and approved only to burning paper containment and resistance to temperature rise of surrounding surfaces.</p> <p>Decorative Waste products that are UL Listed/FM Approved/Fire-Safe/Self-Extinguishing have been tested and approved for the fire-safe containment of dry flammable paper waste products.</p>  | <p>FDA Food and Drug Administration does not approve products. The FDA sets regulations which require compliance.</p> <p>NSF Registration Guidelines for Proprietary Substances and Nonfood Compounds:</p> <p>Handwashing and sanitizing products (Category Code E2): Combination of detergents-germicides (single step preparations designed to combine hand washing and sanitizing) will be considered for registration on the basis of their ability to effectively clean the hands as well as their germicidal equivalency to 50 ppm available chlorine. The hands need not be washed with soap or detergent prior to the use of such preparations. However, the hands must be rinsed with potable water after the use of the product and before handling food.</p> <p>Hand sanitizing products (Category Code E3): Products manufactured from those solutions described in CFR Title 21, Section 178.1010, which are applicable for the purpose may be used to sanitize the hands of employees handling food products without a subsequent rinse provided they are germicidally equivalent to 50 ppm available chlorine. Products shall not contain perfumes leaving a residual odor on hands after usage. These sanitizing solutions may be used only after thoroughly washing hands with soap or detergent and water, followed by rinsing with potable water. In many instances, these hand sanitizers may be injected directly into wash/rinse water.</p> |
| <p>ASTM ASTM 404-18 is an American Society for Testing and Materials safety standard for evaluating a High Chair. A "test dummy" that simulates a child of predetermined size is strapped into the chair and various push, pull, and racking tests are conducted on the chair and also using the dummy to simulate forces required to remove dummy, and to determine the safety aspects of ensuring proper confinement within the chair without causing harm to the child.</p> <p>ASTM 2285-04 is an American Society for Testing and Materials safety performance specification that establishes performance requirements, test methods, and labeling requirements to minimize the hazards to children presented by Diaper Changing Tables for commercial use with children up to 50 lbs.</p>  | <p>ADA</p> <ul style="list-style-type: none"> ■ The Americans with Disabilities Act prohibits discrimination and ensures equal opportunity for persons with disabilities in employment, state and local government services, public accommodations, commercial facilities, and transportation ■ Rubbermaid Commercial Products refuse containers need to comply with the ADA regulation; as long as "access openings" for containers are below 48", containers are compliant to ADA regulations ■ All Decorative Waste products comply with ADA Reach Range Requirements, except for step can models; all Decorative Waste wall mount models comply with ADA Reach Range Requirements, dependent upon height placement within the mandated "Reach Range"  <p>ADA COMPLIANT</p> <p>CE The CE marking (an acronym for the French "Conformite Europeenne") certifies that a product has met EU health, safety, and environmental requirements, which ensure consumer safety. Manufacturers in the European Union (EU) and abroad must meet CE marking requirements where applicable in order to market their products in Europe.</p>  | <p>CSFM California State Fire Marshal listing is obtained for various types of containers once tested (by independent testing laboratories) against specific criteria. Following our receipt of UL and/or FM approval for those items, the results were submitted/accepted by California. The State of California is generally regarded to have the most stringent fire codes of all the United States. For an annual fee (every June 30th) the CSFM listings are updated.</p> <p>Decorative Waste products that are UL Listed/FM Approved Fire-Safe/Self-Extinguishing and UL Classified are listed by the California State Fire Marshal pursuant to section 13144.1 of the California Health and Safety Code. See CSFM Listing No. 4480-1025:100.</p> <p>CSFM</p> <p>FM Factory Mutual is an independent testing agency whose approvals are based on Standard 6921 Combustible Waste Containers. Standard 6921 is performance criteria for containers with covers (lids) and their ability to withstand internal fires, maintain a certain range of stability, if dumped, and stay intact over a wide temperature range. Standard 6920 is performance criteria for Oily Waste Containers.</p>  |

GREEN SEAL™

This product meets the Green Seal™ standard for institutional hand cleaners based on its reduced human and aquatic toxicity and reduced smog production potential.



HACCP

Hazard Analysis and Critical Control Points is a systematic method using principles (Food Hygiene Practices) for analyzing a food process and determining the possible chemical, physical, and biological hazards within that process that should prevent any unsafe food from leaving the process (this process could be for a food processing plant or food preparation in a restaurant).

The seven principles are: 1. Application, 2. HACCP Plan Validation, 3. Quality Manual Review, 4. On-site Readiness Review, 5. Registration Audit, 6. Registration, and, 7. Surveillance.

JOINT COMMISSION

The Joint Commission (formerly known as JCAHO) evaluates and accredits nearly 15,000 health care organizations and programs in the U.S. Joint Commission standards address the organization's level of performance in key functional areas, such as patient rights, patient treatment, and infection control.

US GREEN BUILDING COUNCIL

As a member of the United States Green Building Council, we are dedicated to promoting products for buildings that are environmentally responsible and healthy places to work. We offer over 1,000 products that contribute to buildings achieving LEED Certification. Visit www.rubbermaidcommercial.com for more information on USGBC and LEED Certification.



NFPA

Our Steel and Aluminum products comply with the National Fire Protection Association, Life Safety Code #101, section #31, which states wastebaskets and other waste containers shall be noncombustible.



NSF

National Sanitation Foundation is an independent testing lab/organization in Ann Arbor, Michigan. NSF lists products which meet their criteria for cleanability and sanitation: food contact, splash zone and non-food contact, per Standard 2: Food Equipment and Standard 18: Manual Beverage Dispensers. NSF 3-A USDA for equipment used in processing meat and poultry products. Also, Standard 21: Thermoplastic Refuse Containers.



EU

Regulation (EC) No 1935/2004 of the European Parliament and of the council on materials and articles intended to come into contact with food:

The purpose of this European Union Regulation is to ensure that materials and articles intended to come into contact directly or indirectly with food are safe in design and construction to protect the health of consumers.



OBRA

All UL Listed/ FM Approved Fire-Safe/Self-Extinguishing steel receptacles comply with the following Omnibus Budget Reconciliation Act of 1990 Nursing Home Reform Legislation regulations:

- Quality of Life-483.15(h)(1) Environment
- Dietary Service-483.35(h)(3) Disposal of Garbage and Refuse
- Infection Control-483.65(a) Infection Control Program (c) Storage of Linen
- Physical Environment-483.70(a) Life Safety From Fire (g)(2) Smoking Areas

OSHA

- Decorative Waste products comply with Occupational Safety and Health Administration (OSHA) Standard for Occupational Safety and Health Part 1910.141 Sanitation
- Defenders® Step Cans and Medi-Cans™ comply with OSHA Standard for Bloodborne Pathogens, Final Rule 29CFR, Part 1910.1030

LEGEND



Product is packaged for sale in a retail environment



Indicates Executive Series™ Product



Indicates products that contribute to Green Cleaning and Sustainability



UTILITY REFUSE AND RECYCLING

DECORATIVE REFUSE

CLEANING

MATERIAL HANDLING

WASHROOM

FOODSERVICE

ACCESSORIES
& INDEX



FG264360GRAY AND FG262073BLUE

UTILITY REFUSE AND RECYCLING



1956185, 1955959, 1956191

BRUTE® UTILITY AND RECYCLING

| | |
|-----------------------------------|----|
| BRUTE® Utility Containers | 12 |
| BRUTE® Lids and Tops | 13 |
| BRUTE® Dollies | 14 |
| BRUTE® Outdoor Accessories | 14 |
| BRUTE® Cleaning Accessories | 15 |
| BRUTE® Square Containers | 15 |

ROLLOUT CONTAINERS

| | |
|--|----|
| BRUTE® Rollout | 17 |
| BRUTE® Step-On Rollout | 17 |
| BRUTE® Rollout with Casters | 18 |
| BRUTE® Step-On Rollout With Casters | 18 |
| BRUTE® Medical Waste Rollout With Casters | 19 |

SLIM JIM® CONTAINERS

| | |
|---|----|
| Slim Jim® Containers with Venting Channels | 22 |
| Slim Jim® Accessories | 23 |
| Slim Jim® Cleaning Accessories | 24 |
| Slim Jim® Lids | 26 |
| Slim Jim® Recycling Station | 30 |
| Slim Jim® Under-Counter Containers | 33 |
| Resin Slim Jim® Step-On Containers | 35 |

INDOOR/OUTDOOR UTILITY REFUSE AND RECYCLING

| | |
|--|----|
| Resin Step-On Containers | 36 |
| Untouchable® Containers and Tops | 37 |
| Deskside Waste and Recycling Baskets and Tops | 38 |
| Hide-A-Bag | 39 |
| Concept Collection™ | 39 |
| Profile Containers | 40 |
| Fire-Resistant Wastebaskets | 40 |
| Recycling Boxes | 41 |
| Glutton® Recycling Stations | 41 |

STEEL WASTEBASKETS

| | |
|-----------------------------------|----|
| Steel Wastebasket Open Tops | 42 |
| Steel Wastebasket Dome Tops | 42 |

CAN LINERS

| | |
|----------------------------------|----|
| Can Liners | 43 |
| High-Density Coreless Roll | 43 |
| Linear Low-Density | 43 |

ACCESSORIES

| | |
|--|----|
| Utility Refuse Waste Stream Label Kits | 44 |
|--|----|



Resin-based product lines with this symbol contain, at minimum, 20% post-consumer recycled content on select colors and styles.



Metal-based products with this symbol contain, at minimum, 30% post-consumer recycled steel or 70% post-consumer recycled aluminum—which exceeds EPA guidelines.

LOOK FOR THE SPECIALLY MARKED EXECUTIVE SERIES™ PRODUCTS.



UTILITY REFUSE AND RECYCLING

| | | | |
|-----------------------------------|----|---|----|
| BRUTE® CONTAINERS | 12 | SLIM JIM® ACCESSORIES | 23 |
| BRUTE® ACCESSORIES | 13 | UNTOUCHABLE® CONTAINERS AND TOPS | 37 |
| ROLLOUT CONTAINERS | 17 | DESKSIDE CONTAINERS & WASTEBASKETS | 38 |
| SLIM JIM® CONTAINERS | 22 | | |

INCREASE RECYCLING EFFECTIVENESS

IN-FIELD STUDIES YIELDED HIGH DIVERSION RATES

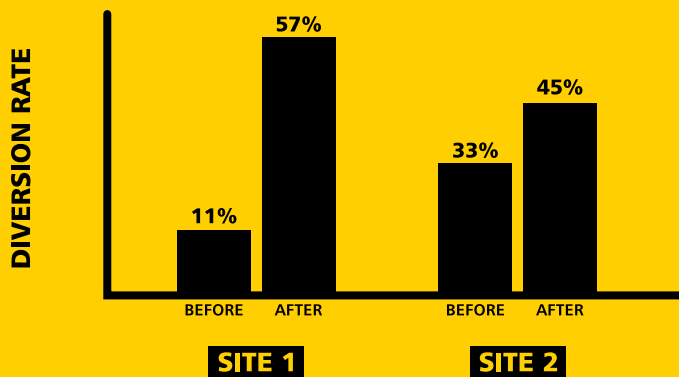

Improving recycling effectiveness has a positive environmental impact, helps facilities achieve sustainability initiatives, and can lead to cost savings. In-field trials that utilized colored containers, labels, lids with stream specific openings proved to increase recycling effectiveness.

In-field Recycling Study—July 2013

BRUTE® UTILITY CONTAINERS



50% EASIER TO LIFT LINERS

THE BRUTE® CONTAINER IS DESIGNED WITH FOUR BUILT-IN VENTING CHANNELS that create airflow throughout the container. This air circulation eliminates the vacuum effect that occurs when lifting out liners in traditional containers. By reducing the pull force required to lift out liners by up to 50%, the BRUTE® container improves productivity and reduces the risk of injury when compared to traditional containers.

UTILITY REFUSE
AND RECYCLING

DECORATIVE REFUSE

CLEANING

MATERIAL HANDLING

WASHROOM

FOODSERVICE

ACCESSORIES
& INDEX



BRUTE

COMMERCIAL-GRADE CONSTRUCTION

Proprietary design constructed with the highest quality material plus a UV inhibitor ensures long life in even the most extreme commercial environments. Guaranteed to never fade, warp, crack, or crush.



RIM WITH RIB-STRENGTHENED DESIGN

Increases strength and resists crushing.

BAG CINCHES

Secure liners allowing for knot-free liner changes. Tested to 20,000 cycles.

ROUNDED HANDLES

Make lifting and moving easier, and are reinforced to resist tearing or damage from even the heaviest loads.

SEAMLESS CONSTRUCTION

Helps make cleaning easier.

VENTING CHANNELS

Make removing liners up to 50% easier, improving productivity and reducing the risk of injury.



CONTOURED BASE HANDLES

Improve grip and ergonomics, reducing strain and improving efficiency when emptying containers.



REINFORCED BASE

Specifically engineered to be dragged over rough surfaces, extending life and durability in even the toughest environments.



UTILITY REFUSE
AND RECYCLING

DECORATIVE REFUSE

CLEANING

MATERIAL HANDLING

WASHROOM

FOODSERVICE

ACCESSORIES
& INDEX



2 & 21 Compliant

BRUTE® Utility Containers

Innovative venting channels make lifting out liners up to 50% easier, improving productivity and reducing the risk of injury.

- Integrated cinches secure the liner, allowing for efficient, knot-free liner changes. Tested to 20,000 cycles
- Proprietary design constructed with the highest quality material plus a UV inhibitor ensures long life in even the most extreme commercial environments. Guaranteed to never fade, warp, crack, or crush
- Rounded handles make lifting and moving easier, and are reinforced to resist tearing or damage from even the heaviest loads
- Reinforced base is specifically engineered to be dragged over rough surfaces, extending life and overall durability even in the toughest environments
- Rim features integrated rib structure to increase strength and resist crushing

EXECUTIVE SERIES™
1867531



Available in a wide range of colors and sizes to complement recycling initiatives and all other collection and sortation needs.



Waste Stream Label Kit

Waste Stream Label Kit Version A* (1977785) and Version C* () contain ten intuitive waste stream decals, ensuring waste sortation accuracy.



Vented BRUTE® Containers

| NO. | COLOR | DESCRIPTION | U.S. DIMENSIONS | U.S. CAPACITY | U.S. SHIP WT/CTN | METRIC DIMENSIONS | METRIC CAPACITY | METRIC SHIP WT/CTN | CAN LINERS | PACK |
|----------|--|--|---------------------|---------------|------------------|-----------------------|-----------------|--------------------|------------|------|
| FG261000 | GRAY, WHT, RED, YEL, DGRN | BRUTE® Container without Lid | 15.6" dia x 17.3" h | 10 gal | 18.5 lb | 39.7 cm dia x 43.0 cm | 37.9 L | 8.4 kg | 5003-88 | 6 |
| 1779699 | BLUE | BRUTE® Container without Lid | 15.6" dia x 17.3" h | 10 gal | 18.5 lb | 39.7 cm dia x 43.0 cm | 37.9 L | 8.4 kg | 5003-88 | 6 |
| 1926827 | BLACK | BRUTE® Container without Lid | 15.6" dia x 17.3" h | 10 gal | 18.5 lb | 39.7 cm dia x 43.0 cm | 37.9 L | 8.4 kg | 5003-88 | 6 |
| FG262000 | GRAY, WHT, BLUE, RED, YEL, DGRN | BRUTE® Container without Lid | 19.5" dia x 22.9" h | 20 gal | 35.0 lb | 49.5 cm dia x 58.1 cm | 75.7 L | 15.9 kg | 5006-88 | 6 |
| 1779734 | BLACK | Executive BRUTE® Container without Lid | 19.5" dia x 22.9" h | 20 gal | 35.0 lb | 49.5 cm dia x 58.1 cm | 75.7 L | 15.9 kg | 5006-88 | 6 |
| FG263200 | GRAY, WHT, BLUE, RED, YEL, DGRN | BRUTE® Container without Lid | 22.0" dia x 27.3" h | 32 gal | 47.0 lb | 55.9 cm dia x 69.2 cm | 121.1 L | 21.3 kg | 5007-88 | 6 |
| 1867531 | BLACK | Executive BRUTE® Container without Lid | 22.0" dia x 27.3" h | 32 gal | 47.0 lb | 55.9 cm dia x 69.2 cm | 121.1 L | 21.3 kg | 5007-88 | 6 |
| FG264360 | GRAY, BLUE, RED, YEL, BLA | BRUTE® Container without Lid | 24.0" dia x 31.5" h | 44 gal | 49.5 lb | 61.0 cm dia x 80.0 cm | 166.6 L | 22.4 kg | 5008-88 | 4 |
| 1779740 | WHITE | BRUTE® Container without Lid | 24.0" dia x 31.5" h | 44 gal | 49.5 lb | 61.0 cm dia x 80.0 cm | 166.6 L | 22.4 kg | 5008-88 | 4 |
| 1779741 | DARK GREEN | BRUTE® Container without Lid | 24.0" dia x 31.5" h | 44 gal | 49.5 lb | 61.0 cm dia x 80.0 cm | 166.6 L | 22.4 kg | 5008-88 | 4 |
| FG265500 | GRAY, WHT, RED, YEL, DGRN | BRUTE® Container without Lid | 26.4" dia x 33.0" h | 55 gal | 52.9 lb | 67.0 cm dia x 83.8 cm | 208.2 L | 24.0 kg | 5011-88 | 3 |
| 1779732 | BLUE | BRUTE® Container without Lid | 26.4" dia x 33.0" h | 55 gal | 52.9 lb | 67.0 cm dia x 83.8 cm | 208.2 L | 24.0 kg | 5011-88 | 3 |
| 1779739 | BLACK | BRUTE® Container without Lid | 26.4" dia x 33.0" h | 55 gal | 52.9 lb | 67.0 cm dia x 83.8 cm | 208.2 L | 24.0 kg | 5011-88 | 3 |

BRUTE® Recycling

| NO. | COLOR | DESCRIPTION | U.S. DIMENSIONS | U.S. CAPACITY | U.S. SHIP WT/CTN | METRIC DIMENSIONS | METRIC CAPACITY | METRIC SHIP WT/CTN | PACK |
|-----------|-------|---|---------------------|---------------|------------------|-----------------------|-----------------|--------------------|------|
| FG262073* | BLUE | BRUTE® Recycling Container without Lid | 19.5" dia x 22.9" h | 20 gal | 35.0 lb | 49.5 cm dia x 58.1 cm | 75.7 L | 15.9 kg | 6 |
| 1926828 | GREEN | BRUTE® Recycling Container without Lid | 19.5" dia x 22.9" h | 20 gal | 35.0 lb | 49.5 cm dia x 58.1 cm | 75.7 L | 15.9 kg | 6 |
| FG263273* | BLUE | BRUTE® Recycling Container without Lid | 22.0" dia x 27.3" h | 32 gal | 47.0 lb | 55.9 cm dia x 69.2 cm | 121.1 L | 21.3 kg | 6 |
| 1788472* | GREEN | BRUTE® Recycling Container without Lid | 22.0" dia x 27.3" h | 32 gal | 47.0 lb | 55.9 cm dia x 69.2 cm | 121.1 L | 21.3 kg | 6 |
| FG264307 | BLUE | BRUTE® Recycling Container without Lid | 24.0" dia x 31.5" h | 44 gal | 49.5 lb | 61.0 cm dia x 80.0 cm | 166.6 L | 22.4 kg | 4 |
| 1926829 | GREEN | BRUTE® Recycling Container without Lid | 24.0" dia x 31.5" h | 44 gal | 49.5 lb | 61.0 cm dia x 80.0 cm | 166.6 L | 22.4 kg | 4 |
| 2044156 | BLUE | BRUTE® Recycling Container without Lid | 26.4" dia x 33.0" h | 55 gal | 52.9 lb | 67.0 cm dia x 83.8 cm | 208.2 L | 24.0 kg | 4 |
| 1977785 | | Waste Stream Label Kit Version A fits 20-Gallon BRUTE® Containers | 7.8" w x 4.7" h | | | | | | 10 |
| 1977787 | | Waste Stream Label Kit Version C fits 32- and 44-Gallon BRUTE® Containers | 9.5" w x 5.7" h | | | | | | 10 |

*NSF Standards 2 and 21 do not apply to recycling containers.

BRUTE® Lids and Tops

Select from a wide range of lids for use in any environment.

SELF-DRAINING LIDS

- Self-draining channels prevent water from pooling, reducing still water buildup
- Snap-lock ensures a secure fit
- Ridges enable stacking of BRUTE® containers to provide a space-efficient storage solution
- Available in 7 colors



DOME TOP LIDS

- Spring action door allows for easy trash disposal while keeping odors in and insects out
- Snap-lock ensures a secure fit

FUNNEL TOP LIDS

- Cut-out top enables hands-free refuse disposal
- Funnel design conceals waste from public view

BRUTE® RECYCLING LIDS*

- Intuitive recycling lids with color-coding options ensure recyclables get into the right bins.



| NO. | COLOR | DESCRIPTION | U.S. DIMENSIONS | U.S. SHIP WT/CTN | METRIC DIMENSIONS | METRIC SHIP WT/CTN | PACK |
|-----------------------|--|---|---------------------|------------------|-----------------------|--------------------|------|
| FG260900 | YEL, WHT, RED, GRAY, DGRN | Lid for 10-Gallon BRUTE® Container | 15.9" dia x 1.2" h | 4.7 lb | 40.4 cm dia x 3.0 cm | 2.1 kg | 6 |
| 1779700 | BLUE | Lid for 10-Gallon BRUTE® Container | 15.9" dia x 1.2" h | 4.7 lb | 40.4 cm dia x 3.0 cm | 2.1 kg | 6 |
| 1926826 | BLACK | Lid for 10-Gallon BRUTE® Container | 15.9" dia x 1.2" h | 4.7 lb | 40.4 cm dia x 3.0 cm | 2.1 kg | 6 |
| FG261960 | YEL, WHT, RED, GRAY, BLA, DGRN | Lid for 20-Gallon BRUTE® Container | 19.8" dia x 1.7" h | 7.1 lb | 50.5 cm dia x 4.3 cm | 3.2 kg | 6 |
| 1779731 | BLUE | Lid for 20-Gallon BRUTE® Container | 19.8" dia x 1.7" h | 7.1 lb | 50.5 cm dia x 4.3 cm | 3.2 kg | 6 |
| FG263100 | YEL, WHT, RED, GRAY, DGRN, BLUE | Lid for 32-Gallon BRUTE® Container | 22.2" dia x 1.6" h | 12.3 lb | 56.5 cm dia x 4.1 cm | 5.6 kg | 6 |
| 1867532 | BLACK | Executive Lid for 32-Gallon BRUTE® Container | 22.2" dia x 1.6" h | 12.3 lb | 56.5 cm dia x 4.1 cm | 5.6 kg | 6 |
| FG264560 | YEL, WHT, RED, GRAY, BLA, DGRN | Lid for 44-Gallon BRUTE® Container | 27.5" dia x 2.0" h | 14.3 lb | 69.8 cm dia x 5.0 cm | 6.5 kg | 4 |
| 1779636 | BLUE | Lid for 44-Gallon BRUTE® Container | 27.5" dia x 2.0" h | 14.3 lb | 69.8 cm dia x 5.0 cm | 6.5 kg | 4 |
| FG265400 | YEL, WHT, RED, GRAY, DGRN | Lid for 55-Gallon BRUTE® Container | 29.1" dia x 3.0" h | 11.6 lb | 68.4 cm dia x 7.4 cm | 5.3 kg | 3 |
| 1779733 | BLUE | Lid for 55-Gallon BRUTE® Container | 29.1" dia x 3.0" h | 11.6 lb | 73.9 cm dia x 7.6 cm | 5.3 kg | 3 |
| 1779738 | BLACK | Executive Lid for 55-Gallon BRUTE® Container | 29.1" dia x 3.0" h | 11.6 lb | 73.9 cm dia x 7.6 cm | 5.3 kg | 3 |
| FG263788 | GRAY, RED | BRUTE® Dome Top for 32-Gallon BRUTE® Container | 22.6" dia x 12.2" h | 9.8 lb | 57.6 cm dia x 31.1 cm | 4.4 kg | 1 |
| 1829398 | BLUE | BRUTE® Dome Top for 32-Gallon BRUTE® Container | 22.6" dia x 12.2" h | 9.8 lb | 57.6 cm dia x 31.1 cm | 4.4 kg | 1 |
| 2044152 | Black | BRUTE® Dome Top for 32-Gallon BRUTE® Container | 22.6" dia x 12.2" h | 9.8 lb | 57.6 cm dia x 31.1 cm | 4.4 kg | 1 |
| FG264788 | GRAY, RED | BRUTE® Dome Top for 44-Gallon BRUTE® Container | 24.8" dia x 12.6" h | 12.1 lb | 63.0 cm dia x 32.1 cm | 5.5 kg | 1 |
| 1834840 | BLUE | BRUTE® Dome Top for 44-Gallon BRUTE® Container | 24.8" dia x 12.3" h | 12.1 lb | 63.0 cm dia x 32.1 cm | 5.5 kg | 1 |
| 2044039 | Black | BRUTE® Dome Top for 44-Gallon BRUTE® Container | 24.8" dia x 12.3" h | 12.1 lb | 63.0 cm dia x 32.1 cm | 5.5 kg | 1 |
| FG265788 | GRAY, RED | BRUTE® Dome Top for 55-Gallon BRUTE® Container | 27.2" dia x 15.5" h | 13.0 lb | 69.2 cm dia x 39.3 cm | 5.9 kg | 1 |
| 2044151 | BLUE | BRUTE® Dome Top for 55-Gallon BRUTE® Container | 27.2" dia x 15.5" h | 13.0 lb | 69.2 cm dia x 39.3 cm | 5.9 kg | 1 |
| 2044040 | BLACK | BRUTE® Dome Top for 55-Gallon BRUTE® Container | 27.2" dia x 15.5" h | 13.0 lb | 69.2 cm dia x 39.3 cm | 5.9 kg | 1 |
| FG354300 ¹ | GRAY | Funnel Top for 32-Gallon BRUTE® Containers | 22.3" dia x 5.0" h | 8.8 lb | 56.8 cm dia x 12.7 cm | 4.0 kg | 4 |
| 2017962 | Red | BRUTE® 32G Lid – Open Top | 24.1" dia x 5.9" h | 14.3 lb | 61.2 cm dim x 15.2 cm | 6.5 kg | 6 |
| 2017963 | Yellow | BRUTE® 32G Lid – Open Top | 24.1" dia x 5.9" h | 14.3 lb | 61.2 cm dim x 15.2 cm | 6.5 kg | 6 |
| 2017964 | Dark Green | BRUTE® 32G Lid – Open Top | 24.1" dia x 5.9" h | 14.3 lb | 61.2 cm dim x 15.2 cm | 6.5 kg | 6 |
| 2017965 | Blue | BRUTE® 32G Lid – Open Top | 24.1" dia x 5.9" h | 14.3 lb | 61.2 cm dim x 15.2 cm | 6.5 kg | 6 |
| 2017738 | Black | BRUTE® 32G Lid – Open Top | 24.1" dia x 5.9" h | 14.3 lb | 61.2 cm dim x 15.2 cm | 6.5 kg | 6 |
| 2017740 | Red | BRUTE® 32G Lid – Bottles/Cans | 24.1" dia x 5.9" h | 14.3 lb | 61.2 cm dim x 15.2 cm | 6.5 kg | 6 |
| 2018161 | Yellow | BRUTE® 32G Lid – Bottles/Cans | 24.1" dia x 5.9" h | 14.3 lb | 61.2 cm dim x 15.2 cm | 6.5 kg | 6 |
| 2018162 | Dark Green | BRUTE® 32G Lid – Bottles/Cans | 24.1" dia x 5.9" h | 14.3 lb | 61.2 cm dim x 15.2 cm | 6.5 kg | 6 |
| 2018163 | Blue | BRUTE® 32G Lid – Bottles/Cans | 24.1" dia x 5.9" h | 14.3 lb | 61.2 cm dim x 15.2 cm | 6.5 kg | 6 |
| 2018166 | Red | BRUTE® 32G Lid – Paper | 24.1" dia x 5.9" h | 14.3 lb | 61.2 cm dim x 15.2 cm | 6.5 kg | 6 |
| 2018167 | Yellow | BRUTE® 32G Lid – Paper | 24.1" dia x 5.9" h | 14.3 lb | 61.2 cm dim x 15.2 cm | 6.5 kg | 6 |
| 2018168 | Dark Green | BRUTE® 32G Lid – Paper | 24.1" dia x 5.9" h | 14.3 lb | 61.2 cm dim x 15.2 cm | 6.5 kg | 6 |
| 2018169 | Blue | BRUTE® 32G Lid – Paper | 24.1" dia x 5.9" h | 14.3 lb | 61.2 cm dim x 15.2 cm | 6.5 kg | 6 |
| 2018212 | Red | BRUTE® 32G Lid – Mixed Recycling | 24.1" dia x 5.9" h | 14.3 lb | 61.2 cm dim x 15.2 cm | 6.5 kg | 6 |
| 2018213 | Yellow | BRUTE® 32G Lid – Mixed Recycling | 24.1" dia x 5.9" h | 14.3 lb | 61.2 cm dim x 15.2 cm | 6.5 kg | 6 |
| 2018214 | Dark Green | BRUTE® 32G Lid – Mixed Recycling | 24.1" dia x 5.9" h | 14.3 lb | 61.2 cm dim x 15.2 cm | 6.5 kg | 6 |
| 2018215 | Blue | BRUTE® 32G Lid – Mixed Recycling | 24.1" dia x 5.9" h | 14.3 lb | 61.2 cm dim x 15.2 cm | 6.5 kg | 6 |
| 1788380 | Blue | BRUTE® 32G Lid – Mixed Recycling | 24.0" dia x 22.5" h | 12.2 lb | 60.9 cm dim x 57.1 cm | 5.5 kg | 6 |
| 1788471 | Green | BRUTE® 32G Lid – Mixed Recycling | 24.0" dia x 22.5" h | 12.2 lb | 60.9 cm dim x 57.1 cm | 5.5 kg | 6 |

¹ Provides hands-free product use.

* NSF Standard 2 and NSF Standard 21 Certification applies to BRUTE® Self-Draining Lids.



BRUTE® Dollies

Provide easy mobility and maneuverability when collecting and transporting heavy loads.



QUIET DOLLY



FG264043

TANDEM DOLLY



FG264600



NONMARKING CASTERS
Nonmarking casters on the Quiet Dolly eliminate 88% of traditional dolly noise across smooth and uneven surfaces.

TWIST LOCK
Secures your BRUTE® container to the BRUTE® Dolly.

STRUCTURAL FOAM
Provides added strength and durability.

| NO. | COLOR | DESCRIPTION | U.S. DIMENSIONS | U.S. CAPACITY | U.S. SHIP WT/CTN | METRIC DIMENSIONS | METRIC CAPACITY | METRIC SHIP WT/CTN | PACK |
|----------|-------|--|----------------------------|-----------------------|------------------|------------------------------|----------------------|--------------------|------|
| FG264000 | BLA | BRUTE® Dolly for 20-, 32-, 44-, and 55-Gallon BRUTE® Containers | 18.2" dia x 6.6" h | 250.0 lb | 11.4 lb | 46.4 cm dia x 16.8 cm | 113.3 kg | 5.2 kg | 2 |
| FG264043 | BLA | BRUTE® Quiet Dolly for 20-, 32-, 44-, and 55-Gallon BRUTE® Containers | 18.2" dia x 6.6" h | 250.0 lb | 10.8 lb | 46.4 cm dia x 16.8 cm | 113.3 kg | 4.9 kg | 2 |
| FG264600 | BLA | BRUTE® Tandem Dolly for 20-, 32-, 44-, and 55-Gallon BRUTE® Containers | 45.0" l x 20.2" w x 8.0" h | 200.0 lb per platform | 19.0 lb | 114.3 cm x 51.4 cm x 20.3 cm | 90.7 kg per platform | 8.6 kg | 1 |
| FG265000 | BLA | Universal Drum Dolly for 55-Gallon BRUTE® Containers | 24.4" dia x 7.1" h | 500.0 lb | 28.2 lb | 61.9 cm dia x 18.1 cm | 226.7 kg | 12.8 kg | 2 |
| FG353000 | BLA | BRUTE® Square Dolly for BRUTE® Square Containers | 17.2" sq x 6.2" h | 300.0 lb | 13.5 lb | 43.8 cm sq x 15.9 cm | 136.07 kg | 6.1 kg | 2 |

BRUTE® Outdoor Accessories

BRUTE® Outdoor Accessories are designed to make BRUTE® containers more productive than ever.

- The BRUTE® Construction and Landscape Dolly is built to easily maneuver over rough terrain for superior handling of heavy loads.
- Built to handle rough and uneven surfaces, the BRUTE® Multi-Surface Dolly is designed to help make moving waste easier than ever.
- The BRUTE® Anchor secures BRUTE® containers to a variety of surfaces for a lifetime of use. The structural foam base fits any 20-, 32-, 44-, and 55-gallon BRUTE® container and is available in Dirt/Sand/Grass and Concrete Kits.



1997801

1997410



1997803



1997802

| NO. | COLOR | DESCRIPTION | U.S. DIMENSIONS | U.S. CAPACITY | U.S. SHIP WT/CTN | METRIC DIMENSIONS | METRIC CAPACITY | METRIC SHIP WT/CTN | PACK |
|---------|-------|---|-----------------------------|---------------|------------------|---------------------------------|-----------------|--------------------|------|
| 1997410 | RED | BRUTE® Construction And Landscape Dolly | 25.2" w x 52.3" h x 31.9" d | 250.0 lb | 28.5 lb | 64.05 cm x 132.94 cm x 81.17 cm | 113.3 kg | 12.9 kg | 1 |
| 1997801 | RED | BRUTE® Multi-Surface Dolly | 22.4" w x 45.6" h x 29.3" d | 250.0 lb | 25.1 lb | 56.94 cm x 116.02 cm x 74.52 cm | 113.3 kg | 11.4 kg | 1 |
| 1997803 | BLACK | BRUTE® Anchor Kit – Concrete | 18.0" dia x 2.8" h | 250.0 lb | 2.9 lb | 45.72 cm x 7.08 cm | 113.3 kg | 1.3 kg | 1 |
| 1997802 | BLACK | BRUTE® Anchor Kit – Dirt/Grass/Sand | 18.0" dia x 2.8" h | 250.0 lb | 4.5 lb | 45.72 cm x 7.08 cm | 113.3 kg | 2.0 kg | 1 |

BRUTE® Rim Caddy

Turn your BRUTE® container into a cleaning cart with storage and transport for spray bottles, wet-floor signs, lobby dust pan, brushes, liners, gloves, and other cleaning supplies.

- Snaps securely onto the rim of BRUTE® 44-Gallon Containers
- Integrated bag straps allow for easy can liner attachment and removal of can liners.
- User-friendly handle improves maneuverability and minimizes contact with waste
- Durable construction with smooth surfaces for easy cleaning



FG9W8700



FG264900



Holds spray bottles, safety signs, and many other cleaning supplies.

Integrated can liner straps allow easy attachment and removal of can liners.

Snap-on tabs keep caddy and accessories in place, even when removing a full liner.

Efficiently dispense smaller liners from inside the BRUTE® container.

FG9W8700 Rim Caddy shown on FG264360 BRUTE® 44-Gallon Utility Container with Venting Channels, with FG264043 Quiet Dolly and other accessories sold separately.

| NO. | COLOR | DESCRIPTION | U.S. DIMENSIONS | U.S. SHIP WT/CTN | METRIC DIMENSIONS | METRIC SHIP WT/CTN | PACK |
|----------|-------|---|-----------------------------|------------------|-----------------------------|--------------------|------|
| FG9W8700 | YEL | BRUTE® Rim Caddy for 44-Gallon Containers | 32.5" l x 26.5" w x 6.75" h | 4.9 lb | 82.6 cm x 67.3 cm x 17.1 cm | 2.2 kg | 1 |
| FG264900 | GRAY | Maid Caddy | 16.0" l x 9.0" w x 5.0" h | 6.5 lb | 40.6 cm x 22.9 cm x 12.7 cm | 2.9 kg | 4 |

BRUTE® Caddy Bag

Knock out quick cleanups on the go with onboard storage and transport for spray bottles, brushes, liners, gloves, and other supplies.

- Numerous pockets for all your cleaning supplies
- Durable vinyl material for easy cleaning



1867533



FG264200

| NO. | COLOR | DESCRIPTION | U.S. DIMENSIONS | U.S. SHIP WT/CTN | METRIC DIMENSIONS | METRIC SHIP WT/CTN | PACK |
|----------|-------|--|---------------------|------------------|-----------------------|--------------------|------|
| FG264200 | YEL | BRUTE® Caddy Bag for 32- and 44-Gallon BRUTE® Containers | 20.0" dia x 20.5" h | 10.7 lb | 50.8 cm dia x 52.1 cm | 4.8 kg | 6 |
| 1867533 | BLACK | Executive BRUTE® Caddy Bag for 32- and 44-Gallon BRUTE® Containers | 20.0" dia x 20.5" h | 10.7 lb | 50.8 cm dia x 52.1 cm | 4.8 kg | 6 |

BRUTE® Square Containers

Increased capacity for storage or refuse collection.

- Square shape offers up to 14% more capacity than round containers
- Tight-fitting indented lid design helps protect dry goods and other contents, while facilitating stacking during transportation and storage
- Nesting handles allow secure fit in side-by-side use
- Gray and white are USDA Meat and Poultry Equipment Group listed and assist in complying with HACCP guidelines
- Certified to NSF Std. #2 (Red, Gray, and White) and Std. #21 (Gray and White)



FG352600



FG352900

Containers and Lids

*Not for sale in California. NSF Standard 2 Certification applies to containers and lids.

| NO. | COLOR | DESCRIPTION | U.S. DIMENSIONS | U.S. CAPACITY | U.S. SHIP WT/CTN | METRIC DIMENSIONS | METRIC CAPACITY | METRIC SHIP WT/CTN | CAN LINERS | PACK |
|----------|----------------|---------------------------------------|-------------------|---------------|------------------|-------------------|-----------------|--------------------|----------------|------|
| FG352600 | WHT, RED, GRAY | BRUTE® Square Container without Lid | 25.1" w x 22.5" h | 28 gal | 54.0 lb | 63.8 cm x 57.2 cm | 106 L | 24.5 kg | 5016-88* | 6 |
| FG353600 | WHT, GRAY | BRUTE® Square Container without Lid | 27.0" w x 28.8" h | 40 gal | 51.2 lb | 68.6 cm x 73 cm | 151.4 L | 23.2 kg | 5079, 5013-88* | 4 |
| FG352700 | WHT, GRAY | Lid for FG352600 Container | 24.3" w x 2.0" h | | 16.8 lb | 61.6 cm x 5.1 cm | | 7.6 kg | | 6 |
| FG353900 | WHT, GRAY | Lid for FG353600 Container | 26.0" sq x 2.0" h | | 15.3 lb | 66.0 cm x 5.1 cm | | 6.9 kg | | 4 |
| FG352900 | RED | Snap-Lock® Lid for FG352600 Container | 21.9" x 2.1" h | | 16.8 lb | 55.6 cm x 5.4 cm | | 7.6 kg | | 6 |



UTILITY REFUSE
AND RECYCLING

DECORATIVE REFUSE

CLEANING

MATERIAL HANDLING

WASHROOM

FOODSERVICE

ACCESSORIES
& INDEX

ROLLOUT CONTAINERS



HANDS-FREE LID OPERATION

DESIGNED TO HELP PROMOTE PRODUCTIVITY With just a step, the pedal lifts the lid, eliminating the need to keep one hand free to hold the lid open.

Rollout Containers

Easy mobility for material handling, general refuse, and bulk waste collection.

- Available in 32-Gallon, 50-Gallon, 65-Gallon, and 95-Gallon capacities for improved productivity
- Heavy-duty wheels with high-performance treads are optimized for use indoors and outdoors
- Reinforced rim for superior structural integrity and robust lid designed for added strength
- Rollout lids open fully and stay in place to prevent swinging during transport
- Compliant with ANSI Standard Z245.60 (Types B and G) for compatibility with auto-lifters
- Smooth contours and seamless construction make cleaning easier and quicker, to improve staff productivity
- Designed with an ergonomic handle for comfortable push or pull operation
- High-quality materials plus a UV inhibitor extend the life of the container



1971941



FG9W2173

BRUTE® Standard Rollouts

| NO. | COLOR | DESCRIPTION | U.S. DIMENSIONS | U.S. CAPACITY | U.S. SHIP WT/CTN | METRIC DIMENSIONS | METRIC CAPACITY | METRIC SHIP WT/CTN | PACK |
|----------|------------|-----------------------------------|-----------------------------|---------------|------------------|------------------------------|-----------------|--------------------|------|
| 1971941 | GRAY | BRUTE® Rollout | 28.6" l x 20.6" w x 37.1" h | 32 gal | 34.0 lb | 72.5 cm x 52.4 cm x 94.4 cm | 120 L | 15.4 kg | 2 |
| 1971943 | BLUE | BRUTE® Rollout | 28.6" l x 20.6" w x 37.1" h | 32 gal | 34.0 lb | 72.5 cm x 52.4 cm x 94.4 cm | 120 L | 15.4 kg | 2 |
| FG9W2700 | YEL | BRUTE® Rollout Container with Lid | 28.5" l x 23.4" w x 36.5" h | 50 gal | 39.0 lb | 72.4 cm x 59.4 cm x 92.7 cm | 189.3 L | 17.7 kg | 2 |
| FG9W2700 | GRAY, BLUE | BRUTE® Rollout Container with Lid | 30.1" l x 24.0" w x 39.6" h | 50 gal | 50.0 lb | 76.4 cm x 60.9 cm x 100.5 cm | 189.3 L | 22.7 kg | 2 |
| 1829410 | WHITE | BRUTE® Rollout Container with Lid | 28.5" l x 23.4" w x 36.5" h | 50 gal | 39.0 lb | 72.4 cm x 59.4 cm x 92.7 cm | 189.3 L | 17.7 kg | 2 |
| 1829411 | GREEN | BRUTE® Rollout Container with Lid | 28.5" l x 23.4" w x 36.5" h | 50 gal | 39.0 lb | 72.4 cm x 59.4 cm x 92.7 cm | 189.3 L | 17.7 kg | 2 |
| FG9W2100 | GRAY | BRUTE® Rollout Container with Lid | 32.3" l x 25.3" w x 44.7" h | 65 gal | 33.5 lb | 82.0 cm x 64.3 cm x 113.5 cm | 246.05 L | 15.2 kg | 1 |
| FG9W2173 | BLUE | BRUTE® Rollout Container with Lid | 32.3" l x 25.3" w x 44.7" h | 65 gal | 33.5 lb | 82.0 cm x 64.2 cm x 113.5 cm | 246.05 L | 15.2 kg | 1 |
| FG9W2200 | GRAY | BRUTE® Rollout Container with Lid | 37.2" l x 28.6" w x 46.0" h | 95 gal | 38.5 lb | 94.3 cm x 72.6 cm x 116.8 cm | 359.6 L | 17.5 kg | 1 |
| FG9W2273 | BLUE | BRUTE® Rollout Container with Lid | 37.2" l x 28.6" w x 46.0" h | 95 gal | 38.5 lb | 94.3 cm x 72.6 cm x 116.8 cm | 359.6 L | 17.5 kg | 1 |

BRUTE® Step-On Rollout

BRUTE® Step-On Rollouts are designed to make managing facility waste easier. With one step, the pedal lifts the lid and allows for hands-free waste disposal.



BRUTE® Step-On Rollout

| NO. | COLOR | DESCRIPTION | U.S. DIMENSIONS | U.S. CAPACITY | U.S. SHIP WT/CTN | METRIC DIMENSIONS | METRIC CAPACITY | METRIC SHIP WT/CTN | PACK |
|---------|-------|------------------------|-----------------------------|---------------|------------------|------------------------------|-----------------|--------------------|------|
| 1971944 | GRAY | BRUTE® Step-On Rollout | 28.6" l x 20.6" w x 37.2" h | 32 gal | 19.2 lb | 72.5 cm x 52.4 cm x 94.4 cm | 120 L | 8.7 kg | 1 |
| 1971946 | BLUE | BRUTE® Step-On Rollout | 28.6" l x 20.6" w x 37.2" h | 32 gal | 19.2 lb | 72.5 cm x 52.4 cm x 94.4 cm | 120 L | 8.7 kg | 1 |
| 1971956 | GRAY | BRUTE® Step-On Rollout | 30.1" l x 24.0" w x 39.6" h | 50 gal | 27.0 lb | 76.4 cm x 60.9 cm x 100.5 cm | 189 L | 12.2 kg | 1 |
| 1971958 | BLUE | BRUTE® Step-On Rollout | 30.1" l x 24.0" w x 39.6" h | 50 gal | 27.0 lb | 76.4 cm x 60.9 cm x 100.5 cm | 189 L | 12.2 kg | 1 |
| 1971968 | GRAY | BRUTE® Step-On Rollout | 32.3" l x 25.3" w x 44.7" h | 65 gal | 35.5 lb | 82.1 cm x 64.3 cm x 113.6 cm | 246 L | 16.1 kg | 1 |
| 1971970 | BLUE | BRUTE® Step-On Rollout | 32.3" l x 25.3" w x 44.7" h | 65 gal | 35.5 lb | 82.1 cm x 64.3 cm x 113.6 cm | 246 L | 16.1 kg | 1 |
| 1971991 | GRAY | BRUTE® Step-On Rollout | 37.2" l x 28.6" w x 46.0" h | 95 gal | 40.0 lb | 94.4 cm x 72.6 cm x 116.9 cm | 360 L | 18.1 kg | 1 |
| 1971993 | BLUE | BRUTE® Step-On Rollout | 37.2" l x 28.6" w x 46.0" h | 95 gal | 40.0 lb | 94.4 cm x 72.6 cm x 116.9 cm | 360 L | 18.1 kg | 1 |

UTILITY REFUSE AND RECYCLING

DECORATIVE REFUSE

CLEANING

MATERIAL HANDLING

WASHROOM

FOODSERVICE

ACCESSORIES & INDEX



BRUTE® Rollout with Casters

BRUTE® Rollouts with Casters are ideal for collecting, consolidating, and transporting heavy facility waste. Front swivel casters distribute weight evenly for superior mobility and handling.

**BRUTE® Rollout With Casters**

| NO. | COLOR | DESCRIPTION | U.S. DIMENSIONS | U.S. CAPACITY | U.S. SHIP WT/CTN | METRIC DIMENSIONS | METRIC CAPACITY | METRIC SHIP WT/CTN | PACK |
|---------|-------------|-----------------------------|-----------------------------|---------------|------------------|------------------------------|-----------------|--------------------|------|
| 1971947 | GRAY | BRUTE® Rollout With Casters | 28.6" l x 20.6" w x 37.2" h | 32 gal | 42.0 lb | 72.5 cm x 52.4 cm x 94.4 cm | 120 L | 19.1 kg | 2 |
| 1971949 | BLUE | BRUTE® Rollout With Casters | 28.6" l x 20.6" w x 37.2" h | 32 gal | 42.0 lb | 72.5 cm x 52.4 cm x 94.4 cm | 120 L | 19.1 kg | 2 |
| 1971959 | GRAY | BRUTE® Rollout With Casters | 30.1" l x 24.0" w x 39.6" h | 50 gal | 58.0 lb | 76.5 cm x 60.9 cm x 100.5 cm | 189 L | 26.3 kg | 2 |
| 1971961 | BLUE | BRUTE® Rollout With Casters | 30.1" l x 24.0" w x 39.6" h | 50 gal | 58.0 lb | 76.5 cm x 60.9 cm x 100.5 cm | 189 L | 26.3 kg | 2 |
| 1971971 | GRAY | BRUTE® Rollout With Casters | 32.3" l x 25.3" w x 44.7" h | 65 gal | 36.0 lb | 82.1 cm x 64.3 cm x 113.6 cm | 246 L | 16.3 kg | 1 |
| 1971973 | BLUE | BRUTE® Rollout With Casters | 32.3" l x 25.3" w x 44.7" h | 65 gal | 36.0 lb | 82.1 cm x 64.3 cm x 113.6 cm | 246 L | 16.3 kg | 1 |
| 1971994 | GRAY | BRUTE® Rollout With Casters | 37.2" l x 28.6" w x 46.0" h | 95 gal | 44.0 lb | 94.4 cm x 72.6 cm x 116.9 cm | 360 L | 20.0 kg | 1 |
| 1971996 | BLUE | BRUTE® Rollout With Casters | 37.2" l x 28.6" w x 46.0" h | 95 gal | 44.0 lb | 94.4 cm x 72.6 cm x 116.9 cm | 360 L | 20.0 kg | 1 |

BRUTE® Step-On Rollout Container With Casters

BRUTE® Step-On Rollouts with Casters facilitate hands-free waste disposal with the added benefit of superior mobility. Front swivel casters distribute weight evenly for enhanced maneuverability.

**BRUTE® Step-On Rollout With Casters**

| NO. | COLOR | DESCRIPTION | U.S. DIMENSIONS | U.S. CAPACITY | U.S. SHIP WT/CTN | METRIC DIMENSIONS | METRIC CAPACITY | METRIC SHIP WT/CTN | PACK |
|---------|-------------|-------------------------------------|-----------------------------|---------------|------------------|------------------------------|-----------------|--------------------|------|
| 1971950 | GRAY | BRUTE® Step-On Rollout With Casters | 28.6" l x 20.6" w x 37.2" h | 32 gal | 22.2 lb | 72.5 cm x 52.4 cm x 94.4 cm | 120 L | 10.1 kg | 1 |
| 1971952 | BLUE | BRUTE® Step-On Rollout With Casters | 28.6" l x 20.6" w x 37.2" h | 32 gal | 22.2 lb | 72.5 cm x 52.4 cm x 94.4 cm | 120 L | 10.1 kg | 1 |
| 1971962 | GRAY | BRUTE® Step-On Rollout With Casters | 30.1" l x 24.0" w x 39.6" h | 50 gal | 30.0 lb | 76.4 cm x 60.9 cm x 100.5 cm | 189 L | 13.6 kg | 1 |
| 1971964 | BLUE | BRUTE® Step-On Rollout With Casters | 30.1" l x 24.0" w x 39.6" h | 50 gal | 30.0 lb | 76.4 cm x 60.9 cm x 100.5 cm | 189 L | 13.6 kg | 1 |
| 1971974 | GRAY | BRUTE® Step-On Rollout With Casters | 32.3" l x 25.3" w x 44.7" h | 65 gal | 37.0 lb | 82.1 cm x 64.3 cm x 113.6 cm | 246 L | 16.8 kg | 1 |
| 1971976 | BLUE | BRUTE® Step-On Rollout With Casters | 32.3" l x 25.3" w x 44.7" h | 65 gal | 37.0 lb | 82.1 cm x 64.3 cm x 113.6 cm | 246 L | 16.8 kg | 1 |
| 1971997 | GRAY | BRUTE® Step-On Rollout With Casters | 37.2" l x 28.6" w x 46.0" h | 95 gal | 46.0 lb | 94.4 cm x 72.6 cm x 116.9 cm | 360 L | 20.9 kg | 1 |
| 1971999 | BLUE | BRUTE® Step-On Rollout With Casters | 37.2" l x 28.6" w x 46.0" h | 95 gal | 46.0 lb | 94.4 cm x 72.6 cm x 116.9 cm | 360 L | 20.9 kg | 1 |



FG9W2773

FG9W1188

Recycling Rollout Containers

| NO. | COLOR | DESCRIPTION | U.S. DIMENSIONS | U.S. CAPACITY | U.S. SHIP WT/CTN | METRIC DIMENSIONS | METRIC CAPACITY | METRIC SHIP WT/CTN | PACK |
|----------|-------|---|-----------------------------|---------------|------------------|-----------------------------|-----------------|--------------------|------|
| FG9W2773 | BLUE | BRUTE® Recycling Rollout Container with Lid | 28.5" l x 23.4" w x 36.5" h | 50 gal | 43.6 lb | 72.4 cm x 59.4 cm x 92.7 cm | 189.3 L | 19.8 kg | 2 |
| 1977788 | | Waste Stream Label Kit Version D fits 50-Gallon BRUTE® Rollout Containers | 10.3" w x 2.6" h | | | | | | 1 |

Confidential Document Rollout Containers

| NO. | COLOR | DESCRIPTION | U.S. DIMENSIONS | U.S. CAPACITY | U.S. SHIP WT/CTN | METRIC DIMENSIONS | METRIC CAPACITY | METRIC SHIP WT/CTN | PACK |
|----------|-------|--|-----------------------------|---------------|------------------|------------------------------|-----------------|--------------------|------|
| FG9W1088 | GRAY | BRUTE® Confidential Document Rollout Container | 31.5" l x 25.3" w x 41.8" h | 65 gal | 31.0 lb | 80.0 cm x 64.2 cm x 106.2 cm | 246.05 L | 14.1 kg | 1 |
| FG9W1188 | GRAY | BRUTE® Confidential Document Rollout Container | 35.4" l x 27.3" w x 45.6" h | 95 gal | 36.5 lb | 89.9 cm x 69.3 cm x 115.8 cm | 359.6 L | 16.5 kg | 1 |

BRUTE® Medical Waste Rollout Containers

BRUTE® Medical Waste Rollouts with Casters are designed for use in the healthcare industry. Locking lids keep regulated medical waste secure, smooth contours make cleaning easier, and front swivel casters enable balanced maneuverability.



BRUTE® Medical Waste Rollout With Casters

| NO. | COLOR | DESCRIPTION | U.S. DIMENSIONS | U.S. CAPACITY | U.S. SHIP WT/CTN | METRIC DIMENSIONS | METRIC CAPACITY | METRIC SHIP WT/CTN | PACK |
|---------|-------|---|-----------------------------|---------------|------------------|------------------------------|-----------------|--------------------|------|
| 1971977 | RED | BRUTE® Medical Waste Rollout With Casters | 32.3" l x 25.3" w x 44.7" h | 65 gal | 36.0 lb | 82.1cm x 64.3 cm x 113.6 cm | 246 L | 16.3 kg | 1 |
| 1972000 | RED | BRUTE® Medical Waste Rollout With Casters | 37.2" l x 28.6" w x 46.0" h | 95 gal | 44.0 lb | 94.3 cm x 72.6 cm x 116.8 cm | 360 L | 20.0 kg | 1 |



1971977 and 1971976



SLIM JIM® CONTAINERS



80% EASIER TO LIFT LINERS

The Slim Jim® container is designed with four built-in venting channels that create airflow throughout the container. This air circulation reduces the vacuum effect that occurs when lifting out liners in traditional containers. By reducing the pull force required to lift out liners by up to 80%, the Slim Jim® container improves productivity and reduces the risk of injury.

IMPROVED PRODUCTIVITY



SlimJim®

UTILITY REFUSE
AND RECYCLING



VENTING CHANNELS

Make removing liners up to 80% easier, improving productivity and reducing the risk of worker injury.



BAG CINCHES

Secure liners around the rim of the container and allow for quick, knot-free liner changes.



BASE AND RIM HANDLES

Improve grip and control while lifting and emptying full containers.



MULTIPLE DOLLY OPTIONS

Allow for efficient collection and transportation of up to four Slim Jim® containers.



DECORATIVE REFUSE

CLEANING

MATERIAL HANDLING

WASHROOM

FOODSERVICE

ACCESSORIES
& INDEX

Slim Jim® Containers with Venting Channels

Slim Jim® Containers with venting channels deliver the most efficient solution for collection, transportation, and disposal of multi-stream waste and recyclables.

- Venting channels make removing liners up to 80% easier, improving productivity and reducing the risk of worker injury*
- Four bag cinches secure liners around the rim of the container and allow for quick, knot-free liner changes
- Handles at the base and rim of the container improve grip and control while lifting and emptying full containers
- Rim with rib-strengthened design increases strength and resists crushing
- Build a recycling station with a variety of dolly and lid options to meet any facility need
- Use Waste Stream Label Kit Version E (1977789) to ensure waste sortation accuracy. See more on page 44.



1971258

FG354060GRAY



Can Liner Cinches

Four pull-through holes and can liner cinches eliminate knot tying.



1956185

1956186

1956187

1956188

1956189

FG354060BLA

FG354060BEIG

| NO. | COLOR | DESCRIPTION | U.S. DIMENSIONS | U.S. CAPACITY | U.S. SHIP WT/CTN | METRIC DIMENSIONS | METRIC CAPACITY | METRIC SHIP WT/CTN | CAN LINERS | PACK |
|------------|------------------------|---|-----------------------------|---------------|------------------|-----------------------------|-----------------|--------------------|------------|------|
| 1971258 | GRAY | Slim Jim® Container with Venting Channels | 22.0" l x 11.0" w x 25.0" h | 16 gal | 26.0 lb | 55.9 cm x 27.9 cm x 63.5 cm | 60.6 L | 11.8 kg | 5009-88A | 4 |
| 1971259 | BEIGE | Slim Jim® Container with Venting Channels | 22.0" l x 11.0" w x 25.0" h | 16 gal | 26.0 lb | 55.9 cm x 27.9 cm x 63.5 cm | 60.6 L | 11.8 kg | 5009-88A | 4 |
| 1956181 | BROWN | Slim Jim® Container with Venting Channels | 22.0" l x 11.0" w x 25.0" h | 16 gal | 26.0 lb | 55.9 cm x 27.9 cm x 63.5 cm | 60.6 L | 11.8 kg | 5009-88A | 4 |
| 1971257 | BLUE | Slim Jim® Container with Venting Channels | 22.0" l x 11.0" w x 25.0" h | 16 gal | 26.0 lb | 55.9 cm x 27.9 cm x 63.5 cm | 60.6 L | 11.8 kg | 5009-88A | 4 |
| 1955960 | GREEN | Slim Jim® Container with Venting Channels | 22.0" l x 11.0" w x 25.0" h | 16 gal | 26.0 lb | 55.9 cm x 27.9 cm x 63.5 cm | 60.6 L | 11.8 kg | 5009-88A | 4 |
| 1955959 | BLACK | Slim Jim® Container with Venting Channels | 22.0" l x 11.0" w x 25.0" h | 16 gal | 26.0 lb | 55.9 cm x 27.9 cm x 63.5 cm | 60.6 L | 11.8 kg | 5009-88A | 4 |
| FG354060** | GRAY, BEIG, BLA | Slim Jim® Container with Venting Channels | 22.0" l x 11.0" w x 30.0" h | 23 gal | 31.8 lb | 55.9 cm x 27.9 cm x 76.2 cm | 87.1 L | 14.4 kg | 5009-88A | 4 |
| 1956187 | BROWN | Slim Jim® Container with Venting Channels | 22.0" l x 11.0" w x 30.0" h | 23 gal | 31.8 lb | 55.9 cm x 27.9 cm x 76.2 cm | 87.1 L | 14.4 kg | 5009-88A | 4 |
| 1956185 | BLUE | Slim Jim® Container with Venting Channels | 22.0" l x 11.0" w x 30.0" h | 23 gal | 31.8 lb | 55.9 cm x 27.9 cm x 76.2 cm | 87.1 L | 14.4 kg | 5009-88A | 4 |
| 1956189 | RED | Slim Jim® Container with Venting Channels | 22.0" l x 11.0" w x 30.0" h | 23 gal | 31.8 lb | 55.9 cm x 27.9 cm x 76.2 cm | 87.1 L | 14.4 kg | 5009-88A | 4 |
| 1956188 | YELLOW | Slim Jim® Container with Venting Channels | 22.0" l x 11.0" w x 30.0" h | 23 gal | 31.8 lb | 55.9 cm x 27.9 cm x 76.2 cm | 87.1 L | 14.4 kg | 5009-88A | 4 |
| 1956186 | GREEN | Slim Jim® Container with Venting Channels | 22.0" l x 11.0" w x 30.0" h | 23 gal | 31.8 lb | 55.9 cm x 27.9 cm x 76.2 cm | 87.1 L | 14.4 kg | 5009-88A | 4 |
| FG354007 | BLUE, GRN | Slim Jim® Container with Venting Channels – Recycling | 22.0" l x 11.0" w x 30.0" h | 23 gal | 31.8 lb | 55.9 cm x 27.9 cm x 76.2 cm | 87.1 L | 14.4 kg | 5009-88A | 4 |

*Based on internal testing.

**Custom imprinting available; contact Rubbermaid Customer Service at (800) 347-9800 for details.

UTILITY REFUSE AND RECYCLING

DECORATIVE REFUSE

CLEANING

MATERIAL HANDLING

WASHROOM

FOODSERVICE

ACCESSORIES & INDEX

Slim Jim® Accessories

Promote recycling and improve productivity.

Stainless Steel Dollies

- Collect and transport up to four streams of waste and recyclables with the new stainless steel multi-dollies for Slim Jim® containers
- Constructed from high quality stainless steel material that is easy to clean and won't rust or chip in commercial environments
- Features 3" nonmarking quiet casters that allow for smooth and quiet maneuverability
- Locking feature on casters creates a stable recycling station or collection site
- Fits both 16- and 23-gallon Slim Jim® Vented Containers

Resin Trainable Dolly

- Features a side clip-on connection that allows you to train several dollies together for collection and transportation purposes
- Foot pedal release makes disconnecting dollies quick and easy
- Structural foam construction ensures maximum durability in commercial environments
- Fits both 16- and 23-gallon Slim Jim® Vented Containers



1956192 with FG354060BLA / 1956185 / 1956186



1980602

Dollies

| NO | COLOR | DESCRIPTION | U.S. DIMENSIONS | U.S. CAPACITY | U.S. SHIP WT/CTN | METRIC DIMENSIONS | METRIC CAPACITY | METRIC SHIP WT/CTN | PACK |
|---------|-----------|---|----------------------------|---------------|------------------|-----------------------------|-----------------|--------------------|------|
| 1968468 | Stainless | Slim Jim® Stainless Steel Dolly for Slim Jim® Containers – Single | 20.0" l x 9.3" w x 9.0" h | 100.0 lb | 11.6 lb | 50.8 cm x 23.6 cm x 22.9 cm | 45.4 kg | 5.2 kg | 2 |
| 1956191 | Stainless | Slim Jim® Stainless Steel Dolly for Slim Jim® Containers – Double | 20.0" l x 20.6" w x 9.0" h | 200.0 lb | 9.9 lb | 50.8 cm x 52.3 cm x 22.9 cm | 90.7 kg | 4.5 kg | 1 |
| 1956192 | Stainless | Slim Jim® Stainless Steel Dolly for Slim Jim® Containers – Triple | 20.0" l x 32.5" w x 9.0" h | 300.0 lb | 13.6 lb | 50.8 cm x 82.6 cm x 22.9 cm | 136.1 kg | 6.2 kg | 1 |
| 1980602 | Black | Slim Jim® Resin Trainable Dolly for Slim Jim® Containers | 23.9" l x 14.7" w x 8.4" h | 120.0 lb | 11.9 lb | 60.7 cm x 37.3 cm x 21.3 cm | 54.4 kg | 5.4 kg | 2 |



Slim Jim® Cleaning Accessories

Slim Jim® Cleaning Accessories make mobile waste collection and cleaning in tight spaces easier than ever. Mix and match Slim Jim® cleaning accessories, containers, and dollies to suit any space.

Rim Caddy

- The Slim Jim® Rim Caddy paired with the slim profile of a Slim Jim® container allows for easy maneuvering in the tightest spaces.
- Fits securely on the rim of a Slim Jim® container, allowing for the storage and transportation of common cleaning tools. The Slim Jim® Rim Caddy features an integrated dustpan holder, dedicated hooks to hold a safety sign, and space for storing up to 3 spray bottles.
- Rim Caddies can be linked together for efficient multi-stream waste collection.
- Each Slim Jim® Rim Caddy includes a Stick Clip, Wide Hook, and Peg Hook that can be arranged into hundreds of different configurations onto five dedicated tool rails.
- Commercial-grade construction with high-quality resin material.



2032940



2032955



2032936

| NO | COLOR | DESCRIPTION | PARTS INCLUDED | U.S. DIMENSIONS | U.S. SHIP WT/CTN | METRIC DIMENSIONS | METRIC SHIP WT/CTN | PACK |
|---------|--------|---|---|-----------------------------|------------------|-----------------------------|--------------------|------|
| 2032955 | Yellow | Slim Jim® Rim Caddy for 23 G Containers | Rim Caddy, Stick Clip, Wide Hook, Peg Hook | 32.5" l x 14.3" w x 4.8" h | 5.7 lb | 82.6 cm x 36.2 cm x 12.1 cm | 2.6 kg | 1 |
| 2032940 | Black | Slim Jim® Rim Caddy for 23 G Containers | Rim Caddy, Stick Clip, Wide Hook, Peg Hook | 32.5" l x 14.3" w x 4.8" h | 5.7 lb | 82.6 cm x 36.2 cm x 12.1 cm | 2.6 kg | 1 |
| 2032954 | Yellow | Slim Jim® Rim Caddy Kit | Rim Caddy, Stick Clip, Wide Hook, Peg Hook, 23G Black Vented Slim Jim®, Resin Trainable Dolly | 34.3" l x 14.1" w x 35.8" h | 22.4 lb | 87.1 cm x 35.9 cm x 90.8 cm | 10.2 kg | 1 |
| 2032953 | Black | Slim Jim® Rim Caddy Kit | Rim Caddy, Stick Clip, Wide Hook, Peg Hook, 23G Black Vented Slim Jim® Container, Resin Trainable Dolly | 34.3" l x 14.1" w x 35.8" h | 22.4 lb | 87.1 cm x 35.9 cm x 90.8 cm | 10.2 kg | 1 |
| 2032952 | Yellow | Slim Jim® 2-Stream Rim Caddy Kit | (2) Rim Caddies, (2) Stick Clips, (2) Wide Hooks, (2) Peg Hooks, (2) 23G Vented Slim Jim® Containers (1 Black, 1 Blue), (2) Resin Trainable Dollies | 34.3" l x 27.0" w x 35.8" h | 42.6 lb | 87.0 cm x 68.6 cm x 90.8 cm | 19.3 kg | 1 |
| 2032936 | Black | Slim Jim® 2-Stream Rim Caddy Kit | (2) Rim Caddies, (2) Stick Clips, (2) Wide Hooks, (2) Peg Hooks, (2) 23G Vented Slim Jim® Containers (1 Black, 1 Blue), (2) Resin Trainable Dollies | 34.3" l x 27.0" w x 35.8" h | 42.6 lb | 87.0 cm x 68.6 cm x 90.8 cm | 19.3 kg | 1 |

Tool Clips

- Slim Jim® Clips can be arranged into hundreds of different configurations for adaptable onboard storage.



2032938

Stick Clip:

Use the Stick Clip to store and transport brooms, dustpans, flat mops, and other long-handled tools.



2032935

Wide Hook:

Use the Wide Hook to store and transport safety signs, linen bags, and microfiber cloths.



2032937

Peg Hook:

Use the Peg Hook to store and transport dusters, scrub brushes, and other small hand tools.



2034272

PULSE™ Mop Clip:

Use the PULSE™ Mop Clip with the Rubbermaid PULSE™ Microfiber Floor Cleaning System. See more on page 83.

| NO | COLOR | DESCRIPTION | PARTS INCLUDED | U.S. DIMENSIONS | U.S. SHIP WT/CTN | METRIC DIMENSIONS | METRIC SHIP WT/CTN | PACK |
|---------|-------|--|---------------------|--------------------------|------------------|----------------------------|--------------------|------|
| 2032938 | Gray | Slim Jim® Stick Clip for 16 and 23 G Containers | (2) Stick Clips | 3.5" l x 2.5" w x 2.5" h | 2.0 lb | 8.9 cm x 6.4 cm x 6.4 cm | 0.91 kg | 6 |
| 2032935 | Gray | Slim Jim® Wide Hook for 16 and 23 G Containers | (2) Wide Hooks | 1.9" l x 1.9" w x 1.3" h | 0.6 lb | 4.8 cm x 4.8 cm x 3.3 cm | 0.26 kg | 6 |
| 2032937 | Gray | Slim Jim® Peg Hook for 16 and 23 G Containers | (2) Peg Hooks | 1.9" l x 1.9" w x 1.3" h | 0.4 lb | 4.8 cm x 4.8 cm x 3.3 cm | 0.20 kg | 6 |
| 2034272 | Gray | Rubbermaid PULSE™ Mop Clip for Slim Jim® Rim Caddy | (1) PULSE™ Mop Clip | 4.0" l x 5.0" w x 1.5" h | 1.1 lb | 10.2 cm x 12.7 cm x 3.8 cm | 0.48 kg | 6 |

Caddy Bag

- The Slim Jim® Caddy Bag maximizes space efficiency by providing onboard storage for all of the supplies needed for cleaning and liner changes on-the-go.
- The Slim Jim® Caddy Bag paired with the slim profile of a Slim Jim® container allows for easy maneuvering in the tightest spaces.
- Features 19 pockets to store and transport common cleaning tools for quick cleanups and mobile waste collection.
- Durable vinyl construction stands up to the toughest commercial environments and is easy to clean.



| NO | COLOR | DESCRIPTION | PARTS INCLUDED | U.S. DIMENSIONS | U.S. SHIP WT/CTN | METRIC DIMENSIONS | METRIC SHIP WT/CTN | PACK |
|---------|--------|---|----------------|---------------------------|------------------|----------------------------|--------------------|------|
| 2032951 | Yellow | Slim Jim® Caddy Bag for 23 G Containers | (1) Caddy Bag | 19.0" l x 8.0" w x 3.0" h | 14.75 lb | 48.3 cm x 20.3 cm x 7.6 cm | 6.69 kg | 6 |
| 2032939 | Black | Slim Jim® Caddy Bag for 23 G Containers | (1) Caddy Bag | 19.0" l x 8.0" w x 3.0" h | 14.75 lb | 48.3 cm x 20.3 cm x 7.6 cm | 6.69 kg | 6 |

Commonly Sold With Items

EXECUTIVE 22" HYGEN™ MULTIPURPOSE FLEXIBLE MICROFIBER DUSTER AND FRAME



FGQ85200

32 OZ EXECUTIVE SPRAY BOTTLE



FG9C0306

HYGEN™ MICROFIBER BATHROOM CLOTH



FGQ61000

EXECUTIVE 16" HYGEN™ GLASS MICROFIBER CLOTH



1867398

EXECUTIVE LOBBY PRO® DUST PAN



FG253100

EXECUTIVE LOBBY BROOM WITH WOOD HANDLE



FG253600

2-SIDED FLOOR SIGN WITH MULTILINGUAL "CAUTION"



FG611200

2-SIDED EXECUTIVE MULTILINGUAL CAUTION SIGN



1867506

| NO | COLOR | DESCRIPTION | U.S. DIMENSIONS | U.S. SHIP WT/CTN | METRIC DIMENSIONS | METRIC SHIP WT/CTN | PACK |
|----------|-------|---|--|------------------|--|--------------------|------|
| FGQ85200 | WHOO | Executive 22" HYGEN™ Multipurpose Flexible Microfiber Duster and Framer | 28.4" l x 1.13" w x 1.13" h | 5.0 lb | 72.1 cm x 2.9 cm x 2.9 cm | 2.3 kg | 6 |
| FG9C0306 | 0000 | Executive Spray Bottle, 32-oz. | 4.8" l x 1.3" w x 13.4" h | 4.5 lb | 12.2 cm x 3.3 cm x 34 cm | 2.1 kg | 12 |
| FGQ61000 | YLOO | HYGEN™ Microfiber Bathroom Cloth (Yellow) | 16" l x 16" w | 0.6 lb | 40.6 cm x 40.6 cm | 0.3 kg | 12 |
| 1867398 | GRAY | Executive 16" HYGEN™ Glass Microfiber Cloth | 16" l x 16" w | 1.8 lb | 40.6 cm x 40.6 cm | 0.8 kg | 12 |
| FG253100 | BLA | Executive Lobby Pro® Dust Pan, Long Handle | 12.8" l x 11.3" w x 5" h | 13.0 lb | 32.5 cm x 28.7 cm x 12.7 cm | 5.9 kg | 6 |
| FG253600 | BLA | Executive Lobby Broom w/ Wood Handle | 7" l x 37.5" h | 2.0 lb | 17.8 cm x 95.3 cm | 0.9 kg | 12 |
| FG611200 | YEL | Floor Sign with Multilingual "Caution" Imprint, 2-Sided | Open: 26" l x 11" w x 25" h Closed: 26" l x 11" w | 15.0 lb | Open: 66 cm x 27.9 cm x 63.5 cm Closed: 66 cm x 27.9 cm | 6.8 kg | 6 |
| 1867506 | GRAY | Executive Multilingual Caution Sign, 2-Sided, | Open: 26" l x 11" w x 25" h Closed: 26" l x 11" w | 15.0 lb | Open: 66 cm x 27.9 cm x 63.5 cm Closed: 66 cm x 27.9 cm | 6.8 kg | 6 |



Slim Jim® Recycling Lids

Intuitive recycling lids with color-coding options ensure recyclables get into the right bins.

- Lids are available with the following lid openings: Open top, Bottles/Cans, Paper, and Mixed Recycling
- Integrated billboard is sized to fit compatible waste stream labels
- Material Composition: Polypropylene
- Fits: 16 Gal and 23 Gal Slim Jim® containers
- **Use Waste Stream Label Kit Version F (2018391) to ensure waste sortation accuracy. See more on page 44.**



Open Top
2018252



Bottles/Cans
2018258



Paper
2018276



Mixed Recycling
2018302

Slim Jim® Vertical Recycling Lids

| NO. | COLOR | DESCRIPTION | U.S. DIMENSIONS | U.S. SHIP WT/CTN | PACK |
|---------|--------|--|----------------------------|------------------|------|
| 2018252 | Blue | Slim Jim® Vertical Lid – Open Top | 20.4" l x 11.5" w x 6.0" h | | 4 |
| 2018218 | Red | Slim Jim® Vertical Lid – Open Top | 20.4" l x 11.5" w x 6.0" h | | 4 |
| 2018219 | Yellow | Slim Jim® Vertical Lid – Open Top | 20.4" l x 11.5" w x 6.0" h | | 4 |
| 2018220 | Green | Slim Jim® Vertical Lid – Open Top | 20.4" l x 11.5" w x 6.0" h | | 4 |
| 2018253 | Black | Slim Jim® Vertical Lid – Open Top | 20.4" l x 11.5" w x 6.0" h | | 4 |
| 2018254 | Brown | Slim Jim® Vertical Lid – Open Top | 20.4" l x 11.5" w x 6.0" h | | 4 |
| 2018258 | Blue | Slim Jim® Vertical Lid – Bottles/Cans | 20.4" l x 11.5" w x 6.0" h | | 4 |
| 2018255 | Red | Slim Jim® Vertical Lid – Bottles/Cans | 20.4" l x 11.5" w x 6.0" h | | 4 |
| 2018256 | Yellow | Slim Jim® Vertical Lid – Bottles/Cans | 20.4" l x 11.5" w x 6.0" h | | 4 |
| 2018257 | Green | Slim Jim® Vertical Lid – Bottles/Cans | 20.4" l x 11.5" w x 6.0" h | | 4 |
| 2018260 | Brown | Slim Jim® Vertical Lid – Bottles/Cans | 20.4" l x 11.5" w x 6.0" h | | 4 |
| 2018276 | Blue | Slim Jim® Vertical Lid – Paper | 20.4" l x 11.5" w x 6.0" h | | 4 |
| 2018272 | Red | Slim Jim® Vertical Lid – Paper | 20.4" l x 11.5" w x 6.0" h | | 4 |
| 2018274 | Yellow | Slim Jim® Vertical Lid – Paper | 20.4" l x 11.5" w x 6.0" h | | 4 |
| 2018275 | Green | Slim Jim® Vertical Lid – Paper | 20.4" l x 11.5" w x 6.0" h | | 4 |
| 2018278 | Brown | Slim Jim® Vertical Lid – Paper | 20.4" l x 11.5" w x 6.0" h | | 4 |
| 2018302 | Blue | Slim Jim® Vertical Lid – Mixed Recycling | 20.4" l x 11.5" w x 6.0" h | | 4 |
| 2018279 | Red | Slim Jim® Vertical Lid – Mixed Recycling | 20.4" l x 11.5" w x 6.0" h | | 4 |
| 2018280 | Yellow | Slim Jim® Vertical Lid – Mixed Recycling | 20.4" l x 11.5" w x 6.0" h | | 4 |
| 2018301 | Green | Slim Jim® Vertical Lid – Mixed Recycling | 20.4" l x 11.5" w x 6.0" h | | 4 |
| 2018304 | Brown | Slim Jim® Vertical Lid – Mixed Recycling | 20.4" l x 11.5" w x 6.0" h | | 4 |

Slim Jim® Lids

- Encourage waste separation and recycling with interchangeable, color-coded lids
- Swing Lid conceals waste from view and provides no-touch access
- Hinged Lid folds flat while in use and completely covers waste when closed; complies with Health and Human Services Standard



Handle Top Lid
FG268888GRAY



Bottles and Cans Lid
FG269288BLUE



Swing Lid
FG267360GRAY



Hinged Lid
FG267400BLA

| NO. | COLOR | DESCRIPTION | U.S. DIMENSIONS | U.S. SHIP WT/CTN | PACK |
|-----------|---------------------------------|---|----------------------------|------------------|------|
| FG268888L | GRAY | Slim Jim® Handle Top | 20.4" l x 11.2" w x 3.8" h | 4.1 lb | 4 |
| FG267360 | BEIG, BLA, BLUE, GRAY | Slim Jim® Swing Lid for Slim Jim® Containers | 20.5" l x 11.7" w x 5.0" h | 12.5 lb | 4 |
| 1829400 | GREEN | Slim Jim® Swing Lid for Slim Jim® Containers | 20.5" l x 11.4" w x 5.0" h | 12.5 lb | 4 |
| FG269288 | BLUE, BRN, GRN, RED, YEL | Slim Jim® Bottles and Cans Recycling Lid for Slim Jim® Containers | 20.4" l x 11.3" w x 2.8" h | 3.9 lb | 4 |
| FG270388 | BLUE, GRN | Slim Jim® Paper Recycling Lid for Slim Jim® Containers | 20.5" l x 11.5" w x 2.8" h | 4.1 lb | 4 |
| 1788372 | BLUE | Slim Jim® Mixed Recycling Lid for Slim Jim® Containers | 21.1" l x 12.1" w x 2.8" h | 5.4 lb | 4 |
| 1788373 | GRN | Slim Jim® Recycling Mixed Lid Green | 20.5" l x 11.5" w x 2.8" h | 4.1 lb | 4 |
| FG267400 | BLA | Executive Slim Jim® Hinged Lid for Slim Jim® Containers | 21.0" l x 13.5" w x 1.2" h | 6.5 lb | 4 |
| FG9W1600L | GRAY | Slim Jim® Confidential Document Lid | 20.4" l x 11.4" w x 2.1" h | | 4 |



956185/2018276, 1955959/2018253

AN ADAPTABLE

RECYCLING SOLUTION

Customized recycling—Facilities can choose from 7 colors and 4 lid openings to customize a recycling station that fits their unique recycling needs.





7 COLORS

Color-coding creates consistent visual cues for patrons and staff when sorting recyclables.



4 LID OPTIONS

Restrictive lid shapes ensure the right recyclables get into the right bins. For an open top option, no insert needed.



Mixed Recycling Paper Bottles / Cans Closed



10 WASTE STREAM LABELS

Expert designed waste stream labels feature 3 visual cues: the recycling symbol, a waste stream icon, and verbiage proven to increase recycling effectiveness.



Slim Jim® Recycling Station

Select a pre-made kit (Option 1) or create your own station (Option 2) by selecting from the offerings of lid inserts, billboards, and waste stream labels, in combination with a starter kit.

Slim Jim® Recycling Station – Pre-Made Kits (Option 1)

Select from a variety of pre-determined multi-stream stations to fit your unique recycling need.

- Intuitive lid openings help patrons and staff sort recyclables more effectively
- Provide better waste stream visibility by selecting a color and waste stream label for your facility needs
- Hinging lid inserts are optimized to fit any size recyclable
- Simple and durable execution. Components snap in place without the use of hardware
- Waste Stream Label Kit is included in Recycling Kit



2007919

| NO. | COLOR | DESCRIPTION | U.S. DIMENSIONS | U.S. CAPACITY | U.S. SHIP WT/CTN | METRIC DIMENSIONS | METRIC SHIP WT/CTN | PACK |
|---------|-----------------------|---|-----------------------------|-----------------------------|------------------|--------------------------------|--------------------|------|
| 2007914 | Black/Blue | 2-Stream Station Landfill/Mixed Recycling | 21.5" l x 24.0" w x 40.3" h | 23 gal/23 gal | 12.5 lb | 54.6 cm x 60.9 cm x 102.25 cm | 5.6 kg | 1 |
| 2007915 | Black/Blue | 2-Stream Station Landfill/Paper | 21.5" l x 24.0" w x 40.3" h | 23 gal/23 gal | 24.0 lb | 54.6 cm x 60.9 cm x 102.25 cm | 10.9 kg | 1 |
| 2007916 | Black/Yellow | 2-Stream Station Landfill/Bottles/Cans | 21.5" l x 24.0" w x 40.3" h | 23 gal/23 gal | 24.0 lb | 54.6 cm x 60.9 cm x 102.25 cm | 10.9 kg | 1 |
| 2007917 | Black/Blue/Yellow | 3-Stream Station Landfill/Paper/Bottles/Cans | 21.5" l x 36.0" w x 40.3" h | 23 gal/23 gal/23 gal | 37.1 lb | 54.6 cm x 91.4 cm x 102.25 cm | 16.8 kg | 1 |
| 2007918 | Black/Blue/Green | 3-Stream Station Landfill/Mixed Recycling/Compost | 21.5" l x 36.0" w x 40.3" h | 23 gal/23 gal/23 gal | 37.1 lb | 54.6 cm x 91.4 cm x 102.25 cm | 16.8 kg | 1 |
| 2007919 | Black/Blue/Red/Yellow | 4-Stream Station Landfill/Paper/Plastic/Cans | 21.5" l x 48.0" w x 40.3" h | 23 gal/23 gal/23 gal/23 gal | 47.3 lb | 54.6 cm x 121.9 cm x 102.25 cm | 21.5 kg | 1 |

Slim Jim® Recycling Station – Create Your Own Station (Option 2)

An adaptable recycling solution offers a front-of-house look with back-of-house functionality.

- Starter Kit includes a base, lid, and connector. Lid Inserts and Billboards sold separately.
- You will need as many starter kits as streams you want in your station.
- Intuitive lid openings help patrons and staff sort recyclables more effectively.
- Provide better waste stream visibility by selecting a color and waste stream label for your facility needs.
- Hinging lid inserts are optimized to fit any size recyclable.
- Simple and durable execution. Components snap in place without the use of hardware.



2007913



1 SELECT A STARTER KIT

Build your own station by selecting the starter kit: A Base, Lid, and Connector.



2 CHOOSE A LID INSERT

Choose your color and opening type: Mixed Recycle, Paper, Bottles/Cans, and Closed.



3 COORDINATE THE BILLBOARD

Choose the color to match your lid inserts: Blue, Red, Yellow, Green, Brown, Dark Gray, and Black.



4 ADD A WASTE STREAM LABEL

Choose from ten waste stream labels to complete the station.

Slim Jim® Recycling Station – Starter Kit

| NO. | COLOR | DESCRIPTION | U.S. DIMENSIONS | U.S. CAPACITY | U.S. SHIP WT/CTN | METRIC DIMENSIONS | METRIC SHIP WT/CTN | PACK |
|---------|------------|-------------|-----------------------------|---------------|------------------|------------------------------|--------------------|------|
| 2007913 | Light Gray | Starter Kit | 21.5" l x 12.0" w x 34.3" h | 23 gal | 11.8 lb | 54.6 cm x 30.5 cm x 87.05 cm | 5.4 kg | 1 |

When ordering products with **BOLD** color codes, please specify color code after the product number. Refer to the Standard Color Guide at the back of the catalog.

UTILITY REFUSE AND RECYCLING

DECORATIVE REFUSE

CLEANING

MATERIAL HANDLING

WASHROOM

FOODSERVICE

ACCESSORIES & INDEX

Slim Jim® Recycling Station – Lid Inserts

- Intuitive lid openings help patrons and staff sort recyclables more effectively.
- Hinging lid inserts are optimized to fit any size recyclable
- Components snap in place without the use of hardware
- Compatible with Slim Jim® Recycling Station Starter Kit



| NO. | COLOR | DESCRIPTION | U.S. SHIP WT/CTN | U.S. DIMENSIONS | METRIC SHIP WT/CTN | PACK |
|---------|-----------|----------------------------|------------------|---------------------------|--------------------|------|
| 2007192 | Red | Closed Lid Insert | 0.8 lb | 16.5" l x 8.0" w x 0.5" h | 0.3 kg | 1 |
| 2007193 | Red | Bottles/Cans Lid Insert | 0.8 lb | 16.5" l x 8.0" w x 0.5" h | 0.3 kg | 1 |
| 2007194 | Red | Paper Slot Lid Insert | 0.8 lb | 16.5" l x 8.0" w x 0.5" h | 0.3 kg | 1 |
| 2007195 | Red | Mixed Recycling Lid Insert | 0.8 lb | 16.5" l x 8.0" w x 0.5" h | 0.3 kg | 1 |
| 2007200 | Yellow | Closed Lid Insert | 0.8 lb | 16.5" l x 8.0" w x 0.5" h | 0.3 kg | 1 |
| 2007881 | Yellow | Bottles/Cans Lid Insert | 0.8 lb | 16.5" l x 8.0" w x 0.5" h | 0.3 kg | 1 |
| 2007882 | Yellow | Paper Slot Lid Insert | 0.8 lb | 16.5" l x 8.0" w x 0.5" h | 0.3 kg | 1 |
| 2007883 | Yellow | Mixed Recycling Lid Insert | 0.8 lb | 16.5" l x 8.0" w x 0.5" h | 0.3 kg | 1 |
| 2007884 | Green | Closed Lid Insert | 0.8 lb | 16.5" l x 8.0" w x 0.5" h | 0.3 kg | 1 |
| 2007885 | Green | Bottles/Cans Lid Insert | 0.8 lb | 16.5" l x 8.0" w x 0.5" h | 0.3 kg | 1 |
| 2007886 | Green | Paper Slot Lid Insert | 0.8 lb | 16.5" l x 8.0" w x 0.5" h | 0.3 kg | 1 |
| 2007887 | Green | Mixed Recycling Lid Insert | 0.8 lb | 16.5" l x 8.0" w x 0.5" h | 0.3 kg | 1 |
| 2007888 | Blue | Closed Lid Insert | 0.8 lb | 16.5" l x 8.0" w x 0.5" h | 0.3 kg | 1 |
| 2007889 | Blue | Bottles/Cans Lid Insert | 0.8 lb | 16.5" l x 8.0" w x 0.5" h | 0.3 kg | 1 |
| 2007890 | Blue | Paper Slot Lid Insert | 0.8 lb | 16.5" l x 8.0" w x 0.5" h | 0.3 kg | 1 |
| 2007891 | Blue | Mixed Recycling Lid Insert | 0.8 lb | 16.5" l x 8.0" w x 0.5" h | 0.3 kg | 1 |
| 2007892 | Black | Closed Lid Insert | 0.8 lb | 16.5" l x 8.0" w x 0.5" h | 0.3 kg | 1 |
| 2007893 | Black | Bottles/Cans Lid Insert | 0.8 lb | 16.5" l x 8.0" w x 0.5" h | 0.3 kg | 1 |
| 2007894 | Black | Paper Slot Lid Insert | 0.8 lb | 16.5" l x 8.0" w x 0.5" h | 0.3 kg | 1 |
| 2007895 | Black | Mixed Recycling Lid Insert | 0.8 lb | 16.5" l x 8.0" w x 0.5" h | 0.3 kg | 1 |
| 2007896 | Dark Gray | Closed Lid Insert | 0.8 lb | 16.5" l x 8.0" w x 0.5" h | 0.3 kg | 1 |
| 2007897 | Dark Gray | Bottles/Cans Lid Insert | 0.8 lb | 16.5" l x 8.0" w x 0.5" h | 0.3 kg | 1 |
| 2007898 | Dark Gray | Paper Slot Lid Insert | 0.8 lb | 16.5" l x 8.0" w x 0.5" h | 0.3 kg | 1 |
| 2007899 | Dark Gray | Mixed Recycling Lid Insert | 0.8 lb | 16.5" l x 8.0" w x 0.5" h | 0.3 kg | 1 |
| 2007900 | Brown | Closed Lid Insert | 0.8 lb | 16.5" l x 8.0" w x 0.5" h | 0.3 kg | 1 |
| 2007902 | Brown | Bottles/Cans Lid Insert | 0.8 lb | 16.5" l x 8.0" w x 0.5" h | 0.3 kg | 1 |
| 2007903 | Brown | Paper Slot Lid Insert | 0.8 lb | 16.5" l x 8.0" w x 0.5" h | 0.3 kg | 1 |
| 2007904 | Brown | Mixed Recycling Lid Insert | 0.8 lb | 16.5" l x 8.0" w x 0.5" h | 0.3 kg | 1 |

Slim Jim® Recycling Station – Billboard

- Provide better waste stream visibility by selecting a color and waste stream label for your facility needs
- Components snap in place without the use of hardware
- Compatible with Slim Jim® Recycling Station Starter Kit, Slim Jim® Recycling Station lid inserts, and Slim Jim® Recycling Station Waste Stream label kits

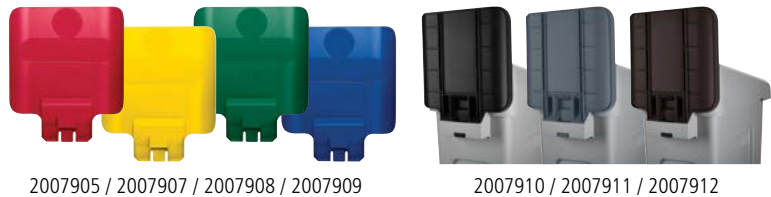

2007905 / 2007907 / 2007908 / 2007909

2007910 / 2007911 / 2007912

| NO. | COLOR | DESCRIPTION | U.S. DIMENSIONS | U.S. SHIP WT/CTN | METRIC SHIP WT/CTN | PACK |
|---------|-----------|-------------|-------------------------------|------------------|--------------------|------|
| 2007905 | Red | Billboard | 1.75" l x 11.75" w x 14.25" h | 0.9 lb | 0.9 lb | 1 |
| 2007907 | Yellow | Billboard | 1.75" l x 11.75" w x 14.25" h | 0.9 lb | 0.9 lb | 1 |
| 2007908 | Green | Billboard | 1.75" l x 11.75" w x 14.25" h | 0.9 lb | 0.9 lb | 1 |
| 2007909 | Blue | Billboard | 1.75" l x 11.75" w x 14.25" h | 0.9 lb | 0.9 lb | 1 |
| 2007910 | Black | Billboard | 1.75" l x 11.75" w x 14.25" h | 0.9 lb | 0.9 lb | 1 |
| 2007911 | Dark Gray | Billboard | 1.75" l x 11.75" w x 14.25" h | 0.9 lb | 0.9 lb | 1 |
| 2007912 | Brown | Billboard | 1.75" l x 11.75" w x 14.25" h | 0.9 lb | 0.9 lb | 1 |

Slim Jim® Recycling Station – Waste Stream Label Kits

- Kit contains 10 different waste stream labels.

| NO. | COLOR | DESCRIPTION | U.S. DIMENSIONS | U.S. SHIP WT/CTN | METRIC DIMENSIONS | METRIC SHIP WT/CTN | PACK |
|---------|-------|-------------------------------------|-----------------|------------------|-------------------|--------------------|------|
| 1977787 | White | Label Kit: English (United States) | 9.5" w x 5.7" h | 0.15 lb | 24.1 cm x 14.5 cm | 0.07 kg | 1 |
| 2007922 | White | Label Kit: French/English (Canada) | 9.5" w x 5.7" h | 0.15 lb | 24.1 cm x 14.5 cm | 0.07 kg | 1 |
| 2007921 | White | Label Kit: English (United Kingdom) | 9.5" w x 5.7" h | 0.15 lb | 24.1 cm x 14.5 cm | 0.07 kg | 1 |
| 2007924 | White | Label Kit: English (Australia) | 9.5" w x 5.7" h | 0.15 lb | 24.1 cm x 14.5 cm | 0.07 kg | 1 |
| 2007923 | White | Label Kit: Spanish | 9.5" w x 5.7" h | 0.15 lb | 24.1 cm x 14.5 cm | 0.07 kg | 1 |
| 2007920 | White | Label Kit: Chinese/English | 9.5" w x 5.7" h | 0.15 lb | 24.1 cm x 14.5 cm | 0.07 kg | 1 |



UTILITY REFUSE
AND RECYCLING

DECORATIVE REFUSE

CLEANING

MATERIAL HANDLING

WASHROOM

FOODSERVICE

ACCESSORIES
& INDEX



**A NEW ANGLE
ON ACCESS**

2026699, 2026721

When ordering products with BOLD color codes, please specify color code after the product number. Refer to the Standard Color Guide at the back of the catalog.

Slim Jim® Under-Counter Containers

A purpose-built solution for space efficient waste disposal under the counter.

- Large angled opening provides 2X more access under the counter than traditional slim containers.
- Integrated venting channels make removing liners 80% easier, improving productivity and reducing the risk of worker injury.
- Commercial-grade construction with high-quality resin material.
- Bag cinches secure liners around the rim of the container and allow for quick, knot-free liner changes.
- Rim and base handles improve grip and control while lifting and emptying full containers.
- Reinforced rim maintains structural integrity to resist crushing.
- Available in 6 colors, Slim Jim® Under-Counter containers fit any space or need.
- Recycling label kit includes seven intuitive waste stream decals, encouraging waste sortation accuracy.
- Recycling label kit includes seven intuitive waste stream decals, encouraging waste sortation accuracy.
- Use Waste Stream Label Kit Version E (1977789) to ensure waste sortation accuracy. See more on page 46.



2026695



2026698



2026699



2026700



2026696



2026697

| NO. | COLOR | DESCRIPTION | U.S. DIMENSIONS | U.S. CAPACITY | U.S. SHIP WT/CTN | METRIC DIMENSIONS | METRIC CAPACITY | METRIC SHIP WT/CTN | CAN LINERS | PACK |
|---------|-------|-----------------------------------|-----------------------------|---------------|------------------|------------------------------|-----------------|--------------------|------------|------|
| 2026695 | Gray | Slim Jim® Under-Counter Container | 22.2" l x 11.2" w x 26.1" h | 13 gal | 30.7 lb | 56.5 cm x 28.4 cm x 66.3 cm | 49 L | 13.9 kg | FG500788 | 4 |
| 2026696 | Black | Slim Jim® Under-Counter Container | 22.2" l x 11.2" w x 26.1" h | 13 gal | 30.7 lb | 56.5 cm x 28.4 cm x 66.3 cm | 49 L | 13.9 kg | FG500788 | 4 |
| 2026697 | Brown | Slim Jim® Under-Counter Container | 22.2" l x 11.2" w x 26.1" h | 13 gal | 30.7 lb | 56.5 cm x 28.4 cm x 66.3 cm | 49 L | 13.9 kg | FG500788 | 4 |
| 2026698 | Beige | Slim Jim® Under-Counter Container | 22.2" l x 11.2" w x 26.1" h | 13 gal | 30.7 lb | 56.5 cm x 28.4 cm x 66.3 cm | 49 L | 13.9 kg | FG500788 | 4 |
| 2026699 | Blue | Slim Jim® Under-Counter Container | 22.2" l x 11.2" w x 26.1" h | 13 gal | 30.7 lb | 56.5 cm x 28.4 cm x 66.3 cm | 49 L | 13.9 kg | FG500788 | 4 |
| 2026700 | Green | Slim Jim® Under-Counter Container | 22.2" l x 11.2" w x 26.1" h | 13 gal | 30.7 lb | 56.5 cm x 28.4 cm x 66.3 cm | 49 L | 13.9 kg | FG500788 | 4 |
| 2026721 | Gray | Slim Jim® Under-Counter Container | 22.1" l x 15.8" w x 30.0" h | 23 gal | 41.7 lb | 56.0 cm x 40.12 cm x 76.2 cm | 87 L | 18.9 kg | FG501188 | 4 |
| 2026722 | Black | Slim Jim® Under-Counter Container | 22.1" l x 15.8" w x 30.0" h | 23 gal | 41.7 lb | 56.0 cm x 40.12 cm x 76.2 cm | 87 L | 18.9 kg | FG501188 | 4 |
| 2026723 | Brown | Slim Jim® Under-Counter Container | 22.1" l x 15.8" w x 30.0" h | 23 gal | 41.7 lb | 56.0 cm x 40.12 cm x 76.2 cm | 87 L | 18.9 kg | FG501188 | 4 |
| 2026724 | Beige | Slim Jim® Under-Counter Container | 22.1" l x 15.8" w x 30.0" h | 23 gal | 41.7 lb | 56.0 cm x 40.12 cm x 76.2 cm | 87 L | 18.9 kg | FG501188 | 4 |
| 2026725 | Blue | Slim Jim® Under-Counter Container | 22.1" l x 15.8" w x 30.0" h | 23 gal | 41.7 lb | 56.0 cm x 40.12 cm x 76.2 cm | 87 L | 18.9 kg | FG501188 | 4 |
| 2026726 | Green | Slim Jim® Under-Counter Container | 22.1" l x 15.8" w x 30.0" h | 23 gal | 41.7 lb | 56.0 cm x 40.12 cm x 76.2 cm | 87 L | 18.9 kg | FG501188 | 4 |

Stainless Steel Dollies

- Collect and transport up to four streams of waste and recyclables with the new stainless steel multi-dollies for Slim Jim® containers
- Constructed from high quality stainless steel material that is easy to clean and won't rust or chip in commercial environments
- Features 3" nonmarking quiet casters that allow for smooth and quiet maneuverability
- Locking feature on casters creates a stable recycling station or collection site
- Slim Jim® Dollies are only compatible with 13G Slim Jim® Under-Counter Containers.



1956192 with 2026699 / 2026700 / 2026696

Resin Trainable Dolly

- Features a side clip-on connection that allows you to train several dollies together for collection and transportation purposes
- Foot pedal release makes disconnecting dollies quick and easy
- Structural foam construction ensures maximum durability in commercial environments
- Slim Jim® Dollies are only compatible with 13G Slim Jim® Under-Counter Containers.



1980602

Dollies

| NO | COLOR | DESCRIPTION | U.S. DIMENSIONS | U.S. CAPACITY | U.S. SHIP WT/CTN | METRIC DIMENSIONS | METRIC CAPACITY | METRIC SHIP WT/CTN | PACK |
|---------|-----------|---|----------------------------|---------------|------------------|-----------------------------|-----------------|--------------------|------|
| 1968468 | Stainless | Slim Jim® Stainless Steel Dolly for Slim Jim® Containers – Single | 20.0" l x 9.3" w x 9.0" h | 100.0 lb | 11.6 lb | 50.8 cm x 23.6 cm x 22.9 cm | 45.4 kg | 5.2 kg | 2 |
| 1956191 | Stainless | Slim Jim® Stainless Steel Dolly for Slim Jim® Containers – Double | 20.0" l x 20.6" w x 9.0" h | 200.0 lb | 9.9 lb | 50.8 cm x 52.3 cm x 22.9 cm | 90.7 kg | 4.5 kg | 1 |
| 1956192 | Stainless | Slim Jim® Stainless Steel Dolly for Slim Jim® Containers – Triple | 20.0" l x 32.5" w x 9.0" h | 300.0 lb | 13.6 lb | 50.8 cm x 82.6 cm x 22.9 cm | 136.1 kg | 6.2 kg | 1 |
| 1980602 | Black | Slim Jim® Resin Trainable Dolly for Slim Jim® Containers | 23.9" l x 14.7" w x 8.4" h | 120.0 lb | 11.9 lb | 60.7 cm x 37.3 cm x 21.3 cm | 54.4 kg | 5.4 kg | 2 |



SlimJim

SLIM JIM® STEP-ON CONTAINERS



QUIET AND CONTROLLED LID CLOSURE

Minimizes noise to enhance guest and patient satisfaction.



SELF-EXTINGUISHING

To ensure fire safety and comply with Factory Mutual (FM) regulations.



MEETS OSHA AND OBRA STANDARDS

For worker and environmental safety.



FITS IN THE TIGHTEST SPACES

Resin Slim Jim® Step-On Containers

Slim profile and small footprint maximize space to fit in the tightest spaces.

- Commercial-grade pedal tested to 300,000 cycles to ensure life in heavy-use environments*
- Robust lid structure features a rigid arch design to prevent warping
- Stainless steel components resist corrosion for long-lasting, smooth operation
- Liner retainer band and cinch easily and securely holds polyliners
- Optional dual-stream rigid liner simplifies sorting, making recycling quick and easy
- Increased foot pedal clearance for easier access and operation
- Quiet and controlled lid closure minimizes noise to enhance guest and patient satisfaction
- Self-extinguishing to ensure fire safety and comply with Factory Manual (FM) regulations
- Meets OSHA and OBRA standards for worker and environmental safety



Resin Step-On Containers

| NO. | COLOR | DESCRIPTION | U.S. DIMENSIONS | U.S. CAPACITY | U.S. SHIP WT/CTN | METRIC DIMENSIONS | METRIC CAPACITY | METRIC SHIP WT/CTN | CAN LINERS | PACK |
|---------|-------|------------------|-----------------------------|---------------|------------------|--------------------------|-----------------|--------------------|------------|------|
| 1883455 | BEIGE | Resin Front Step | 14.8" l x 9.1" w x 15.7" h | 4 gal | 4.70 lb | 377 mm x 230 mm x 399 mm | 15 L | 2.136 kg | | 1 |
| 1883554 | WHITE | Resin Front Step | 14.8" l x 9.1" w x 15.7" h | 4 gal | 4.70 lb | 377 mm x 230 mm x 399 mm | 15 L | 2.136 kg | | 1 |
| 1883563 | RED | Resin Front Step | 14.8" l x 9.1" w x 15.7" h | 4 gal | 4.70 lb | 377 mm x 230 mm x 399 mm | 15 L | 2.136 kg | | 1 |
| 1883599 | GRAY | Resin Front Step | 14.8" l x 9.1" w x 15.7" h | 4 gal | 4.70 lb | 377 mm x 230 mm x 399 mm | 15 L | 2.136 kg | | 1 |
| 1883608 | BLACK | Resin Front Step | 14.8" l x 9.1" w x 15.7" h | 4 gal | 4.70 lb | 377 mm x 230 mm x 399 mm | 15 L | 2.136 kg | | 1 |
| 1883456 | BEIGE | Resin Front Step | 16.7" l x 10.6" w x 21.1" h | 8 gal | 6.0 lb | 425 mm x 271 mm x 536 mm | 30 L | 2.727 kg | | 1 |
| 1883555 | WHITE | Resin Front Step | 16.7" l x 10.6" w x 21.1" h | 8 gal | 6.0 lb | 425 mm x 271 mm x 536 mm | 30 L | 2.727 kg | | 1 |
| 1883564 | RED | Resin Front Step | 16.7" l x 10.6" w x 21.1" h | 8 gal | 6.0 lb | 425 mm x 271 mm x 536 mm | 30 L | 2.727 kg | | 1 |
| 1883600 | GRAY | Resin Front Step | 16.7" l x 10.6" w x 21.1" h | 8 gal | 6.0 lb | 425 mm x 271 mm x 536 mm | 30 L | 2.727 kg | | 1 |
| 1883609 | BLACK | Resin Front Step | 16.7" l x 10.6" w x 21.1" h | 8 gal | 6.0 lb | 425 mm x 271 mm x 536 mm | 30 L | 2.727 kg | | 1 |
| 1883457 | BEIGE | Resin End Step | 19.6" l x 12.3" w x 22.3" h | 8 gal | 10.7 lb | 497 mm x 311 mm x 566 mm | 30 L | 4.864 kg | 1 | 1 |
| 1883565 | RED | Resin End Step | 19.6" l x 12.3" w x 22.3" h | 8 gal | 10.7 lb | 497 mm x 311 mm x 566 mm | 30 L | 4.864 kg | 1 | 1 |
| 1883610 | BLACK | Resin End Step | 19.6" l x 12.3" w x 22.3" h | 8 gal | 10.7 lb | 497 mm x 311 mm x 566 mm | 30 L | 4.864 kg | 1 | 1 |
| 1883458 | BEIGE | Resin Front Step | 17.9" l x 11.5" w x 28.3" h | 13 gal | 8.5 lb | 456 mm x 292 mm x 719 mm | 50 L | 3.864 kg | | 1 |
| 1883557 | WHITE | Resin Front Step | 17.9" l x 11.5" w x 28.3" h | 13 gal | 8.5 lb | 456 mm x 292 mm x 719 mm | 50 L | 3.864 kg | | 1 |
| 1883566 | RED | Resin Front Step | 17.9" l x 11.5" w x 28.3" h | 13 gal | 8.5 lb | 456 mm x 292 mm x 719 mm | 50 L | 3.864 kg | | 1 |
| 1883593 | BLUE | Resin Front Step | 17.9" l x 11.5" w x 28.3" h | 13 gal | 8.5 lb | 456 mm x 292 mm x 719 mm | 50 L | 3.864 kg | | 1 |
| 1883602 | GRAY | Resin Front Step | 17.9" l x 11.5" w x 28.3" h | 13 gal | 8.5 lb | 456 mm x 292 mm x 719 mm | 50 L | 3.864 kg | | 1 |
| 1883611 | BLACK | Resin Front Step | 17.9" l x 11.5" w x 28.3" h | 13 gal | 8.5 lb | 456 mm x 292 mm x 719 mm | 50 L | 3.864 kg | | 1 |
| 1883459 | BEIGE | Resin End Step | 20.8" l x 13.5" w x 28.4" h | 13 gal | 15.6 lb | 527 mm x 343 mm x 721 mm | 50 L | 7.091 kg | 1 | 1 |
| 1883612 | BLACK | Resin End Step | 20.8" l x 13.5" w x 28.4" h | 13 gal | 15.6 lb | 527 mm x 343 mm x 721 mm | 50 L | 7.091 kg | 1 | 1 |
| 1883460 | BEIGE | Resin Front Step | 19.7" l x 12.2" w x 31.6" h | 18 gal | 11.5 lb | 500 mm x 311 mm x 803 mm | 68 L | 5.227 kg | | 1 |
| 1883559 | WHITE | Resin Front Step | 19.7" l x 12.2" w x 31.6" h | 18 gal | 11.5 lb | 500 mm x 311 mm x 803 mm | 68 L | 5.227 kg | | 1 |
| 1883568 | RED | Resin Front Step | 19.7" l x 12.2" w x 31.6" h | 18 gal | 11.5 lb | 500 mm x 311 mm x 803 mm | 68 L | 5.227 kg | | 1 |
| 1883604 | GRAY | Resin Front Step | 19.7" l x 12.2" w x 31.6" h | 18 gal | 11.5 lb | 500 mm x 311 mm x 803 mm | 68 L | 5.227 kg | | 1 |
| 1883613 | BLACK | Resin Front Step | 19.7" l x 12.2" w x 31.6" h | 18 gal | 11.5 lb | 500 mm x 311 mm x 803 mm | 68 L | 5.227 kg | | 1 |
| 1883551 | BEIGE | Resin End Step | 22.1" l x 14.7" w x 30.8" h | 18 gal | 17.1 lb | 562 mm x 373 mm x 781 mm | 68 L | 7.773 kg | 1 | 1 |
| 1883614 | BLACK | Resin End Step | 22.1" l x 14.7" w x 30.8" h | 18 gal | 17.1 lb | 562 mm x 373 mm x 781 mm | 68 L | 7.773 kg | 1 | 1 |
| 1883552 | BEIGE | Resin Front Step | 22.4" l x 13.9" w x 32.5" h | 24 gal | 13.4 lb | 570 mm x 353 mm x 826 mm | 90 L | 6.091 kg | | 1 |
| 1883561 | WHITE | Resin Front Step | 22.4" l x 13.9" w x 32.5" h | 24 gal | 13.4 lb | 570 mm x 353 mm x 826 mm | 90 L | 6.091 kg | | 1 |
| 1883570 | RED | Resin Front Step | 22.4" l x 13.9" w x 32.5" h | 24 gal | 13.4 lb | 570 mm x 353 mm x 826 mm | 90 L | 6.091 kg | | 1 |
| 1883597 | BLUE | Resin Front Step | 22.4" l x 13.9" w x 32.5" h | 24 gal | 13.4 lb | 570 mm x 353 mm x 826 mm | 90 L | 6.091 kg | | 1 |
| 1883606 | GRAY | Resin Front Step | 22.4" l x 13.9" w x 32.5" h | 24 gal | 13.4 lb | 570 mm x 353 mm x 826 mm | 90 L | 6.091 kg | | 1 |
| 1883615 | BLACK | Resin Front Step | 22.4" l x 13.9" w x 32.5" h | 24 gal | 13.4 lb | 570 mm x 353 mm x 826 mm | 90 L | 6.091 kg | | 1 |
| 1883553 | BEIGE | Resin End Step | 25.1" l x 15.9" w x 32.0" h | 24 gal | 21.1 lb | 637 mm x 403 mm x 813 mm | 90 L | 9.591 kg | 1 | 1 |
| 1883616 | BLACK | Resin End Step | 25.1" l x 15.9" w x 32.0" h | 24 gal | 21.1 lb | 637 mm x 403 mm x 813 mm | 90 L | 9.591 kg | 1 | 1 |

*Based on internal testing



Rigid Liner for Resin Slim Jim®

| NO. | COLOR | DESCRIPTION | U.S. DIMENSIONS | U.S. CAPACITY | U.S. SHIP WT/CTN | METRIC DIMENSIONS | METRIC CAPACITY | METRIC SHIP WT/CTN | PACK |
|---------|-------|--|-----------------------------|---------------|------------------|--------------------------|-----------------|--------------------|------|
| 1883617 | | Slim Jim® Rigid Liner for 50L/13G Resin FS | 12.8" l x 7.4" w x 12.8" h | 3 gal | 1.6 lb | 325 mm x 189 mm x 324 mm | 11 L | 2.0 kg | 1 |
| 1883618 | | Slim Jim® Rigid Liner for 30L/8G Resin FS | 14.8" l x 9.1" w x 18.1" h | 6 gal | 2.8 lb | 376 mm x 230 mm x 460 mm | 24 L | 1.2 kg | 1 |
| 1883619 | | Slim Jim® Rigid Liner for 50L/13G Resin FS | 15.8" l x 9.8" w x 18.1" h | 10.5 gal | 4.4 lb | 402 mm x 249 mm x 646 mm | 41 L | 2.0 kg | 1 |
| 1883620 | | Slim Jim® Rigid Liner for 68L/18G Resin FS | 17.8" l x 10.2" w x 28.3" h | 15 gal | 5.4 lb | 451 mm x 259 mm x 718 mm | 57 L | 2.5 kg | 1 |
| 1883621 | | Slim Jim® Rigid Liner for 90L/24G Resin FS | 20.3" l x 11.8" w x 29.5" h | 20 gal | 6.2 lb | 516 mm x 300 mm x 749 mm | 77.5 L | 2.8 kg | 1 |
| 1883623 | | Slim Jim® Rigid Liner for 30L/8G Resin ES | 16.5" l x 8.7" w x 19.5" h | 7.5 gal | 3.2 lb | 419 mm x 221 mm x 495 mm | 30 L | 1.5 kg | 1 |
| 1883624 | | Slim Jim® Rigid Liner for 50L/13G Resin ES | 17.8" l x 9.9" w x 25.5" h | 13 gal | 4.6 lb | 451 mm x 252 mm x 648 mm | 50 L | 2.1 kg | 1 |
| 1883625 | | Slim Jim® Rigid Liner for 68L/18G Resin ES | 19.2" l x 11.1" w x 28.0" h | 17.5 gal | 5.6 lb | 487 mm x 283 mm x 711 mm | 68 L | 2.5 kg | 1 |
| 1883626 | | Slim Jim® Rigid Liner for 90L/24G Resin ES | 22.1" l x 11.8" w x 29.5" h | 23.5 gal | 6.6 lb | 560 mm x 300 mm x 743 mm | 90 L | 3.0 kg | 1 |

Dual Liner for Resin Slim Jim®

| NO. | COLOR | DESCRIPTION | U.S. DIMENSIONS | U.S. CAPACITY | U.S. SHIP WT/CTN | METRIC DIMENSIONS | METRIC CAPACITY | METRIC SHIP WT/CTN | PACK |
|---------|-------|---|-----------------------------|---------------|------------------|--------------------------|-----------------|--------------------|------|
| 1883629 | | Dual Liner for Slim Jim® 90L/24G Resin FS | 20.3" l x 11.8" w x 29.5" h | 18.5 gal | 7.8 lb | 516 mm x 300 mm x 749 mm | 71 L | 3.5 kg | 1 |

Damper Replacement for Resin Slim Jim®

| NO. | COLOR | DESCRIPTION | U.S. DIMENSIONS | U.S. CAPACITY | U.S. SHIP WT/CTN | METRIC DIMENSIONS | METRIC CAPACITY | METRIC SHIP WT/CTN | PACK |
|---------|-------|---|------------------------|---------------|------------------|------------------------|-----------------|--------------------|------|
| 1925497 | | Damper Replacement for 30L/ 8G & 50L/13G ES Resin | 0.5" l x 2" w x 5.5" h | | 0.038 lb | 13 mm x 51 mm x 140 mm | | 0.017 kg | 1 |
| 1925498 | | Damper Replacement for 68L/18G & 90 L/24G ES Resin | 0.5" l x 2" w x 5.5" h | | 0.038 lb | 13 mm x 51 mm x 140 mm | | 0.017 kg | 1 |
| 1925447 | | Damper Replacement for 30L/8G, 50L/13G, 68L/18G, & 90L/24G Resin FS | 0.5" l x 2" w x 5.5" h | | 0.038 lb | 13 mm x 51 mm x 140 mm | | 0.017 kg | 1 |

Resin Step-On Containers

The Rubbermaid Commercial Step-On Container provides sanitary waste management.

- Slow-close, integrated lid damper keeps odors and bacteria from escaping
- Puncture-resistant, all-plastic construction
- Ideal for medical waste containment



FG614500RED

FG614600BEIG

| NO. | COLOR | DESCRIPTION | U.S. DIMENSIONS | U.S. CAPACITY | U.S. SHIP WT/CTN | METRIC DIMENSIONS | METRIC CAPACITY | METRIC SHIP WT/CTN | PACK |
|----------|--------------|--------------------------|-----------------------------|---------------|------------------|-----------------------------|-----------------|--------------------|------|
| FG614300 | BEIGE | 8G Resin Step-On | 15.8" l x 16.3" w x 17.1" h | 8 gal | 6.8 lb | 40.1 cm x 41.4 cm x 43.4 cm | 30 L | 3.1 kg | 1 |
| 2089825 | BLACK | 8G Resin Step-On | 15.8" l x 16.3" w x 17.1" h | 8 gal | 6.8 lb | 40.1 cm x 41.4 cm x 43.4 cm | 30 L | 3.1 kg | 1 |
| FG614300 | RED | 8G Resin Step-On | 15.8" l x 16.3" w x 17.1" h | 8 gal | 6.8 lb | 40.1 cm x 41.4 cm x 43.4 cm | 30 L | 3.1 kg | 1 |
| FG614300 | WHITE | 8G Resin Step-On | 15.8" l x 16.3" w x 17.1" h | 8 gal | 6.8 lb | 40.1 cm x 41.4 cm x 43.4 cm | 30 L | 3.1 kg | 1 |
| FG614400 | BEIGE | 12G Resin Step-On | 15.0" l x 16.3" x 23.6" h | 12 gal | 9.0 lb | 38.1 cm x 41.4 cm x 59.9 cm | 45 L | 4.1 kg | 1 |
| 2089820 | BLACK | 12G Resin Step-On | 15.0" l x 16.3" x 23.6" h | 12 gal | 9.0 lb | 38.1 cm x 41.4 cm x 59.9 cm | 45 L | 4.1 kg | 1 |
| FG614400 | RED | 12G Resin Step-On | 15.0" l x 16.3" x 23.6" h | 12 gal | 9.0 lb | 38.1 cm x 41.4 cm x 59.9 cm | 45 L | 4.1 kg | 1 |
| FG614400 | WHITE | 12G Resin Step-On | 15.0" l x 16.3" x 23.6" h | 12 gal | 9.0 lb | 38.1 cm x 41.4 cm x 59.9 cm | 45 L | 4.1 kg | 1 |
| FG614500 | BEIGE | 18G Resin Step-On | 14.8" l x 19.8" w x 26.5" h | 18 gal | 12.4 lb | 37.6 cm x 50.3 cm x 67.3 cm | 68 L | 5.6 kg | 1 |
| 2089824 | BLACK | 18G Resin Step-On | 14.8" l x 19.8" w x 26.5" h | 18 gal | 12.4 lb | 37.6 cm x 50.3 cm x 67.3 cm | 68 L | 5.6 kg | 1 |
| FG614500 | RED | 18G Resin Step-On | 14.8" l x 19.8" w x 26.5" h | 18 gal | 12.4 lb | 37.6 cm x 50.3 cm x 67.3 cm | 68 L | 5.6 kg | 1 |
| FG614500 | WHITE | 18G Resin Step-On | 14.8" l x 19.8" w x 26.5" h | 18 gal | 12.4 lb | 37.6 cm x 50.3 cm x 67.3 cm | 68 L | 5.6 kg | 1 |
| FG614600 | BEIGE | 23G Resin Mobile Step-On | 16.5" x 19.8" w x 32.6" h | 23 gal | 16.2 lb | 41.9 cm x 50.3 cm x 82.8 cm | 87 L | 7.3 kg | 1 |
| 2089821 | BLACK | 23G Resin Step-On | 16.5" x 19.8" w x 32.6" h | 23 gal | 16.2 lb | 41.9 cm x 50.3 cm x 82.8 cm | 87 L | 7.3 kg | 1 |
| FG614600 | RED | 23G Resin Mobile Step-On | 16.5" x 19.8" w x 32.6" h | 23 gal | 16.2 lb | 41.9 cm x 50.3 cm x 82.8 cm | 87 L | 7.3 kg | 1 |
| FG614600 | WHITE | 23G Resin Mobile Step-On | 16.5" x 19.8" w x 32.6" h | 23 gal | 16.2 lb | 41.9 cm x 50.3 cm x 82.8 cm | 87 L | 7.3 kg | 1 |

UTILITY REFUSE AND RECYCLING

DECORATIVE REFUSE

CLEANING

MATERIAL HANDLING

WASHROOM

FOODSERVICE

ACCESSORIES & INDEX

Untouchable® Containers and Tops

Versatile and tough for indoor or outdoor applications.

Available in round, half-round, and square shapes.

- Durable and crack-resistant, even under tough indoor/outdoor conditions
 - Post-consumer recycled resin (PCR) content meets EPA guidelines
 - Use Waste Steam Label Kit Version A (1977785) to ensure waste sortation accuracy.
- See more on page 44

Untouchable® Recycling Containers

Stationary containers provide convenient central collection sites for multiple work stations or areas.

- Durable and crack-resistant, even under tough indoor/outdoor conditions
 - Post-consumer recycled resin (PCR) content meets EPA guidelines
 - Recycling options available
 - All containers come standard with the universal recycle symbol imprint
 - Use Waste Steam Label Kit Version A (1977785) to ensure waste sortation accuracy.
- See more on page 44



FG356988



FG268988



Integrated pull-through hole and can liner cinch.



ADA COMPLIANT



FG356973 / 1788374
Single-Stream



FG356973 / FG269000
Paper



FG356973 / FG269100
Bottle and Can

| NO. | COLOR | DESCRIPTION | U.S. DIMENSIONS | U.S. CAPACITY | U.S. SHIP WT/CTN | METRIC DIMENSIONS | METRIC CAPACITY | METRIC SHIP WT/CTN | CAN LINERS | PACK |
|-----------|-----------------|--|-----------------------------|---------------|------------------|-----------------------------|-----------------|--------------------|----------------------|------|
| FG294700 | GRAY | Untouchable® Round Container | 15.8" dia x 18.8" h | 11 gal | 15.9 lb | 40.0 cm dia x 47.6 cm | 42.0 L | 7.2 kg | 5003-88 ^a | 6 |
| FG352000 | GRAY, BEIG | Untouchable® Half Round Container | 12" l x 21" w x 28.7" h | 21 gal | 29.5 lb | 30.4 cm x 53.3 cm x 72.8 cm | 13.4 kg | 5.2 kg | 5005-88 ^a | 4 |
| FG354600 | GRAY | Untouchable® Round Container | 15.75" dia x 30.1" h | 22 gal | 27.6 lb | 40 cm dia x 76.5 cm | 83.3 L | 12.5 kg | 5004-88 ^a | 4 |
| FG356988 | GRAY, BEIG, BLA | Untouchable® Round Container | 16.5" l x 15.5" w x 30.9" h | 23 gal | 21.1 lb | 41.9 cm x 39.4 cm x 78.5 cm | 87.1 L | 9.6 kg | 5004-88 ^a | 4 |
| FG395800 | GRAY, BEIG | Untouchable® Square Container (liner for FG917100/FG917300/FG396500) | 19.5" sq x 27.6" h | 35 gal | 39.4 lb | 49.5 cm sq x 70.2 cm | 132.5 L | 17.9 kg | 5008-88 ^a | 4 |
| FG395900 | GRAY, BEIG | Untouchable® Square Container (liner for FG917500/FG917600) | 19.5" sq x 34.3" h | 50 gal | 53.3 lb | 49.5 cm sq x 87 cm | 189.3 L | 24.1 kg | 5008-88 ^a | 4 |
| FG266400 | GRAY, BEIG | Untouchable® Square Swing Top for FG395800, FG395900 Containers | 20.13" sq x 6.3" h | | 22.7 lb | 51.1 cm sq x 15.9 cm | | 10.3 kg | | 4 |
| FG267200 | BEIG | Untouchable® Round Swing Top for FG294700, FG354600 Containers | 16.1" dia x 5.0" h | | 8.5 lb | 40.9 cm x 12.7 cm | | 3.9 kg | | 4 |
| FG268988 | GRAY, BEIG, BLA | Untouchable® Swing Top for FG356907, FG356988 Containers | 16.0" sq x 4.0" h | | 13.8 lb | 40.6 cm sq x 10.2 cm | | 6.3 kg | | 4 |
| FG354800* | GRAY | Untouchable® Round Funnel Top for FG294700, FG354600 Containers | 16.3" dia x 4.0" h | | 5.5 lb | 41.4 cm x 10.2 cm | | 2.5 kg | | 4 |
| FG362000 | BLA | Untouchable® Half-Round Lid, with Swing Door for FG352000 Container | 21.1" sq x 9.5" h | | 11.4 lb | 53.5 cm sq x 24.1 cm | | 5.1 kg | | 4 |
| FG356973 | BLUE | Untouchable® Square Recycling Container | 16.5" l x 15.5" w x 30.9" h | 23 gal | 21.2 lb | 41.9 cm x 39.4 cm x 78.5 cm | 87.1 L | 9.6 kg | 5005-88 ^a | 4 |
| FG395873 | BLUE | Square Recycling Container | 19.5" sq x 27.6" h | 35 gal | 39.4 lb | 49.5 cm sq x 70.2 cm | 132.5 L | 17.9 kg | 5005-88 ^a | 4 |
| FG395973 | BLUE | Square Recycling Container | 19.5" sq x 34.3" h | 50 gal | 53.9 lb | 49.5 cm sq x 87 cm | 189.3 L | 24.4 kg | 5005-88 ^a | 4 |
| FG352073 | BLUE | Half-Round Recycling Container | 21.0" l x 12.0" w x 28.6" h | 21 gal | 28.6 lb | 53.3 cm x 30.5 cm x 72.6 cm | 79.5 L | 13.0 kg | 5005-88 ^a | 4 |

Tops and Label Kit

| NO. | COLOR | DESCRIPTION | U.S. DIMENSIONS | U.S. SHIP WT/CTN | METRIC DIMENSIONS | METRIC SHIP WT/CTN | PACK |
|----------|-------|---|-------------------|------------------|----------------------|--------------------|------|
| FG279100 | DBLUE | Untouchable® Bottle and Can Recycling Top for FG395873, FG395973 Containers | 20.1" sq x 6.3" h | 11.9 lb | 51.1 cm sq x 15.9 cm | 5.4 kg | 4 |
| FG279400 | DBLUE | Untouchable® Paper Recycling Top for FG395873, FG395973 Containers | 20.1" sq x 6.3" h | 14.5 lb | 51.1 cm sq x 15.9 cm | 6.6 kg | 4 |
| 1788374 | BLUE | Untouchable® Single-Stream Recycling Top for FG356988 Container | 16.0" sq x 3.2" h | 4.7 lb | 40.6 cm sq x 8.1 cm | 2.1 kg | 4 |
| 1788375 | GREEN | Untouchable® Single-Stream Recycling Top for FG356988 Container | 16.0" sq x 3.2" h | 4.7 lb | 40.6 cm sq x 8.1 cm | 2.1 kg | 4 |
| FG269000 | BLUE | Untouchable® Paper Recycling Top for FG356988 Container | 16.0" sq x 3.2" h | 4.4 lb | 40.6 cm sq x 8.1 cm | 2.0 kg | 4 |
| FG269100 | BLUE | Untouchable® Bottle and Can Recycling Top for FG356988 Container | 16.0" sq x 3.2" h | 4.4 lb | 40.6 cm sq x 8.1 cm | 2.0 kg | 4 |



Deskside Waste and Recycling Baskets and Tops

Space-efficient, economical, and an easy and effective way to recycle.

- All-plastic construction won't chip, rust, or dent. Rolled rims add strength, and are easy to clean
- Fits under standard-height desk even when swing top is fully extended
- Recycling options available
- Use Waste Stream Label Kit Version A (1977785) to ensure waste sortation accuracy. See more on page 44.



Rolled rim adds strength to the already durable Rubbermaid design.

Innovative rim tabs prevent jamming when nested.



Rubbermaid's reliable, puncture-resistant, all-plastic construction means they won't rust or chip and will stand up to years of use.

Rounded corners and smooth contours make for easy cleaning and emptying.

FG295600

FG295673 with
FG295073 Side Bin

Side bins create a compact deskside recycling center.

- Add side bins to turn a regular wastebasket into a convenient recycling station
- Customize with different colors for all your recycling sortation needs
- Designed to fit under any standard desk or counter while handling all the waste in a day's work

Deskside Wastebaskets

| NO. | COLOR | DESCRIPTION | U.S. DIMENSIONS | U.S. CAPACITY | U.S. SHIP WT/CTN | METRIC DIMENSIONS | METRIC CAPACITY | METRIC SHIP WT/CTN | CAN LINERS | PACK |
|----------|------------------------|---------------------|-----------------------------|---------------|------------------|-----------------------------|-----------------|--------------------|------------|------|
| FG295500 | GRAY, BEIG, BLA | Wastebasket, Small | 11.4" l x 8.3" w x 12.13" h | 13% qt | 14.3 lb | 28.9 cm x 21 cm x 30.8 cm | 12.9 L | 6.5 kg | 5002-88 | 12 |
| 2044159 | WHITE | Wastebasket, Small | 11.4" l x 8.3" w x 12.13" h | 13% qt | 14.3 lb | 28.9 cm x 21 cm x 30.8 cm | 12.9 L | 6.5 kg | 5002-88 | 12 |
| FG295600 | GRAY, BEIG, BLA | Wastebasket, Medium | 14.4" l x 10.3" w x 15.0" h | 28% qt | 20.7 lb | 36.5 cm x 26 cm x 38.1 cm | 26.6 L | 9.4 kg | 5002-88 | 12 |
| 2044160 | WHITE | Wastebasket, Medium | 14.4" l x 10.3" w x 15.0" h | 28% qt | 20.7 lb | 36.5 cm x 26 cm x 38.1 cm | 26.6 L | 9.4 kg | 5002-88 | 12 |
| 2031824 | BLUE | Wastebasket, Medium | 14.4" l x 10.3" w x 15.0" h | 28% qt | 20.7 lb | 36.5 cm x 26 cm x 38.1 cm | 26.6 L | 9.4 kg | 5002-88 | 12 |
| 2031812 | GREEN | Wastebasket, Medium | 14.4" l x 10.3" w x 15.0" h | 28% qt | 20.7 lb | 36.5 cm x 26 cm x 38.1 cm | 26.6 L | 9.4 kg | 5002-88 | 12 |
| FG295700 | GRAY, BEIG, BLA | Wastebasket, Large | 11.3" l x 15.3" w x 20" h | 41% qt | 27.3 lb | 27.9 cm x 39.4 cm x 52.7 cm | 12.4 kg | 12.4 kg | 5003-88 | 12 |

Deskside Recycling Containers

| NO. | COLOR | DESCRIPTION | U.S. DIMENSIONS | U.S. CAPACITY | U.S. SHIP WT/CTN | METRIC DIMENSIONS | METRIC CAPACITY | METRIC SHIP WT/CTN | CAN LINERS | PACK |
|----------|------------------------|--|-----------------------------|---------------|------------------|-----------------------------|-----------------|--------------------|------------|------|
| FG295073 | BLUE, GRAY, BLA | Side Bin Recycling Center | 10.6" l x 7.3" w x 11.7" h | 4% qt | 9.0 lb | 26.9 cm x 18.5 cm x 29.7 cm | 4.50 L | 4.1 kg | | 12 |
| FG295573 | BLUE | Deskside Recycling Container, Small with Universal Recycle Symbol | 11.4" l x 8.3" w x 12.1" h | 13% qt | 14.3 lb | 29.0 cm x 21.0 cm x 30.8 cm | 12.9 L | 6.5 kg | 5002-88 | 12 |
| FG295606 | GRN | Deskside Recycling Container, Medium with Universal Recycle Symbol | 14.5" l x 10.5" w x 15.0" h | 28% qt | 21.7 lb | 36.8 cm x 26.7 cm x 38.1 cm | 26.6 L | 9.8 kg | 5002-88 | 12 |
| FG295673 | BLUE | Deskside Recycling Container, Medium with Universal Recycle Symbol | 14.5" l x 10.5" w x 15.0" h | 28% qt | 21.7 lb | 36.8 cm x 26.7 cm x 38.1 cm | 26.6 L | 9.8 kg | 5002-88 | 12 |
| FG295773 | BLUE | Deskside Recycling Container, Large with Universal Recycle Symbol | 15.3" l x 11.3" w x 20.0" h | 41% qt | 28.3 lb | 38.7 cm x 28.6 cm x 50.8 cm | 39 L | 12.8 kg | 5003-88 | 12 |

Untouchable® Wastebasket Tops and Combos

| NO. | COLOR | DESCRIPTION | U.S. DIMENSIONS | U.S. CAPACITY | U.S. SHIP WT/CTN | METRIC DIMENSIONS | METRIC CAPACITY | METRIC SHIP WT/CTN | CAN LINERS | PACK |
|----------|-----------|---|----------------------------|---------------|------------------|-----------------------------|-----------------|--------------------|------------|------|
| FG306600 | BLA, BEIG | Untouchable® Swing Top for FG295600 Container | 15.0" l x 10.9" w x 6.0" h | | 6.6 lb | 38.1 cm x 27.6 cm x 15.2 cm | | 2.9 kg | | 6 |
| 1779742 | GRAY | Untouchable® Swing Top for FG295600 Container | 15.0" l x 10.9" w x 6.0" h | | 6.6 lb | 38.1 cm x 27.6 cm x 15.2 cm | | 2.9 kg | | 6 |
| FG306700 | BLA | Untouchable® Swing Top for FG295700 Container | 16.0" l x 11.6" w x 7.9" h | | 8.5 lb | 40.6 cm x 29.5 cm x 20.0 cm | | 3.9 kg | | 6 |
| 1829407 | BLUE | Untouchable® Swing Top for FG295700 Container | 16.0" l x 11.6" w x 7.9" h | | 8.5 lb | 40.6 cm x 29.5 cm x 20.0 cm | | 3.9 kg | | 6 |
| 1829409 | GRAY | Untouchable® Swing Top for FG295700 Container | 16.0" l x 11.6" w x 7.9" h | | 8.5 lb | 40.6 cm x 29.5 cm x 20.0 cm | | 3.9 kg | | 6 |

^ Not for sale in California.

Hide-A-Bag

Award-winning design conceals can liner for a neat appearance.

- Fire-safe steel construction
- Noncorrosive vinyl base ring protects floors



| NO. | COLOR | DESCRIPTION | CAPACITY (GAL) | CAPACITY (LITERS) | U.S. DIMENSIONS | U.S. SHIP WT/CTN | METRIC DIMENSIONS | METRIC SHIP WT/CTN | CARTON QUANTITY |
|------------|-------|--|----------------|-------------------|--------------------|------------------|-----------------------|--------------------|-----------------|
| Ⓢ FGWHB14 | SS | Hide-a-Bag Open-Top Wastebasket, Stainless | 3.5 | 13.2 | 9.5" dia x 12.5" h | 7.0 lb | 24.1 cm dia x 31.8 cm | 3.2 kg | |
| Ⓢ FGWHB14E | BK | Hide-a-Bag Open-Top Wastebasket, Black | 3.5 | 13.2 | 9.5" dia x 12.5" h | 8.0 lb | 24.1 cm dia x 31.8 cm | 3.6 kg | |

Black (BK), Stainless Steel (SS)

Concept Collection™

Designer solutions for desk-side disposal.

- "No snag" curled rim protects clothing
- Baked-on epoxy finish
- Solid steel base
- Vinyl base ring protects floors



FGWB29RSS



FGWMB30RBK



FGWMB20BK

| NO. | COLOR | DESCRIPTION | CAPACITY (GAL) | CAPACITY (LITERS) | U.S. DIMENSIONS | U.S. SHIP WT/CTN | METRIC DIMENSIONS | METRIC SHIP WT/CTN | CARTON QUANTITY |
|----------|---------|--|----------------|-------------------|-----------------------------|------------------|-----------------------------|--------------------|-----------------|
| FGWB29R | SS | Concept Collection™ Open-Top Wastebasket | 7.25 | 27.4 | 24.0" l x 15.5" w x 11.0" h | 14.6 lb | 60.9 cm x 39.3 cm x 27.9 cm | 6.6 kg | 3 |
| FGWMB20 | BK, SLV | Concept Collection™ Open-Top Wastebasket | 5 | 18.9 | 11.5" dia x 14" h | 10.2 lb | 29.2 cm dia x 35.6 cm | 4.6 kg | 6 |
| FGWMB30R | BK | Concept Collection™ Open-Top Wastebasket | 7.5 | 28.4 | 16.0" l x 8.5" w x 14.0" h | 7.0 lb | 40.6 cm x 21.6 cm x 35.6 cm | 3.2 kg | 3 |

Black (BK), Stainless Steel (SS)

Profile Containers

Attractive design suits many decors.

- Wall mounting keeps the container out of pedestrian traffic and allows for floor cleaning
- Spring-loaded swing door helps control odor and hides trash from public view
- Comes with complete hardware and instructions for wall mounting
- Factory Mutual (FM) approved for fire safety when wall mounted; ideal for hallways and other uncontrolled public areas
- Slim design limits intrusion into corridors, washrooms, kitchens, and other limited space areas



ADA COMPLIANT



FG782200



FG782200

| NO. | COLOR | DESCRIPTION | U.S. DIMENSIONS | U.S. CAPACITY | U.S. SHIP WT/CTN | METRIC DIMENSIONS | METRIC CAPACITY | METRIC SHIP WT/CTN | CAN LINERS | PACK |
|----------|------------------|----------------------------------|-----------------------------|---------------|------------------|-----------------------------|-----------------|--------------------|------------|------|
| FG782200 | BRN, BEIG | Slim Jim® Wall-Mounted Container | 19.5" l x 11.9" w x 32.6" h | 15 gal | 11.6 lb | 49.5 cm x 30.2 cm x 82.9 cm | 56.8 L | 5.3 kg | 5005-88* | 1 |

*Not for sale in California.

Fire-Resistant Wastebaskets

Great for use in areas requiring increased levels of fire protection, such as hospitals, schools, and hotels.

- UL® Classification ensures fire safety
- Textured finish for enhanced aesthetics



CSFM

FG254400



FG254100

FG254000

FG254300

| NO. | COLOR | DESCRIPTION | U.S. DIMENSIONS | U.S. CAPACITY | U.S. SHIP WT/CTN | METRIC DIMENSIONS | METRIC CAPACITY | METRIC SHIP WT/CTN | CAN LINERS | PACK |
|----------|------------------------|----------------------------|-----------------------------|---------------|------------------|-----------------------------|-----------------|--------------------|------------|------|
| FG254000 | BEIG | Fire-Resistant Wastebasket | 8.9" l x 6.4" w x 10.3" h | 7 qt | 10.2 lb | 22.6 cm x 16.2 cm x 26.2 cm | 6.6 L | 4.6 kg | | 6 |
| FG254100 | GRAY, BLA, BEIG | Fire-Resistant Wastebasket | 11.1" l x 8.3" w x 12.3" h | 14 qt | 19.6 lb | 28.3 cm x 21 cm x 31.1 cm | 13.2 L | 8.9 kg | | 6 |
| FG254300 | GRAY, BLA, BEIG | Fire-Resistant Wastebasket | 14.5" l x 10.5" w x 15.3" h | 28 qt | 30.4 lb | 36.8 cm x 26.7 cm x 38.9 cm | 26.5 L | 13.8 kg | | 6 |
| FG254400 | BEIG | Fire-Resistant Wastebasket | 15.0" l x 11.3" w x 20.0" h | 40 qt | 29.6 lb | 38.1 cm x 28.6 cm x 50.8 cm | 37.9 L | 13.4 kg | | 4 |

For Other Fire-Rated Containers See:



Profile Wall-Mounted



Step-On Containers



Steel Containers



Plaza® Containers



Ranger® Containers



Smoking Management Containers

When ordering products with **BOLD** color codes, please specify color code after the product number. Refer to the Standard Color Guide at the back of the catalog.

Recycling Boxes

The Rubbermaid Commercial Recycling Bin is made of post-consumer recycled resin for commercial recycling use.

- Built-in handles for easier lifting and carrying
- Designed to stack or nest for increased productivity
- Commercial-grade construction to withstand years of indoor and outdoor use



FG571873BLUE



FG571873GRN

| NO. | COLOR | DESCRIPTION | U.S. DIMENSIONS | U.S. CAPACITY | U.S. SHIP WT/CTN | METRIC DIMENSIONS | METRIC CAPACITY | METRIC SHIP WT/CTN | CAN LINERS | PACK |
|----------|-----------|-------------------------|------------------------------|---------------|------------------|-----------------------------|-----------------|--------------------|------------|------|
| FG571473 | BLUE, GRN | 14-Gallon Recycling Box | 20.75" l x 16" w x 14.75" h | 14 gal | 25.23 lb | 52.7 cm x 40.6 cm x 37.5 cm | 53 L | 11.4 kg | | 6 |
| FG571873 | BLUE, GRN | 18-Gallon Recycling Box | 25.75" l x 16.5" w x 26.5" h | 18 gal | 30.36 lb | 65.4 cm x 41.9 cm x 67.3 cm | 68.1 L | 13.8 kg | | 6 |

Glutton® Recycling Stations

High-capacity, all-in-one centralized solutions for efficient waste sortation.

- 2-stream and 4-stream options are available



Two-Stream Glutton® Recycling Station
1792340



Four-Stream Glutton® Recycling Station
1792372

Flexible Labeling

Includes separate color-coded symbol and word labels for customizing the Recycling Station based on facility needs.

Multiple Stream Sortation

Use any combination of the restrictive-opening tops to sort up to four separate waste streams. Tops snap securely into lid.

High-Capacity Collection

Improves productivity by reducing the frequency of trips to empty the filled containers. Holds up to 92 gallons of waste.



Permanent Hot-Stamped Logo

Durable Construction
Features traditional Rubbermaid Commercial Products' strength and durability in easy-to-clean, impact-resistant post-consumer plastic.

| NO. | COLOR | DESCRIPTION | U.S. DIMENSIONS | U.S. CAPACITY | U.S. SHIP WT/CTN | METRIC DIMENSIONS | METRIC CAPACITY | METRIC SHIP WT/CTN | PACK |
|----------|-------|--|------------------------------|---------------|------------------|-----------------------------|-----------------|--------------------|------|
| 1792339 | BLUE | Two-Stream Glutton® Recycling Station | 26.8" l x 23.6" w x 35.5" h | 46 gal | 41 lb | 68.1 cm x 59.9 cm x 90.2 cm | 174.1 L | 18.6 kg | 1 |
| 1792340 | GREEN | Two-Stream Glutton® Recycling Station | 26.8" l x 23.6" w x 35.5" h | 46 gal | 41 lb | 68.1 cm x 59.9 cm x 90.2 cm | 174.1 L | 18.6 kg | 1 |
| 1792371 | BEIGE | Two-Stream Glutton® Recycling Station | 26.8" l x 23.6" w x 35.5" h | 46 gal | 41 lb | 68.1 cm x 59.9 cm x 90.2 cm | 174.1 L | 18.6 kg | 1 |
| FG256L00 | DBLUE | Glutton® Bottle and Can Recycling Top for FG256B73 Container | 26.63" l x 23.0" w x 13.0" h | N/A | 14.2 lb | 67.6 cm x 58.4 cm x 33 cm | N/A | 7.5 kg | 1 |
| FG256B73 | BLUE | Glutton® Recycling Container | 25.5" l x 22.8" w x 31.1" h | 56 gal | 66.5 lb | 64.8 cm x 57.8 cm x 79.1 cm | 212 L | 30.2 kg | 4 |
| 1792372 | BLUE | Four-Stream Glutton® Recycling Station | 53.0" l x 24.0" w x 35.5" h | 92 gal | 67.3 lb | 134.6 cm x 61 cm x 90.2 cm | 348.3 L | 30.5 kg | 1 |
| 1792373 | GREEN | Four-Stream Glutton® Recycling Station | 53.0" l x 24.0" w x 35.5" h | 92 gal | 67.3 lb | 134.6 cm x 61 cm x 90.2 cm | 348.3 L | 30.5 kg | 1 |
| 1792374 | BEIGE | Four-Stream Glutton® Recycling Station | 53.0" l x 24.0" w x 35.5" h | 92 gal | 67.3 lb | 134.6 cm x 61 cm x 90.2 cm | 348.3 L | 30.5 kg | 1 |
| 1792975 | | Waste Stream Label Kit | 8.2" w x 6.8" h | N/A | 1.8 lb | 20.8 cm x 17.2 cm | N/A | 0.8 kg | 8 |



Steel Wastebasket Open Tops

Fire-safe, puncture-resistant steel wastebaskets

- UL® Classification ensures fire safety; the raised bottom prevents heat transfer in case of fire



Steel Wastebasket Dome Tops

Fire-safe, puncture-resistant steel wastebaskets

- UL® Classification ensures fire safety; the raised bottom prevents heat transfer in case of fire



FGBBT1529GR
(Dome Top)



FGWB2029GR



FGWB96RBK



FGWB26BK

Steel Wastebasket Open Tops

| NO. | COLOR | DESCRIPTION | U.S. DIMENSIONS | U.S. CAPACITY | U.S. SHIP WT/CTN | METRIC DIMENSIONS | METRIC CAPACITY | METRIC SHIP WT/CTN | CAN LINERS | PACK |
|------------------------|-------------------|----------------------------|---------------------|---------------|------------------|-----------------------|-----------------|--------------------|------------|------|
| FGWB26 [†] | AL, BK, GR | Steel Wastebasket Open Top | 13.5" dia x 14.5" h | 26 qt | 31.6 lb | 34.3 cm dia x 36.8 cm | 98.4 L | 14.3 kg | | 6 |
| FGWB30R [*] | AL, GR | Steel Wastebasket Open Top | 17.0" w x 15.0" h | 30 qt | 17.0 lb | 43.2 cm x 38.1 cm | 113.6 L | 7.7 kg | | 3 |
| FGWB2029 ^{**} | GR | Steel Wastebasket Open Top | 16.0" dia x 29.0" h | 80 qt | 28.0 lb | 40.6 cm dia x 73.7 cm | 302.8 L | 12.7 kg | | 3 |
| FGWB96R | AL, BK | Steel Wastebasket Open Top | 21.0" w x 30.0" h | 96 qt | 37.0 lb | 53.3 cm x 76.2 cm | 363.4 L | 16.8 kg | | 3 |

Almond (AL), Black (BK), Gray (GR) †UL-Classified ‡FM-approved *UL-Listed when used with FGBBT1529

Steel Wastebasket Dome Top

| NO. | COLOR | DESCRIPTION | U.S. DIMENSIONS | U.S. CAPACITY | U.S. SHIP WT/CTN | METRIC DIMENSIONS | METRIC CAPACITY | METRIC SHIP WT/CTN | CAN LINERS | PACK |
|------------------------|---------------|---|--------------------|---------------|------------------|-------------------|-----------------|--------------------|------------|------|
| FGBBT1529 [*] | BK, GR | Steel Wastebasket Dome Top for FGWB2029 | 16.2" dia x 9.4" h | N/A | 6.0 lb | 41.3 cm x 23.8 cm | N/A | 2.7 kg | | 1 |

Black (BK), Gray (GR) †UL-Listed *FM-approved

Can Liners

High-quality can liners for a variety of applications.

- Strong "star seal" bottom eliminates gaps along the seal where leaks can occur
- Easily conforms to the shape of the container
- Distributes refuse weight evenly inside the liner

High-Density Coreless Roll

Great for paper and nonsharp objects under moderate transport conditions.

- Excellent resistance to puncture and light resistance to tearing
- Greater load capacity than linear low-density can liners
- Continuous coreless roll makes dispensing easy and reduces theft

Linear Low-Density

Recommended for sharper objects under tougher transport conditions.

- Excellent resistance to puncture and tearing
- Good load capacity
- Topside dual-dispensing carton allows for top or side dispensing



Star Seal Bottom
Strong star seal bottom is designed without gussets, where leaks are prone to occur.



Buy the right-sized can liner for your Rubbermaid Commercial Products containers!

APPLICATIONS

| HIGH-DENSITY | LINEAR LOW-DENSITY |
|----------------|--------------------|
| Restaurants | Janitorial |
| Office paper | Housekeeping |
| Construction | Everyday use |
| Parks/stadiums | Schools |

High-Density Coreless Roll Can Liners

| NO. | COLOR | DESCRIPTION | U.S. DIMENSIONS | U.S. SIZE | U.S. CAPACITY | U.S. SHIP WT/CTN | METRIC DIMENSIONS | METRIC SIZE | METRIC CAPACITY | METRIC SHIP WT/CTN | U.S./METRIC GAUGE | PACK |
|----------|-------|---------------------------------------|-------------------|-----------|---------------|------------------|---------------------|-------------|-----------------|--------------------|-------------------|-----------|
| FG507900 | CLR | High-Density Coreless Roll Can Liners | 49.0" l x 43.0" w | 86" cir | 45–56 gal | 18.6 lb | 124.5 cm x 109.2 cm | 218.4 cm | 170–211 L | 8.4 kg | .63 mil/16 µm | 1/200 pcs |

Materials comply with USDA and FDA regulations for food contact.

Linear Low-Density Can Liners

| NO. | COLOR | FITS (ALL PRODUCT NUMBERS BEGIN WITH "FG") | U.S. DIMENSIONS | U.S. SIZE | U.S. CAPACITY | U.S. SHIP WT/CTN | METRIC DIMENSIONS | METRIC SIZE | METRIC CAPACITY | METRIC SHIP WT/CTN | U.S./METRIC GAUGE | PACK |
|-----------------------|-----------|--|--------------------|-----------|---------------|------------------|---------------------|-------------|-----------------|--------------------|-------------------|------------|
| FG500288 ^a | CLR | 295200, 295500, 295600, 614200 | 24.0" l x 21.5" w | 43" cir | 6 gal | 29.6 lb | 61.0 cm x 54.6 cm | 109.2 cm | 22.7 L | 13.4 kg | 0.8 mil/20 µm | 1/1000 pcs |
| FG500388 ^a | CLR | 261000, 294700, 295700, 307120 | 30.0" l x 23.75" w | 47½" cir | 11 gal | 20.3 lb | 76.2 cm x 60.3 cm | 120.6 cm | 41.6 L | 9.2 kg | 0.8 mil/20 µm | 1/500 pcs |
| FG500488 ^a | GRAY | 354600, 816088, 818488, 818588, 614300, 614400, 617700 | 38.8" l x 24.5" w | 49" cir | 22 gal | 20.2 lb | 98.4 cm x 62.2 cm | 124.4 cm | 83.3 L | 9.2 kg | 1.0 mil/25 µm | 1/300 pcs |
| FG500588 ^a | GRAY | 352000, 356800, 356900, 782200, 782300, 817088, 818088, 818288, 818588 | 39.0" l x 27.5" w | 55" cir | 23 gal | 22.7 lb | 99.1 cm x 69.9 cm | 139.7 cm | 87.1 L | 10.3 kg | 1.0 mil/25 µm | 1/300 pcs |
| FG500688 ^a | GRAY | 262000, 614687 | 34.0" l x 30.0" w | 60" cir | 20 gal | 26.3 lb | 86.4 cm x 76.2 cm | 152.4 cm | 75.7 L | 11.9 kg | 1.2 mil/30 µm | 1/300 pcs |
| FG500788 ^a | GRAY | 263200, 263400, 263246, 263256 | 39.0" l x 34.0" w | 68" cir | 32 gal | 33.7 lb | 99.1 cm x 86.4 cm | 172.7 cm | 121.1 L | 15.3 kg | 1.2 mil/30 µm | 1/300 pcs |
| FG500888 ^a | CLR | 264100, 264300, 395800, 395900, 905800, 9P9000, 264346, 264356, 9P9100, 965100, 965200 | 44.0" l x 37.0" w | 74" cir | 44–50 gal | 27.3 lb | 111.8 cm x 94 cm | 187.9 cm | 166.5–189.2 L | 12.4 kg | 1.2 mil/30 µm | 1/200 pcs |
| FG500988 ^a | GRAY | 354000, 354100, 396600, 396700, 614500, 614600, 818288, 355400, 354220 | 40.0" l x 29.3" w | 58½" cir | 20–32 gal | 29.9 lb | 101.6 cm x 74.3 cm | 148.5 cm | 75.7–121.1 L | 13.6 kg | 1.2 mil/30 µm | 1/300 pcs |
| FG501088 ^a | GRAY | 50-Gal (208.2-L) Drum | 60.0" l x 36.0" w | 72" cir | 55 gal | 18.4 lb | 152.4 cm x 91.4 cm | 182.8 cm | 208.2 L | 8.3 kg | 1.2 mil/30 µm | 1/100 pcs |
| FG501188 ^a | GRAY | 265500 | 48.0" l x 39.5" w | 79" cir | 55 gal | 27.0 lb | 121.9 cm x 100.3 cm | 200.6 cm | 208.2 L | 12.2 kg | 2.0 mil/50 µm | 1/100 pcs |
| FG501388 ^a | GRAY, CLR | 256800, 256806, 9W2700, 9W2706 | 47.0" l x 43.0" w | 86" cir | 56 gal | 28.7 lb | 119.4 cm x 109.2 cm | 218.4 cm | 212 L | 13 kg | 2.0 mil/50 µm | 1/100 pcs |
| FG501688 ^a | GRAY | 351700, 352600, 396300, 396400, 396500, 396800, 396900, 397000, 397100, 397200, 397500, 843000, 917100, 917200, 917300 | 42.5" l x 39.0" w | 78" cir | 45 gal | 28.3 lb | 108 cm x 99.1 cm | 198.1 cm | 170.3 L | 12.8 kg | 1.2 mil/30 µm | 1/200 pcs |
| FG502888 ^a | GRAY | 50-Gallon (189.3-L) Container 9W2700, 9W2706 | 47.0" l x 45.0" w | 90" cir | 50 gal | 30.0 lb | 119.4 cm x 114.3 cm | 228.6 cm | 189.3 L | 13.6 kg | 2.0 mil/50 µm | 1/100 pcs |

^aNot for sale in California.



Utility Refuse Waste Stream Label Kits*

The Waste Stream Label Kits contain ten intuitive waste stream decals, ensuring waste sortation accuracy.

Version A (1977785) Fits 20 Gal BRUTE® Containers, 23 and 35 Gal Untouchable Containers, and Medium and Large Wastebaskets

Version C (1977787) Fits 32 and 44 Gal BRUTE® Containers.

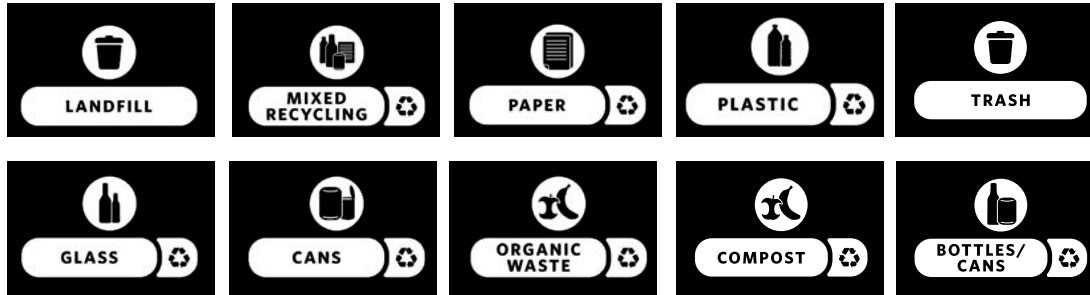

Version D (1977788) fits 50 Gal BRUTE® Rollout Containers and 1/2- and 1-Cubic-Yard Tilt Trucks

Version F (2018391) fits 16- and 23- Gal Slim Jim® Containers

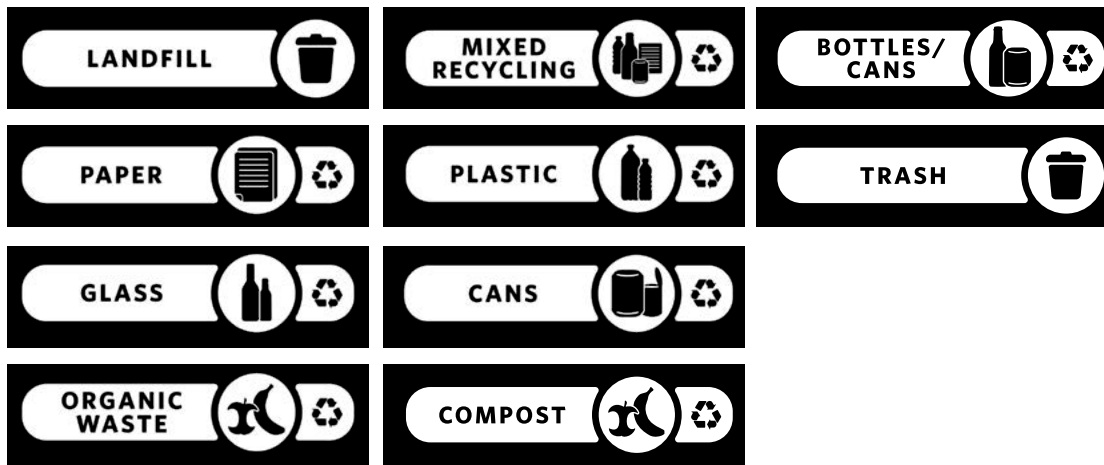

Version E (1977789) fits 16- and 23-Gal Slim Jim® Containers

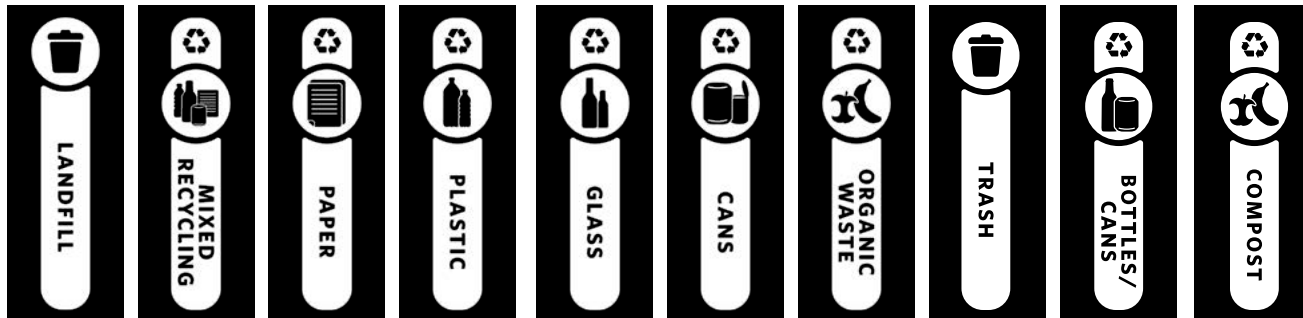

*Sized to fit correct container.

UTILITY REFUSE AND RECYCLING

DECORATIVE REFUSE

CLEANING

MATERIAL HANDLING

WASHROOM

FOODSERVICE

ACCESSORIES & INDEX

UTILITY REFUSE WASTE STREAM LABEL KITS

| NO. | DESCRIPTION | U.S. DIMENSIONS | PACK |
|---------|---|------------------|------|
| 1977785 | Waste Stream Label Kit Version A fits 20-Gallon BRUTE® Containers, 23- and 35-Gallon Untouchable® Containers, and Medium and Large Wastebaskets | 7.8" w x 4.6" h | 1 |
| 1977787 | Waste Stream Label Kit Version C fits 32- and 44-Gallon BRUTE® Containers | 9.5" w x 5.7" h | 1 |
| 1977788 | Waste Stream Label Kit Version D fits 50-Gallon BRUTE® Rollout Containers and 1/2- and 1-Cubic-Yard Tilt Trucks | 10.3" w x 2.6" h | 1 |
| 1977789 | Waste Stream Label Kit Version E fits 16- and 23-Gallon Slim Jim® Containers (Vertical orientation) | 2.6" w x 10.3" h | 1 |
| 2018391 | Waste Stream Label Kit Version F fits 16- and 23-Gallon Slim Jim® Containers (Horizontal orientation) | 7.5" w x 1.93" h | 1 |

* Labels have clear substrate to allow color of container to show through.



1956185, 1955959, 1956191



DECORATIVE REFUSE



FGR1536EOTPLBK



1961621, 1961629

DECORATIVE REFUSE

INDOOR/OUTDOOR CONTAINERS

Configure™48
Classics.....50

INDOOR CONTAINERS

Silhouettes.....51
Defenders®52
Round Tops.....53
Crowne.....53
Half Rounds.....54
Metallic Series54
Atrium®55
Slim Jim® Step-On Containers.....55
Metal Waste Stream Labls56
Eclipse57
Marshal® Classic.....57

OUTDOOR CONTAINERS

Aspen58
Dimension58
Americana Series™59
Atrium® Classic.....59
Landmark Series®60
Ranger®62
Plaza®63
Street Baskets.....64
Steel Drum Tops64
Glutton®64

SMOKING MANAGEMENT

Smokers' Station® Wall Mount65
Classic Smoking Urns and Accessories65
Ash/Trash Containers66
GroundsKeeper® Receptacles66
Infinity™ Smoking Management Solutions67
Metropolitan Smokers' Station68
Smokers' Pole69
Aladdin Smokers' Station®69
Waste Container Accessories70

Configure™

Configure™ decorative refuse containers have a modern appearance that will fit seamlessly into any commercial environment. Mix and match waste stream labels, capacities, and signage to meet facility-specific waste and recycling needs.

- Magnetic connection keeps the containers arranged in the order that best fits the space – in a row or an island
- Easy-access front door and handle allow for ergonomic emptying of waste
- Internal door hinge prevents unsightly wall damage and helps maintain a neat, clean appearance in commercial spaces



ADA COMPLIANT



INTERGRATED LINER CINCHES
INTEGRATED LINER HANDLES

EASY ACCESS FRONT DOOR



LINERS WITH VENTING CHANNELS

| SKU # | DESCRIPTION | FRONT COLOR | SIDE/BACK COLOR | LID STYLE | GALLONS | LENGTH | WIDTH | HEIGHT |
|---------|-------------------------|-------------------|-----------------|-----------|---------|--------|-------|--------|
| 1961614 | 15G with Landfill Label | Grey Stenni Gloss | Textured Black | Open Top | 15 | 14.41 | 18.50 | 37.97 |
| 1961615 | 15G with Mixed Label | Grey Stenni Gloss | Textured Black | Open Top | 15 | 14.41 | 18.50 | 37.97 |
| 1961616 | 15G with Paper Label | Grey Stenni Gloss | Textured Black | Open Top | 15 | 14.41 | 18.50 | 37.97 |
| 1961617 | 15G with Plastic Label | Grey Stenni Gloss | Textured Black | Open Top | 15 | 14.41 | 18.50 | 37.97 |
| 1961618 | 15G with Glass Label | Grey Stenni Gloss | Textured Black | Open Top | 15 | 14.41 | 18.50 | 37.97 |
| 1961619 | 15G with Cans Label | Grey Stenni Gloss | Textured Black | Open Top | 15 | 14.41 | 18.50 | 37.97 |
| 1961620 | 15G with Organic Label | Grey Stenni Gloss | Textured Black | Open Top | 15 | 14.41 | 18.50 | 37.97 |
| 1961621 | 23G with Landfill Label | Grey Stenni Gloss | Textured Black | Open Top | 23 | 19.21 | 18.50 | 37.97 |
| 1961622 | 23G with Mixed Label | Grey Stenni Gloss | Textured Black | Open Top | 23 | 19.21 | 18.50 | 37.97 |
| 1961623 | 23G with Paper Label | Grey Stenni Gloss | Textured Black | Open Top | 23 | 19.21 | 18.50 | 37.97 |
| 1961624 | 23G with Plastic Label | Grey Stenni Gloss | Textured Black | Open Top | 23 | 19.21 | 18.50 | 37.97 |
| 1961625 | 23G with Glass Label | Grey Stenni Gloss | Textured Black | Open Top | 23 | 19.21 | 18.50 | 37.97 |
| 1961626 | 23G with Cans Label | Grey Stenni Gloss | Textured Black | Open Top | 23 | 19.21 | 18.50 | 37.97 |
| 1961627 | 23G with Organic Label | Grey Stenni Gloss | Textured Black | Open Top | 23 | 19.21 | 18.50 | 37.97 |
| 1961628 | 33G with Landfill Label | Grey Stenni Gloss | Textured Black | Open Top | 33 | 24.02 | 18.50 | 37.97 |
| 1961629 | 33G with Mixed Label | Grey Stenni Gloss | Textured Black | Open Top | 33 | 24.02 | 18.50 | 37.97 |
| 1961630 | 33G with Paper Label | Grey Stenni Gloss | Textured Black | Open Top | 33 | 24.02 | 18.50 | 37.97 |
| 1961641 | 33G with Plastic Label | Grey Stenni Gloss | Textured Black | Open Top | 33 | 24.02 | 18.50 | 37.97 |
| 1961642 | 33G with Glass Label | Grey Stenni Gloss | Textured Black | Open Top | 33 | 24.02 | 18.50 | 37.97 |
| 1961505 | 33G with Cans Label | Grey Stenni Gloss | Textured Black | Open Top | 33 | 24.02 | 18.50 | 37.97 |
| 1961506 | 33G with Organic Label | Grey Stenni Gloss | Textured Black | Open Top | 33 | 24.02 | 18.50 | 37.97 |
| 1961507 | 45G with Landfill Label | Grey Stenni Gloss | Textured Black | Open Top | 45 | 28.82 | 18.50 | 37.97 |
| 1961508 | 45G with Mixed Label | Grey Stenni Gloss | Textured Black | Open Top | 45 | 28.82 | 18.50 | 37.97 |
| 1961509 | 45G with Paper Label | Grey Stenni Gloss | Textured Black | Open Top | 45 | 28.82 | 18.50 | 37.97 |
| 1961510 | 45G with Plastic Label | Grey Stenni Gloss | Textured Black | Open Top | 45 | 28.82 | 18.50 | 37.97 |
| 1961681 | 45G with Glass Label | Grey Stenni Gloss | Textured Black | Open Top | 45 | 28.82 | 18.50 | 37.97 |
| 1961682 | 45G with Cans Label | Grey Stenni Gloss | Textured Black | Open Top | 45 | 28.82 | 18.50 | 37.97 |
| 1961683 | 45G with Organic Label | Grey Stenni Gloss | Textured Black | Open Top | 45 | 28.82 | 18.50 | 37.97 |

UTILITY REFUSE AND RECYCLING

DECORATIVE REFUSE

CLEANING

MATERIAL HANDLING

WASHROOM

FOODSERVICE

ACCESSORIES & INDEX

Additional Signage

| SKU # | DESCRIPTION | FRONT COLOR | COMPATIBLE WITH THE FOLLOWING CONFIGURE CONTAINERS | LENGTH | WIDTH | HEIGHT |
|---------|--------------------------------|-------------|--|--------|-------|--------|
| 1961589 | 15G with Paper Label | Blue | 15 | 13.95 | 1.75 | 8.49 |
| 1961584 | 15G with Plastic Label | Red | 15 | 13.95 | 1.75 | 8.49 |
| 1961576 | 15G with Glass Label | Orange | 15 | 13.95 | 1.75 | 8.49 |
| 1961596 | 15G with Cans Label | Yellow | 15 | 13.95 | 1.75 | 8.49 |
| 1961580 | 15G with Organic Waste Label | Green | 15 | 13.95 | 1.75 | 8.49 |
| 1961572 | 15G with Landfill Label | Black | 15 | 13.95 | 1.75 | 8.49 |
| 1961588 | 15G with Mixed Recycling Label | Blue | 15 | 13.95 | 1.75 | 8.49 |
| 1961573 | 23G with Landfill Label | Black | 23 | 18.75 | 1.75 | 8.49 |
| 1961590 | 23G with Mixed Recycling Label | Blue | 23 | 18.75 | 1.75 | 8.49 |
| 1961591 | 23G with Paper Label | Blue | 23 | 18.75 | 1.75 | 8.49 |
| 1961585 | 23G with Plastic Label | Red | 23 | 18.75 | 1.75 | 8.49 |
| 1961577 | 23G with Glass Label | Orange | 23 | 18.75 | 1.75 | 8.49 |
| 1961597 | 23G with Cans Label | Yellow | 23 | 18.75 | 1.75 | 8.49 |
| 1961581 | 23G with Organic Waste Label | Green | 23 | 18.75 | 1.75 | 8.49 |
| 1961574 | 33G with Landfill Label | Black | 33 | 23.55 | 1.75 | 8.49 |
| 1961592 | 33G with Mixed Recycling Label | Blue | 33 | 23.55 | 1.75 | 8.49 |
| 1961593 | 33G with Paper Label | Blue | 33 | 23.55 | 1.75 | 8.49 |
| 1961586 | 33G with Plastic Label | Red | 33 | 23.55 | 1.75 | 8.49 |
| 1961578 | 33G with Glass Label | Orange | 33 | 23.55 | 1.75 | 8.49 |
| 1961598 | 33G with Cans Label | Yellow | 33 | 23.55 | 1.75 | 8.49 |
| 1961582 | 33G with Organic Waste Label | Green | 33 | 23.55 | 1.75 | 8.49 |
| 1961575 | 45G with Landfill Label | Black | 45 | 28.36 | 1.75 | 8.49 |
| 1961594 | 45G with Mixed Recycling Label | Blue | 45 | 28.36 | 1.75 | 8.49 |
| 1961595 | 45G with Paper Label | Blue | 45 | 28.36 | 1.75 | 8.49 |
| 1961587 | 45G with Plastic Label | Red | 45 | 28.36 | 1.75 | 8.49 |
| 1961579 | 45G with Glass Label | Orange | 45 | 28.36 | 1.75 | 8.49 |
| 1961599 | 45G with Cans Label | Yellow | 45 | 28.36 | 1.75 | 8.49 |
| 1961583 | 45G with Organic Waste Label | Green | 45 | 28.36 | 1.75 | 8.49 |



1961572/1961614, 1961588/1961616, 1961596/1961619, 1961580/1961620

Classics

The heavy-duty Classics decorative refuse container has a perforated steel design for a clean and modern appearance. This container is a smart choice for high-traffic areas and can be used both outdoors and indoors.

- Retainer bands discreetly hold liner bags in place and out of sight
- Lid is fastened to receptacle with a cable, making it easier to collect waste
- Heavy-Gauge Steel for lasting durability in high-traffic areas
- Includes rigid plastic liner



ADA COMPLIANT



FGS3SSTSSPL

| SKU # | DESCRIPTION | COLOR | GALLONS | LENGTH | WIDTH | HEIGHT |
|---------------|-------------------|--------------------------|---------|--------|-------|--------|
| FGS3ETBKPL | Open Top 94L/25G | Textured Black | 25 | 18.00 | 18.00 | 36.00 |
| FGS3ETHBZPL | Open Top 94L/25G | Textured Bronze | 25 | 18.00 | 18.00 | 36.00 |
| FGS3ETSMPLBK | Open Top 94L/25G | Stardust Silver Metallic | 25 | 18.00 | 18.00 | 36.00 |
| FGS3SSTSSPL | Open Top 94L/25G | Stainless Steel | 25 | 18.00 | 18.00 | 36.00 |
| FGS55ETBKPL | Open Top 193L/51G | Textured Black | 51 | 24.00 | 24.00 | 36.00 |
| FGS55ETSMPLBK | Open Top 193L/51G | Stardust Silver Metallic | 51 | 24.00 | 24.00 | 36.00 |
| FGS55SSTSSPL | Open Top 193L/51G | Stainless Steel | 51 | 24.00 | 24.00 | 36.00 |



FGS55SSTSSPL

When ordering products with **BOLD** color codes, please specify color code after the product number. Refer to the Standard Color Guide at the back of the catalog.

Silhouettes

The sleek Silhouettes decorative refuse container has a contemporary graphic pattern designed to seamlessly and beautifully blend with indoor modern environments.

- Lid is fastened to receptacle for easy waste removal
- Optional waste stream decals and lid shape openings available for easier recycling compliance
- Leg levelers provide stability on uneven surfaces
- Includes rigid plastic liner



ADA COMPLIANT

DISCREET LABELS:



*Additional Waste Stream Labels on page 56



Large Rectangle
FGSR18SSPL



Square Open Top
FGSC18EPLTBK

| SKU # | DESCRIPTION | COLOR | GALLONS | LENGTH | WIDTH | HEIGHT |
|--------------|---|--------------------------|---------|--------|-------|--------|
| FGSR14EPLSM | Small Rectangle 49L/13G | Stardust Silver Metallic | 13 | 19.49 | 9.76 | 30.35 |
| FGSR14SSPL | Small Rectangle 49L/13G | Stainless Steel | 13 | 19.49 | 9.76 | 30.35 |
| FGSC14EPLSM | Square Open Top 60L/16G | Stardust Silver Metallic | 16 | 14.76 | 14.76 | 30.35 |
| FGSC14SSPL | Square Open Top 60L/16G | Stainless Steel | 16 | 14.76 | 14.76 | 30.35 |
| FGSC14EPLTBK | Square Open Top 60L/16G | Textured Black | 16 | 14.76 | 14.76 | 30.35 |
| FGSC14SSPL | Square Open Top 60L/16G | Stainless Steel | 16 | 14.76 | 14.76 | 30.35 |
| FGSC18EPLSM | Square Open Top 75L/20G | Stardust Silver Metallic | 20 | 18.39 | 18.39 | 30.35 |
| FGSC18SSPL | Square Open Top 75L/20G | Stainless Steel | 20 | 18.39 | 18.39 | 30.35 |
| FGSC18EPLTBK | Square Open Top 75L/20G | Textured Black | 20 | 18.39 | 18.39 | 30.35 |
| FGSR18EPLSM | Large Rectangle 85L/22.5G | Stardust Silver Metallic | 22.5 | 24.02 | 12.01 | 30.35 |
| FGSR18SSPL | Large Rectangle 85L/22.5G | Stainless Steel | 22.5 | 24.02 | 12.01 | 30.35 |
| FGSR18EPLTBK | Large Rectangle 85L/22.5G | Textured Black | 22.5 | 24.02 | 12.01 | 30.35 |
| FGDCR24CSM | Square Recycle With Bottles/Cans Lid/Label 109L/29G | Stardust Silver Metallic | 29 | 18.39 | 18.39 | 32.20 |
| FGDCR24TSM | Square Recycle With Landfill Lid/Label 109L/29G | Stardust Silver Metallic | 29 | 18.39 | 18.39 | 32.20 |
| FGSC22EPLSM | Square Open Top 151L/40G | Stardust Silver Metallic | 40 | 21.73 | 21.73 | 30.35 |
| FGSC22SSPL | Square Open Top 151L/40G | Stainless Steel | 40 | 21.73 | 21.73 | 30.35 |
| FGSC22EPLTBK | Square Open Top 151L/40G | Textured Black | 40 | 21.73 | 21.73 | 30.35 |

UTILITY REFUSE
AND RECYCLING

DECORATIVE REFUSE

CLEANING

MATERIAL HANDLING

WASHROOM

FOODSERVICE

ACCESSORIES
& INDEX



Defenders®

The Defenders® decorative refuse container is an ideal indoor waste receptacle for hospitals, doctors' offices and other healthcare facilities. The step-on foot pedal enables hands-free operation, optimizing sanitary efforts.

- Restraint mechanism protects walls
- Smooth Surfaces are Easy to Clean
- Leak-proof Rigid Plastic Liner Contains Liquids and Keeps The Surrounding Area Cleaner



FGST24EPLRD



| SKU # | DESCRIPTION | COLOR | GALLONS | LENGTH | WIDTH | HEIGHT |
|-------------|--------------------------|-----------------|---------|--------|-------|--------|
| FGST7EPLRD | Square Step Can 26L/7G | Red Gloss | 4 | 13.50 | 14.25 | 17.63 |
| FGST7EPLWH | Square Step Can 26L/7G | Sky White Gloss | 4 | 13.50 | 14.25 | 17.63 |
| FGST7SSPL | Square Step Can 26L/7G | Stainless Steel | 4 | 13.50 | 14.25 | 17.63 |
| FGST12EPLWH | Square Step Can 45L/12G | Sky White Gloss | 6.5 | 13.50 | 14.25 | 23.63 |
| FGST12EPLRD | Square Step Can 45L/12G | Red Gloss | 6.5 | 13.50 | 14.25 | 23.63 |
| FGST12SSPL | Square Step Can 45L/12G | Stainless Steel | 6.5 | 13.50 | 14.25 | 23.63 |
| FGST24EPLWH | Square Step Can 90L/24G | Sky White Gloss | 13 | 16.00 | 16.75 | 30.63 |
| FGST24SSPL | Square Step Can 90L/24G | Stainless Steel | 13 | 16.00 | 16.75 | 30.63 |
| FGST24EPLRD | Square Step Can 90L/24G | Red Gloss | 13 | 16.00 | 16.75 | 30.63 |
| FGST40EPLRD | Square Step Can 151L/40G | Red Gloss | 25 | 20.00 | 21.13 | 30.63 |
| FGST40EPLWH | Square Step Can 151L/40G | Sky White Gloss | 25 | 20.00 | 21.13 | 30.63 |
| FGST40SSPL | Square Step Can 151L/40G | Stainless Steel | 25 | 20.00 | 21.13 | 30.63 |

| | | | |
|--|--------------------------------------|--|---|
|  BIOHAZARD PELIGRO BIOLÓGICO FGCL1* | SOILED LINEN ROPA SUCIA FGCL2* | TRASH ONLY BASURA SOLAMENTE FGCL3* | INFECTIOUS WASTE BASURA INFECCIOSA FGCL4* |
|--|--------------------------------------|--|---|

Medical Waste Labels

| SKU # | DESCRIPTION | DIMENSIONS | PACK SIZE |
|-------|--|--------------------|-----------|
| FGCL1 | English/Spanish Label "Biohazard" | 10.00" w x 7.00" h | 1 |
| FGCL2 | English/Spanish Label "Soiled Linen" | 10.00" w x 4.00" h | 1 |
| FGCL3 | English/Spanish Label "Trash Only" | 10.00" w x 4.00" h | 1 |
| FGCL4 | English/Spanish Label "Infectious Waste" | 10.00" w x 4.00" h | 1 |



FGST40EPLWH

When ordering products with **BOLD** color codes, please specify color code after the product number. Refer to the Standard Color Guide at the back of the catalog.

UTILITY REFUSE
AND RECYCLING

DECORATIVE REFUSE

CLEANING

MATERIAL HANDLING

WASHROOM

FOODSERVICE

ACCESSORIES
& INDEX

Round Tops

The Round Tops decorative refuse container has a sleek design that beautifully blends into any indoor environment. These containers feature a bottom rim that is designed to protect flooring.

- The push door style features a self-closing push door to help control odor



Open Top
FGR32SSSGL

Dome Top
FGR1536EOTPLBK

Push Door"
FGR1536EPLWH

| SKU # | DESCRIPTION | COLOR | LINER TYPE | GALLONS | LENGTH | WIDTH | HEIGHT |
|----------------|-------------------|-----------------|------------|---------|--------|-------|--------|
| FGR1536EGLBK | Push Door 56L/15G | Black Gloss | Galvanized | 15 | 15.00 | 15.00 | 35.84 |
| FGR1536EPLBK | Push Door 56L/15G | Black Gloss | Plastic | 15 | 15.00 | 15.00 | 35.84 |
| FGR1536SSSGL | Push Door 56L/15G | Stainless Steel | Galvanized | 15 | 15.00 | 15.00 | 35.84 |
| FGR1536SSSPL | Push Door 56L/15G | Stainless Steel | Plastic | 15 | 15.00 | 15.00 | 35.84 |
| FGR1536MCPL | Push Door 56L/15G | Mirror Chrome | Plastic | 15 | 15.00 | 15.00 | 35.84 |
| FGR1536MCGL | Push Door 56L/15G | Mirror Chrome | Galvanized | 15 | 15.00 | 15.00 | 35.84 |
| FGR1536EOTGLBK | Dome Top/56L/115G | Black Gloss | Galvanized | 15 | 15.00 | 15.00 | 33.86 |
| FGR1536EOTPLBK | Dome Top/56L/115G | Black Gloss | Plastic | 15 | 15.00 | 15.00 | 33.86 |
| FGR32EGLBK | Open Top 56L/15G | Black Gloss | Galvanized | 15 | 15.00 | 15.00 | 31.10 |
| FGR32SSSGL | Open Top 56L/15G | Stainless Steel | Galvanized | 15 | 15.00 | 15.00 | 31.10 |
| FGR32MCGL | Open Top 56L/15G | Mirror Chrome | Galvanized | 15 | 15.00 | 15.00 | 31.10 |
| FGR32EGLWH | Open Top 56L/15G | Sky White Gloss | Galvanized | 15 | 15.00 | 15.00 | 31.10 |
| FGR1536EPLWH | Push Top 56L/15G | Sky White Gloss | Plastic | 15 | 15.00 | 15.00 | 35.84 |
| FGR1536EGLWH | Push Top 56L/15G | Sky White Gloss | Galvanized | 15 | 15.00 | 15.00 | 35.84 |

Crowne

The Crowne decorative refuse indoor container has an attractive contemporary design with a curved open top that prevents objects from being placed on top of the can, keeping a neater overall appearance.

- Base of receptacle is designed to protect floors
- Receptacles have a large opening for easy waste disposal
- Includes rigid plastic liner



FGAOT15BKPL

| SKU # | DESCRIPTION | COLOR | GALLONS | LENGTH | WIDTH | HEIGHT |
|-------------|-------------------|----------------|---------|--------|-------|--------|
| FGAOT15SAPL | Open Top 45L/12G | Satin Aluminum | 12 | 15.00 | 15.00 | 30.00 |
| FGAOT15BKPL | Open Top 45L/12G | Black Gloss | 12 | 15.00 | 15.00 | 30.00 |
| FGAOT30SAPL | Open Top 113L/30G | Satin Aluminum | 30 | 20.00 | 20.00 | 34.50 |
| FGAOT30BKPL | Open Top 113L/30G | Black Gloss | 30 | 20.00 | 20.00 | 34.50 |

UTILITY REFUSE
AND RECYCLING

DECORATIVE REFUSE

CLEANING

MATERIAL HANDLING

WASHROOM

FOODSERVICE

ACCESSORIES
& INDEX



Half Rounds

The Half Rounds Series decorative refuse container fits flush against walls to conserve space. The sleek and functional design of this receptacle blends seamlessly with upscale and modern indoor facilities.

- Bottom rim is designed to protect floors
- Includes rigid plastic liner



ADA COMPLIANT



Flat Top
FGSO820PLANT

Ash/Trash
FGSO8SUSSSPL

Open Top
FGSH12SSPL

| SKU # | DESCRIPTION | COLOR | GALLONS | LENGTH | WIDTH | HEIGHT |
|---------------|------------------|------------------------------------|---------|--------|-------|--------|
| FGSO8SSSPL | Flat Top 34L/9G | Stainless Steel | 9 | 8.80 | 17.60 | 32.50 |
| FGSO820PLBK | Flat Top 34L/9G | Black Gloss W/ Chrome Trim | 9 | 8.80 | 17.60 | 32.50 |
| FGSO820PLANT | Flat Top 34L/9G | Anthracite Metallic W/ Chrome Trim | 9 | 8.80 | 17.60 | 32.50 |
| FGSO8SUSSSPL | Ash/Trash 34L/9G | Stainless Steel | 9 | 8.80 | 17.60 | 33.00 |
| FGSO8SU20PLBK | Ash/Trash 34L/9G | Black Gloss W/ Chrome Trim | 9 | 8.80 | 17.60 | 33.00 |
| FGSH12SSPL | Open Top 45L/12G | Stainless Steel | 12 | 8.80 | 17.60 | 32.40 |
| FGSO12SSSPL | Open Top 45L/12G | Stainless Steel | 12 | 8.80 | 17.60 | 32.50 |
| FGSO1220PLBK | Open Top 45L/12G | Black Gloss W/ Chrome Trim | 12 | 8.80 | 17.60 | 32.50 |
| FGSH12EPLSM | Open Top 45L/12G | Stardust Silver Metallic | 12 | 8.80 | 17.60 | 32.40 |
| FGSH12EPLTBK | Open Top 45L/12G | Textured Black | 12 | 8.80 | 17.60 | 32.40 |

Metallic Series

The Metallic Series decorative refuse container has a sleek design that blends nicely with upscale interiors.

- A protective vinyl trim is applied to the disposal opening of the Flat Top and Ash/Trash containers to help withstand the rigors of everyday use
- Bottom rim designed to protect floors
- Flat top style has a large opening for easy waste disposal
- Includes galvanized liner



ADA COMPLIANT



CSFM



Ash/Trash
FGSO16SUSSGSL

Open Top
FGCC16SSGSL

Flat Top
FGSO16SSGSL

| SKU # | DESCRIPTION | COLOR | GALLONS | LENGTH | WIDTH | HEIGHT |
|---------------|-------------------|-----------------------|---------|--------|-------|--------|
| FGSO16SSGSL | Flat Top 45L/12G | Satin Stainless Steel | 12 | 15.00 | 15.00 | 35.84 |
| FGSO16SUSSGSL | Ash/Trash 45L/12G | Satin Stainless Steel | 12 | 15.00 | 15.00 | 28.52 |
| FGCC16SSGSL | Open Top 56L/15G | Satin Stainless Steel | 15 | 15.00 | 15.00 | 27.95 |

Atrium®

Durable and corrosion-resistant, the Atrium® decorative refuse indoor container has a clean, classic look. Exterior surfaces are highly polished for a smooth and blemish-free appearance.

- Designed to conceal and securely hold liner bags



ADA COMPLIANT



FGAOT35SAGL

| SKU # | DESCRIPTION | COLOR | GALLONS | LINER TYPE | LENGTH | WIDTH | HEIGHT |
|---------------|-------------------|----------------|---------|------------|--------|-------|--------|
| FGAOT35SAGL | Open Top 79L/21G | Satin Aluminum | 21 | Galvanized | 18.00 | 18.00 | 32.00 |
| FGAOT35SAPL | Open Top 79L/21G | Satin Aluminum | 21 | Plastic | 18.00 | 18.00 | 32.00 |
| FGAOT35SA | Open Top 132L/35G | Satin Aluminum | 35 | - | 18.00 | 18.00 | 32.00 |
| FG907900HSILV | Open Top 132L/35G | Silver | 35 | - | 18.00 | 18.00 | 32.00 |
| FGAOT62SAPL | Open Top 208L/55G | Satin Aluminum | 55 | Plastic | 24.00 | 24.00 | 35.00 |
| FGAOT62SA | Open Top 234L/62G | Satin Aluminum | 62 | - | 24.00 | 24.00 | 35.00 |

Slim Jim® Step-On Containers

Step-On containers are the smart choice for large-capacity, hands-free waste collection. Attractive design is suitable for front- and back-of-house applications.

- Includes rigid plastic liner



OSHA OBRA



Stainless Steel Step-On Containers

| NO. | COLOR | DESCRIPTION | GALLONS | U.S. DIMENSIONS | U.S. SHIP WT/CTN | METRIC DIMENSIONS | METRIC CAPACITY | METRIC SHIP WT/CTN | PACK |
|---------|-----------------|--|---------|-----------------------------|------------------|--------------------------|-----------------|--------------------|------|
| 1901982 | Stainless Steel | Stainless Steel Front Step | 4 | 15.6" l x 11.9" w x 15.7" h | 9.6 lb | 396 mm x 302 mm x 400 mm | 15 L | 4.364 kg | 1 |
| 1901985 | Stainless Steel | Stainless Steel Front Step | 8 | 16.8" l x 12.8" w x 21.9" h | 13.0 lb | 427 mm x 326 mm x 555 mm | 30 L | 5.909 kg | 1 |
| 1901987 | Stainless Steel | Stainless Steel Front Step with Dual Liner | 8 | 16.8" l x 12.8" w x 21.9" h | 13.4 lb | 427 mm x 326 mm x 555 mm | 30 L | 6.091 kg | 1 |
| 1901992 | Stainless Steel | Stainless Steel Front Step | 13 | 18.1" l x 13.7" w x 28.7" h | 17.7 lb | 460 mm x 348 mm x 728 mm | 50 L | 8.045 kg | 1 |
| 1901994 | Stainless Steel | Stainless Steel Front Step with Dual Liner | 13 | 18.1" l x 13.7" w x 28.7" h | 19.1 lb | 460 mm x 348 mm x 728 mm | 50 L | 8.682 kg | 1 |
| 1901993 | Stainless Steel | Stainless Steel End Step | 13 | 22.7" l x 11.6" w x 28.9" h | 17.8 lb | 576 mm x 295 mm x 733 mm | 50 L | 8.091 kg | 1 |
| 1901999 | Stainless Steel | Stainless Steel Front Step | 24 | 21.8" l x 16.2" w x 31.8" h | 24.0 lb | 553 mm x 412 mm x 808 mm | 90 L | 10.909 kg | 1 |
| 1902001 | Stainless Steel | Stainless Steel Front Step with Dual Liner | 24 | 21.8" l x 16.2" w x 31.8" h | 25.4 lb | 553 mm x 412 mm x 808 mm | 90 L | 11.545 kg | 1 |
| 1902000 | Stainless Steel | Stainless Steel End Step | 24 | 27.2" l x 13.1" w x 32.8" h | 26.0 lb | 690 mm x 333 mm x 834 mm | 90 L | 11.818 kg | 1 |



Metal Waste Stream Labels

Choose between ten expert-designed waste stream labels that feature colors, icons, and visual cues proven to improve recycling rates.

Colored Labels



Discreet Labels



Colored Waste Stream Labels

| SKU # | DESCRIPTION | DIMENSIONS | PACK SIZE |
|---------|-----------------------|--------------------|-----------|
| 1987863 | Landfill Label | 10.01" w x 2.56" h | 1 |
| 1988003 | Plastic Label | 10.01" w x 2.56" h | 1 |
| 1988011 | Compost Label | 10.01" w x 2.56" h | 1 |
| 1988009 | Organic Waste Label | 10.01" w x 2.56" h | 1 |
| 1987867 | Paper Label | 10.01" w x 2.56" h | 1 |
| 1988001 | Cans Label | 10.01" w x 2.56" h | 1 |
| 1988005 | Bottles/Cans Label | 10.01" w x 2.56" h | 1 |
| 1987865 | Trash Label | 10.01" w x 2.56" h | 1 |
| 1987869 | Mixed Recycling Label | 10.01" w x 2.56" h | 1 |
| 1988007 | Glass Label | 10.01" w x 2.56" h | 1 |

Discreet Waste Stream Labels

| SKU # | DESCRIPTION | DIMENSIONS | PACK SIZE |
|---------|-----------------------|-------------------|-----------|
| 1988023 | Plastic Label | 6.88" w x 1.73" h | 1 |
| 1988015 | Trash Label | 6.88" w x 1.73" h | 1 |
| 1988021 | Cans Label | 6.88" w x 1.73" h | 1 |
| 1988017 | Paper Label | 6.88" w x 1.73" h | 1 |
| 1988031 | Compost Label | 6.88" w x 1.73" h | 1 |
| 1988027 | Glass Label | 6.88" w x 1.73" h | 1 |
| 1988019 | Mixed Recycling Label | 6.88" w x 1.73" h | 1 |
| 1988025 | Bottles/Cans Label | 6.88" w x 1.73" h | 1 |
| 1988029 | Organic Waste Label | 6.88" w x 1.73" h | 1 |
| 1988013 | Landfill Label | 6.88" w x 1.73" h | 1 |

When ordering products with **BOLD** color codes, please specify color code after the product number. Refer to the Standard Color Guide at the back of the catalog.

Eclipse

With its exclusive curved top, the Eclipse decorative refuse container offers a stylish addition to any contemporary décor.

- Designed with a curved top to prevent the placement of objects on the top edge
- Includes rigid plastic liner



FGR2030EPLBK

| SKU # | DESCRIPTION | COLOR | GALLONS | LENGTH | WIDTH | HEIGHT |
|--------------|-------------------------------|-----------------|---------|--------|--------|--------|
| FGR2030SSPL | Eclipse Open Top Metal Refuse | Stainless Steel | 30 | 20.00" | 20.00" | 33.50" |
| FGR2030EPLBK | Eclipse Open Top Metal Refuse | Black Gloss | 30 | 20.00" | 20.00" | 33.50" |

Marshal® Classic Containers

Practical good looks combined with fire safety.

- Includes retainer hardware for securing and concealing can liners
- Textured finish minimizes the appearance of surface scratches



FG816088BEIG

FG817088BLA

FG816088OWHT

Marshal® Classic Containers

| NO. | COLOR | DESCRIPTION | CAPACITY (GAL) | CAPACITY (LITERS) | U.S. DIMENSIONS | U.S. SHIP WT/CTN | METRIC DIMENSIONS | METRIC SHIP WT/CTN |
|------------|----------------------|---|----------------|-------------------|----------------------|------------------|------------------------|--------------------|
| FG816088*1 | BEIG, BLA, BRN, OWHT | Marshal® Classic Container | 15 | 56.8 | 15.38" dia x 36.5" h | 20.1 lb | 39.1 cm dia x 92.7 cm | 9.1 kg |
| FG817088*1 | BEIG, BLA, BRN, OWHT | Marshal® Classic Container | 25 | 94.6 | 18" dia x 42" h | 23.0 lb | 45.7 cm dia x 106.7 cm | 10.4 kg |
| FG355000 | GRAY | Rigid Liner for FG816088 Container | 12½ | 45.9 L | 12" dia x 27.25" h | 16.2 lb | 30.5 cm dia x 69.2 cm | 7.3 kg |
| FG355200 | GRAY | Rigid Liner with Rim for FG817088 Container | 22 | 83.3 L | 14.5" dia x 30.13" h | 26.9 lb | 36.8 cm dia x 76.5 cm | 12.2 kg |

Beige (BEIG), Black (BLA), Brown (BRN), Off White (OWHT) *1FM-Approved

UTILITY REFUSE AND RECYCLING

DECORATIVE REFUSE

CLEANING

MATERIAL HANDLING

WASHROOM

FOODSERVICE

ACCESSORIES & INDEX



Aspen

The Aspen decorative refuse container's stone panels naturally blend this receptacle into any outdoor environment.

- Durable powder coat finish withstands severe weather and resists fading even when exposed to harsh UV rays
- Hinged lid style enables easy waste removal
- Adjustable leg levelers create stability on uneven surfaces
- Includes rigid plastic liner



ADA COMPLIANT



Hinged Top
FGR36HT201PL



Ash/Trash
FGR12SU201PL

| SKU # | DESCRIPTION | COLOR | GALLONS | LENGTH | WIDTH | HEIGHT |
|--------------|---------------------|----------------------------------|---------|--------|-------|--------|
| FGR12SU201PL | Ash/Trash 45L/12G | Brown Gloss Trim W/ Brown Panels | 12 | 13.50 | 13.50 | 32.00 |
| FGR18SU201PL | Ash/Trash 90L/24G | Brown Gloss Trim W/ Brown Panels | 24 | 18.00 | 18.00 | 32.00 |
| FGR36HT201PL | Hinged Top 109L/29G | Brown Gloss Trim W/ Brown Panels | 29 | 21.00 | 21.00 | 40.00 |
| FGR38HT201PL | Hinged Top 143L/38G | Brown Gloss Trim W/ Brown Panels | 38 | 26.00 | 26.00 | 40.00 |
| FGR48HT201PL | Hinged Top 181L/48G | Brown Gloss Trim W/ Brown Panels | 48 | 26.00 | 26.00 | 40.00 |

Dimension

The Dimension decorative refuse container's perforated steel panels create an upscale, dimensional look that complements contemporary outdoor environments.

- Durable powder coat finish withstands severe weather and resists fading even when exposed to harsh UV rays
- Hinged lid style enables easy waste removal
- Adjustable leg levelers create stability on uneven surfaces
- Includes rigid plastic liner



ADA COMPLIANT



Hinged Top
FGR38HT500PL



Ash/Trash with
Weather Shield
FGR18WU500PL

| SKU # | DESCRIPTION | COLOR | GALLONS | LENGTH | WIDTH | HEIGHT |
|--------------|----------------------------------|--|---------|--------|-------|--------|
| FGR18WU500PL | Ash/Trash Weather Shield 90L/24G | Black Gloss W/ Anthracite Metallic Perf Panels | 24 | 18.00 | 18.00 | 35.00 |
| FGR36HT500PL | Hinged Top 109L/29G | Black Gloss W/ Anthracite Metallic Perf Panels | 29 | 21.00 | 21.00 | 40.00 |
| FGR38HT500PL | Hinged Top 143L/38G | Black Gloss W/ Anthracite Metallic Perf Panels | 38 | 26.00 | 26.00 | 40.00 |
| FGR48HT500PL | Hinged Top 181L/48G | Black Gloss W/ Anthracite Metallic Perf Panels | 48 | 26.00 | 26.00 | 40.00 |

Americana Series™

The Americana Series™ offers rugged steel with multiple layers of powder coating to ensure years of trouble-free outdoor use.

- Adjustable leg levelers for stability on uneven surfaces
- Extremely heavy to deter theft and withstand harsh weather conditions



FGMT32PLABZ

| SKU # | COLOR | DESCRIPTION | GALLONS | LENGTH | WIDTH | HEIGHT |
|--------|--|----------------------------|---------|--------|-------|--------|
| FGMT22 | Architectural Bronze (PLABZ) Black (PLBK) | Americana Series™ Open Top | 24 | 25.5 | 25.5 | 25.5 |
| FGMT32 | Architectural Bronze (PLABZ) Black (PLBK) Green (PLVSGN) | Americana Series™ Open Top | 36 | 29 | 29 | 32.5 |

Atrium® Classic Containers

Attractive open top containers for hygienic waste disposal.

- FG905800 combines the durability of plastic, a hands-free funnel top, and the fire protection of a closed top
- Heavy-duty plastic construction with molded-in color and UV inhibitors
- Textured finish helps minimize appearance of surface scratches
- Built-in side handles ease lifting
- FG905800 is FM-Approved



FG905800BLA

Atrium® Classic

| NO. | COLOR | DESCRIPTION | U.S. DIMENSIONS | U.S. CAPACITY | U.S. SHIP WT/CTN | CAN LINERS | PACK |
|-----------|-------|---|-------------------|---------------|------------------|----------------------|------|
| FG905800* | BLA | Atrium® Classic Container with Funnel Top | 25" dia x 33.3" h | 35 gal | 23.5 lb | 5008-88 ^a | 1 |
| FG905886 | WGRAN | Atrium® Classic Container with Funnel Top | 25" dia x 33.3" h | 35 gal | 23.5 lb | 5008-88 ^a | 1 |

^aNot for sale in California.



FGR48HTWU500PL



**Landmark Series®
Classic Containers**

High-volume refuse collection and smoking management for indoor and outdoor areas, including building entrances, lobbies, and malls.

- Choose Dome Top model for outdoor use or Funnel Top model for indoor use
- Tops are hinged and include a stay-open strap for easy access to rigid liner
- Ash/Trash models include metal sand pan and large refuse openings
- Locking Dome Top model (FG397088) provides added security



UTILITY REFUSE
AND RECYCLING

DECORATIVE REFUSE

CLEANING

MATERIAL HANDLING

WASHROOM

FOODSERVICE

ACCESSORIES
& INDEX

STEP 1: CHOOSE FRAME STYLE, SIZE, AND COLOR

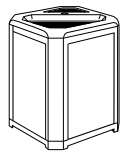

**FUNNEL TOP
ASH/TRASH
CONTAINER**
Available in 20G and
35G in Sable and
Dark Wood

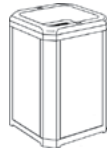

FUNNEL TOP
Available in 20G and
35G in Sable

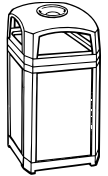

**DOME TOP
ASH/TRASH
CONTAINER**
Available in 35G and
50G in Sable, Dark
Wood, and Black

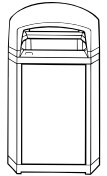

DOME TOP
Available in 35G and
50G in Sable, Dark
Wood, and Black

STEP 2: CHOOSE PANELS (4 PANELS PER UNIT)

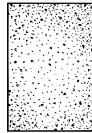

FG400200
Fits 20-Gal Landmark Series®
Containers



Coral **River Rock**
CORL ROCK

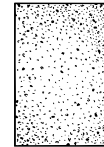

FG400300
Fits 35-Gal Landmark Series®
Containers



Brown Stone **Coral** **River Rock**
BSTON CORL ROCK

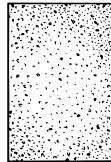

FG400400
Fits 50-Gal Landmark Series®
Containers



Brown Stone **Coral** **River Rock**
BSTON CORL ROCK

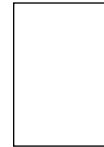

FG400600
Clear Panel for FG397000,
FG397001, FG397088, FG397100,
FG397200 Containers

Landmark Series® Frames

| NO. | COLOR | DESCRIPTION (W/O PANELS) | CAPACITY (GAL) | CAPACITY (LITERS) | U.S. DIMENSIONS | U.S. SHIP WT/CTN | METRIC DIMENSIONS | METRIC SHIP WT/CTN |
|----------|-------------------------|--|----------------|-------------------|------------------|------------------|----------------------|--------------------|
| FG396600 | SBLE, DWOOD | Landmark Series® Classic Container, Ash/Trash Frame with FG356988 Rigid Liner | 20 | 75.7 | 21" sq x 30.5" h | 32.8 lb | 53.3 cm sq x 77.5 cm | 14.9 kg |
| FG396700 | SBLE | Landmark Series® Classic Container, Funnel Top Frame with FG356988 Rigid Liner | 20 | 75.7 | 21" sq x 30.5" h | 33.6 lb | 53.3 cm sq x 77.5 cm | 15.2 kg |
| FG397000 | SBLE, DWOOD, BLA | Landmark Series® Classic Container, Dome Top Frame with FG395800 Rigid Liner | 35 | 132.5 | 26" sq x 40" h | 49.6 lb | 66 cm sq x 101.6 cm | 22.5 kg |
| FG397001 | SBLE, DWOOD, BLA | Landmark Series® Classic Container, Dome Top with Ash Tray, Frame and FG395800 Rigid Liner | 35 | 132.5 | 26" sq x 40" h | 51.6 lb | 66 cm sq x 101.6 cm | 23.4 kg |
| FG397088 | BLA | Landmark Series® Classic Container, Dome Top Frame with Lock Option, with FG395800 Rigid Liner | 35 | 132.5 | 26" sq x 40" h | 48.9 lb | 66 cm sq x 101.6 cm | 22.2 kg |
| FG397100 | SBLE, DWOOD | Landmark Series® Classic Container, Ash/Trash Frame with FG395800 Rigid Liner | 35 | 132.5 | 26" sq x 30.5" h | 43.4 lb | 66 cm sq x 77.5 cm | 19.7 kg |
| FG397200 | SBLE | Landmark Series® Classic Container, Funnel Top Frame with FG395800 Rigid Liner | 35 | 132.5 | 26" sq x 30.5" h | 43.0 lb | 66 cm sq x 77.5 cm | 19.5 kg |
| FG397500 | SBLE, DWOOD, BLA | Landmark Series® Classic Container, Dome Top Frame with FG395900 Rigid Liner | 50 | 189.3 | 26" sq x 46.5" h | 55.5 lb | 66 cm sq x 118.1 cm | 25.2 kg |
| FG397501 | SBLE, DWOOD, BLA | Landmark Series® Classic Container, Dome Top with Ash Tray, Frame and FG395900 Rigid Liner | 50 | 189.3 | 26" sq x 46.5" h | 58.2 lb | 66 cm sq x 118.1 cm | 26.4 kg |

Landmark Series® Panels (Sold Separately)

| NO. | COLOR | DESCRIPTION (W/O PANELS) |
|----------|--------------------------|---|
| FG400200 | CORL, ROCK | 20G Landmark Series® Panel for FG396600 and FG396700 |
| FG400300 | BSTON, CORL, ROCK | 35G Landmark Series® Panel for FG397000, FG397001, FG397088, FG397100, FG397200 |
| FG400400 | BSTON, CORL, ROCK | 50G Landmark Series® Panel for FG397500, FG397501 |
| FG400600 | CLR | 35G Clear Panel for FG397000, FG397001, FG397088, FG397100, FG397200 Containers |

When ordering products with **BOLD** color codes, please specify color code after the product number. Refer to the Standard Color Guide at the back of the catalog.

Landmark Series® Security Container

The solution for secure, effective, and affordable waste management for outdoor use.

- Complies with Department of Homeland Security Directive SD RAILPAX-04-01
- Provides total visibility of contents for improved security
- Constructed of durable, chemical-resistant, engineered polymer for easy cleaning and long life
- Locking dome top and bolt-down capability for added security
- Can liner retainer band for easy servicing
- No assembly required



ADA COMPLIANT



Polyliner retainer band for easy servicing.



Quick bag attachment and removal.



Panels are replaceable for extended life.

FG397589 and FG400700 are ideal for security-conscious facilities such as airports, train stations, sports facilities, government and office complexes, and convention centers.



FG397589BLA / FG400700BLA

Landmark Series® Security Container

| NO. | COLOR | DESCRIPTION | CAPACITY (GAL) | CAPACITY (LITERS) | U.S. DIMENSIONS | U.S. SHIP WT/CTN | METRIC DIMENSIONS | METRIC SHIP WT/CTN |
|----------|-------|---|----------------|-------------------|---------------------------|------------------|--------------------------|--------------------|
| FG397589 | BLA | Landmark Series® Security Container with Lock and Clear Panels | 50 | 189.3 | 26" sq x 46.5" h | 62.4 lb | 66 cm sq x 118.1 cm | 28.3 kg |
| FG400700 | CLR | Clear Replacement Panel for FG397500, FG397501, FG397589 Containers | N/A | N/A | 20.5" l x 34" w x 2.75" h | 17.7 lb | 52.1 cm x 86.4 cm x 7 cm | 8 kg |

Black (BLA), Clear (CLR)

Landmark Series® Gas Station/Store Front Containers

Style combined with functionality helps make gas islands and store fronts appealing and efficient for outdoor use.

- Landmark Series® models integrate waste management and window washing
- Insert personal messages and advertising with panel frame models (FG9W0200, FG9W0300)
- Standard bolt-down base for stability
- FG9W1400 provides an affordable funnel-top container for stadiums, retail, education, and hospitality environments



ADA COMPLIANT



FG9W0200BLA/FG9W0400BLA

Display your own custom insert to promote special messages right at the pump.



Dome Top FG9W0300BLA

Funnel Top FG9W0200BLA

Landmark Series® Gas Station/Store Front Containers

| NO. | COLOR | DESCRIPTION | CAPACITY (GAL) | CAPACITY (LITERS) | U.S. DIMENSIONS | U.S. SHIP WT/CTN | METRIC DIMENSIONS | METRIC SHIP WT/CTN |
|----------|-------|---|----------------|-------------------|-----------------|------------------|---------------------|--------------------|
| FG9W0000 | BLA | Landmark Series® Standard Funnel Top | 35 | 132.5 | 24" sq x 31" h | 28.2 lb | 61 cm sq x 78.7 cm | 12.8 kg |
| FG9W0100 | BLA | Landmark Series® Standard Dome Top | 35 | 132.5 | 24" sq x 43" h | 31.0 lb | 61 cm sq x 109.2 cm | 14.1 kg |
| FG9W0200 | BLA | Landmark Series® Funnel Top with Panel Frame and FG395800 Rigid Liner | 35 | 132.5 | 24" sq x 31" h | 30.2 lb | 61 cm sq x 78.7 cm | 13.7 kg |
| FG9W0300 | BLA | Landmark Series® Dome Top with Panel Frame and FG395800 Rigid Liner | 35 | 132.5 | 24" sq x 43" h | 33.0 lb | 61 cm sq x 109.2 cm | 15 kg |

Black (BLA)

Landmark Series® Accessory (Sold Separately)

| NO. | COLOR | DESCRIPTION | CAPACITY (GAL) | CAPACITY (LITERS) | U.S. DIMENSIONS | U.S. SHIP WT/CTN | METRIC DIMENSIONS | METRIC SHIP WT/CTN |
|----------|-------|---|----------------|-------------------|----------------------------|------------------|-----------------------------|--------------------|
| FG9W0400 | BLA | Window Wash Kit for FG9W0000, FG9W0100, FG9W0200, FG9W0300 Containers | N/A | N/A | 6.25" l x 16.25" w x 30" h | 8.2 lb | 15.9 cm x 41.3 cm x 76.2 cm | 3.7 kg |

Black (BLA)

For Additional Rigid Liner Options See Page 258



Ranger®

Ranger® waste containers feature Rubbermaid's famous durability, modern styling, and easy-to-service design for outdoor use.

- Designed for stadiums, parks, shopping malls, and other high-traffic areas
- Permanently attached hinged lid for easy emptying
- Pedestal base ring on 45-gallon and 65-gallon containers for stability and security (to be filled with sand or water by customer)



ADA COMPLIANT



APPROVED



FG917600BLA

FG917188BLA

FG843088BEIG



BETTER LINER RETENTION

Metal retainers keep can liners securely in place and eliminate knot tying.

LID OPTIONS

Ranger® 45- and 65-gallon containers are available in two styles:

2 HINGED DOORS for waste concealment and odor control.

4 OPENINGS for easier access in high-traffic areas.



WEIGHTED BASE OPTION

Optional Weighted Base (FG917700) is secured with screws and is available for 45- and 65-Gallon Ranger® containers for added stability. To be filled with sand or water by customer.



ENHANCED DURABILITY

Ranger® lids feature integrated, durable hinges that keep the lid securely attached to the container during emptying.



FG917500BEIG

Ranger®

| NO. | COLOR | DESCRIPTION | CAPACITY (GAL) | CAPACITY (LITERS) | U.S. DIMENSIONS | U.S. SHIP WT/CTN | METRIC DIMENSIONS | METRIC SHIP WT/CTN |
|-----------------------|-------------------|--|----------------|-------------------|----------------------|------------------|-----------------------|--------------------|
| FG843088 ¹ | BLA, BEIG | 35-Gallon Ranger® Container | 35 | 132.5 | 21.5" sq x 41" h | 30.4 lb | 54.6 cm sq x 104.1 cm | 13.8 kg |
| FG917188 ¹ | BLA, BEIG | 45-Gallon Ranger® Container with 2 Doors | 45 | 170.3 | 24.88" sq x 41.5" h | 42.5 lb | 63.2 cm sq x 105.4 cm | 19.3 kg |
| FG917388 ¹ | BLA, BEIG | 45-Gallon Ranger® Container with 4 Openings | 45 | 170.3 | 24.88" sq x 41.5" h | 37.9 lb | 63.2 cm sq x 105.4 cm | 17.2 kg |
| FG917500 ¹ | BLA, BEIG | 65-Gallon Ranger® Container with 2 Doors | 65 | 246.1 | 24.88" sq x 49.25" h | 51.1 lb | 63.2 cm sq x 125.1 cm | 23.2 kg |
| FG917600 ¹ | BLA, BEIG | 65-Gallon Ranger® Container with 4 Openings | 65 | 246.1 | 24.88" sq x 49.25" h | 46.5 lb | 63.2 cm sq x 125.1 cm | 21.1 kg |
| FG917700 ¹ | BLA, BEIG | Weighted Base Accessory for 45- and 65-Gallon Ranger® Containers | N/A | N/A | 24.5" sq x 6" h | 8.5 lb | 62.2 cm sq x 15.2 cm | 3.9 kg |
| FG395800 | GRAY, BEIG | Untouchable® Square Container (liner for FG917188/FG917388) | 35 | 132.5 | 19.5" sq x 27.63" h | 39.4 lb | 49.5 cm sq x 70.2 cm | 17.9 kg |
| FG395900 | GRAY, BEIG | Untouchable® Square Container (liner for FG917500/FG917600) | 50 | 189.3 | 19.5" sq x 34.25" h | 53.9 lb | 49.5 cm sq x 87 cm | 24.4 kg |
| FG356600 | GRAY | Rigid Liner for FG843088 | 24.5 | 93.4 L | 16.25" sq x 28.5" h | 33.3 lb | 41.3 cm sq x 72.4 cm | 15.1 kg |

Beige (BEIG), Black (BLA), Brown (BRN), Gray (GRAY) ¹ Provides hands-free use.

¹FM-Approved

UTILITY REFUSE AND RECYCLING

DECORATIVE REFUSE

CLEANING

MATERIAL HANDLING

WASHROOM

FOODSERVICE

ACCESSORIES & INDEX

Plaza®

Contemporary styling with side opening door for "no lift" unloading.

- The 35-gallon size is ideal for tight spaces and ships fully assembled
- Spring-loaded swing doors help contain odors
- Includes bolt-down capability
- Textured top model accommodates up to 15" x 20" (38.1 cm x 50.8 cm) trays
- Models FG396300, FG396400, and FG9P9000 are Factory Mutual (FM) approved when used with FG395800 and FG356300 Rigid Liners, respectively



FG396500* and FG9P9100* include a convenient ash tray insert.



FG396500BEIG*



FG9P9000BLA*
The 35-gallon size is ideal for tight spaces.



Plaza®

| NO. | COLOR | DESCRIPTION | CAPACITY (GAL) | CAPACITY (LITERS) | U.S. DIMENSIONS | U.S. SHIP WT/CTN | METRIC DIMENSIONS | METRIC SHIP WT/CTN |
|-----------------------|-----------------|--|----------------|-------------------|--------------------------------|------------------|------------------------------|--------------------|
| FG396300 ¹ | BLA, BEIG | Plaza® Container with Tray Top | 50 | 189.3 | 24.75" l x 25.25" w x 43" h | 81.0 lb | 62.9 cm x 64.1 cm x 109.2 cm | 36.7 kg |
| FG396400 ¹ | DGRN, BLA, BEIG | Plaza® Container | 50 | 189.3 | 24.75" l x 25.25" w x 42.13" h | 78.0 lb | 62.9 cm x 64.1 cm x 107 cm | 35.4 kg |
| FG396500* | BEIG | Plaza® Container with Ash Tray | 50 | 189.3 | 24.75" l x 25.25" w x 42.13" h | 78.0 lb | 62.9 cm x 64.1 cm x 107 cm | 35.4 kg |
| FG396873 | BLUE | Plaza® Bottle and Can Recycling Container | 50 | 189.3 L | 24.75" l x 25.25" w x 42.13" h | 78.0 lb | 62.9 cm x 64.1 cm x 107 cm | 35.4 kg |
| FG9P9000 ¹ | DGRN, BLA, BEIG | Plaza® Jr. Container | 35 | 132.5 | 21.4" l x 20.3" w x 41.1" h | 51.8 lb | 54.4 cm x 51.6 cm x 104.4 cm | 23.5 kg |
| FG9P9100* | BLA | Plaza® Jr. Container with Ash Tray Top | 35 | 132.5 | 21.4" l x 20.3" w x 41.1" h | 53.6 lb | 54.4 cm x 51.6 cm x 104.4 cm | 24.3 kg |
| FG356300 | BEIG | Rigid Liner for FG9P9000 and FG9P9100 Containers | 19 | 71.9 | 14.2" sq x 28" h | 27.0 lb | 36.1 cm sq x 71.1 cm | 12.2 kg |
| FG395800 ¹ | GRAY, BEIG | Untouchable® Square Container (liner for FG396500) | 35 | 132.5 | 19.5" sq x 27.63" h | 39.4 lb | 49.5 cm sq x 70.2 cm | 17.9 kg |

Beige (BEIG), Black (BLA), Dark Green (DGRN), Gray (GRAY)

*Does not include rigid liner. ¹ FM-Approved

UTILITY REFUSE AND RECYCLING

DECORATIVE REFUSE

CLEANING

MATERIAL HANDLING

WASHROOM

FOODSERVICE

ACCESSORIES & INDEX

Street Baskets

Designed to withstand constant use and harsh weather conditions. See-through design is ideal for city streets, parks, beaches, and other high-traffic areas.

- All-weather corrosion-resistant material
- Easy to transport and store
- Drain holes allow rain runoff
- Anchoring kits available to prevent tipping or theft



ADA COMPLIANT

Shown with optional Drum Top
FG1855BK



FGSBR52BK

Street Baskets

| NO. | COLOR | DESCRIPTION | CAPACITY (GAL) | CAPACITY (LITERS) | U.S. DIMENSIONS | U.S. SHIP WT/CTN | METRIC DIMENSIONS | METRIC SHIP WT/CTN |
|-----------|------------------|---------------|----------------|-------------------|-----------------|------------------|---------------------|--------------------|
| FGSBR52 | Galvanized Steel | Street Basket | 45 | 170.3 | 24" dia x 33" h | 41.0 lb | 61 cm dia x 83.8 cm | 18.6 kg |
| FGSBR52BK | Black | Street Basket | 45 | 170.3 | 24" dia x 33" h | 41.0 lb | 61 cm dia x 83.8 cm | 18.6 kg |

Steel Drum Tops

- Self-closing "PUSH" door
- Factory Mutual-approved fire-safe/self-extinguishing when used with a steel drum; complies with OSHA standards
- Includes thumbscrews for securing cover to drum

FG1855 Fits

- 55-Gal Steel Drum
- FGSBR52 (see *Street Baskets*, above)

FG2030 Fits

- 30-Gal Steel Drum



OSHA



FG2030BK



Steel Drum Tops (Sold Separately)

| NO. | COLOR | DESCRIPTION | CAPACITY (GAL) | CAPACITY (LITERS) | U.S. DIMENSIONS | U.S. SHIP WT/CTN | METRIC DIMENSIONS | METRIC SHIP WT/CTN |
|--------|-------------|--|----------------|-------------------|-----------------|------------------|-------------------|--------------------|
| FG1855 | BK, EGN, RD | Steel Drum Top for use w/ 55-Gal Steel Drum, FGSBR52 | N/A | N/A | 24.5" dia | 12.0 lb | 62.2 cm dia | 5.4 kg |
| FG2030 | BK, BR, EGN | Steel Drum Top for use w/ 30-Gal Steel Drum | N/A | N/A | 20" dia | 9.0 lb | 50.8 cm dia | 4.1 kg |

Black (BK), Brown (BR), Empire Green (EGN), Red (RD).

Glutton®

Large-capacity containers for indoor/outdoor use.

- Perfect for large crowds and high-traffic areas
- Withstands extreme weather and handling
- Hooded top available with and without doors
- Hold-down base can be filled with sand or water to provide added stability and security



ADA COMPLIANT

FG256B00BRN* / FG256V00BRN



FG256X00RED / FG256B00OWHT



FG256V00RED

Glutton®

| NO. | COLOR | DESCRIPTION | CAPACITY (GAL) | CAPACITY (LITERS) | U.S. DIMENSIONS | U.S. SHIP WT/CTN | METRIC DIMENSIONS | METRIC SHIP WT/CTN |
|-----------|-----------|---|----------------|-------------------|-------------------------------|------------------|-----------------------------|--------------------|
| FG256B00* | OWHT, BRN | Glutton® Container | 56 | 212 | 25.5" l x 22.75" w x 31.13" h | 67.3 lb | 64.8 cm x 57.8 cm x 79.1 cm | 30.5 kg |
| FG256V00 | RED, BRN | Glutton® Hooded Top without doors for FG256B00 Containers | N/A | N/A | 26.63" l x 23" w x 13" h | 14.2 lb | 67.6 cm x 58.4 cm x 33 cm | 6.4 kg |
| FG256X00 | RED, BRN | Glutton® Hooded Top with doors for FG256B00 Containers | N/A | N/A | 26.63" l x 23" w x 13" h | 19.2 lb | 67.6 cm x 58.4 cm x 33 cm | 8.7 kg |
| FG256K00 | GRAY | Rigid Liner for Glutton® Container | 42 | 159 | 23.25" l x 20.25" w x 29" h | 48.1 lb | 59.1 cm x 51.4 cm x 73.7 cm | 21.8 kg |

Brown (BRN), Off White (OWHT), Red (RED)

When ordering products with **BOLD** color codes, please specify color code after the product number. Refer to the Standard Color Guide at the back of the catalog.

UTILITY REFUSE AND RECYCLING

DECORATIVE REFUSE

CLEANING

MATERIAL HANDLING

WASHROOM

FOODSERVICE

ACCESSORIES & INDEX

**Smokers' Station®
Wall Mount**

Simply snuff out cigarettes on the extinguishing screen and drop into the receptacle.

- Recessed extinguishing screen prevents ashes from falling to the ground
- Heavy-gauge, hot-dipped galvanized, powder-coated, or stainless steel
- Mounting hardware included
- Keyed camlock helps prevent tampering



Easy emptying.



Optional surface mount and in-ground poles accommodate 1 or 2 models. FGSSSM / FGSSIG

Smokers' Station® Wall Mount

| NO. | COLOR | DESCRIPTION | CAPACITY (GAL) | CAPACITY (LITERS) | U.S. DIMENSIONS | U.S. SHIP WT/CTN | METRIC DIMENSIONS | METRIC SHIP WT/CTN |
|----------|-------|---|----------------|-------------------|-----------------|------------------|-----------------------|--------------------|
| FGR1012 | SS | Smokers' Station® Wall-Mount Urn w/ Keyed Cam Lock | N/A | N/A | 10" w x 12.5" h | 7.0 lb | 25.4 cm x 31.8 cm | 3.2 kg |
| FGR1012E | BK | Smokers' Station® Wall-Mount Urn w/ Keyed Cam Lock | N/A | N/A | 10" w x 12.5" h | 7.0 lb | 25.4 cm x 31.8 cm | 3.2 kg |
| FGSSSM | | Smokers' Station® Wall-Mount/Surface-Mount Pole w/ Hardware for FGR1012 | N/A | N/A | 2" dia x 51" h | 19.0 lb | 5.1 cm dia x 129.5 cm | 8.6 kg |
| FGSSIG | | Smokers' Station® Wall-Mount In-Ground Pole w/ Hardware for FGR1012 | N/A | N/A | 2" dia x 69" h | 21.0 lb | 5.1 cm dia x 175.3 cm | 9.5 kg |

Black (BK), Stainless Steel (SS)

Classic Smoking Urns and Accessories

Perfect in lobbies and hallways.

- Available with side opening for Class A refuse collection
- One-piece, wall-mounted smoking urn is easy to empty and clean



Classic Smoking Urns and Accessories

| NO. | COLOR | DESCRIPTION | CAPACITY (GAL) | CAPACITY (LITERS) | U.S. DIMENSIONS | U.S. SHIP WT/CTN | METRIC DIMENSIONS | METRIC SHIP WT/CTN |
|----------|-------|--|----------------|-------------------|---------------------|------------------|-----------------------|--------------------|
| FG258500 | BLA | Classic Smoking Urn with Metal Ash Tray Top | N/A | N/A | 11.5" dia x 19.5" h | 8.4 lb | 29.2 cm dia x 49.5 cm | 3.8 kg |
| FG258600 | BLA | Classic Smoking Urn, Ash/Trash w/ Metal Ash Tray Top and Metal Liner | N/A | N/A | 12.5" dia x 19.5" h | 9.7 lb | 31.8 cm dia x 49.5 cm | 4.4 kg |

Black (BLA)

Ash/Trash Containers

Combines waste and smoking management for increased efficiency.

CLASSIC CONTAINERS

- Ash tray can be permanently attached or left unattached for easy emptying
- Retainer hardware secures and conceals can liners
- Doors on both sides provide easy access for trash disposal

FG818588BEIG

FG818088BRN



FG818488BEIG



ADA COMPLIANT

Ash/Trash Classic Containers

| NO. | COLOR | DESCRIPTION | CAPACITY (GAL) | CAPACITY (LITERS) | U.S. DIMENSIONS | U.S. SHIP WT/CTN | METRIC DIMENSIONS | METRIC SHIP WT/CTN |
|-----------|------------------|---|----------------|-------------------|----------------------|------------------|------------------------|--------------------|
| FG818088 | BRN, BEIG | Ash/Trash Classic Container with Doors | 25 | 94.6 | 18" dia x 42.25" h | 27.7 lb | 45.7 cm dia x 107.3 cm | 12.6 kg |
| FG818288* | BEIG | Ash/Trash Classic Container without Doors | 25 | 94.6 | 18" dia x 42.25" h | 26.0 lb | 45.7 cm dia x 107.3 cm | 11.8 kg |
| FG818488 | BEIG | Ash/Trash Classic Container with Doors | 15 | 56.8 | 15.5" dia x 38" h | 21.3 lb | 39.4 cm dia x 96.5 cm | 9.7 kg |
| FG818588* | BEIG | Ash/Trash Classic Container without Doors | 15 | 56.8 | 12.5" dia x 38" h | 19.6 lb | 31.8 cm dia x 96.5 cm | 8.9 kg |
| FG355000 | GRAY | Rigid Liner for FG818488, FG818588 Containers | 12.1 | 45.9 | 12" dia x 27.25" h | 16.2 lb | 30.5 cm dia x 69.2 cm | 7.3 kg |
| FG355200 | GRAY | Rigid Liner with Rim for FG818088 and FG818288 Containers | 22 | 83.3 | 14.5" dia x 30.13" h | 26.9 lb | 36.8 cm dia x 76.5 cm | 12.2 kg |

Beige (BEIG), Brown (BRN), Gray (GRAY) *Provides hands-free use.

GroundsKeeper® Receptacles

Classic, all-weather solution to an unsightly environmental problem.

- Hygienic, easy-to-service steel canister
- Restricted opening shields waste from view, weather, and flow of oxygen
- Galvanized steel inner canister holds large quantities of cigarette waste
- Steel base plate adds stability and discourages theft
- Optional Weight Ring (FG628400) available for Safety Cones for added stability

FG257088BEIG



FG9W3000BLA

FG9W3000's Tuscan style combines clean good looks with easy maintenance.

- Design blends with many styles
- Stainless steel snuff plate
- Anchor holes for added security

GroundsKeeper®

| NO. | COLOR | DESCRIPTION | CAPACITY (GAL) | CAPACITY (LITERS) | U.S. DIMENSIONS | U.S. SHIP WT/CTN | METRIC DIMENSIONS | METRIC SHIP WT/CTN |
|-----------|-----------------------|---|----------------|-------------------|--------------------------|------------------|----------------------------|--------------------|
| FG257088* | BRN, BLA, BEIG | GroundsKeeper® Smoking Management Receptacle | N/A | N/A | 12.25" sq x 39.4" h | 15.5 lb | 31.1 cm sq x 100.1 cm | 7 kg |
| FG628400 | BLA | Weight Ring | N/A | N/A | 12.5" l x 12.5" w x 1" h | 10.0 lb | 31.8 cm x 31.8 cm x 2.5 cm | 4.5 kg |
| FG9W2900 | 0000 | Security Kit for GroundsKeeper® Tuscan Receptacle | N/A | N/A | N/A | 2.8 lb | N/A | 1.3 kg |
| FG9W3000 | BLA, SSTON | GroundsKeeper® Tuscan Receptacle | N/A | N/A | 13" sq x 38.38" h | 15.4 lb | 33 cm sq x 97.5 cm | 7 kg |

Black (BLA), Beige (BEIG), Brown (BRN), Sandstone (SSTON), No Color (0000)

UTILITY REFUSE AND RECYCLING

DECORATIVE REFUSE

CLEANING

MATERIAL HANDLING

WASHROOM

FOODSERVICE

ACCESSORIES & INDEX

Infinity™ Smoking Management Solutions

Sophisticated styling and all-metal construction for attractive and efficient smoking litter management.

- High-capacity receptacles for heavy traffic areas
- Stainless steel snuff plates
- Weighted bases and bolt-down options for added stability outdoors
- 360° disposal area
- Domed tops for weather resistance
- Integrated padlock tabs provide security against tampering and theft



CSFM



Recessed extinguishing screen snuffs small butts and avoids smoldering.



Curved cap prevents items or trash being placed on the top and water from entering the canister.



Integrated padlock tabs provide security against tampering and theft.



Holes to bolt to ground help the container remain stable and add security.



FG9W3300ATPWTR



FG9W3400AGBRNZ

| NO. | COLOR | DESCRIPTION | CAPACITY (GAL) | CAPACITY (LITERS) | CIGARETTE COUNT | U.S. DIMENSIONS | U.S. SHIP WT/CTN | METRIC DIMENSIONS | METRIC SHIP WT/CTN |
|----------|---------------------|--|----------------|-------------------|-----------------|--------------------|------------------|--------------------|--------------------|
| FG9W3100 | SSBLA | Infinity™ Base-Mount Smoking Receptacle | 1.3 | 4.9 | 1,500* | 15.5" w x 39.63" h | 23.3 lb | 39.4 cm x 100.7 cm | 10.6 kg |
| FG9W3200 | SSBLA | Infinity™ Wall-Mount Smoking Receptacle | 0.6 | 2.3 | 700* | 11.63" w x 18" h | 12.0 lb | 29.5 cm x 45.7 cm | 5.4 kg |
| FG9W3300 | BLA, ATPWTR, AGBRNZ | Infinity™ Traditional Smoking Receptacle | 4.1 | 15.5 | 5,000* | 13" w x 39" h | 23.8 lb | 33 cm x 99.1 cm | 10.8 kg |
| FG9W3400 | BLA, ATPWTR, AGBRNZ | Infinity™ Ultra-High-Capacity Smoking Receptacle | 6.7 | 25.4 | 8,000* | 15.5" w x 41.5" h | 32.5 lb | 39.4 cm x 105.4 cm | 14.7 kg |

Aged Bronze (AGBRNZ), Antique Pewter (ATPWTR), Black (BLA), Stainless Steel/Black Top (SSBLA)

*Based on estimated 1,200 cigarette butts per gallon.

UTILITY REFUSE AND RECYCLING

DECORATIVE REFUSE

CLEANING

MATERIAL HANDLING

WASHROOM

FOODSERVICE

ACCESSORIES & INDEX



Metropolitan Smokers' Station

Metropolitan is a stylish all-metal, high-capacity smokers' station.



USER-FRIENDLY
Stainless steel snuff plates on both sides of unit.

WEATHERPROOF FINISH
Long-lasting Uni-Koat® powder-coated finish.

AESTHETIC AND DURABLE
All-metal construction in a slim, contemporary design.

FGR93400SM

FGR93400BK



EASY TO EMPTY
Hinged lid flips open to provide complete access to the 1.6-gal galvanized liner. Simply lift out liner, discard waste, and reinsert.



WEIGHTED BASE AND BOLT-DOWN CAPABILITY
Base features holes for standard 3/8" lag or concrete bolts (not included) and is weighted for stability.



SECURITY FEATURES
Integrated keyed cam lock secures lid against tampering and helps reduce replacement costs.

| NO. | COLOR | DESCRIPTION | CAPACITY (GAL) | CAPACITY (LITERS) | U.S. DIMENSIONS | U.S. SHIP WT/CTN | METRIC DIMENSIONS | METRIC SHIP WT/CTN |
|----------------------------------|---------------|-------------------------------|---|-------------------|---------------------|------------------|------------------------|--------------------|
| FGR93400 | BK, SM | Metropolitan Smokers' Station | 1.6 gallons Approx. 1,800 cigarettes | 6.06 liters | 16.8" dia x 42.8" h | 39 lb | 42.7 cm dia x 108.7 cm | 17.7 kg |
| Black (BK), Silver Metallic (SM) | | | | | | | | |

When ordering products with **BOLD** color codes, please specify color code after the product number. Refer to the Standard Color Guide at the back of the catalog.

UTILITY REFUSE AND RECYCLING

DECORATIVE REFUSE

CLEANING

MATERIAL HANDLING

WASHROOM

FOODSERVICE

ACCESSORIES & INDEX

Smokers' Pole

Simple, space-saving solution for controlling smokers' waste.

- Easy-to-empty design requires no tools and minimal bending
- Weather-resistant, powder-coated, fire-safe aluminum
- Recessed extinguishing screen



ADA COMPLIANT



1. Remove top using quick-release push-button.



2. Detach unit at midpoint, using quick-release push-button.



3. Empty contents.



FGR1SM

FGR1BK

| NO. | COLOR | DESCRIPTION | CAPACITY (GAL) | CAPACITY (LITERS) | U.S. DIMENSIONS | U.S. SHIP WT/CTN | METRIC DIMENSIONS | METRIC SHIP WT/CTN |
|------|--------|---------------|----------------|-------------------|---------------------------|------------------|----------------------------------|--------------------|
| FGR1 | BK, SM | Smokers' Pole | N/A | N/A | 4" dia x 12.75" w x 41" h | 24.0 lb | 10.2 cm dia x 32.4 cm x 104.1 cm | 10.9 kg |

Black (BK), Silver Metallic (SM)

Aladdin Smokers' Station®

Weather-resistant, fire-safe steel construction will not burn.

- Factory Mutual-approved fire-safe/self-extinguishing
- Oxygen-restricting design quickly extinguishes cigarettes
- Nylon base pads prevent damage to surface and base
- Stainless steel latches and nickel-plated brass chain
- Optional anchoring kits available



ADA COMPLIANT



FGR1639EHGR

FGR1639EHZ

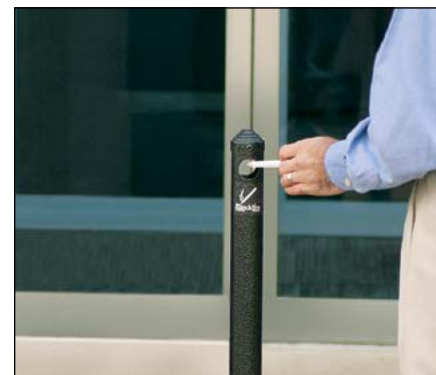

Stainless steel latches require no tedious, time-consuming alignment to fasten. Forms a tight-fitting seal.



Top and base connected with nickel-plated brass chain to deter theft.

Aladdin Smokers' Station®

| NO. | COLOR | DESCRIPTION | CAPACITY (GAL) | CAPACITY (LITERS) | U.S. DIMENSIONS | U.S. SHIP WT/CTN | METRIC DIMENSIONS | METRIC SHIP WT/CTN |
|----------|----------|---------------------------|----------------|-------------------|--------------------|------------------|-----------------------|--------------------|
| FGR1639E | HBZ, HGR | Aladdin Smokers' Station® | 41 | 170 | 16" dia x 38.75" h | 22.0 lb | 40.6 cm dia x 98.4 cm | 10 kg |

Hammertone Bronze (HBZ), Hammertone Charcoal (HGR)



This symbol, positioned with Decorative Receptacle refuse containers, indicates post-consumer recycled content (30% for steel, 70% for aluminum).



Waste Container Accessories



SAND
FGB25/FGS25

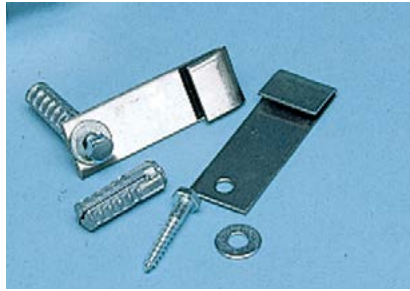

ANCHORING KIT
See chart.



Find replacement liners on page 258 or call your Rubbermaid Commercial Products' Sales Representative.

Waste Container Smoking Accessories

| NO. | DESCRIPTION | FOR USE WITH: |
|-------|-----------------------------------|---------------|
| FGB25 | Black Sand, five 5-lb Bags | All Sand Urns |
| FGS25 | White Silica Sand, five 5-lb Bags | All Sand Urns |

Waste Container Anchoring Kits/Accessories

| NO. | DESCRIPTION | FOR USE WITH: |
|---------|--------------------------|----------------------------|
| FGKR12 | Anchoring Kit | FGMT12, FGMT22, FGMT32 |
| FGKR52C | Anchoring Kit (concrete) | FGSBR52 |
| FGAB1 | Anchoring Bolt | FGR12, FGR14, FGR40, FGR41 |

UTILITY REFUSE
AND RECYCLING

DECORATIVE REFUSE

CLEANING

MATERIAL HANDLING

WASHROOM

FOODSERVICE

ACCESSORIES
& INDEX



FGSH12EPLSM



UTILITY REFUSE
AND RECYCLING

DECORATIVE REFUSE

CLEANING

MATERIAL HANDLING

WASHROOM

FOODSERVICE

ACCESSORIES
& INDEX



CLEANING



1928756

HYGEN™ MICROFIBER

Why HYGEN™?74

Disposable Microfiber System75

HYGEN™ Microfiber Cloths76

HYGEN™ Flexi-Frame77

HYGEN™ Single-Sided Mops78

Microfiber Damp Mops79

HYGEN™ Quick-Connect
Single-Sided Frames80

HYGEN™ Quick-Connect
Equipment81

HYGEN™ Microfiber Buckets.....82

PULSE™ Microfiber Floor
Cleaning System with Single-Sided Frame83

PULSE™ Microfiber Floor Cleaning
System with Double-Sided Frame84

Double-Sided Microfiber Mops84

Double-Sided Frame85

HYGEN™ Microfiber Flexible
Dusting Wand.....86

HYGEN™ Microfiber Mitts.....86

HYGEN™ MICROFIBER
HYGEN™ Sanitizer-Safe Microfiber Cloths87

HYGEN™ Microfiber Kit
with Charging Bucket87

MICROFIBER
Light Commercial Microfiber Cloths and Mops.....88

FLOW™ Finishing Systems.....89

Microfiber Flat Mop Finishing90

Microfiber Finish System.....90

WAVEBRAKE® MOPPING SYSTEMS

WaveBrake® Buckets and Wringers95

WaveBrake® Institutional Bucket and Wringer.....96

WaveBrake® Bucket and Casters96

Tandem™ 31-Qt Bucket and Wringer Combo.....97

WaveBrake® Wringers.....97

WaveBrake® Dirty Water Buckets97

WET MOPS

Wet Mop Selection Guide98

MAXIMIZER™ WET MOPS

Maximizer™ Microfiber Blend Mops102

Maximizer™ Blend Mops102

PREMIUM WET MOPS

Web Foot® Mops103

Web Foot® Microfiber Tube Mops103

Web Foot® Microfiber String Mops103

Web Foot® Blend Shrinkless® Mops104

Web Foot® Blend Scrubbing Wet Mops.....104

Web Foot® Blend Mops104

Web Foot® Finish Mops105

Swinger Loop® Shrinkless® Wet Mops.....105

Swinger Loop® Wet Mops.....105

STANDARD WET MOPS

Swinger Loop® Finish Mops107

Super Stitch® Rayon Mops107

Super Stitch® Cotton Scrubbing Wet Mop107

Super Stitch® Cotton Mop108

Super Stitch® Finish Mops.....108

Super Stitch® Blend Scrubbing Wet Mop.....108

Super Stitch® Blend Mops109

Universal Headband Blue Blend Mops109

Universal Headband Rayon Mops109

Universal Headband Cotton Mops110

ECONOMY WET MOPS

Dura Pro Blend Mops.....110

Dura Pro Rayon Mops.....110

Disposable Wet Mop111

Dura Pro Cotton Mops111

Value Pro Cut-End Cotton
and Rayon Wet Mops112

Bolt-On Cut-End Blend Mops112

Bolt-On Cut-End Rayon Mops112

Bolt-On Cut-End Cotton Mops113

8-Ply Cut-End Cotton Mops113

SPECIALTY AND FINISH WET MOPS

Synthetic Blend Mops113

Clean Room Maintenance Mops114

Rough-Floor Wet Mops.....114

Nylon Finish Mops.....114

WET MOP HANDLES

Wet Mop Handles.....115

Adjustable Mop Handles116

Laundry Net116

MOPPING ACCESSORIES

BRUTE® Buckets116

Pail and Mop Strainer Combination117

Steel Sponge Mop/Double Pails117

Dust Mop Selection Guide119

Microfiber Looped-End Dust Mops.....119

Twisted-Loop Dust Mops120

Trapper® Dust Mops.....121

Kut-A-Way® Dust Mops.....121



FG758088YEL

| | |
|--|-----|
| Disposable Cut-End Blended Dust Mops..... | 121 |
| Disposable Cut-End Cotton Dust Mops..... | 122 |
| Snap-On Wire Dust Mop Frames..... | 122 |
| Snap-On Dust Mop Handles..... | 122 |
| Cut-to-Length Dust Mops..... | 123 |
| Wedge Mop System..... | 123 |
| MAXIMIZER™ Dust Mop with EZ Access Scraper..... | 124 |
| MAXIMIZER™ Overhead Cleaning Tool..... | 124 |
| DUST MOP FRAMES AND HANDLES | |
| Overhead Dusting Tools..... | 125 |
| Flexible-Head Overhead Dusting Tools..... | 125 |
| Lambswool Duster..... | 125 |
| CARPET BONNETS | |
| Carpet Bonnets..... | 125 |
| BROOMS | |
| Broom Construction..... | 126 |
| Anti-Twist Threaded Push Brooms..... | 127 |
| Assembled Push Brooms..... | 127 |
| MAXIMIZER™ Push-to-Center Broom..... | 128 |
| Street Sweeps..... | 128 |
| Broom Handles..... | 128 |
| Angle Brooms..... | 129 |
| Corn Brooms..... | 129 |
| Lobby Pro® Upright Dust Pans..... | 129 |
| BRUSHES | |
| Brush Construction Guide..... | 130 |
| Plastic-Handle Utility Brushes..... | 130 |

| | |
|---|-----|
| CLEANING BRUSHES | |
| Truck and Wash Brush and Floor/Deck Scrub..... | 131 |
| Wire Brushes..... | 131 |
| Scrub Brushes..... | 131 |
| Toilet Bowl Brushes and Holders..... | 132 |
| Wall Washer Kit..... | 132 |
| Counter Brushes/Whisk Broom/ Heavy-Duty Dust Pans..... | 132 |
| Floor Squeegees..... | 133 |

| | |
|--|-----|
| CLEANING TOOLS | |
| Lobby Pro® Wet/Dry Spill Pan..... | 133 |
| MAXIMIZER™ Wet/Dry Debris Pan..... | 134 |
| MAXIMIZER™ Broomgee™..... | 134 |
| MAXIMIZER™ Heavy Duty Debris Pan..... | 134 |
| MAXIMIZER™ 3-in-1 Floor Prep Tool..... | 134 |
| MAXIMIZER™ Quick Change Cleaning Tools..... | 135 |

| | |
|--|-----|
| CLEANING CARTS | |
| High-Capacity Janitorial Cleaning Cart with Bins..... | 138 |
| High-Security Janitorial Cleaning Carts..... | 138 |
| High-Capacity Janitorial Cleaning Carts..... | 139 |
| Traditional Janitorial Cleaning Carts..... | 139 |

| | |
|---|-----|
| CLEANING CART ACCESSORIES | |
| Cleaning, Deluxe Paneled, and Compact Housekeeping Cart Accessories..... | 140 |

| | |
|---|-----|
| TRADITIONAL HOUSEKEEPING CARTS | |
| Executive Traditional Housekeeping Carts..... | 142 |
| Housekeeping Cart Bumper Kits..... | 143 |
| Housekeeping Cart Accessories..... | 144 |

| | |
|------------------------------------|-----|
| QUICK CARTS | |
| Executive Quick Carts..... | 145 |
| Executive Quick Cart – Large..... | 146 |
| Executive Quick Cart – Medium..... | 146 |
| Executive Quick Cart – Small..... | 146 |

| | |
|--|-----|
| MECHANICAL SWEEPERS | |
| Mechanical Sweeper Selection Guide..... | 147 |
| Executive Single-Action Basic Mechanical Sweeper..... | 147 |
| Executive Dual-Action Bristle Mechanical Sweeper..... | 147 |
| Executive Dual-Action Brushless Mechanical Sweeper..... | 147 |

| | |
|---------------------------------------|-----|
| TOOLS AND ACCESSORIES | |
| Closet Organizer and Tool Holder..... | 148 |
| Ironing Organizers..... | 148 |
| Mobile Two-Step Stepstool..... | 148 |
| Executive Spray Bottle, 32-Oz..... | 149 |
| Deluxe Carry Caddy..... | 149 |

LOOK FOR THE SPECIALLY MARKED EXECUTIVE SERIES™ PRODUCTS.

CLEANING

HYGEN

WHY HYGEN™?

KILLING MICROBES DOESN'T MAKE THEM DISAPPEAR.

Traditional disposable products lack scrubbing power, streak and smear, and cannot remove microbes, leaving behind a food source for live pathogens. HYGEN™ Disposable Microfiber eliminates the food source and combines superior microfiber with built-in scrubber technology, in a disposable application, to prevent cross-transmission and reduce the risk of healthcare-associated infections.

Built-In Scrubbers

Innovative microbe-removing technology is complemented with built-in zigzag scrubbers to effectively remove dirt without streaking or smearing.

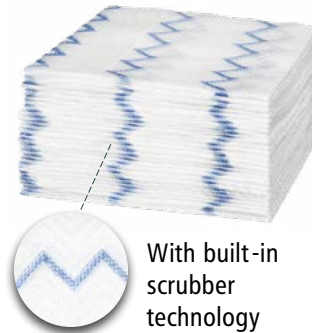

With built-in scrubber technology

REMOVES
99.9%
OF MICROORGANISMS,
INCLUDING C. DIFF.*
**STOP THE CHAIN
OF INFECTION.**

Microbe removal is a critical step in preventing infection. Removing dead microbes eliminates the food source for live pathogens.

RECOMMENDED HEALTHCARE APPLICATIONS

| | |
|-------------------------|---|
| Occupied Patient Room | HYGEN™ Disposable Microfiber Cloths |
| Discharged Patient Room | HYGEN™ Disposable Microfiber Cloths and Mop |
| OR Terminal | HYGEN™ Disposable Microfiber Cloths |
| ER | HYGEN™ Disposable Microfiber Cloths and Mop |
| ICU / Isolation Room | HYGEN™ Disposable Microfiber Cloths and Mop |
| Nurses' Station | HYGEN™ Disposable Microfiber Cloths |
| MRI / X-ray Station | HYGEN™ Disposable Microfiber Cloths and Mop |

*Based on third-party testing with water only. The product can be used with a wide array of cleaning solutions. EPA EST. 90650-NC-001

DISPOSABLE MICROFIBER SYSTEM

The HYGEN™ Disposable Microfiber System is the solution for optimizing infection prevention, ensuring environmental hygiene and improving productivity.

99.9% Microbe Removal, Including C. diff*

- Proven 99.9% microbe removal claim
- Helps stop the chain of infection
- Eliminates food source for live pathogens

Superior Cleaning Performance

- Microfiber cleaning with built-in scrubbing power
- Streak-free cleaning for mirrors, glass, and stainless steel
- Effectively removes dirt without smearing

Versatile Cleaning

- Compatible with bleach and quat
- Ideal for dusting and wet cleaning
- Convenient charging system and compatible with existing tools



| NO. | DESCRIPTION | SIZE | COLOR | CASE PACK SIZE | QUANTITY PER CASE |
|---------|---|--------------|-------|----------------|-------------------|
| 1928756 | HYGEN™ Disposable Microfiber Cloth Starter Kit | 8" x 10" | WH00 | 1 | 160 Cloths + Tub |
| 1928023 | HYGEN™ Disposable Microfiber Cloth Refill Pack | 8" x 10" | WH00 | 1 | 640 Cloths |
| 1928024 | HYGEN™ Disposable Microfiber Cloth Bulk Pack | 8" x 10" | WH00 | 1 | 960 Cloths |
| 1822351 | HYGEN™ Disposable Microfiber Cloth Charging Tub | 7.3" x 7.75" | WH00 | 1 | 4 Tubs |
| 1822352 | HYGEN™ Disposable Microfiber Mop Pad | 18" x 5.5" | WH00 | 1 | 150 Mops |

*Based on third-party testing with water only. The product can be used with a wide array of cleaning solutions. EPA EST. 90650-NC-001



HEALTHCARE

- Isolation room
- Discharged patient room
- Emergency room
- Intensive care unit



OFFICE BUILDINGS

- Lobby/reception area
- Conference room
- Break area
- Public restroom



SCHOOLS

- Classroom
- Administrative office
- Public restroom



RETAIL

- Retail fashion outlet
- Beauty salon



FOODSERVICE

- Front of house



HOSPITALITY

- Spa
- Health club
- Fitness studio

HYGEN™ Microfiber Cloths

HYGEN™ cloths with built-in scrubbers deliver debris removal when dust cleaning, and better liquid absorption for damp cleaning. When used with the 8-sided fold method, HYGEN™ cloths effectively clean more surface area. Double-finished edges and high-quality stitching retain shape and provide added durability.

- HYGEN™ cloths remove 99.9% of microbes including C. diff, with water alone
- HYGEN™ cloths are color-coded to assist in cleaning by area or task and help reduce cross-transmission
- Patented zig-zag scrubbers make cleanup quick and easy



REDUCE CROSS-TRANSMISSION

HYGEN™ Microfiber Cloths are color-coded to assist in cleaning by area or task and help reduce cross-transmission.



EXECUTIVE SERIES™ MICROFIBER CLOTHS

Glass/mirror cloths for scratch-free cleaning.



EXECUTIVE SERIES™
1867398

PROVEN TO REMOVE
99.9%
OF MICROBES



MICROFIBER CLOTHS

Yellow, red, green, and blue cloths for cleaning by area or task.

BLEACH-
SAFE
in hot & cold water

Certified to tolerate CDC hot and cold water laundering requirements*

DURABLE UP TO
500

laundings**
(up to 200 with bleach)

| NO. | COLOR | DESCRIPTION | U.S. DIMENSIONS | U.S. SHIP WT/CTN | METRIC DIMENSIONS | METRIC SHIP WT/CTN | PACK |
|-----------|-------------------------|---|-----------------|------------------|-------------------|--------------------|------|
| FGQ61000 | YL00 | HYGEN™ Microfiber Bathroom Cloth (Yellow) | 16" l x 16" w | 0.6 lb | 40.6 cm x 40.6 cm | 0.3 kg | 12 |
| FGQ62000 | GR00, RD00, BL00 | HYGEN™ Microfiber General-Purpose Cloth (Green, Red, or Blue) | 16" l x 16" w | 0.65 lb | 40.6 cm x 40.6 cm | 0.29 kg | 12 |
| FGQ62006 | GR00 | HYGEN™ Microfiber General-Purpose Cloth (Green) | 16" l x 16" w | 0.8 lb | 40.6 cm x 40.6 cm | 0.4 kg | 6 |
| FGQ63000 | BL00 | HYGEN™ Microfiber Glass/Mirror Cloth (Blue) | 16" l x 16" w | 1.8 lb | 40.6 cm x 40.6 cm | 0.8 kg | 12 |
| ⑤ 1867398 | GRAY | Executive 16" HYGEN™ Glass Microfiber Cloth (Gray) | 16" l x 16" w | 1.8 lb | 40.6 cm x 40.6 cm | 0.8 kg | 12 |
| FGQ63006 | BL00 | HYGEN™ Microfiber Glass/Mirror Cloth (Blue) | 16" l x 16" w | 0.5 lb | 40.6 cm x 40.6 cm | 0.2 kg | 6 |
| FGQ64000 | GR00 | HYGEN™ Microfiber XL General-Purpose Cloth (Green) | 20" l x 20" w | 1.4 lb | 50.8 cm x 50.8 cm | 0.6 kg | 12 |

* Always use cleaning chemicals or disinfectants as directed by your facility manager

** Based on internal testing without bleach

UTILITY REFUSE AND RECYCLING

DECORATIVE REFUSE

CLEANING

MATERIAL HANDLING

WASHROOM

FOODSERVICE

ACCESSORIES & INDEX



HYGEN™ Flexi-Frame

Clean faster and more effectively.

- Frame conforms to curved surfaces for better pickup of dirt and debris
- Frame flexible to clean both contoured and flat surfaces
- The proprietary material withstands harsh chemicals, including bleach and peroxide



EXECUTIVE SERIES™
1867396

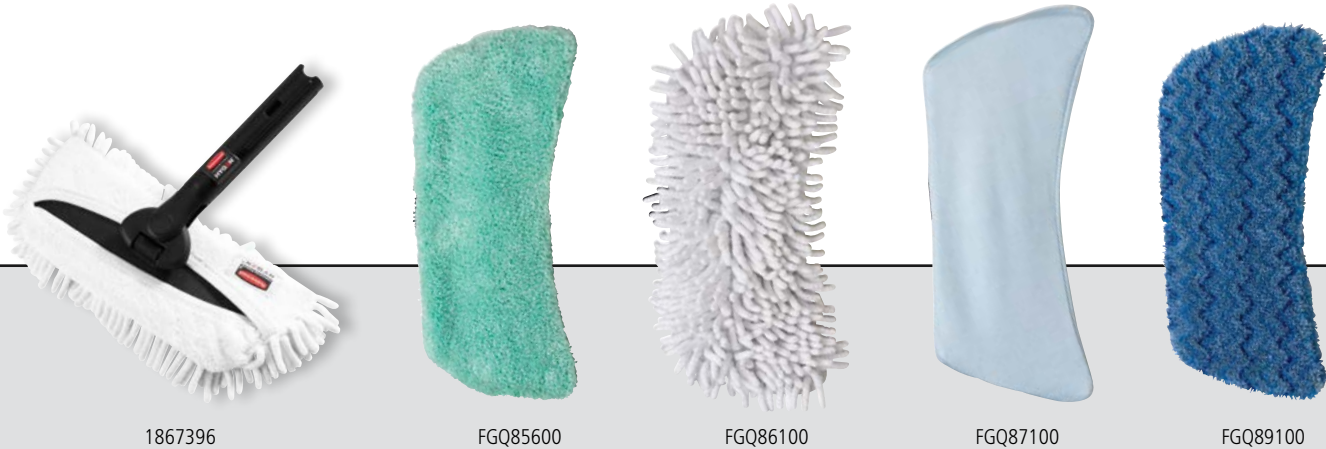

1867396

FGQ85600

FGQ86100

FGQ87100

FGQ89100

| NO. | COLOR | DESCRIPTION | U.S. DIMENSIONS | U.S. SHIP WT/CTN | METRIC DIMENSIONS | METRIC SHIP WT/CTN | PACK |
|----------|-------|---|---------------------------|------------------|----------------------------|--------------------|------|
| FGQ85500 | BK00 | 11" HYGEN™ Microfiber Flexi-Frame | 13.1" l x 5.4" w x 0.8" h | 4.9 lb | 33.3 cm x 13.7 cm x 2 cm | 2.2 kg | 6 |
| 1867396 | BLACK | Executive 11" HYGEN™ Microfiber Flexible Flat Mop Frame, Single-Sided | 13.1" l x 5.4" w x 0.8" h | 4.9 lb | 33.3 cm x 13.7 cm x 2 cm | 2.2 kg | 6 |
| FGQ85600 | GR00 | HYGEN™ Microfiber Flexi-Frame Duster Cover | 8.9" l x 5.9" w x 0.3" h | 1.4 lb | 22.6 cm x 15 cm x 0.8 cm | 0.6 kg | 12 |
| FGQ86100 | WH00 | 11" HYGEN™ Microfiber Flexi-Frame Hi-Pile Cover | 8.9" l x 5.9" w x 0.9" h | 2.2 lb | 22.6 cm x 15 cm x 2.3 cm | 1.0 kg | 12 |
| FGQ87100 | BL00 | HYGEN™ Microfiber Flexi-Frame Glass Cover | 8.9" l x 5.9" w x 0.9" h | 1.1 lb | 22.6 cm x 15 cm x 2.3 cm | 0.5 kg | 12 |
| FGQ88100 | YL00 | HYGEN™ Microfiber Flexi-Frame Tub and Tile Cover | 8.3" l x 8.3" w x 0.3" h | 1.6 lb | 21.1 cm x 21.1 cm x 0.8 cm | 0.7 kg | 12 |
| FGQ89100 | BL00 | HYGEN™ Microfiber Flexi-Frame Damp Mop Cover | 8.3" l x 8.3" w x 0.3" h | 1.8 lb | 21.1 cm x 21.1 cm x 0.8 cm | 0.8 kg | 12 |

HYGEN™ Single-Sided Mops

Microfiber Dust Mops

Dust removal is critical to preventing the spread of infection.

- Split-blended HYGEN™ dust mops trap and lock away dust, dirt, and debris
- Dust mopping prior to damp mopping reduces floor hazing and best maintains floor finish
- Fringed dust mops improve debris pickup
- Industry leading hook and loop backing won't degrade during commercial laundering



50% more surface area
 HYGEN™ fringed dust mops provide significantly greater surface area versus nonfringed mops for faster cleaning. Available in widths up to 60".



FGQ41200



FGQ41800



EXECUTIVE SERIES™
 1867397

BLEACH-SAFE
 in hot & cold water

Certified to tolerate CDC hot and cold water laundering requirements.*

DURABLE UP TO 500

laundering**
 (up to 200 with bleach)

Microfiber Dust Mops

| NO. | COLOR | DESCRIPTION | U.S. DIMENSIONS | U.S. SHIP WT/CTN | METRIC DIMENSIONS | METRIC SHIP WT/CTN | PACK |
|----------|-------------------|--|---------------------------|------------------|-----------------------------|--------------------|------|
| FGQ41200 | GR00, WH00 | 18" (45.7 cm) HYGEN™ Microfiber Room Dust Mop | 21.0" l x 5.2" w x 0.5" h | 1.4 lb | 53.3 cm x 13.2 cm x 1.3 cm | 0.6 kg | 12 |
| FGQ42400 | GR00 | 24" (61 cm) HYGEN™ Microfiber Hall Dust Mop | 27.5" l x 5.2" w x 0.5" h | 2.5 lb | 69.9 cm x 13.2 cm x 1.3 cm | 1.1 kg | 12 |
| FGQ43600 | GR00 | 36" (91.4 cm) HYGEN™ Microfiber Hall Dust Mop | 39.5" l x 5.2" w x 0.5" h | 3.3 lb | 100.3 cm x 13.2 cm x 1.3 cm | 1.5 kg | 12 |
| FGQ44800 | GR00 | 48" (121.9 cm) HYGEN™ Microfiber Hall Dust Mop | 51.5" l x 5.2" w x 0.5" h | 5.5 lb | 130.8 cm x 13.2 cm x 1.3 cm | 2.5 kg | 12 |

Microfiber Fringed Dust Mops

| NO. | COLOR | DESCRIPTION | U.S. DIMENSIONS | U.S. SHIP WT/CTN | METRIC DIMENSIONS | METRIC SHIP WT/CTN | PACK |
|----------|-------------|---|---------------------------|------------------|-----------------------------|--------------------|------|
| FGQ41800 | GR00 | 18" (45.7 cm) HYGEN™ Microfiber Fringed Dust Mop | 21.0" l x 9.0" w x 0.5" h | 3.2 lb | 53.3 cm x 22.9 cm x 1.3 cm | 1.5 kg | 6 |
| 1867397 | GRAY | Executive HYGEN™ Multipurpose Microfiber PULSE™ Dust Flat Mop, Single-Sided | 21.0" l x 9.0" w x 0.5" h | 3.2 lb | 53.3 cm x 22.9 cm x 1.3 cm | 1.5 kg | 6 |
| FGQ42600 | GR00 | 24" (61 cm) HYGEN™ Microfiber Fringed Dust Mop | 27.5" l x 9.0" w x 0.5" h | 3.5 lb | 69.9 cm x 22.9 cm x 1.3 cm | 1.6 kg | 6 |
| FGQ43800 | GR00 | 36" (91.4 cm) HYGEN™ Microfiber Fringed Dust Mop | 40.0" l x 9.0" w x 0.5" h | 5.0 lb | 101.6 cm x 22.9 cm x 1.3 cm | 2.3 kg | 6 |
| FGQ44900 | GR00 | 48" (121.9 cm) HYGEN™ Microfiber Fringed Dust Mop | 52.0" l x 9.0" w x 0.5" h | 6.8 lb | 132.1 cm x 22.9 cm x 1.3 cm | 3.1 kg | 6 |
| FGQ46000 | GR00 | 60" (152.4 cm) HYGEN™ Microfiber Fringed Dust Mop | 66.5" l x 9.0" w x 0.5" h | 8.5 lb | 168.9 cm x 22.9 cm x 1.3 cm | 3.9 kg | 6 |

* Always use cleaning chemicals or disinfectants as directed by your facility manager

** Based on internal testing without bleach

When ordering products with **BOLD** color codes, please specify color code after the product number. Refer to the Standard Color Guide at the back of the catalog.

UTILITY REFUSE AND RECYCLING

DECORATIVE REFUSE

CLEANING

MATERIAL HANDLING

WASHROOM

FOODSERVICE

ACCESSORIES & INDEX



Microfiber Damp Mops

Premium split-blended HYGEN™ damp mops deliver optimal mopping performance.

- Patented scrubber strips effectively remove dirt without streaking or smearing
- Colored edge tape allows for task-specific cleaning and reduces the risk of cross-transmission
- Industry leading hook and loop backing won't degrade during commercial launderings

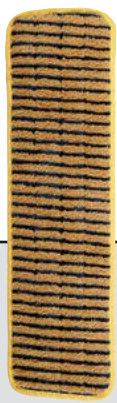

FGQ81000



FGQ41000



1863895

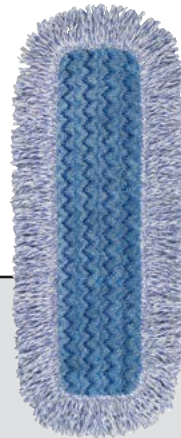

FGQ41600

PROVEN TO REMOVE
99.9%
OF MICROBES

BLEACH-
SAFE
in hot & cold water

Certified to tolerate CDC hot and cold water laundering requirements.*

DURABLE UP TO
500

laundings**
(up to 200 with bleach)

| NO. | COLOR | DESCRIPTION | U.S. DIMENSIONS | U.S. SHIP WT/CTN | METRIC DIMENSIONS | METRIC SHIP WT/CTN | PACK |
|----------|------------------|--|---------------------------|------------------|----------------------------|--------------------|------|
| FGQ82000 | BL00 | 11" (27.9 cm) HYGEN™ Microfiber Wall/Stair Damp Mop | 13.0" l x 5.2" w x 0.5" h | 1.5 lb | 33.0 cm x 13.2 cm x 1.3 cm | 0.7 kg | 6 |
| FGQ81000 | YL00 | 18" (45.7 cm) HYGEN™ Microfiber Super Scrubber Mop | 20.5" l x 5.2" w x 0.5" h | 2.0 lb | 52.1 cm x 13.2 cm x 1.3 cm | 0.9 kg | 6 |
| FGQ41000 | GR00, RD00, BL00 | 18" (45.7 cm) HYGEN™ Microfiber Damp Room Mop | 20.5" l x 5.2" w x 0.5" h | 2.9 lb | 52.1 cm x 13.2 cm x 1.3 cm | 1.3 kg | 12 |
| 1863895 | GRAY | Executive Series™ HYGEN™ 18" Microfiber Wet Pad | 20.5" l x 5.2" w x 0.5" h | 2.9 lb | 52.1 cm x 13.2 cm x 1.3 cm | 1.3 kg | 12 |
| FGQ41500 | BL00 | 18" (45.7 cm) HYGEN™ Microfiber Damp Mop with Scrubber | 20.5" l x 5.2" w x 0.5" h | 2.8 lb | 52.1 cm x 13.2 cm x 1.3 cm | 1.3 kg | 6 |
| FGQ41600 | BL00 | 18" (45.7 cm) HYGEN™ Microfiber High-Absorbency Mop | 20.5" l x 5.2" w x 0.5" h | 4.0 lb | 52.1 cm x 13.2 cm x 1.3 cm | 1.8 kg | 6 |
| FGQ41100 | BL00 | 24" (61 cm) HYGEN™ Microfiber Damp Room Mop | 26.0" l x 5.2" w x 0.5" h | 4.1 lb | 66.0 cm x 13.2 cm x 1.3 cm | 1.9 kg | 12 |
| FGQ42500 | BL00 | 24" (61 cm) HYGEN™ Microfiber Damp Mop with Scrubber | 26.8" l x 5.2" w x 0.5" h | 3.1 lb | 68.1 cm x 13.2 cm x 1.3 cm | 1.4 kg | 6 |
| 1822352 | WHITE | HYGEN™ Disposable 18" Microfiber Mop, Pkg. of 150 | 18.5" l x 5.2" w x 0.5" h | 6.0 lb | 47.0 cm x 13.2 cm x 1.3 cm | 2.7 kg | 1 |



UTILITY REFUSE AND RECYCLING

DECORATIVE REFUSE

CLEANING

MATERIAL HANDLING

WASHROOM

FOODSERVICE

ACCESSORIES & INDEX

HYGEN™ Quick-Connect Single-Sided Frames

Quick-Connect Frames feature a flat profile that slides easily under furniture and equipment. Trapezoidal shape improves cleaning in corners and other hard-to-reach areas.

- Lightweight aluminum construction is safe for MRI rooms
- Replaceable hook-and-loop strips attach all HYGEN™ Microfiber Damp and Dust Mops
- Rounded plastic end caps help protect walls and furniture



FGQ56000



EXECUTIVE
SERIES™
1863893

FGQ57000 24" QUICK-CONNECT FRAME WITH SQUEEGEE

Features a unique pull-type squeegee for water and debris collection.



FGQ57000



FGQ56000

| NO. | COLOR | DESCRIPTION | U.S. DIMENSIONS | U.S. SHIP WT/CTN | METRIC DIMENSIONS | METRIC SHIP WT/CTN | PACK |
|----------|--------------|--|-------------------------|------------------|----------------------------|--------------------|------|
| FGQ55000 | YL00 | 11" (27.9 cm) HYGEN™ Quick-Connect Wet/Dry Frame | 11" l x 3.0" w x 1.5" h | 4.9 lb | 27.9 cm x 7.6 cm x 3.8 cm | 2.2 kg | 6 |
| FGQ56000 | YL00 | 17" (43.2 cm) (45.7 cm) HYGEN™ Quick-Connect Wet/Dry Frame | 17" l x 3.0" w x 1.5" h | 6.5 lb | 43.2 cm x 7.6 cm x 3.8 cm | 2.9 kg | 6 |
| 1863893 | BLACK | Executive 17" (43.2 cm) HYGEN™ Quick-Connect Wet/Dry Frame | 17" l x 3.0" w x 1.5" h | 6.5 lb | 43.2 cm x 7.6 cm x 3.8 cm | 2.9 kg | 6 |
| FGQ57000 | YL00 | 24" (61 cm) HYGEN™ Quick-Connect Wet/Dry Frame With Squeegee | 24" l x 3.0" w x 1.5" h | 9.2 lb | 61.0 cm x 7.6 cm x 3.8 cm | 4.2 kg | 6 |
| FGQ58000 | YL00 | 35" (88.9 cm) HYGEN™ Quick-Connect Hall Dusting Frame | 35" l x 3.0" w x 1.5" h | 13.1 lb | 88.9 cm x 7.6 cm x 3.8 cm | 5.9 kg | 6 |
| FGQ59000 | YL00 | 47" (119.4 cm) HYGEN™ Quick-Connect Hall Dusting Frame | 47" l x 3.0" w x 1.5" h | 16.7 lb | 119.4 cm x 7.6 cm x 3.8 cm | 7.6 kg | 6 |
| FGQ59500 | YL00 | 59" (149.9 cm) HYGEN™ Quick-Connect Hall Dusting Frame | 59" l x 3.0" w x 1.5" h | 20.8 lb | 149.9 cm x 7.6 cm x 3.8 cm | 9.4 kg | 6 |

Quick-Connect Frame Accessories

| NO. | COLOR | DESCRIPTION | U.S. DIMENSIONS | U.S. SHIP WT/CTN | METRIC DIMENSIONS | METRIC SHIP WT/CTN | PACK |
|----------|-------------|--|-----------------------------------|------------------|-----------------------------------|--------------------|------|
| FGQ11000 | BK00 | 11" (27.9 cm) HYGEN™ Hook-and-Loop Replacement Set for FGQ55000 | 8.7", 10.0" l x 1.1" w x 0.25" h | 0.86 lb | 22.1, 25.4 cm x 2.8 cm x 0.6 cm | 0.39 kg | 6 |
| FGQ18000 | BK00 | 17" (43.2 cm) HYGEN™ Hook-and-Loop Replacement Set for FGQ56000 | 14.7", 16.0" l x 1.1" w x 0.25" h | 1.0 lb | 37.3, 40.6 cm x 2.8 cm x 0.6 cm | 0.04 kg | 6 |
| FGQ24000 | BK00 | 24" (61 cm) HYGEN™ Hook-and-Loop Replacement Set for FGQ57000 | 21.3", 22.6" l x 1.1" w x 0.25" h | 1.28 lb | 54.1, 57.4 cm x 2.8 cm x 0.6 cm | 0.58 kg | 6 |
| FGQ36000 | BK00 | 35" (88.9 cm) HYGEN™ Hook-and-Loop Replacement Set for FGQ58000 | 32.6", 33.9" l x 1.1" w x 0.25" h | 1.64 lb | 82.8, 86.1 cm x 2.8 cm x 0.6 cm | 0.74 kg | 6 |
| FGQ48000 | BK00 | 47" (119.4 cm) HYGEN™ Hook-and-Loop Replacement Set for FGQ59000 | 44.6", 45.9" l x 1.1" w x 0.25" h | 2.06 lb | 113.3, 116.6 cm x 2.8 cm x 0.6 cm | 0.93 kg | 6 |
| FGQ60000 | BK00 | 59" (149.9 cm) HYGEN™ Hook-and-Loop Replacement Set for FGQ59500 | 56.7", 58.0" l x 1.1" w x 0.25" h | 2.48 lb | 144.0, 147.3 cm x 2.8 cm x 0.6 cm | 1.1 kg | 6 |

HYGEN™ Quick-Connect Equipment

Quick-Connect handles and poles make cleaning more efficient in every area of the facility. The unique connection mechanism allows for easy, time-saving tool exchange.

- Lightweight aluminum construction is safe for MRI rooms
- Handles available in straight or ergonomic bend styles, in adjustable lengths between 20" and 72"
- Extension poles make quick work of high-reach cleaning tasks, with lengths up to 18'
- FGQ70100 Quick-Connect Adapter allows use of Quick-Connect handles and poles with any standard threaded tool



Quick-Connect Handles and Extension Poles

| NO. | COLOR | DESCRIPTION | U.S. DIMENSIONS | U.S. SHIP WT/CTN | METRIC DIMENSIONS | METRIC SHIP WT/CTN | PACK |
|----------|--------|---|---|------------------|--|--------------------|------|
| FGQ74500 | YL00 | 20"-40" (50.8 cm-101.6 cm) HYGEN™ Quick-Connect Short Extension Handle | Open: 40" l x 2" w x 2" h Closed: 20" l x 2" w x 2" h | 6.5 lb | Open: 101.6 cm x 5.1 cm x 5.1 cm Closed: 50.8 cm x 5.1 cm x 5.1 cm | 2.9 kg | 6 |
| 1863883 | SILVER | Executive 20" to 40" (50.8 cm-101.6 cm) HYGEN™ Microfiber Telescoping Handle | Open: 40" l x 2" w x 2" h Closed: 20" l x 2" w x 2" h | 6.5 lb | Open: 101.6 cm x 5.1 cm x 5.1 cm Closed: 50.8 cm x 5.1 cm x 5.1 cm | 2.9 kg | 6 |
| FGQ75000 | YL00 | 58" (147.3 cm) HYGEN™ Quick-Connect Handle | 58" l x 1.6" w x 1.6" h | 6.3 lb | 147.3 cm x 4.1 cm x 4.1 cm | 2.9 kg | 6 |
| FGQ75500 | YL00 | 48"-72" (121.9 cm-182.9 cm) HYGEN™ Quick-Connect Straight Extension Handle | Open: 72" l x 2" w x 2" h Closed: 41" l x 2" w x 2" h | 8.8 lb | Open: 182.9 cm x 5.1 cm x 5.1 cm Closed: 104.1 cm x 5.1 cm x 5.1 cm | 4 kg | 6 |
| 1863882 | SILVER | Executive 42" to 72" (121.9 cm-182.9 cm) HYGEN™ Microfiber Telescoping Handle | Open: 72" l x 2" w x 2" h Closed: 41" l x 2" w x 2" h | 8.8 lb | Open: 182.9 cm x 5.1 cm x 5.1 cm Closed: 104.1 cm x 5.1 cm x 5.1 cm | 4 kg | 6 |
| FGQ76000 | 0000 | 48"-72" (121.9 cm-182.9 cm) HYGEN™ Quick-Connect Ergo Adjustable Handle | Open: 72" l x 7.5" w x 2.5" h Closed: 48" l x 7.5" w x 2.5" h | 8.7 lb | Open: 182.9 cm x 19.1 cm x 6.4 cm Closed: 121.9 cm x 19.1 cm x 6.4 cm | 3.9 kg | 6 |
| FGQ76500 | YL00 | 4'-8' HYGEN™ Quick-Connect Extension Pole | Open: 96" l x 2.1" w x 2.1" h Closed: 48" l x 2.1" w x 2.1" h | 16.7 lb | Open: 243.8 cm x 5.3 cm x 5.3 cm Closed: 121.9 cm x 5.3 cm x 5.3 cm | 7.6 kg | 6 |
| FGQ77000 | YL00 | 6'-12' HYGEN™ Quick-Connect Extension Pole | Open: 144" l x 2.1" w x 2.1" h Closed: 72" l x 2.1" w x 2.1" h | 21.7 lb | Open: 365.8 cm x 5.3 cm x 5.3 cm Closed: 182.9 cm x 5.3 cm x 5.3 cm | 9.8 kg | 6 |
| FGQ77500 | YL00 | 6'-18' HYGEN™ Quick-Connect Extension Pole | Open: 216" l x 2.1" w x 2.1" h Closed: 72" l x 2.1" w x 2.1" h | 16.6 lb | Open: 548.6 cm x 5.3 cm x 5.3 cm Closed: 182.9 cm x 5.3 cm x 5.3 cm | 7.5 kg | 3 |
| FGQ70100 | BK00 | ACME to HYGEN™ Quick-Connect Adapter | 4.5" l x 1.1" w x 1.1" h | 0.3 lb | 11.4 cm x 2.8 cm x 2.8 cm | 0.14 kg | 3 |

UTILITY REFUSE AND RECYCLING

DECORATIVE REFUSE

CLEANING

MATERIAL HANDLING

WASHROOM

FOODSERVICE

ACCESSORIES & INDEX



HYGEN™ Microfiber Buckets

HYGEN™ Microfiber Buckets complete a highly efficient flat mop cleaning system.

Charging Bucket

- Use with HYGEN™ Microfiber Damp Mops and Quick-Connect tools for a continuous cleaning process with “no touch” wringing
- Easy-to-clean, lightweight nonporous plastic construction
- Buckets work with all HYGEN™ Microfiber Cleaning Carts

Charging Bucket with Sieve

- Sieve design enables users to effectively and ergonomically moisten mops
- Holds double-sided microfiber mops

Press Wring Bucket

- Use when flood cleaning or heavier liquid lay-down is desired
- Press sieve provides easy, “no touch” wringing
- For use with single-sided microfiber flat mops up to 18" in length
- Nonmarking casters
- Floor drain for fast emptying
- Available in blue with lid (item FGQ93000) for floor finish application



FGQ95088

EXECUTIVE SERIES™
1863892

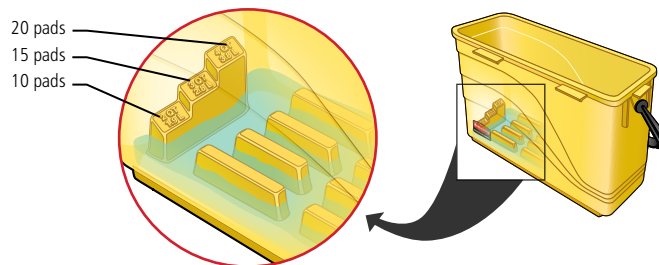

FGQ95088 Bucket design prevents oversaturation of microfiber mops and features a measuring guide for filling with cleaning and disinfecting solution before mops are added.

USING THE 1791802 CHARGING BUCKET

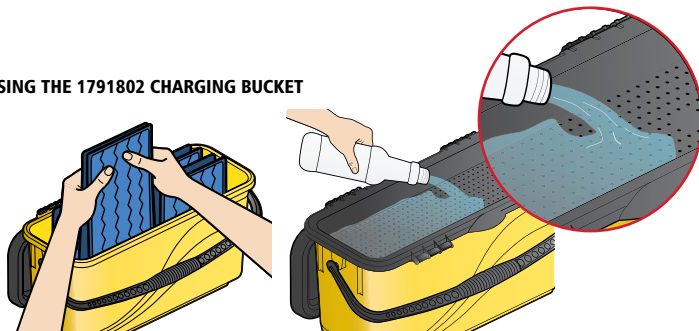

1. Fold the mop in half with the face material outside. Place folded mop vertically inside the bucket.
2. Pour disinfectant over the hinged sieve to moisten the mops evenly.



1791802



Unique, ribbed “washboard” surface removes dirt and debris from mops before wringing.



FGQ90088

| NO. | COLOR | DESCRIPTION | U.S. DIMENSIONS | U.S. SHIP WT/CTN | METRIC DIMENSIONS | METRIC SHIP WT/CTN | PACK |
|----------|---------------|--|------------------------------|------------------|-----------------------------|--------------------|------|
| FGQ95088 | YEL | HYGEN™ Charging Bucket | 23.88" l x 9.5" w x 13.63" h | 16 lb | 60.7 cm x 24.1 cm x 34.6 cm | 7.3 kg | 3 |
| 1863892 | GRAY | Executive HYGEN™ Microfiber Charging Mop Bucket | 23.88" l x 9.5" w x 13.63" h | 16 lb | 60.7 cm x 24.1 cm x 34.6 cm | 7.3 kg | 3 |
| 1791802 | YELLOW | HYGEN™ Charging Bucket with Sieve | 23.88" l x 9.5" w x 13.63" h | 17 lb | 60.7 cm x 24.1 cm x 34.6 cm | 7.9 kg | 3 |
| FGQ90088 | YEL | HYGEN™ Press Wring Bucket | 14.5" l x 26.2" w x 16.1" h | 10 lb | 36.8 cm x 66.5 cm x 40.9 cm | 4.6 kg | 1 |

UTILITY REFUSE AND RECYCLING

DECORATIVE REFUSE

CLEANING

MATERIAL HANDLING

WASHROOM

FOODSERVICE

ACCESSORIES & INDEX

PULSE™ Microfiber Floor Cleaning System with Single-Sided Frame

PULSE™ Mop cleans more square feet in less time when used with HYGEN™ Microfiber Damp Mops for cleaner floors faster and easier.

- Patented onboard reservoir and solution system evenly dispense liquid behind the mop



FGQ96600
PULSE™ Caddy

LIGHTWEIGHT CONSTRUCTION
WEIGHS 6 LBS FULLY LOADED

1835528

ERGONOMIC TRIGGER HANDLE

EXECUTIVE SERIES™
1863884

ONBOARD RESERVOIR HOLDS ENOUGH
SOLUTION TO CLEAN 850 SQ FT

FLUID LEVEL WINDOWS

PULSE™ MOPPING KIT INCLUDES:

- One Trigger Handle with Fluid Reservoir
- One 17" HYGEN™ Quick-Connect Frame (FGQ56000YL00)
- Two 18" HYGEN™ Damp Mops (FGQ41000BL00)

| NO. | COLOR | DESCRIPTION | U.S. DIMENSIONS | U.S. CAPACITY | U.S. SHIP WT/CTN | METRIC DIMENSIONS | METRIC CAPACITY | METRIC SHIP WT/CTN | PACK |
|----------|--------|---|-------------------------------|---------------|------------------|-----------------------------|-----------------|--------------------|------|
| 1835528 | YELLOW | HYGEN™ PULSE™ Mopping Kit with Single-Sided Frame | 56" l x 4.88" w x 3.75" h | 19 oz | 5.7 lb | 142.2 cm x 12.4 cm x 9.5 cm | .56 L | 2.6 kg | 1 |
| 1863884 | SILVER | Executive HYGEN™ PULSE™ Microfiber Spray Mop, Single-Sided Flat Mop | 56" l x 4.88" w x 3.75" h | 19 oz | 5.7 lb | 142.2 cm x 12.4 cm x 9.5 cm | .56 L | 2.6 kg | 1 |
| FGQ96600 | 0000 | HYGEN™ PULSE™ Caddy | 14.13" l x 8.75" w x 10.75" h | 2 gal | 3.6 lb | 35.9 cm x 22.2 cm x 27.3 cm | 7.5 L | 1.6 kg | 1 |



PULSE™ Microfiber Floor Cleaning System with Double-Sided Frame

The PULSE™ Double-Sided Mopping Kit combines dust and wet mopping with no downtime switching tools. Simply flip the mop over to transition from dry cleaning to wet mopping. The onboard reservoir eliminates the need for filling and emptying buckets.

Or, use with double-sided microfiber damp mops to double the number of square feet cleaned without replacing the mop.

1835529 PULSE™ Floor Cleaning Kit with Double-Sided Frame

Includes:
Trigger Handle with Fluid Reservoir,
one Double-Sided Folding Frame, and
two microfiber dust and wet mops.

ONBOARD FLUID RESERVOIR
High-capacity refillable reservoir holds enough solution to clean up to 850 sq ft of floor space. Reservoir windows allow easy monitoring of fluid level.

TRIGGER HANDLE

Red ergonomic trigger handle dispenses three streams of cleaning solution with each press.

LIGHTWEIGHT CONSTRUCTION

Weighs only 4 lbs when fully loaded with solution.

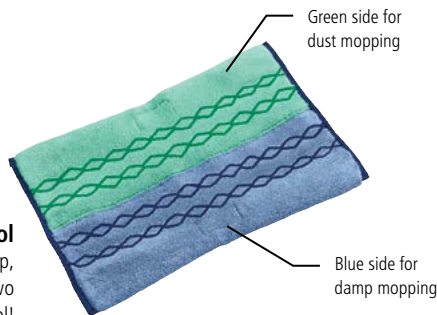

2 Jobs, 1 Tool
Simply dust mop, flip, and damp mop—accomplish two tasks with only one tool!



BLEACH-SAFE
in hot & cold water

Certified to tolerate CDC hot and cold water laundering requirements*

DURABLE UP TO 500
laundryings**
(up to 200 with bleach)



Double-Sided Microfiber Mops
Specifically designed for the HYGEN™ Clean Water System, HYGEN™ Charging Bucket with Sieve, and Double-Sided PULSE™ Mopping Kit, the double-sided mop design provides twice the coverage and consistent, streak-free cleaning.

- HYGEN™ double-sided mops feature different textiles on each side to target specific floor types
- Color-coded ribbons allow for task-specific cleaning and reduce cross-transmission



COLOR-CODED RIBBONS

Classify mop usage to help prevent cross-contamination.

| NO. | COLOR | DESCRIPTION | U.S. DIMENSIONS | U.S. SHIP WT/CTN | METRIC DIMENSIONS | METRIC SHIP WT/CTN | PACK |
|------------|------------|--|--------------------------|------------------|----------------------------|--------------------|------|
| 1791678 | GRAY | HYGEN™ General-Purpose Microfiber Mop | 17.5" l x 12" w x 0.5" h | 3.1 lb | 44.5 cm x 30.5 cm x 1.3 cm | 1.4 kg | 6 |
| 1791796 | BLUE | HYGEN™ Rough-Surface Scrub Microfiber Mop | 17.5" l x 12" w x 1" h | 3.5 lb | 44.5 cm x 30.5 cm x 2.5 cm | 1.6 kg | 6 |
| 1791680 | BLUE | HYGEN™ Microfiber Mop Plus | 17.5" l x 12" w x 0.5" h | 2.6 lb | 44.5 cm x 30.5 cm x 1.3 cm | 1.2 kg | 6 |
| 1791679*** | GREEN/BLUE | HYGEN™ Microfiber Wet and Dust Mop Plus for PULSE™ | 17.5" l x 12" w x 0.5" h | 2.7 lb | 44.5 cm x 30.5 cm x 1.3 cm | 1.2 kg | 6 |

* Always use cleaning chemicals or disinfectants as directed by your facility manager

** Based on internal testing without bleach

*** To be used with PULSE™ with Double-Sided Frame

UTILITY REFUSE AND RECYCLING

DECORATIVE REFUSE

CLEANING

MATERIAL HANDLING

WASHROOM

FOODSERVICE

ACCESSORIES & INDEX

Double-Sided Frames

- Easy to attach and detach mop
- Stainless steel components for enhanced durability
- For use with Double-Sided Microfiber Mops

EXECUTIVE SERIES™
1863894



Double-Sided Frame
Provides twice the coverage.

EASY HANDS-FREE MOP ATTACHMENT



1. Place frame on open mop and slide it into pockets.





2. Lift . . .



. . . and fold the frame closed for double-sided mopping.

| NO. | COLOR | DESCRIPTION | U.S. DIMENSIONS | U.S. CAPACITY | U.S. SHIP WT/ CTN | METRIC DIMENSIONS | METRIC CAPACITY | METRIC SHIP WT/ CTN | PACK |
|----------|--------|---|-------------------------------|---------------|-------------------|-----------------------------|-----------------|---------------------|------|
| 1835529 | YELLOW | HYGEN™ PULSE™ Mopping Kit with Double-Sided Folding Frame | 52" l x 4.25" w x 3.5" h | 19 oz | 4.5 lb | 132.1 cm x 10.8 cm x 8.9 cm | .56 L | 2.0 kg | 1 |
| 1863885 | SILVER | Executive HYGEN™ PULSE™ Microfiber Spray Mop, Double-Sided Flat Mop | 52" l x 4.25" w x 3.5" h | 19 oz | 4.5 lb | 132.1 cm x 10.8 cm x 8.9 cm | .56 L | 2.0 kg | 1 |
| 1863894* | BLACK | Executive 18" HYGEN™ PULSE™ Microfiber Flat Mop Frame, Double-Sided | 16.25" l x 8.5" w x 0.938" h | N/A | 6.25 lb | 41.3 cm x 21.6 cm x 2.4 cm | N/A | 2.8 kg | 3 |
| FGQ96600 | 0000 | HYGEN™ PULSE™ Caddy | 14.13" l x 8.75" w x 10.75" h | 2 gal | 3.6 lb | 35.9 cm x 22.2 cm x 27.3 cm | 7.5 L | 1.6 kg | 1 |

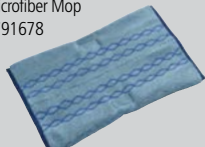
*To be used with PULSE™ with Double-Sided Frame.

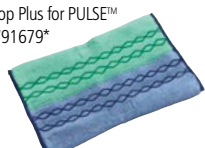
| | Microbe Removal | Absorbency | Grease/Oil Removal | General Soil Removal | Durability | Floor Type | Environment |
|--|-----------------|------------|--------------------|----------------------|------------|---|--|
| General-Purpose Microfiber Mop 1791678  | | | | | | Smooth surfaces such as VCT, Linoleum, and Marble | Office Buildings, Schools, Retail Stores, Airports, and Stadiums |
| Rough-Surface Scrub Microfiber Mop 1791796  | | | | | | Textured surfaces such as Ceramic Tile, Natural Stone, and Terrazzo | Restaurants, Schools |
| Microfiber Mop Plus 1791680  | 99.9% | | | | | Smooth surfaces such as VCT, Linoleum, and Marble | Healthcare |
| Microfiber Wet and Dust Mop Plus for PULSE™ 1791679*  | 99.9% | | | | | Smooth surfaces such as VCT, Linoleum, and Marble | Healthcare |

HYGEN™ Microfiber Flexible Dusting Wands

Removes dust from crevices and hard-to-reach places.

- Wand bends to conform to irregular surfaces
- Use with HYGEN™ Quick-Connect handles to convert wand into an extended-reach cleaning tool



BLEACH-
SAFE

in hot & cold water

Certified to tolerate CDC hot and cold water laundering requirements*

FGQ85200



BETTER SURFACE CONTACT

Flexible duster frame conforms to the shape of the surface being cleaned. Excellent for cleaning hard-to-reach areas. Use hand-held or with HYGEN™ Quick-Connect handles and extension poles.

| NO. | COLOR | DESCRIPTION | U.S. DIMENSIONS | U.S. SHIP WT/CTN | METRIC DIMENSIONS | METRIC SHIP WT/CTN | PACK |
|----------|-------------|---|-----------------------------|------------------|----------------------------|--------------------|------|
| FGQ85000 | BK00 | HYGEN™ Quick-Connect Flexible Dusting Wand with Microfiber Sleeve | 28.75" l x 3.25" w x 1.5" h | 1.8 lb | 73 cm x 8.3 cm x 3.8 cm | 0.8 kg | 6 |
| FGQ85100 | GR00 | HYGEN™ Wand Duster Microfiber Replacement Sleeve | 22.7" l x 3.25" w x 0.75" h | 1.2 lb | 57.7 cm x 8.3 cm x 1.9 cm | 0.5 kg | 6 |
| FGQ85200 | WH00 | Executive 22" HYGEN™ Multipurpose Flexible Microfiber Duster and Frame | 28.4" l x 1.13" w x 1.13" h | 5.0 lb | 72.1 cm x 2.9 cm x 2.9 cm | 2.3 kg | 6 |
| FGQ85300 | WH00 | Executive 22" HYGEN™ Multipurpose Flexible Microfiber Duster | 12.3" l x 7" w x 0.74" h | 2.8 lb | 31.2 cm x 17.8 cm x 1.9 cm | 1.3 kg | 6 |

* Always use cleaning chemicals or disinfectants as directed by your facility manager

HYGEN™ Microfiber Mitts

HYGEN™ mitts are double-sided to easily dust and damp clean crevices and irregular surfaces.

- Ideal for cleaning glass and chrome surfaces, general-purpose cleaning, and dry dusting
- Use in pairs for added efficiency



| NO. | COLOR | DESCRIPTION | U.S. DIMENSIONS | U.S. SHIP WT/CTN | METRIC DIMENSIONS | METRIC SHIP WT/CTN | PACK |
|----------|-------------|--|------------------|------------------|-------------------|--------------------|------|
| FGQ65000 | GR00 | HYGEN™ Microfiber All-Purpose Mitt with Thumb | 11" l x 8.75" w | 2.4 lb | 27.9 cm x 22.2 cm | 1.1 kg | 12 |
| FGQ65100 | BL00 | HYGEN™ Microfiber Glass/Mirror Mitt with Thumb | 11" l x 8.75" w | 2.2 lb | 27.9 cm x 22.2 cm | 1 kg | 12 |
| FGQ65200 | GR00 | HYGEN™ Microfiber Dusting Mitt with Thumb | 11.9" l x 9.9" w | 1.5 lb | 30.2 cm x 25.1 cm | 0.7 kg | 6 |

UTILITY REFUSE AND RECYCLING

DECORATIVE REFUSE

CLEANING

MATERIAL HANDLING

WASHROOM

FOODSERVICE

ACCESSORIES & INDEX

HYGEN™ Sanitizer-Safe Microfiber Cloths

The more durable and versatile solution for back-and front-of-house cleaning tasks.

- Proven to remove 95% of microbes
- Quat- and bleach-safe to help maintain sanitizer effectiveness
- Cleans effectively with less chemical replenishment
- Removes stains 30% more effectively than cotton cloths
- Launderable up to 40x

1824723



| NO. | COLOR | DESCRIPTION | U.S. DIMENSIONS | U.S. SHIP WT/CTN | METRIC DIMENSIONS | METRIC SHIP WT/CTN | PACK |
|---------|-------------|--|----------------------------|------------------|-------------------------------|--------------------|------|
| 1805727 | RD00 | Sanitizer-Safe Microfiber Cloth – Red | 19" l x 16" w x 0.06" h | 23.04 lb | 48.26 cm x 40.64 cm x 0.15 cm | 10.45 kg | 288 |
| 1805728 | BL00 | Sanitizer-Safe Microfiber Cloth – Blue | 19" l x 16" w x 0.06" h | 23.04 lb | 48.26 cm x 40.64 cm x 0.15 cm | 10.45 kg | 288 |
| 1805730 | GR00 | Sanitizer-Safe Microfiber Cloth – Green | 19" l x 16" w x 0.06" h | 23.04 lb | 48.26 cm x 40.64 cm x 0.15 cm | 10.45 kg | 288 |
| 1824723 | RD/BL/YL/GR | Sanitizer-Safe Microfiber Cloth – 4-Pack | 7.25" l x 1.75" w x 8.0" h | 4.00 lb | 18.42 cm x 4.45 cm x 20.32 cm | 1.82 kg | 4 |

HYGEN™ Microfiber Kit with Charging Bucket

The single-source solution with all microfiber products needed to clean up to 12 patient rooms.

- 7.25-cubic-foot storage capacity offers 40% more space than traditional carts so user spends less time retrieving supplies and more time completing the task at hand
- Secure cabinet doors keep cleaning supplies concealed from view and locked up when carts are unattended
- Quiet nonmarking 8" wheels and 4" casters provide smooth maneuverability
- Compact size fits great in space-constrained areas; with a high capacity-to-footprint ratio, only 22" wide
- Joint commission-compliant to meet Environment of Care Standard 3.10.3 with locking doors and hood



| NO. | COLOR | DESCRIPTION | U.S. DIMENSIONS | U.S. SHIP WT/CTN | METRIC DIMENSIONS | METRIC SHIP WT/CTN | PACK |
|---------|-------|--|-----------------------|------------------|------------------------------|--------------------|------|
| 1784284 | N/A | HYGEN™ Microfiber Kit with Charging Bucket | 48" l x 29" w x 27" h | 112.0 lb | 121.9 cm x 73.7 cm x 68.6 cm | 50.9 kg | 1 |

UTILITY REFUSE AND RECYCLING

DECORATIVE REFUSE

CLEANING

MATERIAL HANDLING

WASHROOM

FOODSERVICE

ACCESSORIES & INDEX

Light Commercial Microfiber Cloths and Mops

Quality microfiber products for less-demanding users.

- Hook-and-loop backing attaches pads securely to frame
- Durable up to 200 commercial launderings and 100 with bleach
- Proven to remove 99.9% of microbes



| NO. | COLOR | DESCRIPTION | U.S. DIMENSIONS | U.S. SHIP WT/CTN | METRIC DIMENSIONS | METRIC SHIP WT/CTN | PACK |
|----------|-------------|--|-----------------------------|------------------|-----------------------------|--------------------|------|
| FGQ40800 | GR00 | 18" (45.7 cm) Light Commercial Microfiber Fringed Dust Mop | 20" l x 8" w x 0.5" h | 3.0 lb | 50.8 cm x 20.3 cm x 1.3 cm | 1.3 kg | 12 |
| FGQ40900 | BL00 | 18" (45.7 cm) Light Commercial Microfiber Damp Mop | 20" l x 5" w x 0.5" h | 1.8 lb | 50.8 cm x 12.7 cm x 1.3 cm | 0.8 kg | 12 |
| FGQ55900 | BK00 | 18" (45.7 cm) Light Commercial Quick-Connect Wet/Dry Plastic Frame | 17.6" l x 3.0" w x 1.5" h | 6.1 lb | 44.7 cm x 7.6 cm x 3.8 cm | 2.8 kg | 6 |
| 1820577 | PINK | 12" x 12" Microfiber Light Commercial Cloth | 12" l x 12" w | 13.8 lb | 30.5 cm x 30.5 cm | 6.3 kg | 288 |
| 1820578 | GREEN | 12" x 12" Microfiber Light Commercial Cloth | 12" l x 12" w | 13.8 lb | 30.5 cm x 30.5 cm | 6.3 kg | 288 |
| 1820579 | BLUE | 12" x 12" Microfiber Light Commercial Cloth | 12" l x 12" w | 13.8 lb | 30.5 cm x 30.5 cm | 6.3 kg | 288 |
| 1820580 | YELLOW | 12" x 12" Microfiber Light Commercial Cloth | 12" l x 12" w | 13.8 lb | 30.5 cm x 30.5 cm | 6.3 kg | 288 |
| 1863888 | GRAY | Executive 12" Multipurpose Microfiber Cloth | 12" l x 12" w | 13.8 lb | 30.5 cm x 30.5 cm | 6.3 kg | 288 |
| 1820581 | PINK | 16" x 16" Microfiber Light Commercial Cloth | 16" l x 16" w | 13.8 lb | 40.6 cm x 40.6 cm | 6.3 kg | 288 |
| 1820582 | GREEN | 16" x 16" Microfiber Light Commercial Cloth | 16" l x 16" w | 13.8 lb | 40.6 cm x 40.6 cm | 6.3 kg | 288 |
| 1820583 | BLUE | 16" x 16" Microfiber Light Commercial Cloth | 16" l x 16" w | 13.8 lb | 40.6 cm x 40.6 cm | 6.3 kg | 288 |
| 1820584 | YELLOW | 16" x 16" Microfiber Light Commercial Cloth | 16" l x 16" w | 13.8 lb | 40.6 cm x 40.6 cm | 6.3 kg | 288 |
| 1863889 | GRAY | Executive 16" Multipurpose Microfiber Towel | 16" l x 16" w | 13.8 lb | 40.6 cm x 40.6 cm | 6.3 kg | 288 |
| FGQ74900 | YL00 | 52" (132 cm) Light Commercial Quick-Connect Steel Handle | 52" l 1.0" w 1.0" h | 7.1 lb | 132.1 cm x 2.5 cm x 2.5 cm | 3.2 kg | 6 |
| 3486108 | N/A | Light Commercial Microfiber Spray Mop (mop pad not included) | 52" l x 4.5" w x 3.5" h | 3.0 lb | 132.1 cm x 11.4 cm x 8.9 cm | 1.4 kg | 1 |
| 3486110 | N/A | 15-oz Replacement Refill Cartridge for 3486108 | 3.25" l x 2.75" w x 8.75" h | 2.4 lb | 8.3 cm x 7.0 cm x 22.2 cm | 1.1 kg | 6 |

When ordering products with **BOLD** color codes, please specify color code after the product number. Refer to the Standard Color Guide at the back of the catalog.

FLOW™ Finishing Systems

Help reduce labor costs and improve worker productivity and well-being with the highly portable FLOW™ Floor Finishing System. High-capacity backpack and handle system allows user-controlled release of solution for more efficient floor finishing.

FGQ97900 FLOW™ FLAT MOP FINISH KIT

INCLUDES:

Backpack, Trigger Handle, 17" Quick-Connect Frame, and FGQ80500 FLOW™ Nylon Flat Mop



CLEAN CONNECT™ TECHNOLOGY:
Backpack hose connects to the trigger handle using Clean Connect™ technology for spill-free delivery of finish solution.

TRIGGER HANDLE
Red ergonomic trigger handle dispenses finish solution with each press.

IMPROVED COMFORT
Backpack features venting channels to improve airflow and reduce moisture on back while wearing.

PROTECTS WORKER WELL-BEING
Chest and waist straps distribute weight onto user's hips instead of shoulders, reducing user strain.

STRING MOP OR FLAT MOP OPTIONS
Kit includes an FGQ80500 FLOW™ Nylon Flat Mop. It connects easily to the handle using Quick-Connect.



High-Capacity Backpack System

FLOW™ holds 1.5 gallons for finishing up to 3,000 sq ft of floor surface. The 3" diameter opening makes refilling easy.

| NO. | COLOR | DESCRIPTION | U.S. DIMENSIONS | U.S. CAPACITY | U.S. SHIP WT/ CTN | METRIC DIMENSIONS | METRIC CAPACITY | METRIC SHIP WT/ CTN | PACK |
|----------|-------|---------------------------|----------------------------|---------------|-------------------|-----------------------------|-----------------|---------------------|------|
| FGQ97900 | YL00 | FLOW™ Flat Mop Finish Kit | 56" l x 9.75" w x 3.75" h | 1.5 gal | 8.2 lb | 142.2 cm x 24.8 cm x 9.5 cm | 5.7 L | 3.7 kg | 1 |
| FGQ80500 | WH00 | FLOW™ Nylon Flat Mop | 6.5" l x 3.15" w x 19.7" h | N/A | 5 lb | 16.5 cm x 8 cm x 50 cm | N/A | 2.3 kg | 6 |
| FGQ97700 | 0000 | FLOW™ Replacement Bladder | 20" l x 6" w x 0.4" h | 1.5 gal | 2.4 lb | 50.8 cm x 15.2 cm x 1 cm | 5.7 L | 1.1 kg | 2 |

UTILITY REFUSE AND RECYCLING

DECORATIVE REFUSE

CLEANING

MATERIAL HANDLING

WASHROOM

FOODSERVICE

ACCESSORIES & INDEX

Microfiber Flat Mop Finishing

Finish Bucket

Same features as the Microfiber Press Wring Bucket, in the blue color most often associated with finish applications.

Finish Pad

Produce beautiful, professional results easier and more quickly than traditional methods.

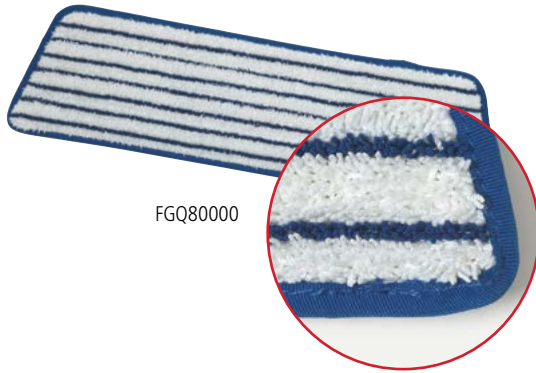

FGQ80000



FGQ93000

Microfiber Finish System

Helps ensure controlled absorption and release of finish.

- Delivers 200–300 square feet (18.6 m²–27.9 m²) of coverage with a single mop load of finish
- Split microfiber for the fastest and smoothest finish application
- Resealable Finish Bucket (FGQ93000) keeps finish fresh until the next job, saving cleanup time
- Smooth, nonporous bucket cleans easily, reducing time spent on stripping traditional mop bucket/wringer combinations



FGQ05000

Microfiber Flat Mop Pad

| NO. | COLOR | DESCRIPTION | U.S. DIMENSIONS | U.S. SHIP WT/CTN | METRIC DIMENSIONS | METRIC SHIP WT/CTN | PACK |
|----------|-------------|-------------------------------------|-----------------------------|------------------|-----------------------------|--------------------|------|
| FGQ80000 | WH00 | 18" (45.7 cm) Microfiber Finish Pad | 18" l x 5.5" w x 0.5" h | 1.9 lb | 45.7 cm x 14 cm x 1.3 cm | 0.9 kg | 6 |
| FGQ93000 | BLUE | Finish Bucket | 14.7" l x 26.2" w x 16.2" h | 12.1 lb | 37.3 cm x 66.5 cm x 41.1 cm | 5.5 kg | 1 |

Microfiber Finish System

| NO. | COLOR | DESCRIPTION | U.S. DIMENSIONS | U.S. CAPACITY | U.S. SHIP WT/CTN | METRIC DIMENSIONS | METRIC CAPACITY | METRIC SHIP WT/CTN | PACK |
|----------|-------------|--|-----------------|---------------|------------------|-------------------|-----------------|--------------------|------|
| FGQ05000 | 0000 | Microfiber Finish System, Includes Bucket with Lid, Sieve, 8 Pads, 1 Frame | 18" l x 5" w | 22 qt | 10.6 lb | 45.7 cm x 12.7 cm | 20.8 L | 4.8 kg | 1 |
| FGE05200 | WH00 | Finish Mop, Looped Fringe | 18" l x 5" w | N/A | 5.0 lb | 45.7 cm x 12.7 cm | N/A | 2.3 kg | 6 |

UTILITY REFUSE AND RECYCLING

DECORATIVE REFUSE

CLEANING

MATERIAL HANDLING

WASHROOM

FOODSERVICE

ACCESSORIES & INDEX



UTILITY REFUSE
AND RECYCLING

DECORATIVE REFUSE

CLEANING

MATERIAL HANDLING

WASHROOM

FOODSERVICE

ACCESSORIES
& INDEX

1835528, FGQ41600BL00, 1861427

www.rubbermaidcommercial.com





WAVEBRAKE®

JUST GOT A

WHOLE LOT BETTER

Rubbermaid Commercial Products introduced the first resin mop bucket in 1974. The BRUTE® mop bucket was introduced in 1995 with new ergonomic features. WaveBrake® was introduced in 2005 with a patented bucket and baffle design that reduced splashing for more efficient, safer mopping.

Rubbermaid Commercial Products continues to innovate, improving the industry-leading splash reduction and adding new features that surpass any other traditional mop bucket. These new features help the New Generation WaveBrake® clean floors with less effort to get the job done safer.

Proudly made in Winchester, Virginia, WaveBrake® features structural web-molded plastic construction to ensure the highest quality and durability you have come to expect while delivering industry-leading performance.

THE NEW GENERATION WAVEBRAKE®



UTILITY REFUSE
AND RECYCLING

DECORATIVE REFUSE

CLEANING

MATERIAL HANDLING

WASHROOM

FOODSERVICE

ACCESSORIES
& INDEX



UP TO 80% LESS SPLASH¹

Patented WaveBrake® baffles result in less splashing while mopping and maneuvering, helping to create a safer environment for patrons and staff.



EASY TO EMPTY

A built-in drain eliminates the strain of lifting and bending when emptying mop buckets. Integrated handles help ensure a secure grip to lift and empty the mop bucket.



5-YEAR WRINGER GUARANTEE²

The side-press and down-press wringers are designed to last 5 years or 200,000 wringing cycles.

¹ Versus competitive 35Qt U.S. single compartment mop bucket and wringer, not including divider bucket and accessories. ² Based on internal side-press testing.



COLOR-CODED

CLEANING

Cleaning professionals today use a color-coded cleaning system, using color-coded buckets, handles and mops to help reduce cross-contamination. Additionally, they can be organized by function, department or building area, making it easier to track usage.

RECOMMENDED USAGE:

Color-coding systems can vary by vertical and application; however, Rubbermaid Commercial Products, in alignment with industry experts, recommends the following system:

- **Yellow:** Back-of-House Cleaning
- **Brown:** Back-of-House Cleaning
- **Red:** High-Risk Restroom Areas
- **Blue:** General-Purpose Cleaning
- **Green:** General Food Processing, Serving and Bar Areas
- **Black:** Front-of-House Cleaning



WaveBrake® Buckets and Wringers
 With features that surpass traditional mop buckets, the new generation of WaveBrake® helps to clean floors with less effort to get the job done safer, without sacrificing quality and durability.

- **IMPROVE SAFETY AND PRODUCTIVITY:** Patented WaveBrake® baffles result in less splashing while mopping and maneuvering, helping to create a safer environment for patrons and staff. Additionally, water stays in the bucket, eliminating unnecessary trips to the storage closet to fill up the bucket, enhancing productivity.
- **80% LESS SPLASHING:** Molded-in WaveBrake® baffles disrupt wave formation, reducing splash up to 80% versus leading competitors.* (*Versus competitive U.S. 35 qt single compartment mop bucket and wringer, not including divider bucket and accessories.)
- **CONVENIENT TO EMPTY:** The new generation of the WaveBrake® mop bucket is designed to safely empty water with less effort. Integrated handles, sink ledge, and a pour spout provide control while lifting and emptying, for a safe and stable emptying process.
- **DESIGNED TO LAST:** The new generation WaveBrake® wringer is designed and built to the highest of quality standards. WaveBrake® wringers have an industry-leading warranty of 5-years.
- **INTEGRATED HANDLES AND SINK LEDGE:** Lift and empty the mop bucket easily, with less strain.
- **POUR SPOUT:** Helps prevent water from spilling onto floors while emptying dirty water, to help floor remain dry and safe.

COLORS AVAILABLE: 



WaveBrake® Side-Press Bucket and Wringer

| NO. | COLOR | DESCRIPTION | U.S. DIMENSIONS | U.S. SHIP WT | U.S. CAPACITY | METRIC DIMENSIONS | METRIC SHIP WT | METRIC CAPACITY | PACK |
|--------------|--------|---|--------------------------------|--------------|---------------|--------------------------------|----------------|-----------------|------|
| FG748000YEL | Yellow | 26 qt WaveBrake® Side-Press Bucket and Wringer | 18.88" l x 16.63" w x 23.5" h | 20.67 lb | 26 qt | 47.94 cm x 42.23 cm x 59.69 cm | 9.38 kg | 24.61 L | 1 |
| FG758088YEL | Yellow | 35 qt WaveBrake® Side-Press Bucket and Wringer | 20.31" l x 16.44" w x 21.63" h | 21.55 lb | 35 qt | 51.59 cm x 41.75 cm x 54.93 cm | 9.78 kg | 33.12 L | 1 |
| FG758088BRN | Brown | 35 qt WaveBrake® Side-Press Bucket and Wringer | 20.31" l x 16.44" w x 21.63" h | 21.55 lb | 35 qt | 51.59 cm x 41.75 cm x 54.93 cm | 9.78 kg | 33.12 L | 1 |
| FG758888BLUE | Blue | 35 qt WaveBrake® Side-Press Bucket and Wringer | 20.31" l x 16.44" w x 21.63" h | 21.55 lb | 35 qt | 51.59 cm x 41.75 cm x 54.93 cm | 9.78 kg | 33.12 L | 1 |
| FG758888RED | Red | 35 qt WaveBrake® Side-Press Bucket and Wringer | 20.31" l x 16.44" w x 21.63" h | 21.55 lb | 35 qt | 51.59 cm x 41.75 cm x 54.93 cm | 9.78 kg | 33.12 L | 1 |
| FG758888GRN | Green | 35 qt WaveBrake® Side-Press Bucket and Wringer | 20.31" l x 16.44" w x 21.63" h | 21.55 lb | 35 qt | 51.59 cm x 41.75 cm x 54.93 cm | 9.78 kg | 33.12 L | 1 |
| 1863896 | Black | 35 qt WaveBrake® Side-Press Bucket and Wringer, Executive Series™ | 30.19" l x 16.56" w x 20.50" h | 24.37 lb | 35 qt | 76.68 cm x 42.07 cm x 52.07 cm | 11.05 kg | 33.12 L | 1 |
| 2031764 | Yellow | 35 qt WaveBrake® Side-Press Bucket and Wringer with Drain | 20.31" l x 16.44" w x 21.63" h | 21.55 lb | 35 qt | 51.59 cm x 41.75 cm x 54.93 cm | 9.78 kg | 33.12 L | 1 |
| FG618688YEL | Yellow | 44 qt WaveBrake® Side-Press Bucket and Wringer with Drain | 23.63" l x 16.81" w x 19.75" h | 21.60 lb | 44 qt | 60.00 cm x 42.70 cm x 50.17 cm | 9.80 kg | 41.64 L | 1 |

WaveBrake® Down-Press Bucket and Wringer

| NO. | COLOR | DESCRIPTION | U.S. DIMENSIONS | U.S. SHIP WT | U.S. CAPACITY | METRIC DIMENSIONS | METRIC SHIP WT | METRIC CAPACITY | PACK |
|--------------|--------|---|--------------------------------|--------------|---------------|--------------------------------|----------------|-----------------|------|
| FG757788YEL | Yellow | 35 qt WaveBrake® Down-Press Bucket and Wringer | 20.31" l x 16.44" w x 21.63" h | 21.55 lb | 35 qt | 51.59 cm x 41.75 cm x 54.93 cm | 9.78 kg | 33.12 L | 1 |
| FG757788BRN | Brown | 35 qt WaveBrake® Down-Press Bucket and Wringer | 20.31" l x 16.44" w x 21.63" h | 21.55 lb | 35 qt | 51.59 cm x 41.75 cm x 54.93 cm | 9.78 kg | 33.12 L | 1 |
| FG757888BLUE | Blue | 35 qt WaveBrake® Down-Press Bucket and Wringer | 20.31" l x 16.44" w x 21.63" h | 21.55 lb | 35 qt | 51.59 cm x 41.75 cm x 54.93 cm | 9.78 kg | 33.12 L | 1 |
| FG757888RED | Red | 35 qt WaveBrake® Down-Press Bucket and Wringer | 20.31" l x 16.44" w x 21.63" h | 21.55 lb | 35 qt | 51.59 cm x 41.75 cm x 54.93 cm | 9.78 kg | 33.12 L | 1 |
| FG757888GRN | Green | 35 qt WaveBrake® Down-Press Bucket and Wringer | 20.31" l x 16.44" w x 21.63" h | 21.55 lb | 35 qt | 51.59 cm x 41.75 cm x 54.93 cm | 9.78 kg | 33.12 L | 1 |
| 1863898 | Black | 35 qt WaveBrake® Down-Press Bucket and Wringer, Executive Series™ | 30.19" l x 16.56" w x 27.75" h | 22.30 lb | 35 qt | 76.68 cm x 42.07 cm x 70.49 cm | 10.12 kg | 33.12 L | 1 |
| FG757688YEL | Yellow | 44 qt WaveBrake® Down-Press Bucket and Wringer with Drain | 28.81" l x 17.00" w x 23.50" h | 27.25 lb | 44 qt | 60.48 cm x 43.18 cm x 59.69 cm | 12.36 kg | 41.64 L | 1 |

UTILITY REFUSE AND RECYCLING

DECORATIVE REFUSE

CLEANING

MATERIAL HANDLING

WASHROOM

FOODSERVICE

ACCESSORIES & INDEX



WaveBrake® Institutional Bucket and Wringer

With features that surpass traditional mop buckets, the new generation of WaveBrake® helps to clean floors with less effort to get the job done safer, without sacrificing quality and durability.

- **IMPROVE SAFETY AND PRODUCTIVITY:** Patented WaveBrake® baffles result in less splashing while mopping and maneuvering, helping to create a safer environment for patrons and staff. Additionally, water stays in the bucket, eliminating unnecessary trips to the storage closet to fill up the bucket, enhancing productivity.
- **80% LESS SPLASHING:** Molded-in WaveBrake® baffles disrupt wave formation, reducing splash up to 80% versus leading competitors.* (*Versus competitive U.S. 35 qt single compartment mop bucket and wringer, not including divider bucket and accessories.)
- **CONVENIENT TO EMPTY:** The new generation of the WaveBrake® mop bucket is designed to safely empty water with less effort. Integrated handles, sink ledge, and a pour spout provide control while lifting and emptying, for a safe and stable emptying process.
- **INTEGRATED HANDLES AND SINK LEDGE:** Lift and empty the mop bucket easily, with less strain.
- **POUR SPOUT:** Helps prevent water from spilling onto floors while emptying dirty water, to help floor remain dry and safe.



| NO. | COLOR | DESCRIPTION | U.S. DIMENSIONS | U.S. SHIP WT | U.S. CAPACITY | METRIC DIMENSIONS | METRIC SHIP WT | METRIC CAPACITY | PACK |
|-------------|---------------|---|--------------------------------|--------------|---------------|--------------------------------|----------------|-----------------|------|
| FG759088YEL | Yellow | 35 qt WaveBrake® Institutional Bucket and Sieve Wringer | 20.13" l x 16.75" w x 20.50" h | 13.95 lb | 35 qt | 51.12 cm x 42.55 cm x 52.07 cm | 6.33 kg | 33.12 L | 1 |

WaveBrake® Bucket and Casters

With features that surpass traditional mop buckets, the new generation of WaveBrake® helps to clean floors with less effort to get the job done safer, without sacrificing quality and durability.

- **IMPROVE SAFETY AND PRODUCTIVITY:** Patented WaveBrake® baffles result in less splashing while mopping and maneuvering, helping to create a safer environment for patrons and staff. Additionally, water stays in the bucket, eliminating unnecessary trips to the storage closet to fill up the bucket, enhancing productivity.
- **80% LESS SPLASHING:** Molded-in WaveBrake® baffles disrupt wave formation, reducing splash up to 80% versus leading competitors.* (*Versus competitive U.S. 35 qt single compartment mop bucket and wringer, not including divider bucket and accessories.)
- **CONVENIENT TO EMPTY:** The new generation of the WaveBrake® mop bucket is designed to safely empty water with less effort. Integrated handles, sink ledge, and a pour spout provide control while lifting and emptying, for a safe and stable emptying process.
- **INTEGRATED HANDLES AND SINK LEDGE:** Lift and empty the mop bucket easily, with less strain.
- **POUR SPOUT:** Helps prevent water from spilling onto floors while emptying dirty water, to help floor remain dry and safe.
- **SECURE WRINGER CONNECTIONS:** Integrated wringer-guides ensure a secure connection to mop bucket, providing stability while wringing and maneuvering, to help prevent spills.



2064914



2031763

| NO. | COLOR | DESCRIPTION | U.S. DIMENSIONS | U.S. SHIP WT | U.S. CAPACITY | METRIC DIMENSIONS | METRIC SHIP WT | METRIC CAPACITY | PACK |
|---------|---------------|--|--------------------------------|--------------|---------------|--------------------------------|----------------|-----------------|------|
| 2064996 | Yellow | 26 qt WaveBrake® Bucket and Casters | 19.25" l x 16.01" w x 15.17" h | 38.07 lb | 26 qt | 48.90 cm x 40.77 cm x 38.54 cm | 17.27 kg | 24.61 L | 4 |
| 2064914 | Yellow | 35 qt WaveBrake® Bucket and Casters | 20.25" l x 16.05" w x 17.29" h | 42.99 lb | 35 qt | 51.44 cm x 40.77 cm x 43.92 cm | 19.50 kg | 33.12 L | 4 |
| 2031763 | Yellow | 35 qt WaveBrake® Bucket and Casters with Drain | 20.13" l x 16.75" w x 18.25" h | 12.02 lb | 35 qt | 51.12 cm x 42.55 cm x 46.36 cm | 5.45 kg | 33.12 L | 1 |

UTILITY REFUSE AND RECYCLING

DECORATIVE REFUSE

CLEANING

MATERIAL HANDLING

WASHROOM

FOODSERVICE

ACCESSORIES & INDEX

Tandem™ 31-Qt Bucket and Wringer Combo

All-in-one compact design for effective wringing and no more lost parts.

- One-piece design: integrated bucket and wringer
- Holes in both wringing plates force more water from mop in less time
- 2½" casters for excellent maneuverability
- Built-in lift handles on bottom of bucket make lifting and emptying easier
- Accepts up to 24-oz mops



| NO. | COLOR | DESCRIPTION | U.S. DIMENSIONS | U.S. SHIP WT/CTN | U.S. CAPACITY | METRIC DIMENSIONS | METRIC SHIP WT | METRIC CAPACITY | PACK |
|----------|-------|--|--------------------------------|------------------|---------------|-----------------------------|----------------|-----------------|------|
| FG738000 | YEL | Tandem™ 31-Qt Bucket and Wringer Combo | 22.63" l x 13.25" w x 32.25" h | 11.8 lb | 31 qt | 57.5 cm x 33.7 cm x 81.9 cm | 5.4 kg | 29 L | 1 |

WaveBrake® Wringers

The new generation WaveBrake® wringer is designed and built to the highest of quality standards. WaveBrake® wringers have an industry-leading warranty of 5-years.

- 5-YEAR WRINGER GUARANTEE: The side-press and down-press wringers are designed to last 5-years or 200,000 cycles.
- SECURE WRINGER CONNECTIONS: Integrated wringer-guides ensure a secure connection to mop bucket, providing stability while wringing and maneuvering, to help prevent spills.
- WRINGS A VARIETY OF MOP SIZES: Wringer effectively wrings a variety of mop sizes, ranging from XS – XL (10oz – 32oz).
- DURABLE WRINGER HANDLE: Handle is made from steel, with a comfort grip for long-lasting durability

COLORS AVAILABLE:



2064915



2064959

WaveBrake® Dirty Water Buckets

Keeping the dirty water separate from clean water, the dirty water bucket helps to reduce the potential for cross-contamination. Executive Series™ WaveBrake® models include the dirty water bucket as standard.

COLORS AVAILABLE:



2064907

| NO. | COLOR | DESCRIPTION | U.S. DIMENSIONS | U.S. SHIP WT | U.S. CAPACITY | METRIC DIMENSIONS | METRIC SHIP WT | METRIC CAPACITY | PACK |
|---------|--------|--|--------------------------------|--------------|---------------|---------------------------------|----------------|-----------------|------|
| 2064915 | Yellow | WaveBrake® Side-Press Wringer | 15.75" l x 13.38" w x 31.13" h | 22.30 lb | N/A | 40.01 cm x 33.97 cm x 79.06 cm | 10.12 kg | N/A | 2 |
| 2064885 | Brown | WaveBrake® Side-Press Wringer | 15.75" l x 13.38" w x 31.13" h | 22.30 lb | N/A | 40.01 cm x 33.97 cm x 79.06 cm | 10.12 kg | N/A | 2 |
| 2064888 | Blue | WaveBrake® Side-Press Wringer | 15.75" l x 13.38" w x 31.13" h | 22.30 lb | N/A | 40.01 cm x 33.97 cm x 79.06 cm | 10.12 kg | N/A | 2 |
| 2064884 | Red | WaveBrake® Side-Press Wringer | 15.75" l x 13.38" w x 31.13" h | 22.30 lb | N/A | 40.01 cm x 33.97 cm x 79.06 cm | 10.12 kg | N/A | 2 |
| 2064912 | Green | WaveBrake® Side-Press Wringer | 15.75" l x 13.38" w x 31.13" h | 22.30 lb | N/A | 40.01 cm x 33.97 cm x 79.06 cm | 10.12 kg | N/A | 2 |
| 2064960 | Black | WaveBrake® Side-Press Wringer, Executive Series™ | 15.75" l x 13.38" w x 31.13" h | 22.30 lb | N/A | 40.01 cm x 33.97 cm x 79.06 cm | 10.12 kg | N/A | 2 |
| 2064959 | Yellow | WaveBrake® Down-Press Wringer | 12.81" l x 11.94" w x 39.88" h | 21.27 lb | N/A | 32.54 cm x 30.32 cm x 101.28 cm | 9.65 kg | N/A | 2 |
| 2065003 | Brown | WaveBrake® Down-Press Wringer | 12.81" l x 11.94" w x 39.88" h | 21.27 lb | N/A | 32.54 cm x 30.32 cm x 101.28 cm | 9.65 kg | N/A | 2 |
| 2064999 | Blue | WaveBrake® Down-Press Wringer | 12.81" l x 11.94" w x 39.88" h | 21.27 lb | N/A | 32.54 cm x 30.32 cm x 101.28 cm | 9.65 kg | N/A | 2 |
| 2065001 | Red | WaveBrake® Down-Press Wringer | 12.81" l x 11.94" w x 39.88" h | 21.27 lb | N/A | 32.54 cm x 30.32 cm x 101.28 cm | 9.65 kg | N/A | 2 |
| 2064953 | Green | WaveBrake® Down-Press Wringer | 12.81" l x 11.94" w x 39.88" h | 21.27 lb | N/A | 32.54 cm x 30.32 cm x 101.28 cm | 9.65 kg | N/A | 2 |
| 2064994 | Black | WaveBrake® Down-Press Wringer, Executive Series™ | 12.81" l x 11.94" w x 39.88" h | 21.27 lb | N/A | 32.54 cm x 30.32 cm x 101.28 cm | 9.65 kg | N/A | 2 |
| 2064907 | Red | 35 qt WaveBrake® Dirty Water Bucket | 15.19" l x 9.75" w x 14.00" h | 14.95 lb | 35 qt | 38.58 cm x 24.77 cm x 35.56 cm | 6.78 kg | 33.12 L | 6 |
| 2064905 | Gray | 35 qt WaveBrake® Dirty Water Bucket | 15.19" l x 9.75" w x 14.00" h | 14.95 lb | 37 qt | 38.58 cm x 24.77 cm x 35.56 cm | 6.78 kg | 33.12 L | 6 |



MOP CONSTRUCTION DEFINED

YARN TYPE

Mop yarn type is the most impactful driver of mop launderability, absorbency, durability, and release. Understanding mop yarn type helps drive proper mop selection for varying applications.

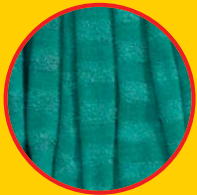

MICROFIBER TUBE

Most durable, stands up to abrasive cleaning and heavy-duty scrubbing with excellent absorbency.



FINISH

Designed to provide smooth and even release of chemical and floor finish. Less linting compared to rayon.



MICROFIBER

Highly durable, non-abrasive general-purpose mop.



RAYON

General-purpose mopping. Reliable liquid absorption. Highest quality of yarn. Resists mildew growth, extending mop life and white appearance.



BLEND SHRINKLESS®

General-purpose mopping. Pre-laundered for reduced shrinking. Longer-lasting and less linting compared to cotton. Highly absorbent/no break-in required.



SYNTHETIC BLEND

All-synthetic mop yarns resist abrasive floor surfaces.



BLEND

General-purpose mopping. Longer-lasting and less linting compared to cotton. Highly absorbent/no break-in required.



CLEAN ROOM

Made of woven rayon/polyester fabric that will not fray or lint. For use in Class 10,000 and higher industrial applications.



COTTON

General-purpose mopping. Least expensive yarn option. Reliable liquid absorption. Requires break-in, dries slowly, may lint.



ROUGH-FLOOR

Knitted fleece cotton/polyester blend yarn for highly abrasive surfaces. High absorbency.



NON-WOVEN

General-purpose mopping. Least expensive wet mop option. Highly absorbent. Requires no break-in and delivers reduced linting versus cotton. Not launderable.



NYLON

Non-linting, continuous filament yarn for finishing applications. High launderability.

When ordering products with **BOLD** color codes, please specify color code after the product number. Refer to the Standard Color Guide at the back of the catalog.

HEADBAND TYPE

Headbands drive mop handle selection and can be made of cloth or mesh. Mesh headbands dry faster and can sometimes be used as a scrubbing tool due to the abrasive nature of the material.



1" HEADBAND

Most optimal with side-gate Invader® Wet Mop Handle.



5" HEADBAND

Most optimal with clamp-style Gripper® Wet Mop Handle.



UNIVERSAL HEADBAND

Compatible with Gripper® and Invader® Wet Mop Handles.



BOLT-ON HEADBAND

Works with Bolt-on Wet Mop Handle.

TAILBAND TYPE

Tailbands prevent tangling and improve floor coverage for more efficient mopping. Not all mops have tailbands.



WOVEN TAILBAND

Allows for commercial laundering. Most expensive type of tailband.



YARN TAILBAND

Requires handwashing or limited residential laundering. Economical tailband choice.



NO TAILBAND

Requires handwashing only.

END TYPE

Mop ends can be looped or cut, and ultimately impact mop launderability, fraying, linting, and unraveling.



LOOPED END

Reduces fraying, linting, and unraveling. Allows for laundering, extending lifetime. Generally more expensive.



CUT END

Economical and practical general-purpose mop. Ends may fray and unravel. Does not incorporate tailband, covering less area. Disposable or hand wash.

REFERENCE GUIDE

Use the following guide to choose the best Rubbermaid Commercial Products Wet Mops for your facility.

| | | REFERENCE | | FLOOR TYPE/APPLICATION | | |
|----------------------------------|---------------|---|--------|--|---|--------------------------------------|
| | | | PAGE # | VINYL TILE, LAMINATE, SMOOTH CERAMIC TILE | ANTI-SLIP TILE, TERRAZZO, PAVER & QUARRY STONE | RUBBER, HARDWOOD, SMOOTH CONCRETE |
| GENERAL | BEST | WEB FOOT® MICROFIBER TUBE WET MOP | 103 | • | • | • |
| | | WEB FOOT® MICROFIBER STRING WET MOP | 103 | • | • | • |
| | | WEB FOOT® BLEND SHRINKLESS® WET MOP | 104 | • | • | • |
| | | WEB FOOT® BLEND SCRUBBING WET MOP | 104 | • | • | • |
| | | WEB FOOT® BLEND WET MOP | 104 | • | • | • |
| | | MAXIMIZER™ MICROFIBER BLEND WET MOP | 102 | • | • | • |
| | BETTER | MAXIMIZER™ BLEND WET MOP | 102 | • | • | • |
| | | SWINGER LOOP® WET MOP | 105 | • | • | • |
| | | SWINGER LOOP® SHRINKLESS® WET MOP | 105 | • | • | • |
| | | SUPER STITCH® BLEND SCRUBBING WET MOP | 108 | • | • | • |
| | | SUPER STITCH® BLEND WET MOP | 109 | • | • | • |
| | | SUPER STITCH® COTTON SCRUBBING WET MOP | 107 | • | • | • |
| | | SUPER STITCH® COTTON WET MOP | 108 | • | • | • |
| | | UNIVERSAL HEADBAND BLEND WET MOP | 109 | • | • | • |
| | GOOD | UNIVERSAL HEADBAND COTTON WET MOP | 110 | • | • | • |
| | | DISPOSABLE WET MOP | 111 | • | • | • |
| | | DURA PRO CUT-END BLEND WET MOP | 110 | • | • | • |
| | | BOLT-ON CUT-END BLEND WET MOP | 112 | • | • | • |
| DURA PRO CUT-END COTTON WET MOP | | 111 | • | • | • | |
| VALUE PRO CUT-END COTTON WET MOP | | 112 | • | • | • | |
| SPECIALTY | BEST | WEB FOOT® FINISH WET MOP | 105 | • | • | • |
| | | NYLON FINISH WET MOP | 114 | • | • | • |
| | | CLEAN ROOM MAINTENANCE WET MOP | 114 | • | • | • |
| | | ROUGH-FLOOR WET MOP | 114 | • | • | • |
| | | DISPOSABLE WET MOP | 111 | • | • | • |
| | BETTER | SWINGER LOOP® BLEND FINISH WET MOP | 107 | • | • | • |
| | | SUPER STITCH® BLEND FINISH WET MOP | 108 | • | • | • |
| | | SUPER STITCH® RAYON FINISH WET MOP | 107 | • | • | • |
| | | SYNTHETIC BLEND HOT WET MOP | 113 | • | • | • |
| | | UNIVERSAL HEADBAND RAYON FINISH WET MOP | 109 | • | • | • |
| | GOOD | DURA PRO RAYON FINISH WET MOP | 110 | • | • | • |
| | | BOLT-ON RAYON FINISH WET MOP | 112 | • | • | • |
| | | VALUE PRO RAYON FINISH WET MOP | 112 | • | • | • |

When ordering products with **BOLD** color codes, please specify color code after the product number. Refer to the Standard Color Guide at the back of the catalog.

| MOP CONSTRUCTION | | | | MOPPING ATTRIBUTES | |
|------------------|---------------|------------|---------------|--------------------------------------|-----------------------------|
| END TYPE | TAILBAND TYPE | YARN TYPE | HEADBAND SIZE | LAUNDERABILITY | SUSTAINABILITY |
| LOOPEd | WOVEN | MICROFIBER | 1", 5" | UP TO 200 COMMERCIAL LAUNDERINGS | UP TO 50% RECYCLED CONTENT |
| LOOPEd | WOVEN | MICROFIBER | 1", 5" | UP TO 100 COMMERCIAL LAUNDERINGS | UP TO 49% RECYCLED CONTENT |
| LOOPEd | WOVEN | BLEND | 1", 5" | UP TO 75 COMMERCIAL LAUNDERINGS | UP TO 80% RECYCLED CONTENT |
| LOOPEd | WOVEN | BLEND | UNIVERSAL | UP TO 75 COMMERCIAL LAUNDERINGS | UP TO 80% RECYCLED CONTENT |
| LOOPEd | WOVEN | BLEND | 1", 5" | UP TO 75 COMMERCIAL LAUNDERINGS | UP TO 80% RECYCLED CONTENT |
| LOOPEd | WOVEN | BLEND | UNIVERSAL | UP TO 100 COMMERCIAL LAUNDERINGS | UP TO 43% RECYCLED CONTENT |
| LOOPEd | WOVEN | BLEND | UNIVERSAL | UP TO 50 COMMERCIAL LAUNDERINGS | UP TO 75% RECYCLED CONTENT |
| LOOPEd | WOVEN | BLEND | 1", 5" | UP TO 50 COMMERCIAL LAUNDERINGS | UP TO 100% RECYCLED CONTENT |
| LOOPEd | WOVEN | BLEND | 1", 5" | UP TO 50 COMMERCIAL LAUNDERINGS | UP TO 100% RECYCLED CONTENT |
| LOOPEd | YARN | BLEND | UNIVERSAL | UP TO 50 RESIDENTIAL LAUNDERINGS | UP TO 100% RECYCLED CONTENT |
| LOOPEd | YARN | BLEND | 1", 5" | UP TO 50 RESIDENTIAL LAUNDERINGS | UP TO 100% RECYCLED CONTENT |
| LOOPEd | YARN | COTTON | UNIVERSAL | UP TO 50 RESIDENTIAL LAUNDERINGS | UP TO 100% RECYCLED CONTENT |
| LOOPEd | YARN | COTTON | 1" | UP TO 50 RESIDENTIAL LAUNDERINGS | UP TO 100% RECYCLED CONTENT |
| LOOPEd | YARN | BLEND | UNIVERSAL | UP TO 50 RESIDENTIAL LAUNDERINGS | UP TO 100% RECYCLED CONTENT |
| LOOPEd | YARN | COTTON | UNIVERSAL | UP TO 50 RESIDENTIAL LAUNDERINGS | UP TO 100% RECYCLED CONTENT |
| CUT | NON-WOVEN | DISPOSABLE | 1", 5" | 0 LAUNDERINGS; SINGLE USE DISPOSABLE | UP TO 99% RECYCLED CONTENT |
| CUT | NONE | BLEND | 1", 5" | HAND WASH ONLY | UP TO 100% RECYCLED CONTENT |
| CUT | NONE | BLEND | BOLT-ON | HAND WASH ONLY | UP TO 100% RECYCLED CONTENT |
| CUT | NONE | COTTON | 1", 5" | HAND WASH ONLY | UP TO 100% RECYCLED CONTENT |
| CUT | NONE | COTTON | 1", 5" | HAND WASH ONLY | UP TO 100% RECYCLED CONTENT |

| | | | | | |
|--------|----------|------------|-----------|--------------------------------------|----------------------------|
| LOOPEd | TAPELESS | BLEND | 1" | UP TO 75 COMMERCIAL LAUNDERINGS | UP TO 74% RECYCLED CONTENT |
| LOOPEd | YARN | NYLON | 1" | UP TO 75 COMMERCIAL LAUNDERINGS | NO RECYCLED CONTENT |
| LOOPEd | WOVEN | BLEND | 5" | UP TO 75 COMMERCIAL LAUNDERINGS | NO RECYCLED CONTENT |
| LOOPEd | WOVEN | BLEND | 5" | UP TO 75 COMMERCIAL LAUNDERINGS | NO RECYCLED CONTENT |
| N/A | N/A | DISPOSABLE | ONE SIZE | 0 LAUNDERINGS; SINGLE USE DISPOSABLE | UP TO 99% RECYCLED CONTENT |
| LOOPEd | TAPELESS | BLEND | 1" | UP TO 50 COMMERCIAL LAUNDERINGS | UP TO 74% RECYCLED CONTENT |
| LOOPEd | YARN | BLEND | 1", 5" | UP TO 50 RESIDENTIAL LAUNDERINGS | UP TO 74% RECYCLED CONTENT |
| LOOPEd | YARN | RAYON | 1", 5" | UP TO 50 RESIDENTIAL LAUNDERINGS | UP TO 75% RECYCLED CONTENT |
| CUT | NONE | BLEND | 1", 5" | HAND WASH ONLY | UP TO 70% RECYCLED CONTENT |
| LOOPEd | NONE | RAYON | UNIVERSAL | UP TO 50 RESIDENTIAL LAUNDERINGS | UP TO 75% RECYCLED CONTENT |
| CUT | NONE | RAYON | 1", 5" | HAND WASH ONLY | UP TO 75% RECYCLED CONTENT |
| CUT | NONE | RAYON | BOLT-ON | HAND WASH ONLY | UP TO 75% RECYCLED CONTENT |
| CUT | NONE | RAYON | 1" | HAND WASH ONLY | UP TO 75% RECYCLED CONTENT |



Maximizer™ Microfiber Blend Mops

The Maximizer™ Microfiber Mop provides best cost of ownership and highest level of cleaning power.

- The specially designed tailband delivers 30% greater spread in use
- 25% less weight means less effort when mopping and lifting
- The unique Maximizer™ Blend delivers the highest absorbency ratio of any mop in its class
- Absorbs up to 3X as much as cotton
- Industry-leading durability – Developed to withstand up to 100 commercial laundering cycles
- The universal headband is compatible with any traditional wet mop connection system and durable enough to withstand scrubbing applications



1924814

| NO. | COLOR | DESCRIPTION | U.S. HEADBAND SIZE | U.S. SHIP WT/CTN | MOP SIZE | METRIC HEADBAND SIZE | METRIC SHIP WT/CTN | HEADBAND COLOR | PACK |
|---------|-------|---------------------------|--------------------|------------------|----------|----------------------|--------------------|----------------|------|
| 1924813 | BLUE | Maximizer™ Microfiber Mop | Universal | 6.01 lb | Medium | Universal | 2.73 kg | Black | 6 |
| 1924812 | BLUE | Maximizer™ Microfiber Mop | Universal | 6.93 lb | Large | Universal | 3.14 kg | Black | 6 |
| 1924815 | GREEN | Maximizer™ Microfiber Mop | Universal | 6.01 lb | Medium | Universal | 2.73 kg | Black | 6 |
| 1924814 | GREEN | Maximizer™ Microfiber Mop | Universal | 6.93 lb | Large | Universal | 3.14 kg | Black | 6 |
| 1924817 | RED | Maximizer™ Microfiber Mop | Universal | 6.01 lb | Medium | Universal | 2.73 kg | Black | 6 |
| 1924816 | RED | Maximizer™ Microfiber Mop | Universal | 6.93 lb | Large | Universal | 3.14 kg | Black | 6 |

Maximizer™ Blend Mops

The unique Maximizer™ Blend delivers the highest absorbency ratio of any mop in its class

- The specially designed tailband delivers 30% greater spread in use
- 25% less weight means less effort when mopping and lifting
- The unique Maximizer™ Blend delivers the highest absorbency ratio of any mop in its class
- Absorbs up to 3X as much as cotton
- Industry-leading durability – Developed to withstand up to 50 commercial laundering cycles
- The universal headband is compatible with any traditional wet mop connection system and durable enough to withstand scrubbing applications



1924783

| NO. | COLOR | DESCRIPTION | U.S. HEADBAND SIZE | U.S. SHIP WT/CTN | MOP SIZE | METRIC HEADBAND SIZE | METRIC SHIP WT/CTN | HEADBAND COLOR | PACK |
|---------|-------|----------------------|--------------------|------------------|----------|----------------------|--------------------|----------------|------|
| 1924783 | BLUE | Maximizer™ Blend Mop | Universal | 6.01 lb | Medium | Universal | 2.73 kg | Black | 6 |
| 1924782 | BLUE | Maximizer™ Blend Mop | Universal | 6.93 lb | Large | Universal | 3.14 kg | Black | 6 |
| 1924787 | RED | Maximizer™ Blend Mop | Universal | 6.01 lb | Medium | Universal | 2.73 kg | Black | 6 |
| 1924786 | RED | Maximizer™ Blend Mop | Universal | 6.93 lb | Large | Universal | 3.14 kg | Black | 6 |

UTILITY REFUSE AND RECYCLING

DECORATIVE REFUSE

CLEANING

MATERIAL HANDLING

WASHROOM

FOODSERVICE

ACCESSORIES & INDEX

Web Foot® Mops

Web Foot® offers the best performance in the industry with maximum absorbency, ultimate durability, fast drying, and superior launderability.

- Contains antimicrobial product protection to inhibit the growth of bacteria that causes odors and stains and shortens useful product life
- Looped ends and tailbands reduce tangling for like-new performance after every laundering
- Prelaunched and preshrunk for longer product life
- Colorfast colors will not fade with repeated launderings
- Suitable for healthcare and general commercial maintenance applications
- Premium launderability, up to 75 launderings

BUILT-IN ANTIMICROBIAL PROTECTION

Rubbermaid Commercial Web Foot® mops incorporate antimicrobials directly into the yarn. Mops contain a built-in antimicrobial protection protecting the mop from bacteria, mold, and mildew growth, leaving floors dirt-free and lengthening the mop's useful life.

Web Foot® Microfiber Tube Mops

Designed to have greater floor contact and improved absorbency.

- Constructed with a blend of continuous-filament microfiber and polyester
- Superior absorbency and release characteristics
- Tube design reduces drag for increased productivity
- Recycled content: up to 50% PET Plastic
- Premium launderability, up to 200 launderings

BLEACH-SAFE
in hot & cold water



FOR MICROFIBER FLAT MOPS, SEE MICROFIBER MOPS.



FGT81206

| NO. | COLOR | DESCRIPTION | U.S. HEADBAND SIZE | U.S. SHIP WT/CTN | MOP SIZE | METRIC HEADBAND SIZE | METRIC SHIP WT/CTN | PACK |
|----------|-------|-------------------------------|--------------------|------------------|----------|----------------------|--------------------|------|
| FGT81206 | GR00 | Web Foot® Microfiber Tube Mop | 1" | 4.5 lb | Medium | 2.5 cm | 2 kg | 6 |
| FGT81306 | GR00 | Web Foot® Microfiber Tube Mop | 1" | 4.8 lb | Large | 2.5 cm | 2.2 kg | 6 |
| FGT85206 | GR00 | Web Foot® Microfiber Tube Mop | 5" | 4.5 lb | Medium | 12.7 cm | 2 kg | 6 |
| FGT85306 | GR00 | Web Foot® Microfiber Tube Mop | 5" | 4.8 lb | Large | 12.7 cm | 2.2 kg | 6 |

Web Foot® Microfiber String Mops

- Highly durable and absorbent for extra-long life
- Constructed with a blend of continuous-filament microfiber and antimicrobial yarn
- Premium launderability, up to 100 launderings

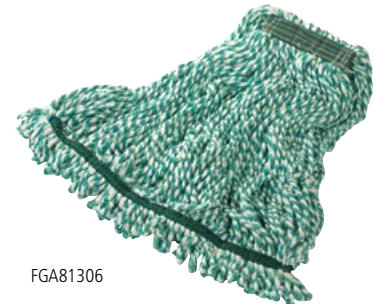

FGA81306

| NO. | COLOR | DESCRIPTION | U.S. HEADBAND SIZE | U.S. SHIP WT/CTN | MOP SIZE | METRIC HEADBAND SIZE | METRIC SHIP WT/CTN | HEADBAND COLOR | PACK |
|----------|-------|---------------------------------|--------------------|------------------|----------|----------------------|--------------------|----------------|------|
| FGA81206 | GR00 | Web Foot® Microfiber String Mop | 1" | 4.85 lb | | 2.54 cm | 2.2 kg | Green | 6 |
| FGA85206 | GR00 | Web Foot® Microfiber String Mop | 5" | 5.95 lb | | 12.7 cm | 2.7 kg | Green | 6 |
| FGA85306 | GR00 | Web Foot® Microfiber String Mop | 5" | 5.62 lb | | 12.7 cm | 2.6 kg | Green | 6 |
| FGA81306 | GR00 | Web Foot® Microfiber String Mop | 1" | 5.62 lb | | 2.54 cm | 2.6 kg | Green | 6 |

UTILITY REFUSE AND RECYCLING

DECORATIVE REFUSE

CLEANING

MATERIAL HANDLING

WASHROOM

FOODSERVICE

ACCESSORIES & INDEX

Web Foot® Blend Shrinkless® Mops

- Balanced 4-ply blend of cotton and synthetic yarn is prelaundered
- Woven tailband provides more floor coverage
- PVC-coated mesh headband prohibits moisture penetration and resists chemicals
- Recycled content: colors are up to 35% post-industrial cotton and 45% PET plastic; white is up to 35% post-industrial cotton
- Looped ends reduce fraying, linting, and unraveling
- Premium launderability, up to 75 launderings



FGA25206

| NO. | COLOR | DESCRIPTION | U.S. HEADBAND SIZE | U.S. SHIP WT/CTN | MOP SIZE | METRIC HEADBAND SIZE | METRIC SHIP WT/CTN | HEADBAND COLOR | PACK |
|----------|-------------------------------|-------------------------------|--------------------|------------------|----------|----------------------|--------------------|----------------|------|
| FGA21106 | GR00, WH00, BL00 | Web Foot® Shrinkless® Wet Mop | 1" | 5.8 lb | Small | 2.5 cm | 2.6 kg | YEL | 6 |
| FGA21206 | GR00, WH00, BL00 | Web Foot® Shrinkless® Wet Mop | 1" | 7.6 lb | Medium | 2.5 cm | 3.4 kg | GRN | 6 |
| FGA21306 | GR00, WH00, BL00 | Web Foot® Shrinkless® Wet Mop | 1" | 10.8 lb | Large | 2.5 cm | 4.9 kg | RED | 6 |
| FGA25106 | GR00, WH00, BL00, OR00 | Web Foot® Shrinkless® Wet Mop | 5" | 5.9 lb | Small | 12.7 cm | 2.7 kg | YEL | 6 |
| FGA25206 | GR00, WH00, BL00, OR00 | Web Foot® Shrinkless® Wet Mop | 5" | 7.7 lb | Medium | 12.7 cm | 3.5 kg | GRN | 6 |
| FGA25306 | GR00, WH00, BL00, OR00 | Web Foot® Shrinkless® Wet Mop | 5" | 11.0 lb | Large | 12.7 cm | 5 kg | RED | 6 |

Web Foot® Blend Scrubbing Wet Mops

The Scrubbing Wet Mop features an integrated scrubbing headband that removes stuck-on messes faster without interrupting the mopping process.

- Integrated scrubbing headband removes stuck-on debris 2x faster than a traditional Rubbermaid Commercial Products wet mop.
- Universal scrubbing headband is compatible with side-loading Invader® and clamp-style Gripper® handles.
- Double-sided and securely sewn-in scrubbing headband lasts the lifetime of the mop.
- Designed for effective scrubbing without scratching on a variety of floor types, including laminate, linoleum, vinyl, and light and dark hardwood.



2036140

| NO. | COLOR | DESCRIPTION | U.S. HEADBAND SIZE | U.S. SHIP WT/CTN | MOP SIZE | METRIC HEADBAND SIZE | METRIC SHIP WT/CTN | HEADBAND COLOR | PACK |
|---------|---------------|-----------------------------------|--------------------|------------------|----------|----------------------|--------------------|----------------|------|
| 2036140 | Green | Web Foot® Blend Scrubbing Wet Mop | Universal | 8.07 lb | Large | Universal | 3.66 kg | Green | 6 |
| 2036132 | White | Web Foot® Blend Scrubbing Wet Mop | Universal | 8.07 lb | Large | Universal | 3.66 kg | Green | 6 |
| 2036134 | Blue | Web Foot® Blend Scrubbing Wet Mop | Universal | 8.07 lb | Large | Universal | 3.66 kg | Green | 6 |
| 2036139 | Orange | Web Foot® Blend Scrubbing Wet Mop | Universal | 8.07 lb | Large | Universal | 3.66 kg | Green | 6 |
| 2036141 | Green | Web Foot® Blend Scrubbing Wet Mop | Universal | 6.75 lb | Medium | Universal | 3.06 kg | Green | 6 |
| 2036133 | White | Web Foot® Blend Scrubbing Wet Mop | Universal | 6.75 lb | Medium | Universal | 3.06 kg | Green | 6 |
| 2036135 | Blue | Web Foot® Blend Scrubbing Wet Mop | Universal | 6.75 lb | Medium | Universal | 3.06 kg | Green | 6 |
| 2036137 | Orange | Web Foot® Blend Scrubbing Wet Mop | Universal | 6.75 lb | Medium | Universal | 3.06 kg | Green | 6 |

Web Foot® Blend Mops

- Balanced blend of cotton and synthetic fibers delivers up to five times the absorbency of cotton mops
- Looped ends reduce fraying, linting, and unraveling
- Woven tailband provides more floor coverage
- Recycled content: colors are up to 35% post-industrial cotton and 45% PET plastic; white is up to 35% post-industrial cotton
- **Shipped as compact mop packages**
- Premium launderability, up to 75 launderings



FGA15206

| NO. | COLOR | DESCRIPTION | U.S. HEADBAND SIZE | U.S. SHIP WT/CTN | MOP SIZE | METRIC HEADBAND SIZE | METRIC SHIP WT/CTN | HEADBAND COLOR | PACK |
|----------|-------------------------------|-------------------|--------------------|------------------|----------|----------------------|--------------------|----------------|------|
| FGA11106 | WH00, BL00 | Web Foot® Wet Mop | 1" | 4.5 lb | Small | 2.5 cm | 2 kg | YEL | 6 |
| FGA11206 | GR00, WH00, BL00, OR00 | Web Foot® Wet Mop | 1" | 6.0 lb | Medium | 2.5 cm | 2.7 kg | GRN | 6 |
| FGA11306 | GR00, WH00, BL00, OR00 | Web Foot® Wet Mop | 1" | 8.6 lb | Large | 2.5 cm | 3.9 kg | RED | 6 |
| FGA15106 | GR00, WH00, BL00 | Web Foot® Wet Mop | 5" | 4.5 lb | Small | 12.7 cm | 2 kg | YEL | 6 |
| FGA15206 | GR00, WH00, BL00, OR00 | Web Foot® Wet Mop | 5" | 6.0 lb | Medium | 12.7 cm | 2.7 kg | GRN | 6 |
| FGA15306 | GR00, WH00, BL00, OR00 | Web Foot® Wet Mop | 5" | 8.6 lb | Large | 12.7 cm | 3.9 kg | RED | 6 |

UTILITY REFUSE AND RECYCLING

DECORATIVE REFUSE

CLEANING

MATERIAL HANDLING

WASHROOM

FOODSERVICE

ACCESSORIES & INDEX

Web Foot® Finish Mops

- Looped-end 4-ply synthetic yarn is designed for a controlled release of floor finish
- Tailband is sewn on the inside of mop and helps reduce the "drag" patterns common to most finish mops
- Recycled content: up to 74% PET plastic
- **Shipped as compact mop packages**
- Premium launderability, up to 75 launderings



FGA41206

| NO. | COLOR | DESCRIPTION | U.S. HEADBAND SIZE | U.S. SHIP WT/CTN | MOP SIZE | METRIC HEADBAND SIZE | METRIC SHIP WT/CTN | HEADBAND COLOR | PACK |
|----------|-------|----------------------|--------------------|------------------|----------|----------------------|--------------------|----------------|------|
| FGA41206 | WH00 | Web Foot® Finish Mop | 1" | 6.0 lb | Medium | 2.5 cm | 2.7 kg | WHT | 6 |
| FGA41306 | WH00 | Web Foot® Finish Mop | 1" | 8.6 lb | Large | 2.5 cm | 3.9 kg | WHT | 6 |

Swinger Loop® Shrinkless® Wet Mops

Prelaundered and preshrunk for increased mop performance after laundering.

- Balanced 4-ply blend of cotton and synthetic yarn for absorbency and strength
- Looped-end, woven tailbanded mop provides greater floor coverage
- PVC-coated mesh headband for longer product life
- Recycled content: colors are up to 65% post-industrial cotton and 35% PET plastic
- Standard launderability, up to 50 launderings



FGC25306

| NO. | COLOR | DESCRIPTION | U.S. HEADBAND SIZE | U.S. SHIP WT/CTN | MOP SIZE | METRIC HEADBAND SIZE | METRIC SHIP WT/CTN | HEADBAND COLOR | PACK |
|----------|------------------------|-----------------------------------|--------------------|------------------|----------|----------------------|--------------------|----------------|------|
| FGC21206 | GR00, BL00 | Swinger Loop® Shrinkless® Wet Mop | 1" | 7.6 lb | Medium | 2.5 cm | 3.4 kg | GRN | 6 |
| FGC21306 | GR00, WH00, BL00 | Swinger Loop® Shrinkless® Wet Mop | 1" | 10.8 lb | Large | 2.5 cm | 4.9 kg | RED | 6 |
| FGC25206 | GR00, WH00, BL00 | Swinger Loop® Shrinkless® Wet Mop | 5" | 7.7 lb | Medium | 12.7 cm | 3.5 kg | GRN | 6 |
| FGC25306 | GR00, WH00, BL00, OR00 | Swinger Loop® Shrinkless® Wet Mop | 5" | 10.9 lb | Large | 12.7 cm | 4.9 kg | RED | 6 |
| FGC25406 | WH00 | Swinger Loop® Shrinkless® Wet Mop | 5" | 13.1 lb | X-Large | 12.7 cm | 5.9 kg | BLUE | 6 |

Swinger Loop® Wet Mops

Looped-end, tailbanded mop for better floor coverage.

- Balanced 4-ply blend of cotton and synthetic yarn for absorbency and strength
- Launderable for long product life
- Recycled content: colors are up to 65% post-industrial cotton and 35% PET plastic
- **Shipped as compact mop packages**
- Standard launderability, up to 50 launderings



FGC15306

| NO. | COLOR | DESCRIPTION | U.S. HEADBAND SIZE | U.S. SHIP WT/CTN | MOP SIZE | METRIC HEADBAND SIZE | METRIC SHIP WT/CTN | HEADBAND COLOR | PACK |
|----------|------------------|-----------------------|--------------------|------------------|----------|----------------------|--------------------|----------------|------|
| FGC11106 | WH00 | Swinger Loop® Wet Mop | 1" | 4.5 lb | Small | 2.5 cm | 2 kg | YEL | 6 |
| FGC11206 | GR00, WH00, BL00 | Swinger Loop® Wet Mop | 1" | 6.0 lb | Medium | 2.5 cm | 2.7 kg | GRN | 6 |
| FGC11306 | GR00, WH00, BL00 | Swinger Loop® Wet Mop | 1" | 8.6 lb | Large | 2.5 cm | 3.9 kg | RED | 6 |
| FGC11406 | WH00 | Swinger Loop® Wet Mop | 1" | 10.9 lb | X-Large | 2.5 cm | 4.9 kg | BLUE | 6 |
| FGC15106 | GR00, BL00 | Swinger Loop® Wet Mop | 5" | 4.5 lb | Small | 12.7 cm | 2 kg | YEL | 6 |
| FGC15206 | GR00, WH00, BL00 | Swinger Loop® Wet Mop | 5" | 6.0 lb | Medium | 12.7 cm | 2.7 kg | GRN | 6 |
| FGC15306 | GR00, WH00, BL00 | Swinger Loop® Wet Mop | 5" | 8.6 lb | Large | 12.7 cm | 3.9 kg | RED | 6 |
| FGC15406 | WH00, BL00 | Swinger Loop® Wet Mop | 5" | 10.9 lb | X-Large | 12.7 cm | 4.9 kg | BLUE | 6 |

UTILITY REFUSE AND RECYCLING

DECORATIVE REFUSE

CLEANING

MATERIAL HANDLING

WASHROOM

FOODSERVICE

ACCESSORIES & INDEX



UTILITY REFUSE
AND RECYCLING

DECORATIVE REFUSE

CLEANING

MATERIAL HANDLING

WASHROOM

FOODSERVICE

ACCESSORIES
& INDEX



SCRUBBING WET MOP



INTEGRATED

SCRUBBING HEADBAND

Removes stuck-on debris 2x faster than a traditional Rubbermaid Commercial Products wet mop.



DURABLE & UNIVERSAL

Double-sided and securely sewn-in scrubbing headband is compatible with side-loading Invader® and clamp-style Gripper® handles.

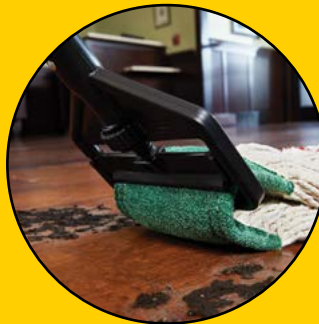

SAFE & EFFECTIVE

Designed for effective scrubbing without scratching on a variety of floor types, including laminate, linoleum, vinyl, and light and dark hardwood.

Swinger Loop® Finish Mops

Tightly twisted 8-ply yarn inhibits linting and provides a smooth, even application of floor finish.

- Tapeless tailband helps reduce streaking
- Compact mop packaging makes mop storage and inventory management more efficient
- Recycled content: 74% PET plastic
- **Shipped as compact mop packages**
- Standard launderability, up to 50 launderings



FGA41206

| NO. | COLOR | DESCRIPTION | U.S. HEADBAND SIZE | U.S. SHIP WT/CTN | MOP SIZE | METRIC HEADBAND SIZE | METRIC SHIP WT/CTN | HEADBAND COLOR | PACK |
|----------|-------|--------------------------|--------------------|------------------|----------|----------------------|--------------------|----------------|------|
| FGC41206 | WH00 | Swinger Loop® Finish Mop | 1" | 6.0 lb | Medium | 2.5 cm | 2.7 kg | WHT | 6 |
| FGC41306 | WH00 | Swinger Loop® Finish Mop | 1" | 8.6 lb | Large | 2.5 cm | 3.9 kg | WHT | 6 |

Super Stitch® Rayon Mops

Economical floor finish applicator.

- Looped ends and yarn tailband help reduce streaking
- Tightly twisted, 4-ply yarn helps reduce linting
- **Shipped as compact mop packages**
- Recycled content: up to 75% PET Plastic
- Limited launderability, or hand wash up to 50 launderings



FGD45306

| NO. | COLOR | DESCRIPTION | U.S. HEADBAND SIZE | U.S. SHIP WT/CTN | MOP SIZE | METRIC HEADBAND SIZE | METRIC SHIP WT/CTN | HEADBAND COLOR | PACK |
|----------|-------|-------------------------|--------------------|------------------|----------|----------------------|--------------------|----------------|------|
| FGD41206 | WH00 | Super Stitch® Rayon Mop | 1" | 5.9 lb | Medium | 2.5 cm | 2.7 kg | GRN | 6 |
| FGD41306 | WH00 | Super Stitch® Rayon Mop | 1" | 8.0 lb | Large | 2.5 cm | 3.6 kg | RED | 6 |
| FGD45306 | WH00 | Super Stitch® Rayon Mop | 5" | 8.0 lb | Large | 12.7 cm | 3.6 kg | RED | 6 |

Super Stitch® Cotton Scrubbing Wet Mops

The Scrubbing Wet Mop features an integrated scrubbing headband that removes stuck-on messes faster without interrupting the mopping process.

- Integrated scrubbing headband removes stuck-on debris 2x faster than a traditional Rubbermaid Commercial Products wet mop.
- Universal scrubbing headband is compatible with side-loading Invader® and clamp-style Gripper® handles.
- Double-sided and securely sewn-in scrubbing headband lasts the lifetime of the mop.
- Designed for effective scrubbing without scratching on a variety of floor types, including laminate, linoleum, vinyl, and light and dark hardwood



| NO. | COLOR | DESCRIPTION | U.S. HEADBAND SIZE | U.S. SHIP WT/CTN | MOP SIZE | METRIC HEADBAND SIZE | METRIC SHIP WT/CTN | HEADBAND COLOR | PACK |
|----------|-------|--|--------------------|------------------|----------|----------------------|--------------------|----------------|------|
| 2036121 | White | Super Stitch® Cotton Scrubbing Wet Mop | Universal | 8.07 lb | Large | Universal | 3.66 kg | Green | 6 |
| 2036123 | White | Super Stitch® Cotton Scrubbing Wet Mop | Universal | 6.75 lb | Medium | Universal | 3.06 kg | Green | 6 |
| 2036100 | White | Super Stitch® Cotton Scrubbing Wet Mop | Universal | 5.25 lb | Small | Universal | 2.38 kg | Green | 6 |
| FGD45306 | WH00 | Super Stitch® Rayon Mop | 5" | 8.0 lb | Large | 12.7 cm | 3.6 kg | Red | 6 |

UTILITY REFUSE AND RECYCLING

DECORATIVE REFUSE

CLEANING

MATERIAL HANDLING

WASHROOM

FOODSERVICE

ACCESSORIES & INDEX



Super Stitch® Cotton Mop

Economical, general-purpose mop.

- Looped-end 4-ply yarn with yarn tailband for greater coverage with each stroke
- Recycled content: up to 100% post-industrial cotton
- **Shipped as compact mop packages**
- Limited launderability, or hand wash up to 50 launderings



| NO. | COLOR | DESCRIPTION | U.S. HEADBAND SIZE | U.S. SHIP WT/CTN | MOP SIZE | METRIC HEADBAND SIZE | METRIC SHIP WT/CTN | HEADBAND COLOR | PACK |
|----------|-------------|---|--------------------|------------------|----------|----------------------|--------------------|----------------|------|
| FGD11306 | WH00 | Super Stitch® Cotton Looped-End Wet Mop | 1" | 7.6 lb | Large | 2.5 cm | 3.4 kg | RED | 6 |

Super Stitch® Finish Mops

Blend yarns for great absorbency and release.

- Bright blue and white yarn helps identify finish mop versus general-purpose mop
- Looped ends and yarn tailband help reduce streaking
- Tightly twisted, 4-ply polyester and rayon yarn helps reduce linting
- Recycled content: 74% PET plastic
- **Shipped as compact mop packages**
- Limited launderability, or hand wash up to 50 launderings



FGD55306

| NO. | COLOR | DESCRIPTION | U.S. HEADBAND SIZE | U.S. SHIP WT/CTN | MOP SIZE | METRIC HEADBAND SIZE | METRIC SHIP WT/CTN | HEADBAND COLOR | PACK |
|----------|-------------|--------------------------|--------------------|------------------|----------|----------------------|--------------------|----------------|------|
| FGD51206 | WH00 | Super Stitch® Finish Mop | 1" | 5.9 lb | Medium | 2.5 cm | 2.7 kg | BLUE | 6 |
| FGD51306 | WH00 | Super Stitch® Finish Mop | 1" | 5.9 lb | Large | 2.5 cm | 2.7 kg | BLUE | 6 |
| FGD55206 | WH00 | Super Stitch® Finish Mop | 5" | 5.9 lb | Medium | 12.7 cm | 3.6 kg | BLUE | 6 |
| FGD55306 | WH00 | Super Stitch® Finish Mop | 5" | 8.0 lb | Large | 12.7 cm | 3.6 kg | BLUE | 6 |

Super Stitch® Blend Scrubbing Wet Mops

The Scrubbing Wet Mop features an integrated scrubbing headband that removes stuck-on messes faster without interrupting the mopping process.

- Integrated scrubbing headband removes stuck-on debris 2x faster than a traditional Rubbermaid Commercial Products wet mop.
- Universal scrubbing headband is compatible with side-loading Invader® and clamp-style Gripper® handles.
- Double-sided and securely sewn-in scrubbing headband lasts the lifetime of the mop.
- Designed for effective scrubbing without scratching on a variety of floor types, including laminate, linoleum, vinyl, and light and dark hardwood.



| NO. | COLOR | DESCRIPTION | U.S. HEADBAND SIZE | U.S. SHIP WT/CTN | MOP SIZE | METRIC HEADBAND SIZE | METRIC SHIP WT/CTN | HEADBAND COLOR | PACK |
|---------|--------------|---------------------------------------|--------------------|------------------|----------|----------------------|--------------------|----------------|------|
| 2036096 | Blue | Super Stitch® Blend Scrubbing Wet Mop | Universal | 8.07 lb | Large | Universal | 3.66 kg | Green | 6 |
| 2036099 | Green | Super Stitch® Blend Scrubbing Wet Mop | Universal | 8.07 lb | Large | Universal | 3.66 kg | Green | 6 |
| 2036129 | Red | Super Stitch® Blend Scrubbing Wet Mop | Universal | 8.07 lb | Large | Universal | 3.66 kg | Green | 6 |
| 2036125 | White | Super Stitch® Blend Scrubbing Wet Mop | Universal | 8.07 lb | Large | Universal | 3.66 kg | Green | 6 |
| 2036127 | Blue | Super Stitch® Blend Scrubbing Wet Mop | Universal | 6.75 lb | Medium | Universal | 3.06 kg | Green | 6 |
| 2036124 | Green | Super Stitch® Blend Scrubbing Wet Mop | Universal | 6.75 lb | Medium | Universal | 3.06 kg | Green | 6 |
| 2036122 | Red | Super Stitch® Blend Scrubbing Wet Mop | Universal | 6.75 lb | Medium | Universal | 3.06 kg | Green | 6 |
| 2036128 | White | Super Stitch® Blend Scrubbing Wet Mop | Universal | 6.75 lb | Medium | Universal | 3.06 kg | Green | 6 |
| 2036098 | Blue | Super Stitch® Blend Scrubbing Wet Mop | Universal | 5.25 lb | Small | Universal | 2.38 kg | Green | 6 |
| 2036126 | Green | Super Stitch® Blend Scrubbing Wet Mop | Universal | 5.25 lb | Small | Universal | 2.38 kg | Green | 6 |
| 2036130 | White | Super Stitch® Blend Scrubbing Wet Mop | Universal | 5.25 lb | Small | Universal | 2.38 kg | Green | 6 |
| 2036097 | White | Super Stitch® Blend Scrubbing Wet Mop | Universal | 10.90 lb | X-Large | Universal | 4.94 kg | Green | 6 |

UTILITY REFUSE AND RECYCLING

DECORATIVE REFUSE

CLEANING

MATERIAL HANDLING

WASHROOM

FOODSERVICE

ACCESSORIES & INDEX

Super Stitch® Blend Mops

Outperforms and outlasts premium cut-end mops 2 to 1.

- Balanced blend of cotton and synthetic yarns for absorbency and strength
- Looped ends and yarn tailband provide greater floor coverage
- Recycled content: colors are up to 65% post-industrial cotton and 35% PET plastic
- Shipped as compact mop packages
- Limited launderability, or hand wash up to 50 launderings



FGD25206



| NO. | COLOR | DESCRIPTION | U.S. HEADBAND SIZE | U.S. SHIP WT/CTN | MOP SIZE | METRIC HEADBAND SIZE | METRIC SHIP WT/CTN | HEADBAND COLOR | PACK |
|----------|-------------------------|-------------------------|--------------------|------------------|----------|----------------------|--------------------|----------------|------|
| FGD21106 | WH00, BL00 | Super Stitch® Blend Mop | 1" | 4.0 lb | Small | 2.5 cm | 1.8 kg | YEL | 6 |
| FGD21206 | GR00*, RD00, WH00, BL00 | Super Stitch® Blend Mop | 1" | 5.9 lb | Medium | 2.5 cm | 2.7 kg | GRN | 6 |
| FGD21306 | GR00, RD00, WH00*, BL00 | Super Stitch® Blend Mop | 1" | 8.0 lb | Large | 2.5 cm | 3.6 kg | RED | 6 |
| FGD21406 | WH00 | Super Stitch® Blend Mop | 1" | 10.7 lb | X-Large | 2.5 cm | 4.9 kg | BLUE | 6 |
| FGD25106 | WH00, BL00 | Super Stitch® Blend Mop | 5" | 4.0 lb | Small | 12.7 cm | 1.8 kg | YEL | 6 |
| FGD25206 | GR00, RD00, WH00, BL00 | Super Stitch® Blend Mop | 5" | 5.9 lb | Medium | 12.7 cm | 2.7 kg | GRN | 6 |
| FGD25306 | GR00, RD00, WH00, BL00 | Super Stitch® Blend Mop | 5" | 8.0 lb | Large | 12.7 cm | 3.6 kg | RED | 6 |
| FGD25406 | WH00 | Super Stitch® Blend Mop | 5" | 11.5 lb | X-Large | 12.7 cm | 5.2 kg | BLUE | 6 |

*Available in Bolt-On Headband 12-pack.

Universal Headband Blue Blend Mops

Cotton/synthetic yarn blend has almost twice the absorbency of cotton.

- Looped ends reduce fraying associated with cut-end mops
- Universal headband fits both side-loading and clamp-style handles
- Recycled content: up to 65% post-industrial cotton and 35% PET plastic
- Limited launderability, or hand wash up to 50 launderings



FGE23900



| NO. | COLOR | DESCRIPTION | U.S. HEADBAND SIZE | U.S. SHIP WT/CTN | MOP SIZE | METRIC HEADBAND SIZE | METRIC SHIP WT/CTN | HEADBAND COLOR | PACK |
|----------|-------|-----------------------------------|--------------------|------------------|----------|----------------------|--------------------|----------------|------|
| FGE23600 | BL00 | Universal Headband Blue Blend Mop | Universal | 13.0 lb | 16 oz | 0.5 kg | 5.9 kg | BLUE | 12 |
| FGE23800 | BL00 | Universal Headband Blue Blend Mop | Universal | 19.0 lb | 24 oz | 0.7 kg | 8.6 kg | BLUE | 12 |
| FGE23900 | BL00 | Universal Headband Blue Blend Mop | Universal | 25.0 lb | 32 oz | 0.9 kg | 11.3 kg | BLUE | 12 |

Universal Headband Rayon Mops

Ideal for floor finish application.

- Looped ends reduce linting and depling
- Universal headband fits both side-loading and clamp-style handles
- Recycled content: up to 75%
- Limited launderability, or hand wash up to 50 launderings



FGE43800



| NO. | COLOR | DESCRIPTION | U.S. HEADBAND SIZE | U.S. SHIP WT/CTN | MOP SIZE | METRIC HEADBAND SIZE | METRIC SHIP WT/CTN | HEADBAND COLOR | PACK |
|----------|-------|------------------------------|--------------------|------------------|----------|----------------------|--------------------|----------------|------|
| FGE43600 | WH00 | Universal Headband Rayon Mop | Universal | 13.0 lb | 16 oz | 0.5 kg | 5.9 kg | BLUE | 12 |
| FGE43800 | WH00 | Universal Headband Rayon Mop | Universal | 19.0 lb | 24 oz | 0.7 kg | 8.6 kg | BLUE | 12 |

UTILITY REFUSE AND RECYCLING

DECORATIVE REFUSE

CLEANING

MATERIAL HANDLING

WASHROOM

FOODSERVICE

ACCESSORIES & INDEX



Universal Headband Cotton Mops

Excellent, all-purpose mop for general cleaning.

- Looped ends reduce fraying associated with cut-end mops
- Universal headband fits both side-loading and clamp-style handles
- Recycled content: up to 100% post-industrial cotton
- Limited launderability, or hand wash up to 50 launderings



FGE13900

| NO. | COLOR | DESCRIPTION | U.S. HEADBAND SIZE | U.S. SHIP WT/ CTN | MOP SIZE | METRIC HEADBAND SIZE | METRIC SHIP WT/CTN | HEADBAND COLOR | PACK |
|----------|-------------|-------------------------------|--------------------|-------------------|----------|----------------------|--------------------|----------------|------|
| FGE13600 | WH00 | Universal Headband Cotton Mop | Universal | 12.0 lb | 16 oz | 0.5 kg | 5.4 kg | BLUE | 12 |
| FGE13800 | WH00 | Universal Headband Cotton Mop | Universal | 18.0 lb | 24 oz | 0.7 kg | 8.2 kg | BLUE | 12 |
| FGE13900 | WH00 | Universal Headband Cotton Mop | Universal | 24.0 lb | 32 oz | 0.9 kg | 10.9 kg | BLUE | 12 |

Dura Pro Blend Mops

Cut-end, 4-ply cotton/rayon/synthetic yarn blend for good performance and durability.

- Outlasts and outperforms cotton
- Excellent absorbency
- Narrow and wide headbands available (1" and 5")
- Recycled content: colors are up to 65% post-industrial cotton and 35% PET plastic
- Nonlaunderable, bucket wash/wring only



FGF55800

| NO. | COLOR | DESCRIPTION | U.S. HEADBAND SIZE | U.S. SHIP WT/ CTN | U.S. MOP SIZE | METRIC HEADBAND SIZE | METRIC SHIP WT/CTN | METRIC MOP SIZE | HEADBAND COLOR | PACK |
|----------|-------------------|---------------------------|--------------------|-------------------|---------------|----------------------|--------------------|-----------------|----------------|------|
| FGF51600 | BLOO | Premium Cut-End Blend Mop | 1" | 13.0 lb | 16 oz | 2.5 cm | 5.9 kg | 0.5 kg | ORAN | 12 |
| FGF51700 | WH00, BLOO | Premium Cut-End Blend Mop | 1" | 16.0 lb | 20 oz | 2.5 cm | 7.3 kg | 0.6 kg | ORAN | 12 |
| FGF51800 | WH00, BLOO | Premium Cut-End Blend Mop | 1" | 19.0 lb | 24 oz | 2.5 cm | 8.6 kg | 0.7 kg | ORAN | 12 |
| FGF51900 | BLOO | Premium Cut-End Blend Mop | 1" | 25.0 lb | 32 oz | 2.5 cm | 11.3 kg | 0.9 kg | ORAN | 12 |
| FGF55600 | BLOO | Premium Cut-End Blend Mop | 5" | 13.0 lb | 16 oz | 12.7 cm | 5.9 kg | 0.5 kg | BLUE | 12 |
| FGF55700 | BLOO | Premium Cut-End Blend Mop | 5" | 16.0 lb | 20 oz | 12.7 cm | 7.3 kg | 0.6 kg | BLUE | 12 |
| FGF55800 | BLOO | Premium Cut-End Blend Mop | 5" | 19.0 lb | 24 oz | 12.7 cm | 8.6 kg | 0.7 kg | BLUE | 12 |

Dura Pro Rayon Mops

Economical, 4-ply cut-end mop for floor finish applications.

- Excellent absorbency and release characteristics
- For economical floor finish applications
- Recycled content: up to 75%
- Nonlaunderable, bucket wash/wring only



FGF41800

| NO. | COLOR | DESCRIPTION | U.S. HEADBAND SIZE | U.S. SHIP WT/ CTN | U.S. MOP SIZE | METRIC HEADBAND SIZE | METRIC SHIP WT/CTN | METRIC MOP SIZE | HEADBAND COLOR | PACK |
|----------|-------------|---------------------------|--------------------|-------------------|---------------|----------------------|--------------------|-----------------|----------------|------|
| FGF41600 | WH00 | Premium Cut-End Rayon Mop | 1" | 13.0 lb | 16 oz | 2.5 cm | 5.9 kg | 0.5 kg | ORAN | 12 |
| FGF41700 | WH00 | Premium Cut-End Rayon Mop | 1" | 16.0 lb | 20 oz | 2.5 cm | 7.3 kg | 0.6 kg | ORAN | 12 |
| FGF41800 | WH00 | Premium Cut-End Rayon Mop | 1" | 19.0 lb | 24 oz | 2.5 cm | 8.6 kg | 0.7 kg | ORAN | 12 |
| FGF41900 | WH00 | Premium Cut-End Blend Mop | 1" | 24.0 lb | | 2.5 cm | 11.3 kg | | ORAN | 6 |
| FGF55900 | BLOO | Premium Cut-End Blend Mop | 5" | 24.0 lb | | 12.7 cm | 11.3 kg | | BLUE | 6 |

UTILITY REFUSE AND RECYCLING

DECORATIVE REFUSE

CLEANING

MATERIAL HANDLING

WASHROOM

FOODSERVICE

ACCESSORIES & INDEX

Disposable Wet Mops

The new Disposable Mop from Rubbermaid Commercial Products helps workers reduce the spread of dirt and grime, resulting in cleaner floors. Engineered with hydrophilic, non-woven material, the RCP Disposable Mop is designed for one-time use to deliver a consistent clean shift after shift.

- Removes 3X More Dirt and Grease* (*Versus RCP economy cotton mops)
- No Break-In Period for Immediate Peak Performance
- Reduced Quat Binding* (*Versus used RCP economy cotton mops after 8-hour Quat exposure)
- Reduced linting* (*Versus RCP economy cotton mops)
- Product Made From 99% Recycled Material
- Tailband for Maximum Spread and Consistent Floor Coverage
- Safe for Floor Stripping



| NO. | COLOR | DESCRIPTION | U.S. HEADBAND SIZE | U.S. SHIP WT/CTN | U.S. MOP SIZE | METRIC HEADBAND SIZE | METRIC SHIP WT/CTN | HEADBAND COLOR | PACK |
|---------|-------|--------------------|--------------------|------------------|---------------|----------------------|--------------------|----------------|------|
| 2025501 | White | Disposable Wet Mop | 1" | 7.30 lb | #16 | 2.5 cm | 3.32 kg | White | 24 |
| 2025502 | White | Disposable Wet Mop | 1" | 8.65 lb | #20 | 2.5 cm | 3.92 kg | White | 24 |
| 2025503 | White | Disposable Wet Mop | 1" | 10.25 lb | #24 | 2.5 cm | 4.65 kg | White | 24 |
| 2025504 | White | Disposable Wet Mop | 1" | 11.65 lb | #32 | 2.5 cm | 5.28 kg | White | 24 |
| 2025505 | White | Disposable Wet Mop | 5" | 7.40 lb | #16 | 12.7 cm | 3.36 kg | WHITE | 24 |
| 2025506 | White | Disposable Wet Mop | 5" | 8.95 lb | #20 | 12.7 cm | 4.06 kg | WHITE | 24 |
| 2025507 | White | Disposable Wet Mop | 5" | 10.55 lb | #24 | 12.7 cm | 4.79 kg | WHITE | 24 |
| 2025508 | White | Disposable Wet Mop | 5" | 11.90 lb | #32 | 12.7 cm | 5.40 kg | WHITE | 24 |

Dura Pro Cotton Mops

Economical, 4-ply cut-end mop for general-purpose cleaning.

- Absorbent 4-ply cotton for general-purpose mopping
- Narrow and wide headbands available (1" and 5")
- Recycled content: up to 100% post-industrial cotton
- Shipped as compact mop packages
- Nonlaunderable, bucket wash/wring only



FGF15800

| NO. | COLOR | DESCRIPTION | U.S. HEADBAND SIZE | U.S. SHIP WT/CTN | U.S. MOP SIZE | METRIC HEADBAND SIZE | METRIC SHIP WT/CTN | METRIC MOP SIZE | HEADBAND COLOR | PACK |
|----------|-------|----------------------------|--------------------|------------------|---------------|----------------------|--------------------|-----------------|----------------|------|
| FGF11600 | WH00 | Premium Cut-End Cotton Mop | 1" | 12.0 lb | 16 oz | 2.5 cm | 5.4 kg | 0.5 kg | ORAN | 12 |
| FGF11700 | WH00 | Premium Cut-End Cotton Mop | 1" | 15.0 lb | 20 oz | 2.5 cm | 6.8 kg | 0.6 kg | ORAN | 12 |
| FGF11800 | WH00 | Premium Cut-End Cotton Mop | 1" | 18.0 lb | 24 oz | 2.5 cm | 8.2 kg | 0.7 kg | ORAN | 12 |
| FGF11900 | WH00 | Premium Cut-End Cotton Mop | 1" | 24.0 lb | 32 oz | 2.5 cm | 10.9 kg | 0.9 kg | ORAN | 12 |
| FGF15600 | WH00 | Premium Cut-End Cotton Mop | 5" | 12.0 lb | 16 oz | 12.7 cm | 5.4 kg | 0.5 kg | BLUE | 12 |
| FGF15700 | WH00 | Premium Cut-End Cotton Mop | 5" | 15.0 lb | 20 oz | 12.7 cm | 6.8 kg | 0.6 kg | BLUE | 12 |
| FGF15800 | WH00 | Premium Cut-End Cotton Mop | 5" | 18.0 lb | 24 oz | 12.7 cm | 8.2 kg | 0.7 kg | BLUE | 12 |
| FGF15900 | WH00 | Premium Cut-End Cotton Mop | 5" | 24.0 lb | 32 oz | 12.7 cm | 10.9 kg | 0.9 kg | BLUE | 12 |



Value Pro Cut-End Cotton and Rayon Wet Mops

Cotton mop for general, all-purpose cleaning; rayon mop for finish application

- Available in narrow and wide headbands (1" and 5")
- Recycled content: up to 100% post-industrial cotton
- Actual weight may vary by 2 oz.
- Shipped as compact mop packages
- Nonlaunderable, bucket wash/wring only



FGV15700

Value Pro Cotton Mops

| NO. | COLOR | DESCRIPTION | U.S. HEADBAND SIZE | U.S. SHIP WT/ CTN | U.S. MOP SIZE | METRIC HEADBAND SIZE | METRIC SHIP WT/ CTN | METRIC MOP SIZE | HEADBAND COLOR | PACK |
|----------|-------------|----------------------------|--------------------|-------------------|---------------|----------------------|---------------------|-----------------|----------------|------|
| FGV11600 | WH00 | Economy Cotton Cut-End Mop | 1" | 10.1 lb | #16 | 2.5 cm | 4.6 kg | N/A | WHT | 12 |
| FGV11700 | WH00 | Economy Cotton Cut-End Mop | 1" | 13.1 lb | #20 | 2.5 cm | 5.9 kg | N/A | WHT | 12 |
| FGV11800 | WH00 | Economy Cotton Cut-End Mop | 1" | 15.8 lb | #24 | 2.5 cm | 7.2 kg | N/A | WHT | 12 |
| FGV11900 | WH00 | Economy Cotton Cut-End Mop | 1" | 21.0 lb | #32 | 2.5 cm | 9.5 kg | N/A | WHT | 12 |
| FGV15600 | WH00 | Economy Cotton Cut-End Mop | 5" | 10.2 lb | #16 | 12.7 cm | 4.6 kg | N/A | WHT | 12 |
| FGV15700 | WH00 | Economy Cotton Cut-End Mop | 5" | 13.1 lb | #20 | 12.7 cm | 5.9 kg | N/A | WHT | 12 |
| FGV15800 | WH00 | Economy Cotton Cut-End Mop | 5" | 15.8 lb | #24 | 12.7 cm | 7.2 kg | N/A | WHT | 12 |
| FGV15900 | WH00 | Economy Cotton Cut-End Mop | 5" | 21.0 lb | #32 | 12.7 cm | 9.5 kg | N/A | WHT | 12 |

Value Pro Rayon Mops

| NO. | COLOR | DESCRIPTION | U.S. HEADBAND SIZE | U.S. SHIP WT/ CTN | U.S. MOP SIZE | METRIC HEADBAND SIZE | METRIC SHIP WT/ CTN | METRIC MOP SIZE | HEADBAND COLOR | PACK |
|----------|-------------|---------------------------|--------------------|-------------------|---------------|----------------------|---------------------|-----------------|----------------|------|
| FGV41600 | WH00 | Economy Rayon Cut-End Mop | 1" | 12.0 lb | #16 | 2.5 cm | 5.4 kg | N/A | WHT | 12 |
| FGV41700 | WH00 | Economy Rayon Cut-End Mop | 1" | 15.0 lb | #20 | 2.5 cm | 6.8 kg | N/A | WHT | 12 |
| FGV41800 | WH00 | Economy Rayon Cut-End Mop | 1" | 18.0 lb | #24 | 2.5 cm | 8.2 kg | N/A | WHT | 12 |
| FGV41900 | WH00 | Economy Rayon Cut-End Mop | 1" | 23.0 lb | #32 | 2.5 cm | 10.4 kg | N/A | WHT | 12 |

Bolt-On Cut-End Blend Mops

Cut-end mop with screw-on head for general-purpose mopping.

- Blend of 4-ply cotton/rayon/synthetic
- Enhanced mop-to-floor contact
- Recycled content: colors are up to 65% post-industrial cotton and 35% PET plastic
- Nonlaunderable, bucket wash/wring only



FGF56800

| NO. | COLOR | DESCRIPTION | U.S. HEADBAND SIZE | U.S. SHIP WT/ CTN | U.S. MOP SIZE | METRIC HEADBAND SIZE | METRIC SHIP WT/ CTN | METRIC MOP SIZE | HEADBAND COLOR | PACK |
|----------|-------------|-----------------------------------|--------------------|-------------------|---------------|----------------------|---------------------|-----------------|----------------|------|
| FGF56600 | BL00 | Premium Bolt-On Cut-End Blend Mop | N/A | 13.0 lb | 16 oz | N/A | 5.9 kg | 0.5 kg | N/A | 12 |
| FGF56700 | BL00 | Premium Bolt-On Cut-End Blend Mop | N/A | 16.0 lb | 20 oz | N/A | 7.3 kg | 0.6 kg | N/A | 12 |
| FGF56800 | BL00 | Premium Bolt-On Cut-End Blend Mop | N/A | 19.0 lb | 24 oz | N/A | 8.6 kg | 0.7 kg | N/A | 12 |

Bolt-On Cut-End Rayon Mops

Cut-end mop for finish applications.

- Cut-end, 4-ply rayon yarn
- Enhanced mop-to-floor contact
- Recycled content: up to 75%
- Nonlaunderable, bucket wash/wring only



FGF46800

| NO. | COLOR | DESCRIPTION | U.S. HEADBAND SIZE | U.S. SHIP WT/ CTN | U.S. MOP SIZE | METRIC HEADBAND SIZE | METRIC SHIP WT/ CTN | METRIC MOP SIZE | HEADBAND COLOR | PACK |
|----------|-------------|-----------------------------------|--------------------|-------------------|---------------|----------------------|---------------------|-----------------|----------------|------|
| FGF46700 | WH00 | Premium Bolt-On Cut-End Rayon Mop | N/A | 16.0 lb | 20 oz | N/A | 7.3 kg | 0.6 kg | N/A | 12 |
| FGF46800 | WH00 | Premium Bolt-On Cut-End Rayon Mop | N/A | 19.0 lb | 24 oz | N/A | 8.6 kg | 0.7 kg | N/A | 12 |

UTILITY REFUSE AND RECYCLING

DECORATIVE REFUSE

CLEANING

MATERIAL HANDLING

WASHROOM

FOODSERVICE

ACCESSORIES & INDEX

Bolt-On Cut-End Cotton Mops

Cut-end mop with screw-on head for general-purpose mopping.

- Absorbent 4-ply cotton yarn
- Enhanced mop-to-floor contact
- Recycled content: up to 100% post-industrial cotton
- Nonlaunderable, bucket wash/wring only



FGF16800

| NO. | COLOR | DESCRIPTION | U.S. HEADBAND SIZE | U.S. SHIP WT/CTN | U.S. MOP SIZE | METRIC HEADBAND SIZE | METRIC SHIP WT/CTN | METRIC MOP SIZE | HEADBAND COLOR | PACK |
|----------|-------|------------------------------------|--------------------|------------------|---------------|----------------------|--------------------|-----------------|----------------|------|
| FGF16600 | WH00 | Premium Bolt-On Cut-End Cotton Mop | N/A | 13.0 lb | 16 oz | N/A | 5.9 kg | 0.5 kg | N/A | 12 |
| FGF16700 | WH00 | Premium Bolt-On Cut-End Cotton Mop | N/A | 16.0 lb | 20 oz | N/A | 7.3 kg | 0.6 kg | N/A | 12 |
| FGF16800 | WH00 | Premium Bolt-On Cut-End Cotton Mop | N/A | 19.0 lb | 24 oz | N/A | 8.6 kg | 0.7 kg | N/A | 12 |

8-Ply Cut-End Cotton Mops

Economical, 8-ply cut-end mop for general-purpose cleaning.

- Abrasion-resistant, long-lasting 8-ply cotton
- Recycled content: up to 100% post-industrial cotton
- Nonlaunderable, bucket wash/wring



FGF21800

| NO. | COLOR | DESCRIPTION | U.S. HEADBAND SIZE | U.S. SHIP WT/CTN | U.S. MOP SIZE | METRIC HEADBAND SIZE | METRIC SHIP WT/CTN | METRIC MOP SIZE | HEADBAND COLOR | PACK |
|----------|-------|----------------------------------|--------------------|------------------|---------------|----------------------|--------------------|-----------------|----------------|------|
| FGF21600 | WH00 | Premium 8-Ply Cut-End Cotton Mop | 1" | 13.0 lb | 16 oz | 2.5 cm | 5.9 kg | 0.5 kg | ORAN | 12 |
| FGF21700 | WH00 | Premium 8-Ply Cut-End Cotton Mop | 1" | 16.0 lb | 20 oz | 2.5 cm | 7.3 kg | 0.6 kg | ORAN | 12 |
| FGF21800 | WH00 | Premium 8-Ply Cut-End Cotton Mop | 1" | 19.0 lb | 24 oz | 2.5 cm | 8.6 kg | 0.7 kg | ORAN | 12 |
| FGF21900 | WH00 | Premium 8-Ply Cut-End Cotton Mop | 1" | 25.0 lb | 32 oz | 2.5 cm | 11.3 kg | 0.9 kg | ORAN | 12 |

Synthetic Blend Mops

Economical, cut-end wet mop for general cleaning.

- All-synthetic mop yarn resists abrasive floor surfaces, such as quarry tile, for long-lasting performance
- Yarn blend absorbs 4 to 5 times the mop's weight
- Colors are perfect for a color-coding system and resist mop graying for long-lasting, like-new appearance
- Available in compact packages
- Recycled content: up to 70% post-consumer PET plastic
- Nonlaunderable, bucket wash/wring only



FGF13100

| NO. | COLOR | DESCRIPTION | U.S. HEADBAND SIZE | U.S. SHIP WT/CTN | U.S. MOP SIZE | METRIC HEADBAND SIZE | METRIC SHIP WT/CTN | METRIC MOP SIZE | HEADBAND COLOR | PACK |
|----------|------------------|---------------------|--------------------|------------------|---------------|----------------------|--------------------|-----------------|----------------|------|
| FGF13100 | PINK, GR00, BL00 | Synthetic Blend Mop | 1" | 6.0 lb | 16 oz | 2.5 cm | 2.7 kg | 0.5 kg | WHT | 6 |
| FGF13200 | GR00, BL00 | Synthetic Blend Mop | 1" | 8.6 lb | 24 oz | 2.5 cm | 3.9 kg | 0.7 kg | WHT | 6 |
| FGF13600 | GR00, BL00 | Synthetic Blend Mop | 5" | 6.0 lb | 16 oz | 12.7 cm | 2.7 kg | 0.5 kg | WHT | 6 |
| FGF13700 | PINK, GR00, BL00 | Synthetic Blend Mop | 5" | 8.6 lb | 24 oz | 12.7 cm | 3.9 kg | 0.7 kg | WHT | 6 |

UTILITY REFUSE AND RECYCLING

DECORATIVE REFUSE

CLEANING

MATERIAL HANDLING

WASHROOM

FOODSERVICE

ACCESSORIES & INDEX



UTILITY REFUSE AND RECYCLING

DECORATIVE REFUSE

CLEANING

MATERIAL HANDLING

WASHROOM

FOODSERVICE

ACCESSORIES & INDEX

Clean Room Maintenance Mops

Looped-end, tailbanded mop for greater floor coverage with each stroke.

- For use in Class 10,000 and higher industrial applications, such as paint booths and pharmaceutical labs
- Made of woven, rayon/polyester fabric that will not fray or lint
- Launderable and preshrunk for long product life
- Premium launderability, up to 75 launderings



FGT30100

| NO. | COLOR | DESCRIPTION | U.S. HEADBAND SIZE | U.S. SHIP WT/ CTN | U.S. MOP SIZE | METRIC HEADBAND SIZE | METRIC SHIP WT/ CTN | METRIC MOP SIZE | HEADBAND COLOR | PACK |
|----------|-------------|----------------|--------------------|-------------------|---------------|----------------------|---------------------|-----------------|----------------|------|
| FGT30000 | WH00 | Clean Room Mop | 5" | 13.0 lb | 16 oz | 2.7 cm | 5.9 kg | 0.5 kg | GRN | 12 |
| FGT30100 | WH00 | Clean Room Mop | 5" | 19.0 lb | 24 oz | 2.7 cm | 8.6 kg | 0.7 kg | RED | 12 |

Rough-Floor Wet Mops

Economical choice for abrasive floor surfaces.

- Knitted fleece cotton/polyester blend yarn has twice the absorbency of cotton
- Excels on abrasive floor surfaces, such as nonslip/nonskid, stone, terrazzo, concrete, and other textured floor surfaces
- Looped ends and tailband aid in launderability
- Headband is compatible with Clamp-Style Wet Mop Handle
- Premium launderability, up to 75 launderings



FGT25600

| NO. | COLOR | DESCRIPTION | U.S. HEADBAND SIZE | U.S. SHIP WT/ CTN | U.S. MOP SIZE | METRIC HEADBAND SIZE | METRIC SHIP WT/ CTN | METRIC MOP SIZE | HEADBAND COLOR | PACK |
|----------|-------------|---------------------|--------------------|-------------------|---------------|----------------------|---------------------|-----------------|----------------|------|
| FGT25500 | WH00 | Rough-Floor Wet Mop | 5" | 12.0 lb | Medium | 2.7 cm | 5.4 kg | N/A | GRN | 12 |
| FGT25600 | WH00 | Rough-Floor Wet Mop | 5" | 15.0 lb | Large | 2.7 cm | 6.8 kg | N/A | RED | 12 |

Nylon Finish Mops

Nonlinting, continuous-filament yarn leaves an even, glossy, long-lasting finish every time.

- Innovative looped-end yarn construction holds finish for an even, efficient release
- Mop glides effortlessly across floor surface
- Premium launderability, up to 75 launderings



FGT20106

| NO. | COLOR | DESCRIPTION | U.S. HEADBAND SIZE | U.S. SHIP WT/ CTN | U.S. MOP SIZE | METRIC HEADBAND SIZE | METRIC SHIP WT/ CTN | METRIC MOP SIZE | HEADBAND COLOR | PACK |
|----------|-------------|------------------|--------------------|-------------------|---------------|----------------------|---------------------|-----------------|----------------|------|
| FGT20006 | WH00 | Nylon Finish Mop | 1" | 7.1 lb | Medium | 2.5 cm | 3.2 kg | Medium | N/A | 6 |
| FGT20106 | WH00 | Nylon Finish Mop | 1" | 9.9 lb | Large | 2.5 cm | 4.5 kg | Large | N/A | 6 |

Wet Mop Handles

Invader® and Gripper® Wet Mop Handles make removing and replacing mop heads easy and efficient.

- Invader® Side-Gate Handle's thumbwheel clamps the mop firmly in place; should be used with 1" headband mops
- Gripper® Clamp-Style Handles hold mop firmly between the jaws of the mop handle; should be used with 5" headband mops only
- Hardwood, Aluminum, and Fiberglass for all applications



Bamboo composite handles support sustainable mopping.



Invader® Side-Gate Handles



Invader® Side-Gate Style Wet Mop Handles

| NO. | COLOR | DESCRIPTION | U.S. DIMENSIONS | U.S. SHIP WT/CTN | METRIC DIMENSIONS | METRIC SHIP WT/CTN | PACK |
|----------|------------------------|---|--------------------|------------------|-----------------------|--------------------|------|
| FGH11500 | 0000 | Invader® Side-Gate Wet Mop Handle, Large Yellow Plastic Head, Hardwood Handle | 54" l | 13.0 lb | 137.2 cm | 5.9 kg | 12 |
| FGH11600 | 0000 | Invader® Side-Gate Wet Mop Handle, Large Yellow Plastic Head, Hardwood Handle | 60" l | 15.0 lb | 152.4 cm | 6.8 kg | 12 |
| FGH12500 | 0000 | Invader® Side-Gate Wet Mop Handle, Large Yellow Plastic Head, Gray Aluminum Handle | 54" l | 11.0 lb | 137.2 cm | 5 kg | 12 |
| FGH12600 | 0000 | Invader® Side-Gate Wet Mop Handle, Large Yellow Plastic Head, Gray Aluminum Handle | 60" l | 12.0 lb | 152.4 cm | 5.4 kg | 12 |
| FGH13500 | 0000 | Invader® Side-Gate Wet Mop Handle, Large Yellow Plastic Head, Vinyl-Covered Aluminum Handle | 54" l | 15.0 lb | 137.2 cm | 6.8 kg | 12 |
| FGH13600 | 0000 | Invader® Side-Gate Wet Mop Handle, Large Yellow Plastic Head, Vinyl-Covered Aluminum Handle | 60" l | 17.0 lb | 152.4 cm | 7.7 kg | 12 |
| FGH14500 | 0000 | Invader® Side-Gate Wet Mop Handle, Large Yellow Plastic Head, Fiberglass Handle | 54" l | 15.0 lb | 137.2 cm | 6.8 kg | 12 |
| FGH14600 | GY00, GR00, RD00, BL00 | Invader® Side-Gate Wet Mop Handle, Large Yellow Plastic Head, Fiberglass Handle | 60" l | 17.0 lb | 152.4 cm | 7.7 kg | 12 |
| 1863903 | BLACK | Executive 60" Fiberglass Mop Handle and Invader® Side-Gate Frame – String Mop | 60" l | 17.0 lb | 152.4 cm | 7.7 kg | 12 |
| FGH51600 | 0000 | Easy-Change Wet Mop Handle, Large Steel Head, Wood Handle | 60" l x 1 1/8" dia | 31.0 lb | 2.9 cm dia x 152.4 cm | 14.1 kg | 12 |



Gripper® Clamp-Style Handles



Gripper® Clamp-Style Wet Mop Handles

| NO. | COLOR | DESCRIPTION | U.S. DIMENSIONS | U.S. SHIP WT/CTN | METRIC DIMENSIONS | METRIC SHIP WT/CTN | PACK |
|----------|------------------------|--|-----------------|------------------|-------------------|--------------------|------|
| FGH21500 | 0000 | Gripper® Clamp-Style Wet Mop Handle, Plastic Yellow Head, Hardwood Handle | 54" l | 13.0 lb | 137.2 cm | 5.9 kg | 12 |
| FGH21600 | 0000 | Gripper® Clamp-Style Wet Mop Handle, Plastic Yellow Head, Hardwood Handle | 60" l | 15.0 lb | 152.4 cm | 6.8 kg | 12 |
| 1863901 | BLACK | Executive 60" Fiberglass Mop Handle and Gripper® Clamp Frame – String Mop | 60" l | 16.9 lb | 152.4 cm | 7.7 kg | 12 |
| FGH22500 | 0000 | Gripper® Clamp-Style Wet Mop Handle, Plastic Yellow Head, Gray Aluminum Handle | 54" l | 11.0 lb | 137.2 cm | 5 kg | 12 |
| FGH22600 | 0000 | Gripper® Clamp-Style Wet Mop Handle, Plastic Yellow Head, Gray Aluminum Handle | 60" l | 12.0 lb | 152.4 cm | 5.4 kg | 12 |
| FGH23600 | 0000 | Gripper® Clamp-Style Wet Mop Handle, Plastic Yellow Head, Vinyl-Coated Aluminum Handle | 60" l | 17.0 lb | 152.4 cm | 7.7 kg | 12 |
| FGH24500 | 0000 | Gripper® Clamp-Style Wet Mop Handle, Plastic Yellow Head, Fiberglass Handle | 54" l | 15.0 lb | 137.2 cm | 6.8 kg | 12 |
| FGH24600 | GY00, GR00, RD00, BL00 | Gripper® Clamp-Style Wet Mop Handle, Plastic Yellow Head, Fiberglass Handle | 60" l | 17.0 lb | 152.4 cm | 7.7 kg | 12 |



Adjustable Mop Handles

Designed to help reduce the physical strain of mopping.

- Unique handle grip swivels radially a full 360° in either direction to help reduce wrist strain
- Corrosion-resistant aluminum handle adjusts from 54" to 66" for maximum reach
- User-friendly bent handle minimizes the force and leverage required for smooth mopping
- Available with a clamp-style head that accommodates a 5" headband mop or side-gate head that accommodates a 1" headband mop



FGH12400



| NO. | COLOR | DESCRIPTION | U.S. DIMENSIONS | U.S. SHIP WT/CTN | METRIC DIMENSIONS | METRIC SHIP WT/CTN | PACK |
|----------|-------------|--|-----------------|------------------|---------------------|--------------------|------|
| FGH12400 | 0000 | User-Friendly Mop Handle with Side-Gate Head | 54"-66" l | 11 lb | 137.2 cm – 167.6 cm | 5 kg | 12 |

Laundry Net

Helps protect mops, microfiber pads, and other cleaning items during laundering.

- Locking closure keeps pads and cloths secure
- Provides easy organization for multiple cleaning crews



FGU21000

| NO. | COLOR | DESCRIPTION | U.S. DIMENSIONS | U.S. SHIP WT/CTN | METRIC DIMENSIONS | METRIC SHIP WT/CTN | PACK |
|----------|-------------|--|-----------------|------------------|-------------------|--------------------|------|
| FGU21000 | WH00 | Laundry Net, Synthetic Mesh Bag with Locking Closure | 36" l x 24" w | 6 lb | 91.4 cm x 61 cm | 2.7 kg | 12 |

BRUTE® Buckets

Heavy-duty thick-walled construction.

- BRUTE® buckets have molded-in graduations for accurate measuring
- Corrosion-resistant bails with comfortable plastic grip



FG261400



FG296300



1867341

| NO. | COLOR | DESCRIPTION | U.S. DIMENSIONS | U.S. CAPACITY | U.S. SHIP WT/CTN | METRIC DIMENSIONS | METRIC CAPACITY | METRIC SHIP WT/CTN | PACK |
|----------|------------------|--------------------------|----------------------|---------------|------------------|-----------------------|-----------------|--------------------|------|
| FG261400 | RED, GRAY | Round Bucket | 12" dia x 11.25" h | 14 qt | 10.7 lb | 30.5 cm dia x 28.6 cm | 13.2L | 4.9 kg | 6 |
| FG296300 | RED, GRAY | Round Bucket | 10.5" dia x 10.25" h | 10 qt | 14.3 lb | 26.7 cm dia x 26 cm | 9.5 L | 6.5 kg | 12 |
| 1834781 | RED | Round Bucket – Sanitizer | 10.5" dia x 10.25" h | 10 qt | 14.3 lb | 26.7 cm dia x 26 cm | 9.5 L | 6.5 kg | 12 |

UTILITY REFUSE AND RECYCLING

DECORATIVE REFUSE

CLEANING

MATERIAL HANDLING

WASHROOM

FOODSERVICE

ACCESSORIES & INDEX

Pail and Mop Strainer Combination

Lightweight design helps increase operator productivity.

- Lightweight combo pack lets operator travel up and down stairs easily
- Pail holds up to 15 quarts (14.2 L); strainer wrings mops up to 10 ounces
- Durable plastic construction has smooth, easy-to-clean surface
- Pails and funnel-shaped mop strainers nest and stack for convenient transport and storage between jobs



FG619400

| NO. | COLOR | DESCRIPTION | U.S. DIMENSIONS | U.S. CAPACITY | U.S. SHIP WT/CTN | METRIC DIMENSIONS | METRIC CAPACITY | METRIC SHIP WT/CTN | PACK |
|----------|-------|-----------------------------------|-------------------------|---------------|------------------|-----------------------------|-----------------|--------------------|------|
| FG619400 | STL | Pail and Mop Strainer Combination | 17" l x 10.5" w x 12" h | 15 qt | 14.9 lb | 43.2 cm x 26.7 cm x 30.5 cm | 14.2 L | 6.8 kg | 6 |
| FGG04300 | WH00 | Replacement Mop Head for FGGO4204 | N/A | 8 oz | 7 lb | N/A | 0.2 kg | 3.2 kg | 12 |
| 1809375 | N/A | Self-Wringing Twist Mop | 54" l x 54" w | N/A | 17.5 lb | 137.2 cm x 137.2 cm | N/A | 7.9 kg | 4 |

Steel Sponge Mop/Double Pails

An easy-to-use cleaning system.

- Front-pull lever on mop handle for squeeze-action wringing (FG643500)
- Cellulose sponge mop head absorbs liquids fast
- Double pail for separation of cleaning solution and rinse water



FG262888



FGG78004



FG643500

| NO. | COLOR | DESCRIPTION | U.S. DIMENSIONS | U.S. CAPACITY | U.S. SHIP WT/CTN | METRIC DIMENSIONS | METRIC CAPACITY | METRIC SHIP WT/CTN | PACK |
|----------|-------|--------------------------------------|--------------------------------|---------------|------------------|-----------------------------|-----------------|--------------------|------|
| FG261700 | GRAY | Double Pail | 14.63" l x 13.88" w x 10.13" h | 17 qt | 18.1 lb | 37.2 cm x 35.3 cm x 25.7 cm | 16.1 L | 8.2 kg | 6 |
| FG262888 | GRAY | Double Pail | 18" l x 14.5" w x 10" h | 19 qt | 21.1 lb | 45.7 cm x 36.8 cm x 25.4 cm | 18 L | 9.6 kg | 6 |
| FG643500 | BRNZ | Steel Sponge Mop with Cellulose Head | 12" l | N/A | 14.9 lb | 30.5 cm | N/A | 6.8 kg | 6 |
| FG643600 | YEL | Steel Cellulose Replacement Head | 12" l | N/A | 8.4 lb | 30.5 cm | N/A | 3.8 kg | 12 |
| FGG78004 | | PVA Sponge Mop | 11.3" l x 2.8" w x 37.6" h | N/A | 35.0 lb | 28.7 cm x 7.1 cm x 95.5 cm | N/A | 15.9 kg | 4 |
| FGG78112 | | PVA Sponge Mop Refill | 12.8" l x 4.2" w x 2.2" h | N/A | 5.2 lb | 32.5 cm x 10.7 cm x 5.6 cm | N/A | 2.4 kg | 12 |

UTILITY REFUSE AND RECYCLING

DECORATIVE REFUSE

CLEANING

MATERIAL HANDLING

WASHROOM

FOODSERVICE

ACCESSORIES & INDEX

Dust Mopping

There are several important factors to consider when choosing a dust mop. Use the guidelines on the following pages to choose the best dust mop for your floor care needs.

General Dust Mopping

Choose mops with high-dust pickup and durability. If laundering is available, launderable mops will be the most economical choice. Microfiber looped-end and twisted-loop mop heads with reinforced stitching and slip-on/slide-off backing offer the best performance and launderability.



Mop Construction Features



Twisted-Loops

Highly effective at capturing dust and dirt. Premium Twisted-Loops are less prone to snags, frays, and unraveling during cleaning and laundering.

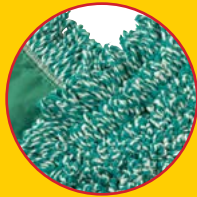

Looped Ends

Reduce fraying and depleting for better durability and longer product life. More effective than cut-end mops.



Cut Ends

Economical construction for general-purpose dusting.



Reinforced Stitching

Reinforced, double-needle stitching at key "wear" points increases product life.



Backing Design

Slip-on/slide-off backing allows quick, easy setup or breakdown for standard mop frames.

Launderability

The launderability of a mop is based on the number of commercial washing and drying cycles it can withstand before the construction of the mop is degraded or the performance declines. Microfiber, synthetic, and blended fiber mops have the highest levels of launderability.

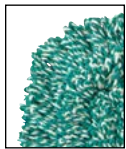

MICROFIBER



BLEND



SYNTHETIC

Durability

The durability of a mop is a measure of how long it will perform before needing to be replaced. Microfiber, synthetic, and blended fiber mops are the most durable.

Mops with **antimicrobial fibers** have greater durability because they inhibit the bacterial growth that causes mop odor and discoloration.

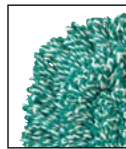

MICROFIBER



BLEND



ANTIMICROBIAL



SYNTHETIC

Dust Pickup

Dust pickup is the ability of a mop to remove dust and dirt from the floor surface. Microfiber, blended fiber, and synthetic mops have the highest degree of dust pickup.



MICROFIBER



SYNTHETIC



BLEND

Dust Mop Selection Guide

Use the following guide to choose the best Rubbermaid Commercial Products Dust Mops for your facility.

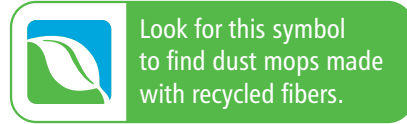

| ENVIRONMENT | BEST | BETTER | GOOD |
|---------------------------|---|------------|-------------------------------|
| HEALTHCARE FACILITIES | HYGEN™ Microfiber Dust Mops Microfiber Looped-End Dust Mop Twisted-Loop Antimicrobial | Trapper® | Kut-A-Way® |
| EDUCATIONAL FACILITIES | HYGEN™ Microfiber Dust Mops Microfiber Looped-End Dust Mop Twisted-Loop | Kut-A-Way® | Cut-to-Length |
| INDUSTRIAL AND COMMERCIAL | HYGEN™ Microfiber Dust Mops Microfiber Looped-End Dust Mop Trapper® | Kut-A-Way® | Disposable Cut-End Blended |
| FOODSERVICE | HYGEN™ Microfiber Dust Mops Microfiber Looped-End Dust Mop Twisted-Loop | Kut-A-Way® | Disposable Cut-End Blended |
| OFFICE BUILDINGS | HYGEN™ Microfiber Dust Mops Microfiber Looped-End Dust Mop Twisted-Loop | Kut-A-Way® | Disposable Cut-End Blended |
| HOSPITALITY | HYGEN™ Microfiber Dust Mops Microfiber Looped-End Dust Mop Twisted-Loop | Kut-A-Way® | Disposable Cut-End Blended |



UTILITY REFUSE
AND RECYCLING

DECORATIVE REFUSE

CLEANING

HYGEN™ Dust Mops

Capture and remove more dirt and dust.

HYGEN™ Dust Mops remove up to 80% more dust and dirt than traditional cotton dust mops. Durable up to 500 launderings (200 with bleach). Certified to tolerate CDC hot and cold water laundering requirements.

*see page 78 for more details

FGQ41800*
FGQ41200*

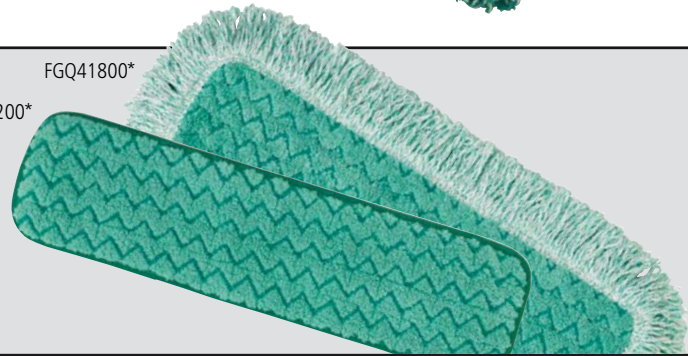

MATERIAL HANDLING

Microfiber Looped-End Dust Mops

Featuring the cleaning power of microfiber combined with famous high-quality Rubbermaid construction.

- Constructed with a blend of continuous-filament microfiber and traditional spun staple mop yarn
- Withstands twice the laundry cycles of traditional dust mops
- Works with all traditional dust mop handles and frames
- Recycled content: up to 28% post-industrial cotton and 42% PET plastic

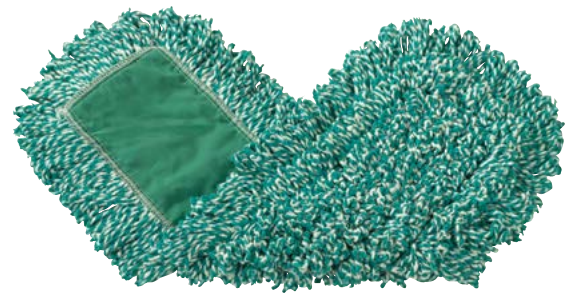

FGJ85300

WASHROOM

FOODSERVICE

| NO. | MOP COLOR | DESCRIPTION | U.S. SHIP WT/CTN | U.S. MOP SIZE | METRIC SHIP WT/CTN | METRIC MOP SIZE | PACK |
|----------|-----------|------------------------------|------------------|---------------|--------------------|--------------------|------|
| FGJ85200 | GR00 | Microfiber Loop Dust Mop 18" | 9.25 lb | 18" l x 5" w | 4.2 kg | 45.7 cm x 12.7 cm | 12 |
| FGJ85300 | GR00 | Microfiber Loop Dust Mop 24" | 11.7 lb | 24" l x 5" w | 5.3 kg | 61 cm x 12.7 cm | 12 |
| FGJ85500 | GR00 | Microfiber Loop Dust Mop 36" | 15.0 lb | 36" l x 5" w | 6.8 kg | 91.4 cm x 12.7 cm | 12 |
| FGJ85700 | GR00 | Microfiber Loop Dust Mop 48" | 18.7 lb | 48" l x 5" w | 8.5 kg | 121.9 cm x 12.7 cm | 12 |
| FGJ85800 | GR00 | Microfiber Loop Dust Mop 60" | 22.4 lb | 60" l x 5" w | 10.2 kg | 152.4 cm x 12.7 cm | 12 |
| FGJ85900 | GR00 | Microfiber Loop Dust Mop 72" | 22.4 lb | 72" l x 5" w | 10.2 kg | 182.9 cm x 12.7 cm | 12 |

ACCESSORIES
& INDEX



Twisted-Loop Dust Mops

Premium prelaundered dust mops provide maximum durability and optimal cleaning performance. Twisted loops create fuller mop heads with no gaps, offering better coverage than traditional ply yarn and improved collection and retention of dust and dirt particles.

- Blended antimicrobial mops are specially treated to help inhibit the growth of bacteria
- Less prone to snagging, fraying, and unraveling
- Slip-on backing for easy setup
- Durable polyester backing designed for launderable printing that will not launder out
- *Handles sold separately; see Dust Mop Frames and Handles*



FGK75300 WH00 / FGJ25300 BL00 /
FGJ15300 YL00 / FGJ55300 GR00 /
FGJ35300 BL00



Blended Antimicrobial

| NO. | COLOR | DESCRIPTION | U.S. SHIP WT/CTN | U.S. MOP SIZE | METRIC SHIP WT/CTN | METRIC MOP SIZE | PACK |
|----------|-------------|---|------------------|---------------|--------------------|--------------------|------|
| FGJ55300 | GR00 | Twisted-Loop Blend Antimicrobial Dust Mop | 12.4 lb | 24" l x 5" w | 5.6 kg | 61 cm x 12.7 cm | 12 |
| FGJ55500 | GR00 | Twisted-Loop Blend Antimicrobial Dust Mop | 17.7 lb | 36" l x 5" w | 8 kg | 91.4 cm x 12.7 cm | 12 |
| FGJ55700 | GR00 | Twisted-Loop Blend Antimicrobial Dust Mop | 22.4 lb | 48" l x 5" w | 10.2 kg | 121.9 cm x 12.7 cm | 12 |



Synthetic

| NO. | COLOR | DESCRIPTION | U.S. SHIP WT/CTN | U.S. MOP SIZE | METRIC SHIP WT/CTN | METRIC MOP SIZE | PACK |
|----------|-------------|---------------------------------|------------------|---------------|--------------------|--------------------|------|
| FGJ35200 | BL00 | Twisted-Loop Synthetic Dust Mop | 9.2 lb | 18" l x 5" w | 4.2 kg | 45.7 cm x 12.7 cm | 12 |
| FGJ35300 | BL00 | Twisted-Loop Synthetic Dust Mop | 12.4 lb | 24" l x 5" w | 5.6 kg | 61 cm x 12.7 cm | 12 |
| FGJ35500 | BL00 | Twisted-Loop Synthetic Dust Mop | 17.7 lb | 36" l x 5" w | 8 kg | 91.4 cm x 12.7 cm | 12 |
| FGJ35700 | BL00 | Twisted-Loop Synthetic Dust Mop | 22.4 lb | 48" l x 5" w | 10.2 kg | 121.9 cm x 12.7 cm | 12 |
| FGJ35800 | BL00 | Twisted-Loop Synthetic Dust Mop | 25.2 lb | 60" l x 5" w | 11.4 kg | 152.4 cm x 12.7 cm | 12 |



Blended

| NO. | COLOR | DESCRIPTION | U.S. SHIP WT/CTN | U.S. MOP SIZE | METRIC SHIP WT/CTN | METRIC MOP SIZE | PACK |
|----------|-------------|-----------------------------|------------------|---------------|--------------------|--------------------|------|
| FGJ25200 | BL00 | Twisted-Loop Blend Dust Mop | 9.2 lb | 18" l x 5" w | 4.2 kg | 45.7 cm x 12.7 cm | 12 |
| FGJ25300 | BL00 | Twisted-Loop Blend Dust Mop | 12.4 lb | 24" l x 5" w | 5.6 kg | 61 cm x 12.7 cm | 12 |
| FGJ25500 | BL00 | Twisted-Loop Blend Dust Mop | 17.7 lb | 36" l x 5" w | 8 kg | 91.4 cm x 12.7 cm | 12 |
| FGJ25700 | BL00 | Twisted-Loop Blend Dust Mop | 22.4 lb | 48" l x 5" w | 10.2 kg | 121.9 cm x 12.7 cm | 12 |



Cotton

| NO. | COLOR | DESCRIPTION | U.S. SHIP WT/CTN | U.S. MOP SIZE | METRIC SHIP WT/CTN | METRIC MOP SIZE | PACK |
|----------|-------------|------------------------------|------------------|---------------|--------------------|-------------------|------|
| FGK75300 | WH00 | Twisted-Loop Cotton Dust Mop | 12.4 lb | 24" l x 5" w | 5.6 kg | 61 cm x 12.7 cm | 12 |
| FGK75500 | WH00 | Twisted-Loop Cotton Dust Mop | 17.7 lb | 36" l x 5" w | 8 kg | 91.4 cm x 12.7 cm | 12 |

UTILITY REFUSE AND RECYCLING

DECORATIVE REFUSE

CLEANING

MATERIAL HANDLING

WASHROOM

FOODSERVICE

ACCESSORIES & INDEX

Trapper® Dust Mops

Looped-end, balanced-blend dust mop for general-purpose dust mopping.

- Pretreated and fully launderable for long product life
- Slip-on backing for easy setup
- All-sewn construction
- Recycled content: up to 65% post-industrial cotton and 35% PET plastic



FGJ15700

| NO. | COLOR | DESCRIPTION | U.S. SHIP WT/CTN | U.S. MOP SIZE | METRIC SHIP WT/CTN | METRIC MOP SIZE | PACK |
|-----------|-------|-------------------|------------------|---------------|--------------------|--------------------|------|
| FGJ15100 | YL00 | Trapper® Dust Mop | 8.0 lb | 12" l x 5" w | 3.6 kg | 30.5 cm x 12.7 cm | 12 |
| FGJ15200* | YL00 | Trapper® Dust Mop | 9.0 lb | 18" l x 5" w | 4.1 kg | 45.7 cm x 12.7 cm | 12 |
| FGJ15300* | YL00 | Trapper® Dust Mop | 11.0 lb | 24" l x 5" w | 5.0 kg | 61 cm x 12.7 cm | 12 |
| FGJ15500* | YL00 | Trapper® Dust Mop | 16.0 lb | 36" l x 5" w | 7.3 kg | 91.4 cm x 12.7 cm | 12 |
| FGJ15700* | YL00 | Trapper® Dust Mop | 21.0 lb | 48" l x 5" w | 9.5 kg | 121.9 cm x 12.7 cm | 12 |
| FGJ15800 | YL00 | Trapper® Dust Mop | 25.2 lb | 60" l x 5" w | 11.4 kg | 152.4 cm x 12.7 cm | 12 |

*Available in 3-pack (-03).

Kut-A-Way® Dust Mops

Cut-end mop excellent for general-purpose dust mopping.

- Prelaundered
- Launderable for long product life
- Envelope-end backing style
- All sewn construction
- Recycled content: colors are up to 65% post-industrial cotton and 35% PET plastic; white is up to 100% post-industrial cotton



FGK15700

| NO. | COLOR | DESCRIPTION | U.S. SHIP WT/CTN | U.S. MOP SIZE | METRIC SHIP WT/CTN | METRIC MOP SIZE | PACK |
|----------|------------|---------------------|------------------|---------------|--------------------|--------------------|------|
| FGK15200 | WH00, BL00 | Kut-A-Way® Dust Mop | 9.0 lb | 18" l x 5" w | 4.1 kg | 45.7 cm x 12.7 cm | 12 |
| FGK15300 | WH00, BL00 | Kut-A-Way® Dust Mop | 11.0 lb | 24" l x 5" w | 5.0 kg | 61 cm x 12.7 cm | 12 |
| FGK15500 | WH00, BL00 | Kut-A-Way® Dust Mop | 16.0 lb | 36" l x 5" w | 7.3 kg | 91.4 cm x 12.7 cm | 12 |
| FGK15700 | WH00, BL00 | Kut-A-Way® Dust Mop | 21.0 lb | 48" l x 5" w | 9.5 kg | 121.9 cm x 12.7 cm | 12 |
| FGK15800 | WH00 | Kut-A-Way® Dust Mop | 26.0 lb | 60" l x 5" w | 11.8 kg | 152.4 cm x 12.7 cm | 12 |
| FGK15900 | WH00 | Kut-A-Way® Dust Mop | 31.0 lb | 72" l x 5" w | 14.1 kg | 182.9 cm x 12.7 cm | 12 |

Disposable Cut-End Blended Dust Mops

Soft, open-twist blended cut-end yarn for increased dust pickup.

- Pretreated and mops up to 500,000 sq ft (46,450 m²) before needing replacement
- Envelope-end backing style and durable Typar® backing
- Recycled content: colors are up to 65% post-industrial cotton and 35% PET plastic



FGL15700

| NO. | COLOR | DESCRIPTION | U.S. SHIP WT/CTN | U.S. MOP SIZE | METRIC SHIP WT/CTN | METRIC MOP SIZE | PACK |
|----------|------------|-------------------------------------|------------------|---------------|--------------------|--------------------|------|
| FGL15300 | GR00, WH00 | Blended Cut-End Disposable Dust Mop | 9.0 lb | 24" l x 5" w | 4.1 kg | 61 cm x 12.7 cm | 12 |
| FGL15500 | WH00 | Blended Cut-End Disposable Dust Mop | 13.0 lb | 36" l x 5" w | 5.9 kg | 91.4 cm x 12.7 cm | 12 |
| FGL15700 | GR00, WH00 | Blended Cut-End Disposable Dust Mop | 17.0 lb | 48" l x 5" w | 7.7 kg | 121.9 cm x 12.7 cm | 12 |
| FGL15800 | WH00 | Blended Cut-End Disposable Dust Mop | 21.0 lb | 60" l x 5" w | 9.5 kg | 152.4 cm x 12.7 cm | 12 |
| FGL15900 | WH00 | Blended Cut-End Disposable Dust Mop | 25.0 lb | 72" l x 5" w | 11.3 kg | 182.9 cm x 12.7 cm | 12 |

UTILITY REFUSE AND RECYCLING

DECORATIVE REFUSE

CLEANING

MATERIAL HANDLING

WASHROOM

FOODSERVICE

ACCESSORIES & INDEX



Disposable Cut-End Cotton Dust Mops

Economical cotton cut-end dust mop.

- Pretreated, with envelope-end backing style
- Recycled content: up to 100% post-industrial cotton



FGL25500

| NO. | COLOR | DESCRIPTION | U.S. SHIP WT/CTN | U.S. MOP SIZE | METRIC SHIP WT/CTN | METRIC MOP SIZE | PACK |
|----------|-------------|------------------------------------|------------------|---------------|--------------------|--------------------|------|
| FGL25300 | WH00 | Cut-End Disposable Cotton Dust Mop | 9.0 lb | 24" l x 5" w | 4.1 kg | 61 cm x 12.7 cm | 12 |
| FGL25500 | WH00 | Cut-End Disposable Cotton Dust Mop | 13.0 lb | 36" l x 5" w | 5.9 kg | 91.4 cm x 12.7 cm | 12 |
| FGL25700 | WH00 | Cut-End Disposable Cotton Dust Mop | 17.0 lb | 48" l x 5" w | 7.7 kg | 121.9 cm x 12.7 cm | 12 |

Snap-On Wire Dust Mop Frames

Corrosion-resistant, powder-coated, heavy-duty metal frame for durable performance.



FGM25100



| NO. | COLOR | DESCRIPTION | U.S. DIMENSIONS | U.S. SHIP WT/CTN | METRIC DIMENSIONS | METRIC SHIP WT/CTN | PACK |
|----------|-------------|-----------------------------|-----------------|------------------|--------------------|--------------------|------|
| FGM25100 | 0000 | Snap-On Wire Dust Mop Frame | 12" l x 5" w | 9.0 lb | 30.5 cm x 12.7 cm | 4.1 kg | 12 |
| FGM25200 | 0000 | Snap-On Wire Dust Mop Frame | 18" l x 5" w | 12.0 lb | 45.7 cm x 12.7 cm | 5.4 kg | 12 |
| FGM25300 | 0000 | Snap-On Wire Dust Mop Frame | 24" l x 5" w | 14.0 lb | 61 cm x 12.7 cm | 6.4 kg | 12 |
| FGM25500 | 0000 | Snap-On Wire Dust Mop Frame | 36" l x 5" w | 18.0 lb | 91.4 cm x 12.7 cm | 8.2 kg | 12 |
| FGM25700 | 0000 | Snap-On Wire Dust Mop Frame | 48" l x 5" w | 22.0 lb | 121.9 cm x 12.7 cm | 10 kg | 12 |
| FGM25800 | 0000 | Snap-On Wire Dust Mop Frame | 60" l x 5" w | 27.0 lb | 152.4 cm x 12.7 cm | 12.2 kg | 12 |
| FGM25900 | 0000 | Snap-On Wire Dust Mop Frame | 72" l x 5" w | 33.0 lb | 182.9 cm x 12.7 cm | 15 kg | 12 |

Snap-On Dust Mop Handles

Available in easily sanitized, vinyl-covered wood, fiberglass, or hardwood handles.

- Spring-loaded clip easily attaches to the Snap-On Dust Mop Frame
- Sliding collar locks the handle into position or swivels a full 360°



Bamboo composite handles support sustainable mopping.



FGM11600

| NO. | COLOR | DESCRIPTION | U.S. DIMENSIONS | U.S. SHIP WT/CTN | METRIC DIMENSIONS | METRIC SHIP WT/CTN | PACK |
|----------|-------------|--|-----------------|------------------|-------------------|--------------------|------|
| FGM11600 | 0000 | Snap-On Dust Mop Handle, Hardwood | 60" l | 26.0 lb | 152.4 cm | 11.8 kg | 12 |
| FGM13600 | 0000 | Snap-On Dust Mop Handle, Vinyl-Covered, Hardwood | 60" l | 26.0 lb | 152.4 cm | 11.8 kg | 12 |
| FGM14600 | 0000 | Snap-On Dust Mop Handle, Fiberglass | 60" l | 24.0 lb | 152.4 cm | 10.9 kg | 12 |

UTILITY REFUSE AND RECYCLING

DECORATIVE REFUSE

CLEANING

MATERIAL HANDLING

WASHROOM

FOODSERVICE

ACCESSORIES & INDEX

Cut-to-Length Dust Mop

Cuts floor cleaning costs down to size.

- Continuous 40' (12.2 m) roll yields 20% savings over conventional dust mops
- Cut-to-length convenience lets you customize your mop to fit any standard mop frame
- Untreated, cut-end 4-ply cotton yarn provides excellent dust pickup; durable Typar® backing for long life
- Slip-on backing for easy setup
- Recycled content: up to 100% post-industrial cotton



FGM15000



| NO. | COLOR | DESCRIPTION | U.S. DIMENSIONS | U.S. CARTON DIMENSIONS | U.S. SHIP WT/CTN | METRIC DIMENSIONS | METRIC CARTON DIMENSIONS | METRIC SHIP WT/CTN | PACK |
|----------|-------|------------------------|-----------------|-----------------------------------|------------------|--------------------|-----------------------------|--------------------|------|
| FGM15000 | WH00 | Cut-to-Length Dust Mop | 40" l x 5" w | 18 1/2" l x 11 3/4" w x 12 3/4" h | 13.0 lb | 101.6 cm x 12.7 cm | 46.4 cm x 29.8 cm x 32.1 cm | 5.9 kg | 1 |

Wedge Mop System

For spot dust mopping in tight corners, under equipment, or behind furniture.

- Offered in Trapper® looped-end or Kut-A-Way® cut-end triangle-shaped wedge mops
- Wood handle with heavy-gauge plated wire frame fits either style head
- Envelope-end backing style
- U120 contains up to 35% PET plastic



FGU12000



FGU13000



FGU11000



| NO. | COLOR | DESCRIPTION | U.S. SHIP WT/CTN | METRIC SHIP WT/CTN | PACK |
|----------|-------|---|------------------|--------------------|------|
| FGU11000 | 0000 | Wedge Mop Handle and Frame, Wood Handle with Metal Frame | 17.0 lb | 7.7 kg | 12 |
| FGU12000 | YL00 | Trapper® Wedge Mop Dust Mop Head, Looped-End | 5.5 lb | 2.5 kg | 12 |
| FGU13000 | WH00 | Kut-A-Way® Wedge Mop Dust Mop Head, Cut-End | 5.5 lb | 2.5 kg | 12 |
| FGU13067 | WH00 | Kut-A-Way® Wedge Mop Kit, Contains FGU13000 Mop, FGU11000 Handle, and Frame | 3.0 lb | 1.4 kg | 1 |

UTILITY REFUSE AND RECYCLING

DECORATIVE REFUSE

CLEANING

MATERIAL HANDLING

WASHROOM

FOODSERVICE

ACCESSORIES & INDEX



MAXIMIZER™ Dust Mop with EZ Access Scraper

- EZ Access Scraper connects to handle for quick clean up of stuck-on debris
- Lightweight system weighs 30% less than standard RCP Dust Mop Frame & Handle
- Scraper features stainless steel blade for durability and superior wear resistance
- Quick change handle for easy tool attachment and molded grip for comfort



| NO. | COLOR | DESCRIPTION | U.S. DIMENSIONS | U.S. SHIP WT/CTN | METRIC DIMENSIONS | METRIC SHIP WT/CTN | PACK |
|---------|--------|--|---------------------------|------------------|-----------------------------|--------------------|------|
| 2018808 | Black | Maximizer™ Dust Frame, Handle, and Scraper – 24" | 57.0" l x 5.5" w x 1.8" h | 1.9 lb | 144.8 cm x 14.0 cm x 4.6 cm | 4.8 kg | 6 |
| 2018809 | Black | Maximizer™ Dust Frame, Handle, and Scraper – 36" | 57.0" l x 5.5" w x 1.8" h | 2.6 lb | 144.8 cm x 14.0 cm x 4.6 cm | 6.6 kg | 6 |
| 2018810 | Yellow | Maximizer™ Dust Mop Pad – 24" | 25.3" l x 5.5" w x 0.5" h | 1.2 lb | 64.3 cm x 14.0 cm x 1.3 cm | 3.0 kg | 12 |
| 2018821 | Yellow | Maximizer™ Dust Mop Pad – 36" | 37.3" l x 5.5" w x 0.5" h | 1.7 lb | 94.7 cm x 14.0 cm x 1.3 cm | 4.3 kg | 12 |
| 2018822 | Black | Maximizer™ EZ Access Scraper – Replacement | 6.6" l x 1.6" w x 1.6" h | 0.2 lb | 16.8 cm x 4.1 cm x 4.1 cm | 0.5 kg | 12 |

MAXIMIZER™ Overhead Cleaning Tool

- Cleans hard to reach spaces with less effort
- Multi-directional rotating head delivers better leverage when cleaning overhead surfaces
- Push button adjusts head to three different positions and locks in place for controlled cleaning in hard to reach areas
- Extends to 10' for maximum access to high surfaces
- Frame accepts 11" HYGEN™ Wall/Stair and 11" HYGEN™ Pads (sold separately)



2018825



2018824



| NO. | COLOR | DESCRIPTION | U.S. DIMENSIONS | U.S. SHIP WT/CTN | METRIC DIMENSIONS | METRIC SHIP WT/CTN | PACK |
|---------|-------|-----------------------------------|---------------------------|------------------|-----------------------------|--------------------|------|
| 2018824 | Black | Maximizer™ Overhead Cleaning Tool | 71.5" l x 3.5" w x 2.4" h | 2.5 lb | 181.6 cm x 8.9 cm x 6.1 cm | 1.1 kg | 6 |
| 2018825 | Blue | 11" HYGEN™ Microfiber Window Pad | 12.6" l x 5.6" w x 0.2" h | 0.1 lb | 32.0 cm x 14.22 cm x 0.5 cm | 0.04 kg | 6 |

When ordering products with **BOLD** color codes, please specify color code after the product number. Refer to the Standard Color Guide at the back of the catalog.

UTILITY REFUSE AND RECYCLING

DECORATIVE REFUSE

CLEANING

MATERIAL HANDLING

WASHROOM

FOODSERVICE

ACCESSORIES & INDEX

Overhead Dusting Tools

A sensible solution to routine overhead dusting.

- Heads are launderable for long product life
- Telescoping handle allows simple and efficient overhead use
- The FGT13000 extends up to 102" (8½ feet/2.6 m) to reach high areas



FGT12000

Flexible-Head Overhead Dusting Tools

Flexible head adjusts to match surface.

- Flexible head conforms to virtually any shape for more efficient cleaning
- Launderable Dust Mitt can be worn on the hand or used with the Flexible Head Dusting Tool
- FGQ65200 Microfiber Dusting Mitt fits FGT41000 Dusting Tool



FGT41000

Lambswool Duster

Fast, effective surface dusting.

- 100% lambswool duster
- Ideal for dusting large areas quickly and effectively



FG9C0400

| NO. | COLOR | DESCRIPTION | U.S. SHIP WT/CTN | METRIC SHIP WT/CTN | PACK |
|----------|-------|--|------------------|--------------------|------|
| FGT11000 | GY00 | Overhead Dusting Tool with Launderable Head, 51" I (129.5 cm) Extension Handle | 8.0 lb | 3.6 kg | 12 |
| FGT12000 | GY00 | Overhead Dusting Tool with Angled Launderable Head, 51" I (129.5 cm) Extension Handle | 8.0 lb | 3.6 kg | 12 |
| FGT13000 | GY00 | Overhead Dusting Tool with Launderable Head, 8½' I (2.6 m) Extension Handle | 17.0 lb | 7.7 kg | 12 |
| FGT19900 | WH00 | Overhead Dusting Tool Replacement Head fits FGT11000, FGT12000, FGT13000 | 4.0 lb | 1.8 kg | 12 |
| FGT41000 | 0000 | Flexible-Head Overhead Dusting Tool, Flexible Head with 60" I (152.4 cm) Aluminum Handle | 8.0 lb | 3.6 kg | 6 |
| FG9C0400 | 0000 | 30"-42" (76.2 cm-106.6 cm) Lambswool Duster with Telescoping Plastic Handle | 1.8 lb | 0.8 kg | 6 |

Carpet Bonnets

Use with a standard rotary floor machine for interim carpet maintenance.

- Standard thickness, original blend bonnets work well with either shampoo or solvent-based chemicals; use with a 175 RPM floor machine
- The low-profile bonnet provides improved operator control on rotary floor machines from 175 to 300 RPM



FGP26700



FGQ25700



FGQ11700

| NO. | COLOR | DESCRIPTION | U.S. DIMENSIONS | U.S. SHIP WT/CTN | METRIC DIMENSIONS | METRIC SHIP WT/CTN | PACK |
|----------|-------|--|-----------------|------------------|-------------------|--------------------|------|
| FGQ25700 | WH00 | 17" Microfiber Carpet Bonnet | 17" dia | 8.0 lb | 43.2 cm dia | 3.6 kg | 5 |
| FGQ25900 | WH00 | 19" Microfiber Carpet Bonnet | 19" dia | 9.0 lb | 48.3 cm dia | 4.1 kg | 5 |
| FGP11700 | WH00 | Standard Thickness Bonnet | 17" dia | 8.0 lb | 43.2 cm dia | 3.6 kg | 5 |
| FGP11900 | WH00 | Standard Thickness Bonnet | 19" dia | 9.0 lb | 48.3 cm dia | 4.1 kg | 5 |
| FGP12100 | WH00 | Standard Thickness Bonnet | 21" dia | 10.0 lb | 53.3 cm dia | 4.5 kg | 5 |
| FGP26700 | WH00 | Low-Profile with Green Scrub Strips Bonnet | 17" dia | 8.0 lb | 43.2 cm dia | 3.6 kg | 5 |
| FGP26900 | WH00 | Low-Profile with Green Scrub Strips Bonnet | 19" dia | 9.0 lb | 48.3 cm dia | 4.1 kg | 5 |
| FGP27100 | WH00 | Low-Profile with Green Scrub Strips Bonnet | 21" dia | 10.0 lb | 53.3 cm dia | 4.5 kg | 5 |



BROOM CONSTRUCTION

Using a state of the art production process in Lumberton, NC, RCP push brooms feature advanced injection molding, computer-optimized bristle stapling and full-scale push broom assembly to ensure consistent, durable, high quality brooms that stand up to the most demanding commercial jobs.



FINE BRISTLES (SMOOTH SURFACE)



POLYETHYLENE (PET)

Soft, durable material used to sweep fine debris on smooth surfaces.



TAMPICO

Soft, durable fiber with high resistance to heat and chemicals, used to sweep fine debris on wet or dry smooth surfaces.



HORSEHAIR

Premium ultra-smooth natural fiber used to sweep fine debris on smooth surfaces.

MEDIUM BRISTLES (MULTI-SURFACE)



MEDIUM POLYPROPYLENE

Medium-weight, durable fiber made to sweep debris on medium to rough surfaces.



MULTI-SURFACE

Medium-weight stiff inner polypropylene fibers and soft outer polyethylene fibers designed to sweep debris on indoor or outdoor surfaces.

HEAVY DUTY BRISTLES (ROUGH SURFACE)



PALMYRA

Rugged, natural fiber for medium to heavy debris on rough surfaces.



HEAVY DUTY POLYPROPYLENE

Premium heavy duty fiber made to sweep heavy debris and resistant to harsh environments and surfaces.

UTILITY REFUSE AND RECYCLING

DECORATIVE REFUSE

CLEANING

MATERIAL HANDLING

WASHROOM

FOODSERVICE

ACCESSORIES & INDEX

Anti-Twist Threaded Push Brooms

- Up to 40% more bristles* to remove more debris in every sweep
- Patented, anti-twist support bracket prevents handle from loosening for fewer job interruptions
- Broom bristles are staple set in a heavy duty resin block that won't warp, rot, or crack under normal usage
- Choose from Fine Polyethylene (PET), Fine Tampico, Fine Horsehair, Multi-Surface, Heavy Duty Polypropylene, and Heavy Duty Palmyra bristles
- Handles and heads sold together



| NO. | THREAD COLOR | DESCRIPTION | BRISTLE TYPE | BRISTLE U.S. SIZES | HANDLE | BLOCK | BRACE | U.S. SHIP WT/CTN | METRIC SIZES | METRIC SHIP WT/CTN | PACK |
|---------|--------------|-------------------------------|------------------|--------------------|-------------------|-------|------------|------------------|--------------|--------------------|------|
| 2040053 | | 18" Fine Pet | Fine Pet | 3" | 15/16" Wood | Resin | Anti-Twist | | 7.62 cm | | 4 |
| 2039998 | | 24" Fine Pet | Fine Pet | 3" | 15/16" Wood | Resin | Anti-Twist | | 7.62 cm | | 4 |
| 2040000 | | 24" Fine Tampico | Fine Tampico | 3" | 15/16" Wood | Resin | Anti-Twist | | 7.62 cm | | 4 |
| 2039999 | | 24" Fine Horsehair | Fine Horsehair | 3" | 15/16" Wood | Resin | Anti-Twist | | 7.62 cm | | 4 |
| 2040055 | | 18" Multi-Surface | Multi-Surface | 3" | 15/16" Wood | Resin | Anti-Twist | | 7.62 cm | | 4 |
| 2040045 | | 24" Multi-Surface | Multi-Surface | 3" | 15/16" Wood | Resin | Anti-Twist | | 7.62 cm | | 4 |
| 2040046 | | 24" Multi-Surface With Fg Hdl | Multi-Surface | 3" | 15/16" Fiberglass | Resin | Anti-Twist | | 7.62 cm | | 4 |
| 2040054 | | 18" Heavy Duty Polypropylene | Heavy Duty Pp | 4" | 15/16" Wood | Resin | Anti-Twist | | 10.16 cm | | 4 |
| 2040041 | | 24" Heavy Duty Palmyra | Hvy Duty Palmyra | 4" | 15/16" Wood | Resin | Anti-Twist | | 10.16 cm | | 4 |
| 2040050 | | 24" Heavy Duty Polypropylene | Heavy Duty Pp | 4" | 15/16" Wood | Resin | Anti-Twist | | 10.16 cm | | 4 |

Assembled Push Brooms

- Up to 40% more bristles* for efficient debris removal
- Fully assembled, permanent steel brace and die-cast aluminum connector for durability
- Choose from Fine Polyethylene (PET), Multi-Surface, Medium Polypropylene, and Heavy Duty Polypropylene bristles
- Handles and heads sold together



| NO. | THREAD COLOR | DESCRIPTION | BRISTLE TYPE | BRISTLE U.S. SIZES | HANDLE | BLOCK | BRACE | U.S. SHIP WT/CTN | METRIC SIZES | METRIC SHIP WT/CTN | PACK |
|---------|--------------|---|---------------|--------------------|-------------------|-------|-------|------------------|--------------|--------------------|------|
| 2040052 | | 24" Fine Pet Assembled | Fine Pet | 3" | 1 1/8" Wood | Wood | Steel | | 7.62 cm | | 4 |
| 2040049 | | 36" Fine Polypropylene | Fine Pet | 3" | 1 1/8" Wood | Wood | Steel | | 7.62 cm | | 4 |
| 2040048 | | 24" Multi-Surface With Squeegee | Multi-Surface | 3" | 15/16" Wood | Resin | Steel | | 7.62 cm | | 4 |
| 2040047 | | 24" Medium Polypropylene Assembled | Medium Pp | 3" | 1 1/8" Wood | Wood | Steel | | 7.62 cm | | 4 |
| 2040042 | | 24" Multi-Surface Assembled With Fg Hdl | Multi-Surface | 3" | 1 1/4" Fiberglass | Resin | Steel | | 7.62 cm | | 4 |
| 2040044 | | 36" Medium Polypropylene Assembled | Medium Pp | 3" | 1 1/8" Wood | Wood | Steel | | 7.62 cm | | 4 |
| 2040043 | | 24" Heavy Duty Polypropylene Assembled | Heavy Duty Pp | 4" | 1 1/8" Wood | Wood | Steel | | 10.16 cm | | 4 |
| 2040051 | | 36" Heavy Duty Polypropylene Assembled | Heavy Duty Pp | 4" | 1 1/8" Wood | Wood | Steel | | 10.16 cm | | 4 |

MAXIMIZER™ Push-to-Center Brooms

- Angled sides capture more debris per stroke*
- Durable polypropylene bristles can be used on smooth and rough surfaces, effectively sweeping different debris types
- PVC bristles remove fine dirt and debris on smooth, polished surfaces
- Polypropylene foam block resists cracking, splitting, warping and rotting

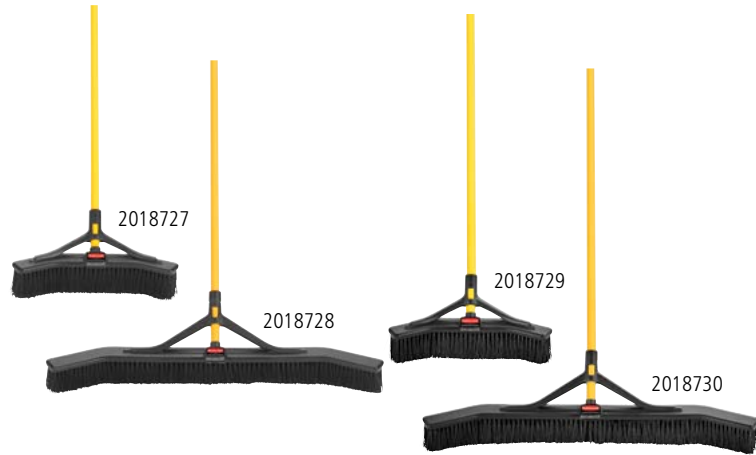

| NO. | COLOR | DESCRIPTION | U.S. DIMENSIONS | U.S. SHIP WT/CTN | METRIC DIMENSIONS | METRIC SHIP WT/CTN | PACK |
|---------|-------|--|---------------------------|------------------|------------------------------|--------------------|------|
| 2018727 | BLACK | Maximizer™ Push-To-Center Broom – 18" MP | 58.1" l x 8.3" w x 7.8" h | 2.50 lb | 147.6 cm x 21.1 cm x 19.8 cm | 1.13 kg | 6 |
| 2018728 | BLACK | Maximizer™ Push-To-Center Broom – 36" MP | 58.1" l x 8.3" w x 8.8" h | 3.30 lb | 147.6 cm x 21.1 cm x 22.4 cm | 1.50 kg | 6 |
| 2018729 | GRAY | Maximizer™ Push-To-Center Broom – 18" Fine | 58.1" l x 8.3" w x 7.8" h | 2.50 lb | 147.6 cm x 21.1 cm x 19.8 cm | 1.13 kg | 6 |
| 2018730 | GRAY | Maximizer™ Push-To-Center Broom – 36" Fine | 58.1" l x 8.3" w x 8.8" h | 3.30 lb | 147.6 cm x 21.1 cm x 22.4 cm | 1.50 kg | 6 |

*(vs. standard RCP push brooms)

Street Sweep

For the most demanding rough surfaces.

- Wide flared ends for greater floor coverage and ease when sweeping close to walls or curbs
- Polypropylene bristles are washable for long life
- Accepts tapered handles
- *Handles sold separately*; see below



| NO. | BRISTLE COLOR | DESCRIPTION | TRIM LENGTH | U.S. DIMENSIONS | U.S. SHIP WT/CTN | METRIC DIMENSIONS | METRIC SHIP WT/CTN | PACK |
|----------|---------------|--|-------------|-----------------|------------------|-------------------|--------------------|------|
| FG982200 | BRN | Plastic Foam Block, Medium Floor Sweep, Tampico Fill | 6" | 16" l | 12.4 lb | 40.6 cm | 5.6 kg | 4 |

Broom Handles

Available in threaded or tapered tips.

- Available in wood or lightweight aluminum

FG635200 / FG636200



FG635100 / FG636100



FG635500



FG635700



FG636400



Threaded

| NO. | COLOR | DESCRIPTION | U.S. DIMENSIONS | U.S. SHIP WT/CTN | METRIC DIMENSIONS | METRIC SHIP WT/CTN | PACK |
|----------|-------|--|-------------------|------------------|-----------------------|--------------------|------|
| FG635100 | LAC | Wood Handle, Threaded, Lacquered | 1.06" dia x 54" l | 11.0 lb | 2.7 cm dia x 137.2 cm | 5 kg | 12 |
| FG635500 | GRAY | Aluminum Handle, Threaded Plastic Tip, Vinyl Grip | 1" dia x 57" l | 10.3 lb | 2.5 cm dia x 144.8 cm | 4.7 kg | 12 |
| FG635700 | BLA | Super Self-Locking Wood Handle, Threaded Metal Tip | 1.06" dia x 60" l | 13.7 lb | 2.7 cm dia x 152.4 cm | 6.2 kg | 12 |
| FG636100 | LAC | Wood Handle, Threaded, Lacquered | 1.06" dia x 60" l | 13.4 lb | 2.7 cm dia x 152.4 cm | 6.1 kg | 12 |
| FG636400 | LAC | Wood Handle, Threaded Metal Tip, Lacquered | 1.06" dia x 60" l | 13.0 lb | 2.7 cm dia x 152.4 cm | 5.9 kg | 12 |

Tapered

| NO. | COLOR | DESCRIPTION | U.S. DIMENSIONS | U.S. SHIP WT/CTN | METRIC DIMENSIONS | METRIC SHIP WT/CTN | PACK |
|----------|-------|------------------------------|-------------------|------------------|-----------------------|--------------------|------|
| FG635200 | NAT | Wood Handle, Tapered, Sanded | 1.13" dia x 54" l | 16.2 lb | 2.9 cm dia x 137.2 cm | 7.3 kg | 12 |
| FG636200 | NAT | Wood Handle, Tapered, Sanded | 1.13" dia x 60" l | 16.1 lb | 2.9 cm dia x 152.4 cm | 7.3 kg | 12 |

When ordering products with **BOLD** color codes, please specify color code after the product number. Refer to the Standard Color Guide at the back of the catalog.

UTILITY REFUSE AND RECYCLING

DECORATIVE REFUSE

CLEANING

MATERIAL HANDLING

WASHROOM

FOODSERVICE

ACCESSORIES & INDEX

Angle Brooms

Ideal for cleaning hard-to-reach areas.

- Cut and shaped for easy sweeping
- Long-lasting, stain-resistant polypropylene bristles
- Permanent fusion-set bristles won't pull out
- Available permanent fusion-set bristles won't pull out (only for FG639700GRAY)



| NO. | COLOR | DESCRIPTION | SWEEP FACE | U.S. SHIP WT/CTN | METRIC SHIP WT/CTN | PACK |
|----------|-------|---|------------|------------------|--------------------|------|
| FG637500 | GRAY | Broom, 1" dia (2.5 cm) Vinyl-Coated Metal Handle, Flagged Polypropylene Fill | 10.5" | 10.2 lb | 4.6 kg | 6 |
| 1861076 | BLACK | Executive Angle Broom w/ Vinyl Handle | 10.5" | 10.2 lb | 4.6 kg | 6 |
| FG638500 | GRAY | Broom, 1" dia (2.5 cm) Metal Handle, Flagged Polypropylene Fill | 10.5" | 9.6 lb | 4.4 kg | 6 |
| 1861078 | BLACK | Executive Angle Broom w/ Aluminum Handle | 10.5" | 9.6 lb | 4.4 kg | 6 |
| FG638906 | BLA | Jumbo Smooth Sweep Angle Broom, 1 1/8" dia (4.76 cm) Black Metal Handle, Polypropylene Fill | 10" | 26.5 lb | 12 kg | 6 |
| FG639700 | GRAY | Broom Replacement Head, Thread fits FG635100, FG635500 Handles | 10.5" | 12 lb | 5.4 kg | 12 |

Corn Brooms

Designed for rugged indoor/outdoor cleaning.

- 100% natural broom corn fibers for long life and effective pickup
- Remove fine dirt from even or rough surfaces
- Hand-selected, heavy-duty lacquered pine handles



| NO. | THREAD COLOR | DESCRIPTION | SWEEP FACE | U.S. SIZES | U.S. SHIP WT/CTN | METRIC SIZES | METRIC SHIP WT/CTN | PACK |
|----------|--------------|--|------------|------------|------------------|--------------|--------------------|------|
| FG638300 | BLUE | Corn Broom, Warehouse, 1.13" dia (2.9 cm) Stained/Lacquered Handle | 12" | 31 lb | 30.0 lb | 14.1 kg | 13.6 kg | 12 |
| FG638400 | ORAN | Corn Broom, Warehouse, 1.13" dia (2.9 cm) Stained/Lacquered Handle | 12" | 35.5 lb | 35.5 lb | 15.9 kg | 16.1 kg | 12 |

Lobby Pro® Upright Dust Pans

Stylish pan design.

- Durable rear wheels improve wear resistance and extend product life
- Self-opening and closing lid (on FG253200 and FG253300) conceals unsightly dirt and debris
- Adjustable handle grip enhances user comfort (standard on FG253300)
- Bracket and brooms sold separately



| NO. | COLOR | DESCRIPTION | U.S. DIMENSIONS | U.S. SHIP WT/CTN | METRIC DIMENSIONS | METRIC SHIP WT/CTN | PACK |
|----------|-------|--|--------------------------|------------------|-----------------------------|--------------------|------|
| FG253100 | BLA | Executive Lobby Pro® Dust Pan, Long Handle | 12.8" l x 11.3" w x 5" h | 13.0 lb | 32.5 cm x 28.7 cm x 12.7 cm | 5.9 kg | 6 |
| FG253200 | BLA | Executive Lobby Pro® Dust Pan with Cover, Long Handle | 12.8" l x 11.3" w x 5" h | 13.0 lb | 32.5 cm x 28.7 cm x 12.7 cm | 5.9 kg | 6 |
| FG253300 | BLA | Lobby Pro® Deluxe Upright Dust Pan with Cover and Adjustable Handle Grip | 12.8" l x 11.3" w x 5" h | 16.3 lb | 32.5 cm x 28.7 cm x 12.7 cm | 7.4 kg | 6 |
| FG253400 | BLA | Lobby Pro® Upright Dust Pan Adjustable Handle Grip | 11.5" l x 6" w x 1.75" h | 2.4 lb | 29.2 cm x 15.2 cm x 4.4 cm | 1.1 kg | 6 |
| FG253500 | BLA | Lobby Pro® Upright Dust Pan Hanger Bracket | 4" l x 1.25" w x 1.25" h | 0.6 lb | 10.2 cm x 3.2 cm x 3.2 cm | 0.3 kg | 6 |
| FG253600 | BLA | Executive Lobby Broom w/ Wood Handle | 7" l x 37.5" h | 2.0 lb | 17.8 cm x 95.3 cm | 0.9 kg | 12 |
| FG637300 | BRN | Lobby Broom, 100% Corn Fill | 8" l x 1.5" w x 38" h | 10.0 lb | 20.3 cm x 3.8 cm x 96.5 cm | 4.5 kg | 12 |
| FG637400 | BLA | Executive Lobby Broom w/ Vinyl Handle | 7.5" l x 2" w x 35" h | 6.6 lb | 19.1 cm x 5.1 cm x 88.9 cm | 3 kg | 6 |



BRUSH CONSTRUCTION GUIDE

FILL—NATURAL



PALMYRA

Medium to highly stiff fiber from the Palmyra Palm provides durability and good bristle recovery. Can be used wet or dry.

FILL—SYNTHETIC



NYLON

Very durable with excellent abrasion resistance, shear/break strength, and bristle bend recovery. Will not stain, discolor, or absorb odors. Can be used wet or dry and resistant to alkalis and most solvents.



POLYSTYRENE

Extremely durable. Excellent bristle bend recovery and shear/break strength. Resistant to water, oils, and solvents. Not for sweeping compounds or oily surfaces.



POLYPROPYLENE

Very durable with good abrasion resistance and shear/break strength. Will not stain, discolor, or absorb odors. Resistant to solvents, acids, oils, fungus, and bacteria growth. Can be used wet or dry.

FILL—WIRE/METAL



BRASS

Provides a high degree of abrasion without severely scratching hard surfaces. Will not rust. Best for heavy cleaning of metal or brick surfaces that cannot sustain heavy scratches.



TEMPERED STEEL

Provides a high degree of abrasion and wear resistance. Good bend recovery. Best for aggressively removing residue from metal parts or brick work.

Plastic-Handle Utility Brushes

Long or short handles, synthetic and natural brushes.

- All-plastic structural foam blocks have hang-up hole for easy storage
- Available in both synthetic and natural Tampico bristles
- Ideal for foodservice applications and institutional use
- Choice of 8" or 20" length



FG9B3200

FG9B2900

| NO. | BRISTLE COLOR | DESCRIPTION | TRIM LENGTH | U.S. DIMENSIONS | U.S. SHIP WT/CTN | METRIC DIMENSIONS | METRIC SHIP WT/CTN | PACK |
|----------|---------------|--|-------------|-----------------|------------------|-------------------|--------------------|------|
| FG9B2900 | YEL | Short Plastic-Handle Utility Brush, Synthetic Fill | 2" | 8" l | 3.3 lb | 20.3 cm | 1.5 kg | 6 |
| FG9B3200 | YEL | Long Plastic-Handle Utility Brush, Synthetic Fill | 2" | 20" l | 6.0 lb | 50.8 cm | 2.7 kg | 6 |

When ordering products with **BOLD** color codes, please specify color code after the product number. Refer to the Standard Color Guide at the back of the catalog.

UTILITY REFUSE AND RECYCLING

DECORATIVE REFUSE

CLEANING

MATERIAL HANDLING

WASHROOM

FOODSERVICE

ACCESSORIES & INDEX

Truck and Wash Brush and Floor/Deck Scrub

Plastic blocks resist splitting and delaminating.

- Flagged synthetic fibers help avoid scratching
- Long-lasting, stain-resistant polypropylene bristles
- Extension poles and acme-thread Quick-Connect Adapter available (see page 81)
- *Handles sold separately*



FGQ70100 QUICK-CONNECT ADAPTER

Use HYGEN™ Quick-Connect handles and extension poles with any standard threaded tool.



FG633700



FG9B3400



FG9B3600



FG9B7200 / FG9B3700



| NO. | BRISTLE COLOR | DESCRIPTION | ACCEPTED HANDLE | TRIM LENGTH | U.S. DIMENSIONS | U.S. SHIP WT/CTN | METRIC DIMENSIONS | METRIC SHIP WT/CTN | PACK |
|----------|---------------|--|---------------------|-------------|-----------------|------------------|-------------------|--------------------|------|
| FG633700 | BLUE | Floor Scrub, Plastic Block, Bi-level, Polypropylene Fill | Threaded | 2" | 10" l | 7.5 lb | 25.4 cm | 3.4 kg | 6 |
| FG9B3400 | BRN | Deck Brush, Plastic Block, Palmyra Fill | Threaded | 2" | 10" l | 4.2 lb | 25.4 cm | 1.9 kg | 6 |
| FG9B3600 | YEL | Deck Brush, Plastic Block, Polypropylene Fill | Threaded | 1" | 9" l | 3.0 lb | 22.9 cm | 1.4 kg | 6 |
| FG9B3700 | GRAY | Wash Brush, Plastic Block, Flagged Polystyrene Fill | Threaded or Tapered | 2.5" | 10" l | 4.5 lb | 25.4 cm | 2 kg | 6 |
| FG9B7200 | GRN | Wash Brush, Plastic Block, Nylon Fill | Threaded or Tapered | 2.56" | 10" l | 4.5 lb | 25.4 cm | 2 kg | 6 |

Wire Brushes

Designed for tough use in difficult areas.

- For efficient removal of rust, paint, and grease
- Wire or steel bristles tackle tough cleaning jobs
- Includes convenient hole for hanging



FG9B4400



FG9B5700

| NO. | BRISTLE COLOR | DESCRIPTION | BRISTLE PATTERN | WIRE TYPE | U.S. DIMENSIONS | U.S. SHIP WT/CTN | METRIC DIMENSIONS | METRIC SHIP WT/CTN | PACK |
|----------|---------------|--|-----------------|-----------|-----------------|------------------|-------------------|--------------------|------|
| FG9B4400 | GRAY | Wire Brush with Scraper, Long Plastic Handle | 3 x 19 | Steel | 14" l | 5.3 lb | 35.6 cm | 2.4 kg | 12 |
| FG9B5700 | 0000 | Tile and Grout Brush, Brass Bristles | 2 x 9 | Brass | 8.5" l | 1.2 lb | 21.6 cm | 0.5 kg | 12 |

Scrub Brushes

Natural and synthetic fibers set in plastic block.

- Designed to make scrubbing tile and grout lines and cleaning floors, baseboards, walls, and countertops easier



FG9B5600



FG648200

| NO. | COLOR | DESCRIPTION | TRIM LENGTH | U.S. DIMENSIONS | U.S. SHIP WT/CTN | METRIC DIMENSIONS | METRIC SHIP WT/CTN | PACK |
|----------|-------|---|-------------|-----------------|------------------|-------------------|--------------------|------|
| FG648200 | COBLT | Iron Handle Scrub Brush, Polypropylene Fill | 1" | 6" l | 3.4 lb | 15.2 cm | 1.5 kg | 12 |
| FG9B5600 | BLA | Tile and Grout Brush, Plastic Bristles | .75" | 8.5" l | 0.8 lb | 21.6 cm | 0.4 kg | 12 |

UTILITY REFUSE AND RECYCLING

DECORATIVE REFUSE

CLEANING

MATERIAL HANDLING

WASHROOM

FOODSERVICE

ACCESSORIES & INDEX

Toilet Bowl Brushes and Holders

Available in several handle lengths, head sizes and styles.

- Polypropylene and crimped polypropylene fills
- Stain- and odor-resistant



| NO. | COLOR | DESCRIPTION | TRIM LENGTH | U.S. DIMENSIONS | U.S. SHIP WT/CTN | METRIC DIMENSIONS | METRIC SHIP WT/CTN | PACK |
|----------|------------|---|-------------|-----------------|------------------|-------------------|--------------------|------|
| FG631000 | WHT | Toilet Bowl Brush, Plastic Handle, Polypropylene Fill | 1.13" | 14.5" l | 7.0 lb | 36.8 cm | 3.2 kg | 24 |
| FG631100 | WHT | Toilet Bowl Brush Holder, fits FG631000 Brush | | 5" l | 6.5 lb | 12.7 cm | 2.9 kg | 24 |
| FG632000 | BRN | Toilet Bowl Brush, Plastic Handle, Polypropylene Fill | 1.5" | 17" l | 6.0 lb | 43.2 cm | 2.7 kg | 12 |

Wall Washer Kit

Pivoting head for smooth, even control.

- Raised-ribbed design works with either side-press or down-press mop wringers without requiring additional adapters
- Washable pads remove easily for laundering



FGS22600

| NO. | COLOR | DESCRIPTION | U.S. DIMENSIONS | U.S. SHIP WT/CTN | METRIC DIMENSIONS | METRIC SHIP WT/CTN | PACK |
|----------|-------------|---|-----------------|------------------|-------------------|--------------------|------|
| FGS21600 | GY00 | Wall Washer Kit Includes 1 Wood Handle, 1 Plastic Head, 2 Cotton Pads | 60" l | 2.0 lb | 152.4 cm | 0.9 kg | 1 |
| FGS22600 | GY00 | Wall Washer Kit Includes 1 Aluminum Handle, 1 Plastic Head, 2 Cotton Pads | 60" l | 2.0 lb | 152.4 cm | 0.9 kg | 1 |
| FGS29900 | WH00 | Wall Washer Replacement Pads, Launderable Cotton | 9" l x 5" w | 8.0 lb | 22.9 cm x 12.7 cm | 3.6 kg | 12 |

Counter Brushes/Whisk Broom/Heavy-Duty Dust Pans

Perfect for quick cleanups.

- Counter brushes feature structural foam blocks with tampico or polypropylene fills
- Heavy-duty plastic dust pans come in extra-large sizes to hold ample amounts of dirt and debris



FG9B5900 FG9B6000



FG200500



FG9B5500



FG634100

FG634200

| NO. | COLOR | DESCRIPTION | SWEEP FACE | U.S. DIMENSIONS | U.S. SHIP WT/CTN | METRIC DIMENSIONS | METRIC SHIP WT/CTN | PACK |
|----------|-------------|--|------------|----------------------------|------------------|-----------------------------|--------------------|------|
| FG634100 | BLA | Plastic Block Counter Brush, Tampico Fill with 8" (20.3 cm) Bristle Coverage | 8" | 12.5" l | 3.1 lb | 31.8 cm | 1.4 kg | 6 |
| FG634200 | SILV | Plastic Block Counter Brush, Flagged Polypropylene Fill with 8" (20.3 cm) Bristle Coverage | 8" | 12.5" l | 3.0 lb | 31.8 cm | 1.4 kg | 6 |
| FG9B5500 | YEL | Corn Whisk Broom | N/A | 12.25" l | 5.0 lb | 31.1 cm | 2.3 kg | 12 |
| FG200500 | CHAR | Heavy-Duty Dust Pan | N/A | 12.25" l x 8.25" w | 6.2 lb | 31.1 cm x 21 cm | 2.8 kg | 12 |
| FG9B5900 | BLA | Extra-Large Dust Pan | N/A | 16" l x 14.75" w x 5.38" h | 5.3 lb | 40.6 cm x 37.5 cm x 13.7 cm | 2.4 kg | 6 |
| FG9B6000 | BLA | Jumbo Dust Pan | N/A | 22" l x 18" w x 7.75" h | 8.7 lb | 55.9 cm x 45.7 cm x 19.7 cm | 3.9 kg | 6 |

UTILITY REFUSE AND RECYCLING

DECORATIVE REFUSE

CLEANING

MATERIAL HANDLING

WASHROOM

FOODSERVICE

ACCESSORIES & INDEX

Floor Squeegees

Dual Moss Squeegees

- Nonmarking, flexible blades are ideal for uneven surfaces
- Leaves floors virtually dry to the touch, ideal for spills
- For use in removing liquids and light dirt
- *Handles sold separately*

Traditional Squeegees

- Galvanized metal frame and locking strip
- Fit standard 1 1/8" tapered handles
- Nonmarking 2" black rubber blades
- For removing liquids and heavy dirt
- *Handles sold separately*

Professional Plastic Squeegees

- Rugged, corrosion-resistant polypropylene
- Twin black rubber blades
- For removing liquids, moderate dirt, and quick drying
- Scrub and Dry Squeegee with bristles for extra aggressive scrubbing
- Neoprene has excellent resistance to oils, grease, and most chemicals
- *Handles sold separately*



FG9C2600



FG9C2900



FG9C3100



FG9C3400



FG9C4100

Dual Moss Squeegees

| NO. | COLOR | DESCRIPTION | U.S. DIMENSIONS | U.S. SHIP WT/CTN | METRIC DIMENSIONS | METRIC SHIP WT/CTN | PACK |
|-----------|-------|---|--------------------------|------------------|----------------------------|--------------------|------|
| FG9C2600* | BLA | 18" (45.7 cm) Standard Floor Squeegee | 18" l x 3" w x 4.5" h | 5.5 lb | 45.7 cm x 7.6 cm x 11.4 cm | 2.5 kg | 10 |
| FG9C2700* | BLA | 22" (55.9 cm) Standard Floor Squeegee | 22" l x 3" w x 4.5" h | 6.6 lb | 55.9 cm x 7.6 cm x 11.4 cm | 3 kg | 10 |
| FG9C2800* | BLA | 22" (55.9 cm) Heavy-Duty Floor Squeegee | 22" l x 3.25" w x 5.5" h | 13.6 lb | 55.9 cm x 8.3 cm x 14 cm | 6.2 kg | 10 |
| FG9C2900* | BLA | 30" (76.2 cm) Heavy-Duty Floor Squeegee | 30" l x 3.25" w x 5.5" h | 15.8 lb | 76.2 cm x 8.3 cm x 14 cm | 7.2 kg | 10 |

*Use with tapered or wood handles; see page 128.

Traditional Squeegees

| NO. | COLOR | DESCRIPTION | U.S. DIMENSIONS | U.S. SHIP WT/CTN | METRIC DIMENSIONS | METRIC SHIP WT/CTN | PACK |
|-----------|-------|--|-------------------------|------------------|-----------------------------|--------------------|------|
| FG9C3100* | BLA | 18" (45.7 cm) Straight Floor Squeegee | 18" l x 4" w x 6.8" h | 11.1 lb | 45.7 cm x 10.2 cm x 17.3 cm | 5 kg | 6 |
| FG9C3200* | BLA | 24" (61 cm) Straight Floor Squeegee | 24" l x 4" w x 6.8" h | 13.7 lb | 61 cm x 10.2 cm x 17.3 cm | 6.2 kg | 6 |
| FG9C3300* | BLA | 36" (91.4 cm) Straight Floor Squeegee | 36" l x 4" w x 6.8" h | 19.8 lb | 91.4 cm x 10.2 cm x 17.3 cm | 9 kg | 6 |
| FG9C3400* | BLA | 24" (61 cm) Curved Floor Squeegee | 23.5" l x 4" w x 6.8" h | 13.7 lb | 59.7 cm x 10.2 cm x 17.3 cm | 6.2 kg | 6 |
| FG9C3500 | BLA | 18" (45.7 cm) Replacement Blade for FG9C3100 | 18" l x 0.25" w x 2" h | 2.7 lb | 45.7 cm x 0.6 cm x 5.1 cm | 1.2 kg | 6 |
| FG9C3600 | BLA | 24" (61 cm) Replacement Blade for FG9C3200 | 24" l x 0.25" w x 2" h | 3.6 lb | 61 cm x 0.6 cm x 5.1 cm | 1.6 kg | 6 |
| FG9C3700 | BLA | 36" (91.4 cm) Replacement Blade for FG9C3300 | 36" l x 0.25" w x 2" h | 5.2 lb | 91.4 cm x 0.6 cm x 5.1 cm | 2.4 kg | 6 |

*Use with tapered or wood handles; see page 128.

Professional Plastic Squeegees

| NO. | COLOR | DESCRIPTION | U.S. DIMENSIONS | U.S. SHIP WT/CTN | METRIC DIMENSIONS | METRIC SHIP WT/CTN | PACK |
|-----------|-------|--|-------------------------|------------------|---------------------------|--------------------|------|
| FG9C4100* | BLA | 18" (45.7 cm) Plastic Professional Squeegee with Black Dual Moss Rubber | 18" l x 2.3" w x 3.5" h | 6.0 lb | 45.7 cm x 5.8 cm x 8.9 cm | 2.7 kg | 6 |
| FG9C4200* | BLA | 18" (45.7 cm) Plastic Scrub and Dry Squeegee with Black Dual Moss Rubber | 18" l x 2.3" w x 3.5" h | 7.0 lb | 45.7 cm x 5.8 cm x 8.9 cm | 3.2 kg | 6 |

Lobby Pro® Wet/Dry Spill

Quick, safe, and easy cleanup of wet or dry spills.

- Cleaning wand handle allows wide area cleaning without bending
- Soft, natural double-moss blade conforms to uneven surfaces, leaving floors virtually dry to the touch
- Yoke attaches outside pan to help keep hinges free of debris
- Indented footrest lets worker hold pan in place and use two hands while cleaning
- Recessed area contains up to 70.4 oz (2 L) of liquid
- Smooth interior surface for easy cleaning and reduced dirt buildup



FG9M0100

| NO. | COLOR | DESCRIPTION | U.S. DIMENSIONS | U.S. SHIP WT/CTN | METRIC DIMENSIONS | METRIC SHIP WT/CTN | PACK |
|----------|-------|--|--------------------------|------------------|---------------------------|--------------------|------|
| FG9M0100 | BLA | Lobby Pro® Wet/Dry Cleaning Wand | 13.5" l x 1.9" w x 50" h | 5.0 lb | 34.3 cm x 4.8 cm x 127 cm | 2.3 kg | 4 |
| FG253500 | BLA | Lobby Pro® Upright Dust Pan Hanger Bracket | 4" l x 1.25" w x 1.25" h | 0.6 lb | 10.2 cm x 3.2 cm x 3.2 cm | 0.3 kg | 6 |

MAXIMIZER™ Wet/Dry Debris Pan

- Holds 10X More Liquid* for efficient clean up and less rework
- The wide opening allows liquid and solid debris to easily collect in the pan
- Molded-in baffles keep both dry and wet debris from leaking back onto floors
- Holds up to 32oz of liquid
- Comes with convenient Hanger Bracket to hold handles

MAXIMIZER™ Broomgee™

- Double-sided Broomgee™ effectively cleans both liquid and solid spills
- Durable polypropylene bristles effectively sweep up solid debris
- Long-lasting 2.5" TPE squeegee blade handles even the toughest liquid spills
- Broomgee™ easily connects to the Hanger Bracket on Wet/Dry Pan for easy storage

MAXIMIZER™ Heavy Duty Debris Pan

- Extra large opening is wide enough to fit an 18" push broom
- Huge storage capacity reduces trips to empty the pan
- Locking latch for secure lifting and emptying of heavy loads up to 25 lbs.
- Angled, ergonomic handle for reduced strain when sweeping debris into pan
- Durable rear wheels improve wear resistance and extend product life
- Molded comfort handle reduces strain
- Built-in hang hole for convenient storage



| NO. | COLOR | DESCRIPTION | U.S. DIMENSIONS | U.S. SHIP WT/CTN | METRIC DIMENSIONS | METRIC SHIP WT/CTN | PACK |
|---------|-------|---|-----------------------------|------------------|------------------------------|--------------------|------|
| 2018806 | BLACK | Maximizer™ Wet/Dry Debris Pan | 29.0" l x 16.9" w x 12.0" h | 24.03 lb | 73.7 cm x 42.9 cm x 30.5 cm | 10.9 kg | 6 |
| 2018807 | BLACK | Maximizer™ Double Sided Broom/Squeegee | 44.5" l x 4.1" w x 7.0" h | 14.22 lb | 113.1 cm x 10.4 cm x 17.8 cm | 6.45 kg | 8 |
| 2018781 | BLACK | Maximizer™ Heavy-Duty Stand Up Debris Pan | 29.0" l x 20.4" w x 11.0" h | 39.6 lb | 73.7 cm x 51.8 cm x 27.9 cm | 17.96 kg | 6 |

MAXIMIZER™ 3-in-1 Floor Prep Tool

Durable built-in tool attachments deliver easy access and faster cleaning when tackling the toughest messes.

- Gray Scrubber Pad is designed for general cleaning and is made of durable polyester fibers
- Green Scuff Remover Pad lifts stubborn floor scuffs and is made of durable polyester fibers and EVA foam rubber
- Black Scraper removes dry, stuck-on debris and is made of high strength ABS
- Includes lightweight Quick Change Handle for easy tool attachment



| NO. | COLOR | DESCRIPTION | U.S. DIMENSIONS | U.S. SHIP WT/CTN | METRIC DIMENSIONS | METRIC SHIP WT/CTN | PACK |
|---------|-------|---------------------------------------|---------------------------|------------------|------------------------------|--------------------|------|
| 2018782 | BLACK | Maximizer™ 3-in-1 Floor Prep Tool | 57.0" l x 4.6" w x 4.6" h | 11.29 lb | 144.8 cm x 11.7 cm x 11.7 cm | 5.12 kg | 6 |
| 2018784 | GRAY | Maximizer™ 3-in-1 Medium Scrubber Pad | 2.6" l x 1.4" w x 0.3" h | 0.24 lb | 6.6 cm x 3.6 cm x 0.8 cm | 0.11 kg | 12 |
| 2018786 | GREEN | Maximizer™ 3-in-1 Scuff Remover Pad | 2.6" l x 1.4" w x 0.5" h | 0.30 lb | 6.6 cm x 3.6 cm x 1.3 cm | 0.14 kg | 12 |
| 2018787 | BLACK | Maximizer™ 3-in-1 Replaceable Scraper | 2.6" l x 1.5" w x 0.8" h | 0.72 lb | 6.6 cm x 3.8 cm x 2.0 cm | 0.33 kg | 12 |

*vs. standard RCP Lobby Pro® pans

MAXIMIZER™ Quick Change Cleaning Tools

- Make routine cleaning faster by switching between tools in less time
- Increase accessibility to frequently used cleaning tools by adding onboard storage to current carts
- Compatible with existing RCP microfiber pads and duster sleeves* (*sold separately)
- Select from a microfiber frame, duster, squeegee, scrub brush, and floor prep tool. Add a storage tray for convenient access



2018788



2018789



2018790



2018801



2018804



2018802



2018802

| NO. | COLOR | DESCRIPTION | U.S. DIMENSIONS | U.S. SHIP WT/CTN | METRIC DIMENSIONS | METRIC SHIP WT/CTN | PACK |
|---------|--------|--|----------------------------|------------------|-----------------------------|--------------------|------|
| 2018788 | BLACK | Maximizer™ Quick Change Storage Tray | 24.8" l x 19.5" w x 4.0" h | 8.00 lb | 62.9 cm x 49.5 cm x 10.2 cm | 3.6 kg | 1 |
| 2018789 | YELLOW | Maximizer™ Quick Change Extension Handle | 35.5" l x 1.8" w x 1.6" h | 11.3 lb | 90.2 cm x 4.4 cm x 4.1 cm | 5.1 kg | 12 |
| 2018790 | BLACK | Maximizer™ Quick Change Duster | 25.9" l x 2.1" w x 1.3" h | 2.7 lb | 65.7 cm x 5.4 cm x 3.2 cm | 1.2 kg | 6 |
| 2018801 | BLACK | Maximizer™ Quick Change Squeegee | 13.1" l x 10.1" w x 2.1" h | 3.2 lb | 33.3 cm x 25.7 cm x 5.2 cm | 1.5 kg | 6 |
| 2018802 | BLACK | Maximizer™ Quick Change Scrub Brush | 11.4" l x 6.0" w x 2.6" h | 2.9 lb | 28.9 cm x 15.2 cm x 6.7 cm | 1.3 kg | 6 |
| 2018803 | BLACK | Maximizer™ Quick Change Floor Prep Tool | 9.0" l x 4.8" w x 4.8" h | 3.8 lb | 22.9 cm x 12.1 cm x 12.1 cm | 1.7 kg | 6 |
| 2018804 | BLACK | Maximizer™ Quick Change Microfiber Frame | 17.0" l x 3.3" w x 1.5" h | 4.3 lb | 43.2 cm x 8.3 cm x 3.8 cm | 1.9 kg | 6 |
| 2018805 | BLACK | Maximizer™ Quick Change Cleaning Kit | 37.0" l x 7.8" w x 3.2" h | 3.4 lb | 94.0 cm x 19.7 cm x 8.1 cm | 1.5 kg | 1 |



EXECUTIVE
SERIES™



FG618900BLA

In your world, image makes all the difference. Guests expect a higher caliber of service packaged in a more unique atmosphere. Executive Series™ is a sleek line of cleaning solutions designed to elevate your image by allowing staff to blend into the environment with discreet colors, reduced noise, and concealed supplies.

CLEANING CARTS

- High-Capacity Janitorial Cleaning Cart with Bins 138
- High-Security Janitorial Cleaning Carts..... 138
- High-Capacity Janitorial Cleaning Carts..... 139
- Traditional Janitorial Cleaning Carts..... 139

CLEANING AND HOUSEKEEPING CART ACCESSORIES

- Cleaning, Deluxe Paneled, and Compact Housekeeping Cart Accessories..... 140

TRADITIONAL HOUSEKEEPING CARTS AND ACCESSORIES

- Executive Traditional Housekeeping Carts.. 142
- Housekeeping Cart Bumper Kits..... 143
- Traditional Housekeeping Cart Accessories .. 144

QUICK CARTS

- Executive Quick Carts 145
- Executive Quick Cart – Large 146
- Executive Quick Cart – Medium 146
- Executive Quick Cart – Small 146

MECHANICAL SWEEPERS

- Mechanical Sweeper Selection Guide..... 147
- Executive Single-Action Basic Mechanical Sweeper..... 147
- Executive Dual-Action Bristle Mechanical Sweeper..... 147
- Executive Dual-Action Brushless Mechanical Sweeper..... 147

UTILITY REFUSE
AND RECYCLING

DECORATIVE REFUSE

CLEANING

MATERIAL HANDLING

WASHROOM

FOODSERVICE

ACCESSORIES
& INDEX



FG9T7500



UTILITY REFUSE
AND RECYCLING

DECORATIVE REFUSE

CLEANING

MATERIAL HANDLING

WASHROOM

FOODSERVICE

ACCESSORIES
& INDEX

High-Capacity Janitorial Cleaning Cart with Bins

Multifunctional system that is great for microfiber or standard cleaning

- Flexible and configurable to fit your ever-changing cleaning needs
- 30-Qt removable bins offer organization and the ability to pre-stock supplies
- Mop bucket platform with securing grooves keeps WaveBrake® or HYGEN™ microfiber charging buckets in place
- Available components vary in color, size, and function to fit your specific needs (see *Cleaning and Housekeeping Cart Accessories*)



FG9T7300BLA

| NO. | COLOR | DESCRIPTION | U.S. DIMENSIONS | U.S. SHIP WT/CTN | METRIC DIMENSIONS | METRIC SHIP WT/CTN | PACK |
|----------|------------|---|--------------------------|------------------|-------------------------------|--------------------|------|
| FG9T7300 | BLA | Janitorial Cleaning Cart w/Bins – High-Capacity | 48.25" l x 22" w x 44" h | 53.0 lb | 122.6 cm x 55.9 cm x 111.8 cm | 24 kg | 1 |
| FG9T7400 | BLA | Janitorial Cleaning Cart Full Swivel w/Bins – High-Capacity | 48.25" l x 22" w x 44" h | 53.0 lb | 122.6 cm x 55.9 cm x 111.8 cm | 24 kg | 1 |

High-Security Janitorial Cleaning Carts

A complete system solution for cleaning your facility.

- Secure cabinet doors keep supplies concealed and locks secure unattended carts
- Interchangeable handles and removable platform allow user to easily expand or reduce the footprint
- Durable 8" wheels and quiet 4" casters provide easy and quiet maneuverability
- Joint Commission-compliant to meet Environment of Care Standard 3.10.3 with locking doors and hood
- Available components vary in color, size, and function to fit your specific needs (see *Cleaning and Housekeeping Cart Accessories*)

PREASSEMBLED LOCKING SECURITY HOOD

Speeds up assembly and ensures all products will be secure



FG9T7500BLA



WASTE COVER AND STORAGE COMPARTMENT

Provides waste coverage and offers functional storage for personal items.

| NO. | COLOR | DESCRIPTION | U.S. DIMENSIONS | U.S. SHIP WT/CTN | METRIC DIMENSIONS | METRIC SHIP WT/CTN | PACK |
|----------|--------------|---|----------------------------|------------------|-------------------------------|--------------------|------|
| FG9T7500 | BLA | Janitorial Cleaning Cart – High-Security | 48.25" l x 22" w x 53.5" h | 70.0 lb | 122.6 cm x 55.9 cm x 135.9 cm | 31.8 kg | 1 |
| 1861427 | BLACK | Executive Janitorial Cleaning Cart – High-Security | 48.25" l x 22" w x 53.5" h | 70.0 lb | 122.6 cm x 55.9 cm x 135.9 cm | 31.8 kg | 1 |

UTILITY REFUSE AND RECYCLING

DECORATIVE REFUSE

CLEANING

MATERIAL HANDLING

WASHROOM

FOODSERVICE

ACCESSORIES & INDEX

High-Capacity Janitorial Cleaning Cart

Flexible, high-capacity storage solutions and tool organization.

- 7.25-cubic-foot storage capacity offers 40% more space than traditional carts to save time retrieving supplies
- Rubber tool grips securely hold up to 5 stick goods
- Comfort Grip cart handle for easy maneuverability
- Hooks securely hold up to 4 safety signs
- Available components vary in color, size, and function to fit your specific needs (see *Cleaning and Housekeeping Cart Accessories*)



FG9T7200BLA

| NO. | COLOR | DESCRIPTION | U.S. DIMENSIONS | U.S. SHIP WT/CTN | METRIC DIMENSIONS | METRIC SHIP WT/CTN | PACK |
|----------|-------|--|--------------------------------|------------------|------------------------------|--------------------|------|
| FG9T7200 | BLA | Janitorial Cleaning Cart – High-Capacity | 49.75" l x 21.75" w x 38.38" h | 45.0 lb | 126.4 cm x 55.2 cm x 97.5 cm | 20.4 kg | 1 |

Traditional Janitorial Cleaning Carts

Collect waste and transport tools for efficient cleaning.

- Water- and chemical-resistant surface provides easy maintenance and long-lasting good looks
- Front-access zippered bag allows user to easily remove collected waste with no need to lift through the top
- Front platform holds WaveBrake® mop bucket or up to a 32-gallon BRUTE® container
- Add optional Locking Cabinet Doors, Quiet Casters, and Waste Covers



ADD LOCKING CABINET DOORS

Help keep cleaning supplies hidden and secure.



FG617388

EXECUTIVE SERIES™
1861430

| NO. | COLOR | DESCRIPTION | U.S. DIMENSIONS | U.S. SHIP WT/CTN | METRIC DIMENSIONS | METRIC SHIP WT/CTN | PACK |
|----------|-----------|--|------------------------------|------------------|------------------------------|--------------------|------|
| FG617388 | BLA, BLUE | Janitorial Cleaning Cart – Traditional | 46" l x 21.75" w x 38.38" h | 49.5 lb | 116.8 cm x 55.2 cm x 97.5 cm | 22.5 kg | 1 |
| 1861430 | BLACK | Executive Janitorial Cleaning Cart – Traditional | 46" l x 21.75" w x 38.38" h | 49.5 lb | 116.8 cm x 55.2 cm x 97.5 cm | 22.5 kg | 1 |
| 1966719 | YELLOW | 24-Gal. Janitorial Cleaning Cart Vinyl Bag – Traditional | 9.13" l x 6.5" w x 17.25" h | 6.33 lb | 23.2 cm x 16.5 cm x 43.8 cm | 2.87 kg | 4 |
| 1966720 | BLACK | Executive 24-Gal. Janitorial Cleaning Cart Vinyl Bag – Traditional | 9.13" l x 6.5" w x 17.25" h | 5.64 lb | 23.2 cm x 16.5 cm x 43.8 cm | 2.56 kg | 4 |
| FG618100 | YEL | Locking Cabinet Doors | 20" l x 16" w x 11.25" h | 7.83 lb | 50.8 cm x 40.6 cm x 28.6 cm | 3.55 kg | 1 |
| 1861443 | BLACK | Executive Janitorial Cleaning Cart Locking Door Kit – Traditional | 20" l x 16" w x 11.25" h | 7.83 lb | 50.8 cm x 40.6 cm x 28.6 cm | 3.55 kg | 1 |
| FG617900 | BLA | Executive Cart Waste/Bag Lid with Storage – High-Capacity | 17.63" l x 12.5" w x 2.38" h | 3.0 lb | 44.8 cm x 31.8 cm x 6 cm | 1.4 kg | 1 |

Cleaning Cart Accessories

Improve workflow and increase productivity.*

EXECUTIVE 30-GAL. HIGH-CAPACITY CANVAS VINYL-LINED BAG



1966888

VINYL BAG (34 GAL)



1966881

34-GAL. JANITORIAL CLEANING CART VINYL BAGS



1966882, 1966883, 1966884

EXECUTIVE TRIPLE WASTE WIRE BAG DIVIDER



FG9T89010000

EXECUTIVE 10-QT. HEAVY-DUTY CADDIES



FG9T8200BLA

5-QT HEAVY-DUTY PAILS



1857374, 1857375, 1857376, 1857377

30-QT. ORGANIZING BINS, YELLOW



FG9T8400YEL

EXECUTIVE 9-POCKET FABRIC HANGING ORGANIZER



FG9T9000BLA

Bags and Bag Holders

| NO. | COLOR | DESCRIPTION | U.S. DIMENSIONS | U.S. SHIP WT/CTN | METRIC DIMENSIONS | METRIC SHIP WT/CTN | PACK |
|----------|--------|--|---------------------------|------------------|-----------------------------|--------------------|------|
| 1966881 | YELLOW | 34-Gal. Janitorial Cleaning Cart Vinyl Bag – High Capacity | 16.8" l x 10.5" w x 33" h | 13.0 lb | 42.6 cm x 26.6 cm x 83.8 cm | 5.9 kg | 4 |
| FG9T8200 | YEL | 10-Quart Heavy-Duty Caddy | 16.8" l x 10.5" w x 33" h | 13.0 lb | 42.6 cm x 26.6 cm x 83.8 cm | 5.9 kg | 4 |
| 1966886 | BLACK | Executive 34-Gal. Janitorial Cleaning Cart Vinyl Bag – High-Capacity | 16.8" l x 10.5" w x 33" h | 10.8 lb | 42.6 cm x 26.6 cm x 83.8 cm | 4.9 kg | 4 |
| 1966888 | BLACK | Executive 30-Gal. Housekeeping Cart Canvas Vinyl-Lined Bag – High-Capacity | 16.8" l x 10.5" w x 33" h | 17.3 lb | 42.6 cm x 26.6 cm x 83.8 cm | 7.9 kg | 4 |
| 1966882 | RED | 34-Gal. Janitorial Cleaning Cart Vinyl Bag – High-Capacity | 16.8" l x 10.5" w x 33" h | 9.9 lb | 42.6 cm x 26.6 cm x 83.8 cm | 4.5 kg | 4 |
| 1966883 | BLUE | 34-Gal. Janitorial Cleaning Cart Vinyl Bag – High-Capacity | 16.8" l x 10.5" w x 33" h | 9.9 lb | 42.6 cm x 26.6 cm x 83.8 cm | 4.5 kg | 4 |
| 1966884 | GREEN | 34-Gal. Janitorial Cleaning Cart Vinyl Bag – High-Capacity | 16.8" l x 10.5" w x 33" h | 9.9 lb | 42.6 cm x 26.6 cm x 83.8 cm | 4.5 kg | 4 |
| 1966885 | BROWN | 34-Gal. Janitorial Cleaning Cart Vinyl Bag – High-Capacity | 16.8" l x 10.5" w x 33" h | 8.4 lb | 42.6 cm x 26.6 cm x 83.8 cm | 3.8 kg | 4 |
| FG9T9000 | BLA | Executive Fabric 9-Pocket Organizer | 28" l x 19.75" w x 1.5" h | 7.3 lb | 71.1 cm x 50.2 cm x 3.8 cm | 3.3 kg | 6 |
| FG9T8901 | 0000 | Executive Triple Waste Wire Bag Divider | 12.5" l x 3" w x 0.13" h | 2.5 lb | 31.8 cm x 7.6 cm x 0.3 cm | 1.1 kg | 1 |
| 1878368 | | Vacuum Bungees for Carts | N/A | 1.0 lb | N/A | 0.5 kg | 4 |

Pails, Caddies, and Bins

| NO. | COLOR | DESCRIPTION | U.S. DIMENSIONS | U.S. SHIP WT/CTN | METRIC DIMENSIONS | METRIC SHIP WT/CTN | PACK |
|----------|--------|---|---------------------------|------------------|-----------------------------|--------------------|------|
| FG9T8200 | BLA | Executive 10-Quart Heavy-Duty Caddy | 7.5" l x 14" w x 8" h | 10.0 lb | 19.1 cm x 35.6 cm x 20.3 cm | 4.5 kg | 6 |
| 1857376 | BLUE | 5-Quart Pail – Blue | 7.5" l x 9.25" w x 8.5" h | 6.0 lb | 19.1 cm x 23.5 cm x 21.6 cm | 2.7 kg | 4 |
| 1857375 | RED | 5-Quart Pail – Red | 7.5" l x 9.25" w x 8.5" h | 6.0 lb | 19.1 cm x 23.5 cm x 21.6 cm | 2.7 kg | 4 |
| 1857374 | YELLOW | 5-Quart Pail – Yellow | 7.5" l x 9.25" w x 8.5" h | 6.0 lb | 19.1 cm x 23.5 cm x 21.6 cm | 2.7 kg | 4 |
| 1857377 | GREEN | 5-Quart Pail – Green | 7.5" l x 9.25" w x 8.5" h | 6.0 lb | 19.1 cm x 23.5 cm x 21.6 cm | 2.7 kg | 4 |
| 1857378 | BLACK | Executive 5-Quart Heavy-Duty Pail – Black | 7.5" l x 9.25" w x 8.5" h | 6.0 lb | 19.1 cm x 23.5 cm x 21.6 cm | 2.7 kg | 4 |
| FG9T8400 | YEL | 30-Quart Organizing Bins – Yellow | 11" l x 17.5" w x 14" h | 7.0 lb | 27.9 cm x 44.5 cm x 35.6 cm | 3.2 kg | 2 |

*Compatible with all Cleaning Carts, pages 138-139 (excluding FG617388 on page 139)

JANITORIAL CLEANING CART LOCKING DOOR KIT – TRADITIONAL



FG618100YEL

EXECUTIVE LOCKING SECURITY HOOD – HIGH-CAPACITY



FG9T8600BLA

EXECUTIVE WASTE COVER BAG LID WITH STORAGE – HIGH-CAPACITY



FG617900BLA

EXECUTIVE CLEANING CART LOCKING DOOR KIT - HIGH-CAPACITY



1995833

Storage Kits and Casters

| NO. | COLOR | DESCRIPTION | U.S. DIMENSIONS | U.S. SHIP WT/CTN | METRIC DIMENSIONS | METRIC SHIP WT/CTN | PACK |
|----------|-----------|---|-------------------------------|------------------|-----------------------------|--------------------|------|
| FG618100 | YEL | Locking Cabinet Doors | 20" l x 16" w x 11.25" h | 7.83 lb | 50.8 cm x 40.6 cm x 28.6 cm | 3.6 kg | 1 |
| 1861443 | BLA | Executive Janitorial Cleaning Cart Locking Door Kit – Traditional, Black | 19.32" l x 5.45" w x 15.01" h | 7.83 lb | 49.1 cm x 13.8 cm x 19.3 cm | 3.5 kg | 1 |
| FG9T8600 | BLA | Executive Preamsembled Locking Security Hood | 9.5" l x 17" w x 19" h | 8.0 lb | 24.1 cm x 43.2 cm x 48.3 cm | 3.6 kg | 1 |
| FG617900 | BLA | Executive Cart Waste/Bag Lid with Storage – High-Capacity | 17.63" l x 12.5" w x 2.38" h | 3.0 lb | 44.8 cm x 31.8 cm x 6 cm | 1.4 kg | 1 |
| 1868991 | BLACK | Executive Cart Waste/Bag Lid – High-Capacity | 17.63" l x 12.5" w x 2.38" h | 3.0 lb | 44.8 cm x 31.8 cm x 6 cm | 1.4 kg | 1 |
| 1878367* | DARK GRAY | Executive Quiet Caster and Ball-Bearing Wheel Kit | N/A | N/A | N/A | N/A | 1 |

*Compatible with all Cleaning Carts, pages 182-185 (excluding FG617388 on page 183)

**Compatible with Traditional Housekeeping Carts on page 142 and Steel Housekeeping Carts

SLIM JIM® CONTAINER



FG354060GRAY

SLIM JIM® RECYCLING CONTAINER



FG354007BLUE

BRUTE® 44-GALLON CONTAINER



FG264360BLA



BRUTE® 32-GALLON CONTAINER



FG263200GRAY

Slim Jim® and BRUTE® Containers

| NO. | COLOR | DESCRIPTION | U.S. DIMENSIONS | U.S. SHIP WT/CTN | METRIC DIMENSIONS | METRIC SHIP WT/CTN | PACK |
|----------|---------------------------------|--|-----------------------|------------------|-----------------------------|--------------------|------|
| FG354060 | GRAY, BLA, BEIG | Slim Jim® with Venting Channels | 22" l x 11" w x 30" h | 30.6 lb | 55.9 cm x 27.9 cm x 76.2 cm | 13.9 kg | 4 |
| FG354007 | GRN, BLUE | Slim Jim® with Venting Channels – Recycling | 22" l x 11" w x 30" h | 30.6 lb | 55.9 cm x 27.9 cm x 76.2 cm | 13.9 kg | 4 |
| FG263200 | YEL, WHT, RED, GRAY, DGRN, BLUE | BRUTE® 32-Gallon Container | 22" dia x 27.25" h | 49.5 lb | 55.9 cm dia x 69.2 cm | 22.5 kg | 6 |
| 1867531 | BLACK | Executive BRUTE® 32-Gallon Container | 22" dia x 27.25" h | 49.5 lb | 55.9 cm dia x 69.2 cm | 22.5 kg | 6 |
| FG264360 | YEL, RED, GRAY, BLUE, BLA | BRUTE® 44-Gallon Utility Container with Venting Channels | 24" dia x 31.5" h | 49.5 lb | 61 cm dia x 80 cm | 22.5 kg | 4 |

For more options, see *Utility Refuse and Recycling*.

Executive Traditional Housekeeping Carts

A complete system solution for housekeeping in the hospitality industry.

- Durable commercial-grade construction
- Easy-to-clean surfaces and molded-in color
- Durable nonmarking 8" ball bearing casters allow for easy maneuverability
- Standard equipment includes fabric bag, bumpers, vacuum holder, and under-deck shelf
- Available with or without doors or hood
- Full-size cabinet offers exceptional storage space and adjustable middle shelf, add additional shelves for greater organization
- Fully-rounded, user-friendly handles are easy to grip and assist maneuverability
- Optional accessories enhance functionality and productivity
- Impact-absorbing and non-marring bumpers are designed to reduce costly wall damage



EASY TO MAINTAIN
using genuine Rubbermaid Commercial parts. See Component Parts.



SECURE DOORS KEEP SUPPLIES CONCEALED FOR DISCREET FRONT-OF-HOUSE APPEARANCE

FG619100BLA

MESH FABRIC LINEN BAG
Allows quick and easy access to linens.



PROTECTIVE HOOD
Helps hide soaps and cleaning supplies from guests.

FG9T1900BLA

MULTIPLE FABRIC BAG OPTIONS
Rubbermaid offers a variety of fabric bags that allows the user to order the bags that will best fit their needs.



FG619200BLA

| NO. | COLOR | DESCRIPTION | U.S. DIMENSIONS | U.S. SHIP WT/CTN | METRIC DIMENSIONS | METRIC SHIP WT/CTN | PACK |
|------------|------------|--|-------------------------|------------------|-------------------------------|--------------------|------|
| Ⓢ FG618900 | BLA | Executive Full-Size Housekeeping Cart – Traditional | 60" l x 22" w x 50" h | 102.1 lb | 152.4 cm x 55.9 cm x 127 cm | 46.3 kg | 1 |
| Ⓢ FG619000 | BLA | Executive Compact Housekeeping Cart – Traditional | 49" l x 22" w x 50" h | 95.6 lb | 124.5 cm x 55.9 cm x 127 cm | 43.4 kg | 1 |
| Ⓢ FG619100 | BLA | Executive Full-Size Housekeeping Cart with Doors – Traditional | 60" l x 22" w x 50" h | 108.8 lb | 152.4 cm x 55.9 cm x 127 cm | 49.4 kg | 1 |
| Ⓢ FG619200 | BLA | Executive Compact Housekeeping Cart with Doors – Traditional | 49" l x 22" w x 50" h | 102.3 lb | 124.5 cm x 55.9 cm x 127 cm | 46.4 kg | 1 |
| Ⓢ FG9T1900 | BLA | Executive Full-Size Housekeeping Cart with Doors and Hood – Traditional | 60" l x 22" w x 67.5" h | 126.3 lb | 152.4 cm x 55.9 cm x 171.5 cm | 57.3 kg | 1 |
| Ⓢ 1969596 | PLATINUM | Executive Full-Size Housekeeping Cart – Traditional | 60" l x 22" w x 50" h | 102.1 lb | 152.4 cm x 55.9 cm x 127 cm | 46.3 kg | 1 |

UTILITY REFUSE AND RECYCLING

DECORATIVE REFUSE

CLEANING

MATERIAL HANDLING

WASHROOM

FOODSERVICE

ACCESSORIES & INDEX

Executive Compact Housekeeping Cart

Ergonomic and lightweight housekeeping solutions.

- High capacity-to-footprint ratio; only 22" wide
- Multiple accessories available for a customized solution
- Includes locking security hood and cabinet doors, with access from both sides of cart
- 32% more compact size than our FG9T1900 Cart with Doors and Hood
- Two heavy-duty zippered Compact Fabric Bags with waterproof PVC lining



FG9T7800 shown with optional FG9T9000 9-Pocket Fabric Organizer (see page 140 and 144).

EASY TO MAINTAIN

using genuine Rubbermaid Commercial parts. See *Component Parts*.

| NO. | COLOR | DESCRIPTION | U.S. DIMENSIONS | U.S. SHIP WT/CTN | METRIC DIMENSIONS | METRIC SHIP WT/CTN | PACK |
|----------|-------|---|----------------------------|------------------|-------------------------------|--------------------|------|
| FG9T7800 | BLA | Executive Housekeeping Compact Cart – High-Security | 51.75" l x 22" w x 53.5" h | 79 lb | 131.4 cm x 55.9 cm x 135.9 cm | 35.8 kg | 1 |

Housekeeping Cart Bumper Kits

Impact-absorbing and non-marring bumpers are designed to reduce costly wall damage.

- Kits include four commercial-grade bumpers, wire vacuum rack, hardware, and assembly instructions
- Bumper can be retro-fitted onto all housekeeping carts



2067692

| NO. | COLOR | DESCRIPTION | U.S. DIMENSIONS | U.S. SHIP WT/CTN | METRIC DIMENSIONS | METRIC SHIP WT/CTN | PACK |
|---------|-------|---|-------------------------|------------------|-------------------------------|--------------------|------|
| 2067692 | N/A | Bumper Kit for Full Size Housekeeping Carts | 23.5"l x 19.0"w x 3.3"h | 6.7 lb | 59.63 cm x 48.19 cm x 8.34 cm | 3.0 kg | 1 |
| 2067693 | N/A | Bumper Kit for Compact Housekeeping Carts | 23.5"l x 19.0"w x 3.3"h | 6.7 lb | 59.63 cm x 48.19 cm x 8.34 cm | 3.0 kg | 1 |



CANVAS LINEN ACCESSORY BAG



1966887

EXECUTIVE 30-GAL. HIGH-CAPACITY CANVAS VINYL-LINED BAG



1966888

EXECUTIVE 9-POCKET FABRIC HANGING ORGANIZER CART CADDY



FG9T9000BLA

EXECUTIVE EASY SIDE-LOAD LINEN BAG



1966889

Bags

| NO. | COLOR | DESCRIPTION | U.S. DIMENSIONS | U.S. SHIP WT/CTN | METRIC DIMENSIONS | METRIC SHIP WT/CTN | PACK |
|----------|------------|---|---------------------------|------------------|-----------------------------|--------------------|------|
| 1966887 | BROWN | 30-Gal. Housekeeping Cart Canvas Vinyl-Lined Bag – High-Capacity | 16.8" l x 10.5" w x 33" h | 5.8 lb | 42.6 cm x 26.6 cm x 83.8 cm | 2.6 kg | 4 |
| FG9T9000 | BLA | Executive 9-Pocket Fabric Hanging Organizer Cart Caddy | 28" l x 19.75" w x 1.5" h | 7.3 lb | 71.1 cm x 50.2 cm x 3.8 cm | 3.3 kg | 6 |
| 1966889 | BLACK | Executive Side-Load Mesh Linen Bag | 16.8" l x 10.5" w x 33" h | 6.4 lb | 42.6 cm x 26.6 cm x 83.8 cm | 2.9 kg | 4 |
| 1966886 | BLACK | Executive 34-Gal. Janitorial Cleaning Cart Vinyl Bag – High-Capacity | 16.8" l x 10.5" w x 33" h | 10.8 lb | 42.6 cm x 26.6 cm x 83.8 cm | 4.9 kg | 4 |
| 1966888 | BLA | Executive 30-Gal. Housekeeping Cart Canvas Vinyl-Lined Bag – High Capacity | 16.8" l x 10.5" w x 33" h | 17.31 lb | 42.6 cm x 26.6 cm x 83.8 cm | 7.85 kg | 4 |

Traditional Housekeeping Cart Accessories

EXECUTIVE PROTECTIVE SECURITY HOOD FOR TRADITIONAL HOUSEKEEPING CARTS



FG9T0000BLA

EXECUTIVE HOUSEKEEPING CART WASTE/BAG LID – TRADITIONAL



1837785

EXECUTIVE DIVIDED CARRY CADDY, BLACK



1880994

EXECUTIVE LOCKING UTILITY DRAWER – TRADITIONAL



FG619900BLA

Accessories

| NO. | COLOR | DESCRIPTION | U.S. DIMENSIONS | U.S. SHIP WT/CTN | METRIC DIMENSIONS | METRIC SHIP WT/CTN | PACK |
|-----------|------------------|---|-------------------------------|------------------|-----------------------------|--------------------|------|
| FG335388 | BLA | Refuse Bin | 12" l x 17" w x 22" h | 9.0 lb | 30.5 cm x 43.2 cm x 55.9 cm | 4.1 kg | 2 |
| FG335488 | BLA | Utility Bin | 12.13" l x 17" w x 10.5" h | 5.4 lb | 30.8 cm x 43.2 cm x 26.7 cm | 2.4 kg | 2 |
| FG619500 | PLAT, BLA | Executive Adjustable Shelf Kit for Traditional Housekeeping Carts | 30.13" l x 18.5" w x 2.25" h | 5.0 lb | 76.5 cm x 47 cm x 5.7 cm | 2.3 kg | 1 |
| FG619600 | PLAT, BLA | Executive Glass Rack for Traditional Housekeeping Carts | 25.38" l x 21" w x 6.7" h | 2.5 lb | 64.5 cm x 53.3 cm x 17 cm | 1.1 kg | 1 |
| FG619700 | BLA | Executive Locking Door Kit for Traditional Housekeeping Carts | 34" l x 1.88" w x 31.63" h | 6.7 lb | 86.4 cm x 4.8 cm x 80.3 cm | 3 kg | 1 |
| FG619900 | BLA | Executive Locking Utility Drawer – Traditional | N/A | 4.5 lb | N/A | 2 kg | 1 |
| FG9T0000 | PLAT, BLA | Executive Protective Security Hood for Traditional Housekeeping Carts | 31.63" l x 20.38" w x 17.5" h | 21.5 lb | 80.3 cm x 51.8 cm x 44.5 cm | 9.8 kg | 1 |
| 1837785 | BLACK | Executive Housekeeping Cart Waste/Bag Lid – Traditional | 12.28" l x 18.53" w x 0.5" h | 1.7 lb | 31.2 cm x 47.1 cm x 1.3 cm | 0.8 kg | 1 |
| 1880994 | BLACK | Executive Divided Carry Caddy | | | | | 6 |
| 1880995 | GRAY | Executive Divided Carry Caddy | | | | | 6 |
| 1966888 | BLACK | Executive 30-Gal. Housekeeping Cart Canvas Vinyl Lined Bag – High Capacity | 16.8" l x 10.5" w x 33" h | 17.31 lb | 42.6 cm x 26.6 cm x 83.8 cm | 7.85 kg | 4 |
| FG616200 | 0000 | Dual Waste Wire Bag Holder | 12.5" l x 3" w x 0.13" h | 2.5 lb | 31.8 cm x 7.6 cm x 0.3 cm | 1.1 kg | 6 |
| FG616300 | 0000 | Single Waste Wire Bag Holder | 20" l x 16" w x 11.25" h | 7.8 lb | 50.8 cm x 40.6 cm x 28.6 cm | 3.5 kg | 6 |
| 1966889 | BLACK | Executive Side-Load Mesh Linen Bag | 16.8" l x 10.5" w x 33" h | 6.4 lb | 42.6 cm x 26.6 cm x 83.8 cm | 2.9 kg | 4 |
| 1975229** | | Executive 8" Quiet Caster – Swivel Fixed Pack 2 | N/A | N/A | N/A | N/A | 1 |
| 1975230** | | Executive 8" Quiet Caster – Fixed Pack 2 | N/A | N/A | N/A | N/A | 1 |



Executive Quick Carts

The industry's most durable mobile cart solution that empowers staff to maintain areas discreetly and efficiently.

- Provide a premium guest experience, keeping the cleaning process hidden from view of guests
- Easily move throughout the property with a lightweight, compact, and durable construction
- Deliver a flexible solution, customizable for the unique needs of your property



EXECUTIVE SERIES™



Repels Water, Oil, and Stains
Teflon™ fabric protector helps maintain Quick Cart aesthetics and protects from rigorous daily use.



Secured Stick Goods
Heavy-duty fastening strap wraps around supplies to keep them secure while the cart is in motion.



Secure Supplies
Durable lid conceals supplies and features hardware for adding a lock to prevent unauthorized access to cart and its contents.



Heavy-Duty Kick Plate
Reinforced rubberized kick plate for increased durability and reduced wear and tear.

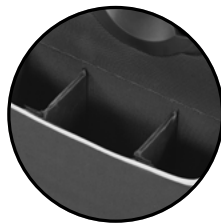

Adjustable Dividers
Dividers can be moved or removed to create multiple compartments to meet your specific cleaning needs.



1902465 Executive Quick Cart – Large



Removable Carry Caddy
Rigid dividers improve efficiency, keeping amenities and supplies organized.

Teflon™ is a registered trademark of Chemours used under license by Rubbermaid Commercial Products LLC.



Executive Quick Cart – Large

- 60-lb capacity
- 3.55 ft³ of total volume capacity
- High-performance polyester for increased durability
- 6 outer pockets (including 1 plastic lined pocket) and 6 inner pockets
- Pockets, caddy, and main compartment include adjustable dividers
- Large removable caddy included
- Removable inner liner for easy cleaning or replacement



| NO. | COLOR | DESCRIPTION | U.S. DIMENSIONS | U.S. CAPACITY | U.S. SHIP WT/CTN | METRIC DIMENSIONS | METRIC CAPACITY | METRIC SHIP WT/CTN | PACK |
|-----------|-----------|--|--------------------------------|---------------------|------------------|--------------------------------------|-----------------|--------------------|------|
| 1902465 | DARK GRAY | Executive Quick Cart – Large | 16.50" L x 14.25" W x 25.00" H | 3.55 ft³ (2.67 ft³) | 21.0 lb | 41.91 cm L x 36.20 cm W x 63.50 cm H | | 9.53 kg | 1 |
| 1902468** | DARK GRAY | Executive Quick Cart Caddy – Large | 14.00" L x 11.00" W x 5.50" H | 0.36 ft³ | 5.09 lb | 35.56 cm L x 27.94 cm W x 13.97 cm H | | 2.31 kg | 2 |
| 1902701 | Black | Executive Quick Cart Liner – Large | 16.00" L x 12.75" W x 22.25" H | | 3.10 lb | 40.64 cm L x 32.39 cm W x 56.52 cm H | | 1.40 kg | 6 |
| 1919270* | Clear | Executive Quick Cart Plastic Pocket Liner | 3.75" L x 4.00" W x 8.50" H | | 0.65 lb | 26.67 cm L x 27.94 cm W x 13.97 cm H | | 0.29 kg | 4 |

*Replacement for all Executive Quick Carts.
 **Replacement for Medium and Large Executive Quick Carts.

Executive Quick Cart – Medium

- 40-lb capacity
- 3.07 ft³ of total volume capacity
- High-performance polyester for increased durability
- 6 outer pockets (including 1 plastic lined pocket) and 6 inner pockets
- Pockets, caddy, and main compartment include adjustable dividers
- Large removable caddy included
- Removable inner liner for easy cleaning or replacement



| NO. | COLOR | DESCRIPTION | U.S. DIMENSIONS | U.S. CAPACITY | U.S. SHIP WT/CTN | METRIC DIMENSIONS | METRIC CAPACITY | METRIC SHIP WT/CTN | PACK |
|-----------|-----------|--|--------------------------------|---------------------|------------------|--------------------------------------|-----------------|--------------------|------|
| 1902466 | DARK GRAY | Executive Quick Cart – Medium | 16.50" L x 14.25" W x 21.00" H | 3.07 ft³ (2.19 ft³) | 19.2 lb | 41.91 cm L x 36.20 cm W x 53.34 cm H | | 8.71 kg | 1 |
| 1902468** | DARK GRAY | Executive Quick Cart Caddy – Large | 14.00" L x 11.00" W x 5.50" H | 0.36 ft³ | 5.09 lb | 35.56 cm L x 27.94 cm W x 13.97 cm H | | 2.31 kg | 2 |
| 1902702 | Black | Executive Quick Cart Liner – Medium | 16.00" L x 12.75" W x 18.50" H | | 2.83 lb | 40.64 cm L x 32.39 cm W x 46.99 cm H | | 1.28 kg | 6 |
| 1919270* | Clear | Executive Quick Cart Plastic Pocket Liner | 3.75" L x 4.00" W x 8.50" H | | 0.65 lb | 26.67 cm L x 27.94 cm W x 13.97 cm H | | 0.29 kg | 4 |

*Replacement for all Executive Quick Carts.
 **Replacement for Medium and Large Executive Quick Carts.

Executive Quick Cart – Small

- 30-lb capacity
- 2.80 ft³ of total volume capacity
- 5 outer pockets and 6 inner pockets
- High-performance polyester for increased durability
- Pockets, caddy, and main compartment include adjustable dividers
- Small removable caddy included
- Removable inner liner for easy cleaning or replacement



| NO. | COLOR | DESCRIPTION | U.S. DIMENSIONS | U.S. CAPACITY | U.S. SHIP WT/CTN | METRIC DIMENSIONS | METRIC CAPACITY | METRIC SHIP WT/CTN | PACK |
|------------|-----------|--|--------------------------------|---------------------|------------------|--------------------------------------|-----------------|--------------------|------|
| 1902467 | DARK GRAY | Executive Quick Cart – Small | 16.50" L x 14.25" W x 17.00" H | 2.80 ft³ (1.72 ft³) | 17.2 lb | 41.91 cm L x 36.20 cm W x 43.18 cm H | | 7.80 kg | 1 |
| 1902459*** | DARK GRAY | Executive Quick Cart Caddy – Small | 10.50" L x 11.00" W x 5.50" H | 0.22 ft³ | 3.72 lb | 26.67 cm L x 27.94 cm W x 13.97 cm H | | 1.69 kg | 2 |
| 1902703 | Black | Executive Quick Cart Liner – Small | 16.00" L x 12.75" W x 14.50" H | | 2.42 lb | 40.64 cm L x 32.39 cm W x 36.83 cm H | | 1.10 kg | 6 |
| 1919270* | Clear | Executive Quick Cart Plastic Pocket Liner | 3.75" L x 4.00" W x 8.50" H | | 0.65 lb | 26.67 cm L x 27.94 cm W x 13.97 cm H | | 0.29 kg | 4 |

*Replacement for all Executive Quick Carts.
 ***Replacement for Small Executive Quick Carts.

Mechanical Sweepers

A complete line of commercial sweepers for hard floors and carpets.

MECHANICAL SWEEPER SELECTION GUIDE

| MECHANICAL SWEEPER FEATURES | FG421588 EXECUTIVE DUAL-ACTION BRUSHLESS MECHANICAL SWEEPER | FG421388 EXECUTIVE DUAL-ACTION BRISTLE MECHANICAL SWEEPER | FG421288 EXECUTIVE SINGLE-ACTION BASIC MECHANICAL SWEEPER |
|----------------------------------|---|---|---|
| L x W | 11 1/4" x 9 1/2" | 11 1/4" x 9 1/2" | 9 1/4" x 9 1/4" |
| Sweeping Path | 7 1/2" | 7 1/2" | 6 1/2" |
| Number of Brushes | Two (Bladed rotors) | Two | One |
| Debris Capacity | 36.8 cu in | 36.8 cu in | 25 cu in |
| Debris Canisters | Two with viewing window | Two | One |
| Corner Brushes | Yes | Yes | Yes |
| Protective Front and Back Bumper | Yes | Yes | Yes |
| Soft Handle Grip | Yes | Yes | Yes |
| Handle Length | 40", threaded | 40", threaded | 40", threaded |
| Handle Width | 5/8" | 5/8" | 5/8" |
| Construction | Galvanized steel | Galvanized steel | Galvanized steel |
| Components | ABS plastic | ABS plastic | ABS plastic |
| Wheels | Soft rubber | Soft rubber | Soft rubber |

Executive Single-Action Basic Mechanical Sweeper

Compact size to collect dust, dirt, and debris in tight spaces.

- Constructed of durable galvanized steel and tough ABS plastic
- Low-profile design provides easy access around and under furniture
- Efficient 6.5" sweep path with protective bumper
- Soft rubber wheels glide easily on any surface
- Easy-to-empty trays
- For carpet, tile, wood, vinyl, and more



BRISTLE BRUSH ROLL



| NO. | COLOR | DESCRIPTION | U.S. DIMENSIONS | U.S. SHIP WT/CTN | METRIC DIMENSIONS | METRIC SHIP WT/CTN | PACK |
|----------|-------|--|-----------------------|------------------|------------------------------|--------------------|------|
| FG421288 | BLA | Executive Single-Action Basic Mechanical Sweeper | 9.5" l x 8" w x 44" h | 15.6 lb | 24.1 cm x 20.3 cm x 111.8 cm | 7.1 kg | 4 |

Executive Dual-Action Bristle Mechanical Sweeper

Two bristle brush rolls provide effective cleaning power to collect dust, dirt, and debris.

- Constructed of durable galvanized steel and tough ABS plastic
- Low-profile design provides easy access around and under furniture
- Efficient 7.5" sweep path with protective bumper
- Soft rubber wheels glide easily on any surface
- Easy-to-empty trays
- For carpet, tile, wood, vinyl, and more



BRISTLE BRUSH ROLL



| NO. | COLOR | DESCRIPTION | U.S. DIMENSIONS | U.S. SHIP WT/CTN | METRIC DIMENSIONS | METRIC SHIP WT/CTN | PACK |
|----------|-------|--|--------------------------|------------------|------------------------------|--------------------|------|
| FG421388 | BLA | Executive Dual-Action Bristle Mechanical Sweeper | 10.5" l x 9.5" w x 44" h | 19.6 lb | 26.7 cm x 24.1 cm x 111.8 cm | 8.9 kg | 4 |

Executive Dual-Action Brushless Mechanical Sweeper

Two agitator rolls provide maximum cleaning power to collect dust, dirt, and debris.

- Constructed of durable galvanized steel and tough ABS plastic
- Low-profile design for easy access around and under furniture
- Wide 7.5" sweep path with protective bumper
- Tinted windows allow you to see when the sweeper needs emptying
- Easy-to-empty trays
- Soft rubber wheels glide easily on any surface
- For carpet, tile, wood, vinyl, and more



RUBBER BRUSH ROLL



| NO. | COLOR | DESCRIPTION | U.S. DIMENSIONS | U.S. SHIP WT/CTN | METRIC DIMENSIONS | METRIC SHIP WT/CTN | PACK |
|----------|-------|--|--------------------------|------------------|------------------------------|--------------------|------|
| FG421588 | BLA | Executive Dual-Action Brushless Mechanical Sweeper | 10.5" l x 9.5" w x 44" h | 19.6 lb | 26.7 cm x 24.1 cm x 111.8 cm | 8.9 kg | 4 |

UTILITY REFUSE AND RECYCLING

DECORATIVE REFUSE

CLEANING

MATERIAL HANDLING

WASHROOM

FOODSERVICE

ACCESSORIES & INDEX



Closet Organizer and Tool Holder

Helps increase productivity and efficiency through better tool storage and access.

- S-hooks hold 5/8" to 1 1/4" diameter handles
- Deep double hooks afford easy accessibility
- Clip holds work notes and instructions

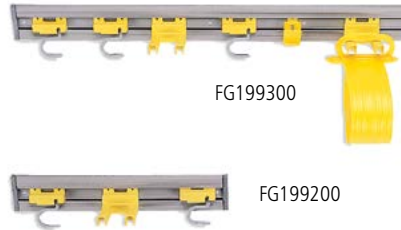

| NO. | COLOR | DESCRIPTION | U.S. DIMENSIONS | U.S. SHIP WT/CTN | METRIC DIMENSIONS | METRIC SHIP WT/CTN | PACK |
|----------|-------------|-------------------------------------|---------------------------|------------------|----------------------------|--------------------|------|
| FG199200 | GRAY | Closet Organizer/Tool Holder Kit | 18" l x 3.25" w x 4.25" h | 6.5 lb | 45.7 cm x 8.3 cm x 10.8 cm | 2.9 kg | 6 |
| FG199300 | GRAY | Closet Organizer/Tool Holder Kit | 34" l x 3.25" w x 4.25" h | 10.3 lb | 86.4 cm x 8.3 cm x 10.8 cm | 4.7 kg | 4 |
| FG199400 | YEL | Value Kit (2 S-Hooks/1 Double Hook) | 3" l x 3.25" w x 4.25" h | 0.4 lb | 7.6 cm x 8.3 cm x 10.8 cm | 0.2 kg | 1 |

Ironing Organizers

Helps prevent hot iron damage.

- Installs easily virtually anywhere
- Efficiently stores iron with ironing board for guest convenience
- Durable heat-resistant thermoset plastic construction
- Aesthetic design complements guest room décor



FG218800



FG245506



FG245506

| NO. | COLOR | DESCRIPTION | U.S. DIMENSIONS | U.S. SHIP WT/CTN | METRIC DIMENSIONS | METRIC SHIP WT/CTN | PACK |
|----------|------------|-------------------|-------------------|------------------|-------------------|--------------------|------|
| FG245506 | WHT | Ironing Organizer | 5.25" l x 15.5" h | 10.5 lb | 13.3 cm x 39.4 cm | 4.8 kg | 6 |
| FG218800 | WHT | Ironing Organizer | 5.75" l x 10" h | 5.4 lb | 14.6 cm x 25.4 cm | 2.4 kg | 4 |

Mobile Two-Step Stepstool

Heavy-duty stepstool glides on retractable rubber casters.

- Supports loads up to 350 lbs
- Soft, slip-resistant pads on both steps
- Wheels retract when stepped on
- Heavy-duty plastic construction minimizes damage to walls and furniture



FG252300

| NO. | COLOR | DESCRIPTION | U.S. DIMENSIONS | U.S. SHIP WT/CTN | METRIC DIMENSIONS | METRIC SHIP WT/CTN | PACK |
|----------|------------------|---------------------------|-------------------|------------------|-----------------------|--------------------|------|
| FG252300 | BLA, BEIG | Mobile Two-Step Stepstool | 16" dia x 13.5" h | 5.9 lb | 40.6 cm dia x 34.3 cm | 2.7 kg | 1 |

UTILITY REFUSE AND RECYCLING

DECORATIVE REFUSE

CLEANING

MATERIAL HANDLING

WASHROOM

FOODSERVICE

ACCESSORIES & INDEX

Executive Spray Bottle, 32-oz.

Makes cleaning easier and more effective.

- Adjustable nozzle, sprays up to 30"
- High-volume 3-cc spray
- Solid HDPE bottle withstands drops and bumps
- Large 3-finger trigger for easy application



EXECUTIVE SERIES
FG9C0306

| NO. | COLOR | DESCRIPTION | U.S. DIMENSIONS | U.S. CAPACITY | U.S. SHIP WT/CTN | METRIC DIMENSIONS | METRIC CAPACITY | METRIC SHIP WT/CTN | PACK |
|----------|-------|--------------------------------|---------------------------|----------------------------|------------------|--------------------------|----------------------------|--------------------|------|
| FG9C0306 | 0000 | Executive Spray Bottle, 32-oz. | 4.8" l x 1.3" w x 13.4" h | 3.3 cm ³ /32 oz | 4.5 lb | 12.2 cm x 3.3 cm x 34 cm | 3.3 cm ³ /0.9 L | 2.1 kg | 12 |

Deluxe Carry Caddy

All-purpose caddy is perfect for carrying tools or cleaning supplies.

- Heavy-duty caddy conveniently fits on cleaning and housekeeping carts
- Securely holds up to eight 32-oz spray bottles and other common cleaning tools
- Ergonomic handle design provides comfortable fit



EXECUTIVE SERIES
1880995



FG315488

| NO. | COLOR | DESCRIPTION | U.S. DIMENSIONS | U.S. SHIP WT/CTN | METRIC DIMENSIONS | METRIC SHIP WT/CTN | PACK |
|----------|-------|-------------------------------|----------------------------|------------------|-----------------------------|--------------------|------|
| FG315488 | BLA | Deluxe Carry Caddy | 15" l x 10.9" w x 7.4" h | 7.5 lb | 38.1 cm x 27.7 cm x 18.8 cm | 3.4 kg | 6 |
| 1880994 | BLACK | Executive Divided Carry Caddy | 15.2" l x 10.8" w x 6.5" h | 1.3 lb | 38.7 cm x 27.3 cm x 16.5 cm | 0.6 kg | 6 |
| 1880995 | GRAY | Executive Divided Carry Caddy | 15.2" l x 10.8" w x 6.5" h | 1.3 lb | 38.7 cm x 27.3 cm x 16.5 cm | 0.6 kg | 6 |

COMPLETE CLEANING SYSTEMS

Rubbermaid Commercial Products' cleaning products are designed to work together to form complete cleaning systems. The FG9C0306 Spray Bottle and Trigger fits smartly in BRUTE® Caddies, and Cleaning Carts.



UTILITY REFUSE AND RECYCLING

DECORATIVE REFUSE

CLEANING

MATERIAL HANDLING

WASHROOM

FOODSERVICE

ACCESSORIES & INDEX



SAFETY





SAFETY SIGNS
 Stable Safety Signs 154
 Hanging Safety Sign 154
 Floor Safety Signs 155
 Executive Wooden Multilingual
 Caution Signs 155
 Site Safety Hanging Signs 155

SAFETY CONES
 Folding Safety Cones 156
 Pop-Up Safety Cones 156
 Safety Cones and Accessories 156

BARRIERS
 Mobile Barrier 157
 Cone Barrier System 157

ABSORBENTS
 Over-the-Spill® System 157
 Spill Mop 158
 Biohazard Spill Mop..... 158

LOOK FOR THE SPECIALLY MARKED EXECUTIVE SERIES™ PRODUCTS.

SAFETY



SPILL MOP



HIGHLY ABSORBENT MATERIALS

Absorbs up to 32 ounces (0.94L) of water and cuts the overall time required to completely remove a spill in half versus a cotton string mop, leaving a safer, drier floor.



CONVENIENT DISPOSAL

Integrated release lever helps avoid contact with soiled mop during disposal.



QUICK ACCESS

Storage cabinet mounts to the wall to keep mop pads and handle close at hand.

BIOHAZARD

SPILL MOP



BETTER HEALTH & SAFETY COMPLIANCE

Biohazard Spill Mop Pad material is designed to absorb up to 13 ounces (0.4L) NaCl 0.9% or 32 ounces (0.94L) of water and turn it into a gel to prevent dripping and help make biohazard spill cleanup safe. The mop easily attaches to the mop head and includes an integrated release lever to dispose of the soiled mop, minimizing contact with hazardous materials.



STORE WHERE SPILLS HAPPEN

Biohazard spills can happen anywhere, including patient rooms and other places where space and storage is limited. The Biohazard Spill Mop Pads come in a compact dispensing carton and the handle is collapsible to fit in drawers or under desks. A mountable storage unit can be placed in high traffic areas.

Spills happen unexpectedly, creating hazards for patrons and staff which need to be cleaned up as quickly as possible to avoid injuries. Using a string mop and bucket can be time consuming and leaves the floor wet. Spill Mop makes it easier to quickly remove liquid spills, leaving the floor dry faster.

3 MILLION  **FOOD SERVICE EMPLOYEES ARE INJURED ANNUALLY AS A RESULT OF SLIPS AND FALLS**

11,000 FATAL FALLS OCCUR IN THE HOSPITAL ANNUALLY 

INJURIES ARE INCREASING AT 10% ANNUALLY 

¹ National Floor Safety Institute
² The Joint Commission Center for Transforming Healthcare

Stable Safety Signs

Unique “no tip” design and bold graphics quickly capture pedestrian attention.

- Folds for convenient storage and transport on Janitor Cart (FG617388) or Rim Caddy (FG9W8700)
- Large, 13" warning triangle with bold graphics
- Only 1½" thick when closed
- Self-opening feet provide a wide, stable base
- Low center of gravity helps prevent tipping when bumped, kicked, or windblown
- ANSI- and OSHA-compliant color and graphics**



FG9S0925

| NO. | COLOR | DESCRIPTION | U.S. DIMENSIONS | U.S. SHIP WT/CTN | METRIC DIMENSIONS | METRIC SHIP WT/CTN | PACK |
|----------|-------|---|--|------------------|---|--------------------|------|
| FG9S09DP | YEL | Stable Safety Sign with "Caution" Imprint, English, Spanish, French | Open: 26" l x 13" w x 13¼" d Closed: 32¼" l x 13" w x 1½" d | 9.5 lb | Open: 66 cm x 33 cm x 33.6 cm Closed: 81.9 cm x 33 cm x 3.8 cm | 4.3 kg | 6 |
| FG9S0925 | YEL | Stable Safety Sign with International Wet Floor Symbol | Open: 26" l x 13" w x 13¼" d Closed: 32¼" l x 13" w x 1½" d | 9.5 lb | Open: 66 cm x 33 cm x 33.6 cm Closed: 81.9 cm x 33 cm x 3.8 cm | 4.3 kg | 6 |

Hanging Safety Sign

An essential safety sign for use in stairways and doors.

- Flexible locking hanger keeps sign in place
- Two-sided design meets OSHA requirements
- ANSI- and OSHA-compliant color and graphics**

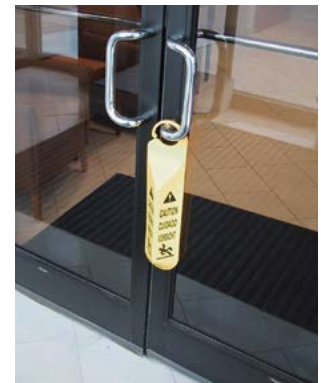

| NO. | COLOR | DESCRIPTION | U.S. DIMENSIONS | U.S. SHIP WT/CTN | METRIC DIMENSIONS | METRIC SHIP WT/CTN | PACK |
|-----------|-------|---|--------------------|------------------|--------------------|--------------------|------|
| FG611000* | YEL | Hanging Safety Sign with Multilingual "Caution" Imprint and Falling Person Symbol | 19.5" l x 4.375" w | 3.0 lb | 49.53 cm x 11.1 cm | 1.4 kg | 6 |

*Custom imprinting available; contact Rubbermaid Customer Service for details.

**ANSI Z535.3—2002 Criteria for Safety Symbols; ANSI Z535—Safety Color; OSHA 1910.144—Safety Color; OSHA 1910.145—Specification for Accident Prevention Signage

Floor Safety Signs

Lightweight, versatile signs for effective safety communication.

- “Closed” and “Caution” warning messages imprinted in English, French, and Spanish
- Folds for convenient storage and transport on janitorial carts or Rim Caddy (FG9W8700)
- Two- and four-sided models available
- ANSI- and OSHA-compliant color* and graphics**



| NO. | COLOR | DESCRIPTION | U.S. DIMENSIONS | U.S. SHIP WT/CTN | METRIC DIMENSIONS | METRIC SHIP WT/CTN | PACK |
|-------------|-------|--|--|------------------|--|--------------------|------|
| FG611200*** | YEL | Floor Sign with Multilingual “Caution” Imprint, 2-Sided | Open: 26" l x 11" w x 25" h Closed: 26" l x 11" w | 15.0 lb | Open: 66 cm x 27.9 cm x 63.5 cm Closed: 66 cm x 27.9 cm | 6.8 kg | 6 |
| 1867505* | BLACK | Executive Multilingual Caution Sign, 2-Sided, Black | Open: 26" l x 11" w x 25" h Closed: 26" l x 11" w | 15.0 lb | Open: 66 cm x 27.9 cm x 63.5 cm Closed: 66 cm x 27.9 cm | 6.8 kg | 6 |
| 1867506* | GRAY | Executive Multilingual Caution Sign, 2-Sided, Gray | Open: 26" l x 11" w x 25" h Closed: 26" l x 11" w | 15.0 lb | Open: 66 cm x 27.9 cm x 63.5 cm Closed: 66 cm x 27.9 cm | 6.8 kg | 6 |
| FG611277 | YEL | Floor Sign with “Caution Wet Floor” Imprint, 2-Sided | Open: 26" l x 11" w x 25" h Closed: 26" l x 11" w | 15.0 lb | Open: 66 cm x 27.9 cm x 63.5 cm Closed: 66 cm x 27.9 cm | 6.8 kg | 6 |
| FG611278 | YEL | Floor Sign with Multilingual “Closed” Imprint, 2-sided | Open: 26" l x 11" w x 25" h Closed: 26" l x 11" w | 15.0 lb | Open: 66 cm x 27.9 cm x 63.5 cm Closed: 66 cm x 27.9 cm | 6.8 kg | 6 |
| FG611400 | YEL | Floor Sign with Multilingual “Caution” Imprint, 4-Sided | Open: 38" l x 12" w x 37" h Closed: 38" l x 12" w | 26.9 lb | Open: 96.5 cm x 30.5 cm x 94 cm Closed: 96.5 cm x 30.5 cm | 12.2 kg | 6 |
| 1867509* | BLACK | Executive Multilingual Caution Sign, 4-Sided, Black | Open: 38" l x 12" w x 37" h Closed: 38" l x 12" w | 26.9 lb | Open: 96.5 cm x 30.5 cm x 94 cm Closed: 96.5 cm x 30.5 cm | 12.2 kg | 6 |
| FG611477 | YEL | Floor Sign with “Caution Wet Floor” Imprint, 4-Sided | Open: 38" l x 12" w x 37" h Closed: 38" l x 12" w | 26.9 lb | Open: 96.5 cm x 30.5 cm x 94 cm Closed: 96.5 cm x 30.5 cm | 12.2 kg | 6 |
| FG618400 | YEL | 20' (6.1 m) Barrier Chain for FG611400 and Safety Cones | 0.25" dia x 20" l x 0.88" w | 5.2 lb | 0.6 cm dia x 50.8 cm x 2.2 cm | 2.4 kg | 4 |

*Applies to yellow signs only. Executive Series™ gray and black Caution Signs are NOT compliant with OSHA nor ANSI color or graphics. FG611278 and FG611478 are NOT compliant with OSHA nor ANSI graphics.

**ANSI Z535.3–2002 Criteria for Safety Symbols; ANSI Z535–Safety Color; OSHA 1910.144–Safety Color; OSHA 1910.145–Specification for Accident Prevention Signage.

***Custom imprinting available; contact Rubbermaid Customer Service for details.

Executive Wooden Multilingual Caution Signs

2-sided hinged Caution signs.

- Elegant dark hardwood frame
- Durable plastic feet help protect wood finish from spills
- Hinged top with integrated carry handle for easy transport and storage
- Available in gold or silver
- Trilingual Caution plate



| NO. | COLOR | DESCRIPTION | U.S. DIMENSIONS | U.S. SHIP WT/CTN | METRIC DIMENSIONS | METRIC SHIP WT/CTN | PACK |
|---------|--------|--|---|------------------|---|--------------------|------|
| 1867507 | GOLD | Executive Wooden Multilingual Caution Sign, 2-Sided, Gold | Open: 22" l x 15½" w x 20" d Closed: 23¾" l x 15½" w x 2¼" d | 13.5 lb | Open: 55.9 cm x 38.4 cm x 50.8 cm Closed: 60.3 cm x 38.4 cm x 5.7 cm | 6.2 kg | 1 |
| 1867508 | SILVER | Executive Wooden Multilingual Caution Sign, 2-Sided, Silver | Open: 22" l x 15½" w x 20" d Closed: 23¾" l x 15½" w x 2¼" d | 13.5 lb | Open: 55.9 cm x 38.4 cm x 50.8 cm Closed: 60.3 cm x 38.4 cm x 5.7 cm | 6.2 kg | 1 |

Site Safety Hanging Signs

Sign and pole combination for blocking doorways and entrances.

- Twisting action secures pole in doorways up to 50" wide to prohibit entry
- Soft, pliable sign rolls around pole for easy storage
- ANSI- and OSHA-compliant color



| NO. | COLOR | DESCRIPTION | U.S. DIMENSIONS | U.S. SHIP WT/CTN | METRIC DIMENSIONS | METRIC SHIP WT/CTN | PACK |
|----------|-------|--|---|------------------|--|--------------------|------|
| FG9S1500 | YEL | Site Safety Hanging Sign with “Closed for Cleaning” Imprint – English Only | Closed: 13" h x 28" w x 1" d Open: 13" h x 50½" w x 1" d | 5.5 lb | 33 cm x 71.12 cm x 2.5 cm 33 cm x 127.6 cm x 2.5 cm | 2.5 kg | 6 |
| FG9S1600 | YEL | Site Safety Hanging Sign with Multilingual “Closed for Cleaning” Imprint | Closed: 13" h x 27¾" w x 1" d Open: 13" h x 50" w x 1" d | 5.5 lb | 33 cm x 70.5 cm x 2.5 cm 33 cm x 127 cm x 2.5 cm | 2.5 kg | 6 |

Folding Safety Cones

Large cone folds with a simple twist and slides into compact shell for handy storage.

- Made of spring steel and durable, easy-clean fabric
- Highly visible—30% more surface area than competitive fabric safety cones
- Large when deployed; compact when folded and stored in shell
- Storage shell mounting hardware includes tape, strap, and screws
- ANSI- and OSHA-compliant color* and graphics**

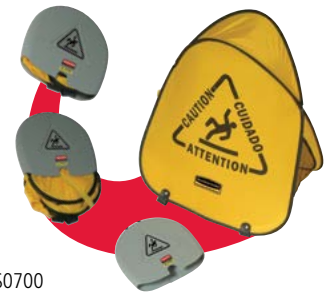

FG9S0700

| NO. | COLOR | DESCRIPTION | U.S. DIMENSIONS | U.S. SHIP WT/CTN | METRIC DIMENSIONS | METRIC SHIP WT/CTN | PACK |
|----------|------------|--|--|------------------|--|--------------------|------|
| FG9S0700 | YEL | Folding Safety Cone with "Caution" Imprint, English, Spanish, French | Opened: 20" h x 18 1/2" w x 13" d Closed: 8" h x 8" w x 1 1/2" d Shell: 9" h x 8 1/4" w x 1 3/4" d | 16.5 lb | Opened: 50.8 cm x 46.6 cm x 33.0 cm Closed: 20.3 cm x 20.3 cm x 3.81 cm Shell: 22.9 cm x 22.2 cm x 4.44 cm | 7.5 kg | 12 |
| FG9S0725 | YEL | Folding Safety Cone with International Wet Floor Symbol | Opened: 20" h x 18 1/2" w x 13" d Closed: 8" h x 8" w x 1 1/2" d Shell: 9" h x 8 1/4" w x 1 3/4" d | 16.5 lb | Opened: 50.8 cm x 46.6 cm x 33.0 cm Closed: 20.3 cm x 20.3 cm x 3.81 cm Shell: 22.9 cm x 22.2 cm x 4.44 cm | 7.5 kg | 12 |

Pop-Up Safety Cones

Collapsible, automatically deployable cone.

- Durable cone material withstands rough handling
- Wall-mounted, shatterproof storage tube provides easy and compact storage
- Storage tube mounting hardware includes tape and screws
- ANSI- and OSHA-compliant color* and graphics**



FG9S0000

| NO. | COLOR | DESCRIPTION | U.S. DIMENSIONS | U.S. SHIP WT/CTN | METRIC DIMENSIONS | METRIC SHIP WT/CTN | PACK |
|----------|------------|--|-------------------------|------------------|---------------------------------|--------------------|------|
| FG9S0000 | YEL | Pop-Up Safety Cone, 20" (50.8 cm) with Multilingual "Caution" Imprint and Wet Floor Symbol | 21" dia x 21" w x 20" h | 12.7 lb | 53.3 cm dia x 53.3 cm x 50.8 cm | 5.8 kg | 12 |
| FG9S0100 | YEL | Pop-Up Safety Cone, 30" (76.2 cm) with Multilingual "Caution" Imprint and Wet Floor Symbol | 21" dia x 21" w x 30" h | 23.5 lb | 53.3 cm dia x 53.3 cm x 76.2 cm | 10.7 kg | 12 |

Safety Cones and Accessories

Highly visible, bright yellow hazard protection system.

- Versatile top design accommodates barricade belt, flashing light, lock-in sign holder, and Audio Guard® accessories
- Four-sided shape for efficient stacking
- Multilingual imprinted warning messages provide effective communication with broad audiences
- Molded-in slots for easy handling
- Can be used with BRUTE® Square Dolly (FG353000) for easy transport
- ANSI- and OSHA-compliant color*



| NO. | COLOR | DESCRIPTION | U.S. DIMENSIONS | U.S. SHIP WT/CTN | METRIC DIMENSIONS | METRIC SHIP WT/CTN | PACK |
|-------------|------------|---|--------------------------------|------------------|-------------------------------|--------------------|------|
| FG353000 | BLA | BRUTE® Square Dolly | 17.25" sq x 6.25" h | 18.5 lb | 43.8 cm sq x 15.9 cm | 8.4 kg | 2 |
| FG618400 | YEL | 20" (50.8 cm) Barrier Chain for G611400 and Safety Cones | 0.25" dia x 20" l x 0.88" w | 5.2 lb | 0.6 cm dia x 50.8 cm x 2.2 cm | 2.4 kg | 4 |
| FG627600*** | YEL | Safety Cone 36" (91.4 cm) with Multilingual "Caution" Imprint | 12.25" l x 12.25" w x 36" h | 17.6 lb | 31.1 cm x 31.1 cm x 91.4 cm | 8 kg | 5 |
| FG627677 | YEL | Safety Cone 36" (91.4 cm) with Multilingual "Caution Wet Floor" Imprint | 12.25" l x 12.25" w x 36" h | 17.6 lb | 31.1 cm x 31.1 cm x 91.4 cm | 8 kg | 5 |
| FG627687 | YEL | Safety Cone 36" (91.4 cm) with Multilingual "Caution Safety First" Imprint | 12.25" l x 12.25" w x 36" h | 17.6 lb | 31.1 cm x 31.1 cm x 91.4 cm | 8 kg | 5 |
| FG627700*** | YEL | Safety Cone 25.75" (65.4 cm) with Multilingual "Caution" Imprint | 10.5" l x 10.5" w x 25.75" h | 14.0 lb | 26.7 cm x 26.7 cm x 65.4 cm | 6.4 kg | 6 |
| FG627777 | YEL | Safety Cone 25.75" (65.4 cm) with Multilingual "Caution Wet Floor" Imprint | 10.5" l x 10.5" w x 25.75" h | 14.0 lb | 26.7 cm x 26.7 cm x 65.4 cm | 6.4 kg | 6 |
| FG628400 | BLA | Weight Ring – Single for all 36" (91.4 cm) Safety Cones | 12.5" l x 12.5" w x 1" h | 10.0 lb | 31.8 cm x 31.8 cm x 2.5 cm | 4.5 kg | 1 |
| FG628700 | YEL | Cone Barricade System Consists of FG627600, (1) Belt Cassette, and (1) Double Weight Ring | 12.25" l x 12.25" w x 39.75" h | 27.2 lb | 31.1 cm x 31.1 cm x 101 cm | 12.3 kg | 1 |

*Applies to yellow signs only.

**ANSI Z535.3–2002 Criteria for Safety Symbols; ANSI Z535–Safety Color; OSHA 1910.144–Safety Color; OSHA 1910.145–Specification for Accident Prevention Signage.

***Custom imprinting available; contact Rubbermaid Customer Service for details.

UTILITY REFUSE AND RECYCLING

DECORATIVE REFUSE

SAFETY

MATERIAL HANDLING

WASHROOM

FOODSERVICE

ACCESSORIES & INDEX

Mobile Barrier

Easy to use, highly visible mobile barrier for use in many situations.

- Flexible panels allow straight, curved, and circular configurations
- Extends to 13' when fully opened; locking straps keep barrier closed when not in use
- Lightweight and compact (2' x 13" footprint when closed)
- ANSI- and OSHA-compliant color
- For indoor use; shipped assembled



FG9S1100

Work around electrical equipment?

Excerpt from OSHA reg. 29 CFR 1910.335 (b)(2): "Barricades shall be used...to prevent or limit employee access to work areas...Conductive [metal] barricades may not be used where they might cause an electrical contact hazard."

| NO. | COLOR | DESCRIPTION | U.S. DIMENSIONS | U.S. SHIP WT/CTN | METRIC DIMENSIONS | METRIC SHIP WT/CTN | PACK |
|----------|-------|----------------|--|------------------|---|--------------------|------|
| FG9S1100 | YEL | Mobile Barrier | Open: 40" h x 13' l x 1" w Closed: 40" h x 2' l x 13" w | 37.0 lb | Open: 101.6 cm x 396 cm x 2.54 cm Closed: 101.6 cm x 61.0 cm x 33.0 cm | 16.8 kg | 1 |

Cone Barrier System

Complete, expandable system for quick deployment.

FG628700 includes:

- One 36" four-sided FG627600 Safety Cone
- One steel double weight ring (27.2 lbs)
- One belt cassette (7 ft x 3 in)
- ANSI- and OSHA-compliant color* and graphics**
- Expand the system with additional FG628700 units
- Stackable, can be used with BRUTE® Square Dolly (FG353000) for easy transport



FG628700 (2 qty.)

| NO. | COLOR | DESCRIPTION | U.S. DIMENSIONS | U.S. SHIP WT/CTN | METRIC DIMENSIONS | METRIC SHIP WT/CTN | PACK |
|----------|-------|---|--------------------------------|------------------|----------------------------|--------------------|------|
| FG353000 | BLA | BRUTE® Square Dolly | 17.25" sq x 6.25" h | 18.5 lb | 43.8 cm sq x 15.9 cm | 8.4 kg | 2 |
| FG628700 | YEL | Cone Barricade System Consists of FG627600, (1) Belt Cassette, and (1) Double Weight Ring | 12.25" l x 12.25" w x 39.75" h | 27.2 lb | 31.1 cm x 31.1 cm x 101 cm | 12.3 kg | 1 |

Over-the-Spill® System

Slip-resistant pads quickly cover spills and alert pedestrians.

- Each yellow pad is coded with universal caution symbol and "Caution Wet Floor" message in English and Spanish
- Dispensing station mounts on flat surfaces
- Pads absorb up to 14oz of liquid for faster cleanup



FG425100



FG425500



FG425400



FG425400 on FG611200

| NO. | COLOR | DESCRIPTION | U.S. DIMENSIONS | U.S. SHIP WT/CTN | METRIC DIMENSIONS | METRIC SHIP WT/CTN | PACK |
|----------|-------|--|------------------------|------------------|----------------------------|--------------------|------|
| FG425100 | YEL | Over-the-Spill® Station Kit includes Pad Dispenser, 22 Large Pads, and Fasteners | 21" l x 17.75" w | 14.0 lb | 53.3 cm x 45.1 cm | 6.4 kg | 6 |
| FG425200 | YEL | Over-the-Spill® Station Pads, Large; Refill Pads for FG425100, Contains 22 Pads | 20" l x 16.5" w | 25.0 lb | 50.8 cm x 41.9 cm | 11.3 kg | 12 |
| FG425300 | YEL | Over-the-Spill® Station Pads, Medium; Refill Pads for FG425100, Contains 22 Pads | 16.5" l x 14" w | 17.0 lb | 41.9 cm x 35.6 cm | 7.7 kg | 12 |
| FG425400 | YEL | Over-the-Spill® Pad Tablet, Contains 22 Pads | 16.5" l x 14" w | 20.0 lb | 41.9 cm x 35.6 cm | 9.1 kg | 12 |
| FG425500 | YEL | Over-the-Spill® Mini Tablet, Contains 22 Pads | 17" l x 7" w x 1.25" h | 8.7 lb | 43.2 cm x 17.8 cm x 3.2 cm | 3.9 kg | 12 |

*Applies to yellow signs only.

**ANSI Z535.3-2002 Criteria for Safety Symbols; ANSI Z535-Safety Color; OSHA 1910.144-Safety Color; OSHA 1910.145-Specification for Accident Prevention Signage.

Spill Mop

- 10-pack dispensing carton is compact enough to fit easily in most spaces
- Each pad is made with highly absorbent material designed for quickly removing liquid, water-based spills
- Absorbed liquid is turned to gel, trapping it inside to prevent leaks and drips
- Each pad holds up to 32 ounces of water
- For use with 2017061 Spill Mop Handle.
- Up to two packs can fit neatly in 2017162 Spill Mop Storage Cabinet for convenient access



2017059



2017061



2017162



2031093

| ITEM # | DESCRIPTION | COLOR | COLLAPSED LENGTH | EXTENDED LENGTH | WIDTH | HEIGHT | DEPTH | PACK |
|---------|---------------------------|--------|------------------|-----------------|--------|--------|-------|------|
| 2017059 | Spill Mop Pads 10 ct | GRAY | N/A | N/A | 7.30" | 10.00" | 3.34" | 10 |
| 2017061 | Spill Mop Handle | YELLOW | 22.18" | 47.54" | 3.99" | N/A | N/A | 12 |
| 2017162 | Spill Mop Storage Cabinet | GRAY | N/A | N/A | 13.27" | 24.60" | 4.00" | 1 |
| 2031093 | Spill Mop Kit* | GRAY | N/A | N/A | 13.27" | 24.60" | 4.00" | 1 |

*Includes: 1 Spill Mop Pads 10 ct, 1 Spill Mop Handle, and 1 Spill Mop Storage Cabinet

Biohazard Spill Mop

- 10 pack dispensing carton is compact enough to fit easily in most spaces
- Each pad is made with highly absorbent material designed for quickly removing liquid biohazard spills.
- Absorbed liquid is turned to gel, trapping it inside to prevent leaks and drips
- Each pad holds up to 32 ounces of water and 13.5 ounces of NaCl 0.9%
- For use with 2017061 Spill Mop Handle.
- Up to two packs can fit neatly in 2017162 Spill Mop Storage Cabinet for convenient access



2017060



2017061



2017162



2031094

| ITEM # | DESCRIPTION | COLOR | COLLAPSED LENGTH | EXTENDED LENGTH | WIDTH | HEIGHT | DEPTH | PACK |
|---------|--------------------------------|--------|------------------|-----------------|--------|--------|-------|------|
| 2017060 | Biohazard Spill Mop Pads 10 ct | GRAY | N/A | N/A | 7.30" | 10.00" | 3.34" | 10 |
| 2017061 | Spill Mop Handle | YELLOW | 22.18" | 47.54" | 3.99" | N/A | N/A | 12 |
| 2017162 | Spill Mop Storage Cabinet | GRAY | N/A | N/A | 13.27" | 24.60" | 4.00" | 1 |
| 2031094 | Biohazard Spill Mop Kit* | GRAY | N/A | N/A | 13.27" | 24.60" | 4.00" | 1 |

*Includes: 1 Biohazard Spill Mop Pads 10 ct, 1 Spill Mop Handle, and 1 Spill Mop Storage Cabinet



UTILITY REFUSE
AND RECYCLING

DECORATIVE REFUSE

SAFETY

MATERIAL HANDLING

WASHROOM

FOODSERVICE

ACCESSORIES
& INDEX

UTILITY REFUSE
AND RECYCLING



MATERIAL HANDLING

DECORATIVE REFUSE

CLEANING

MATERIAL HANDLING

WASHROOM

FOODSERVICE

ACCESSORIES
& INDEX

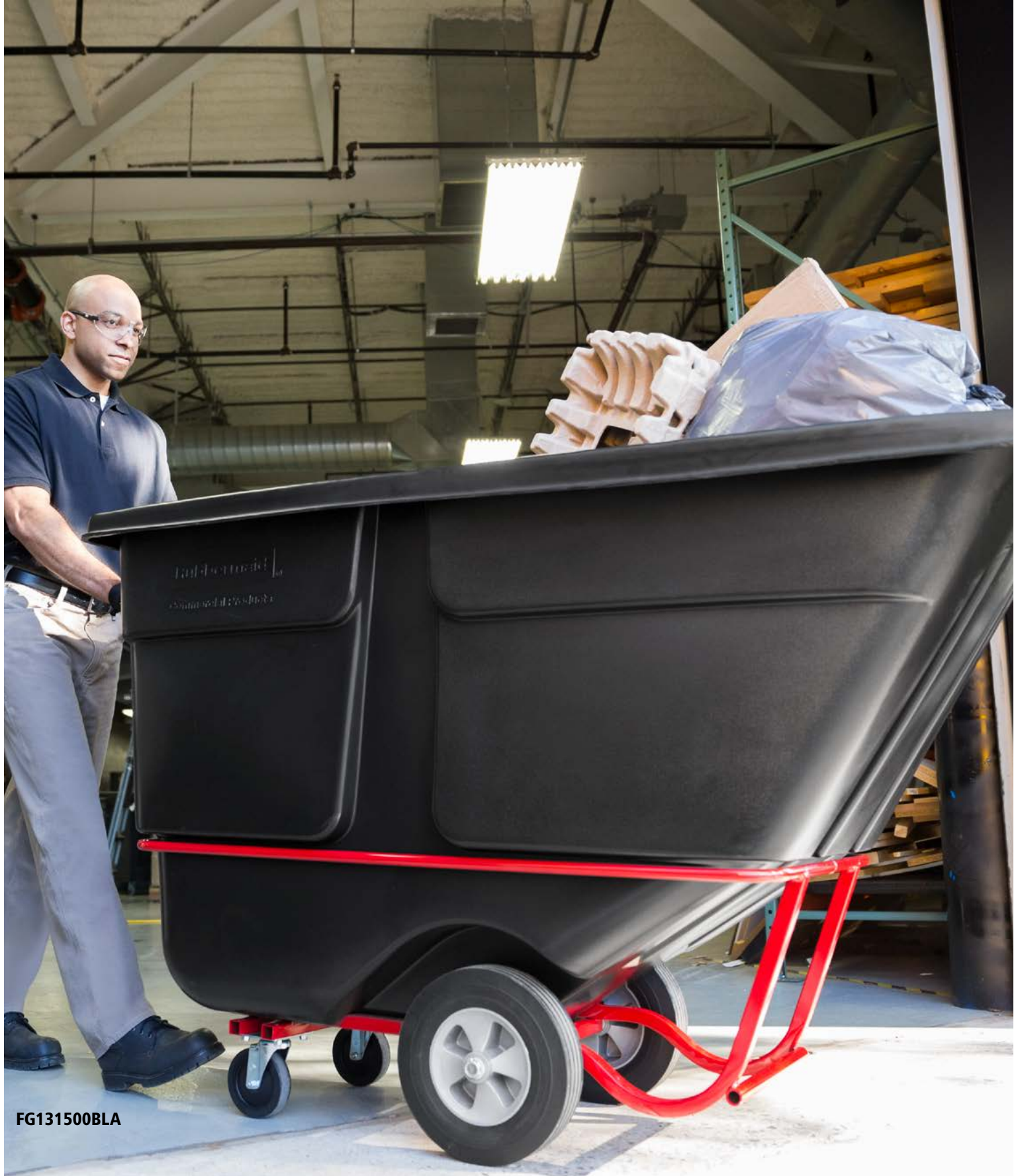

FG131500BLA



FG9T6800BLA

MATERIAL HANDLING

BULK COLLECTION

| | |
|-------------------------------------|-----|
| Structural Foam Tilt Trucks | 164 |
| Rotomolded Tilt Trucks..... | 165 |
| Heavy-Duty Tilt Trucks..... | 166 |
| Heavy-Duty Tilt Truck Lids..... | 166 |
| Self-Dumping Hoppers..... | 167 |
| Mega BRUTE® Mobile Collectors | 167 |
| Cube Trucks | 168 |
| Collapsible X-Carts..... | 169 |

UTILITY CARTS

| | |
|---|-----|
| Heavy-Duty Adaptable Cart | 171 |
| Heavy-Duty Utility Carts..... | 172 |
| Trades Carts..... | 174 |
| 5-Drawer Mobile Work Center..... | 174 |
| TradeMaster® Mobile Cabinets and Work Centers..... | 175 |
| Convertible Utility Cart..... | 175 |
| Executive Series™ Service Cart | 176 |
| Service Carts..... | 177 |
| Xtra™ Carts..... | 177 |

PLATFORM TRUCKS

| | |
|---|-----|
| Heavy-Duty Platform Trucks | 179 |
| Sheet and Panel Trucks and A-Frame Panel Trucks..... | 180 |
| Side-Panel Platform Trucks | 181 |

CASTERS TO MEET YOUR NEEDS

| | |
|---------------------------------|-----|
| Casters to Meet Your Needs..... | 182 |
|---------------------------------|-----|

CART ACCESSORIES

| | |
|-----------------------|-----|
| Cart Accessories..... | 183 |
|-----------------------|-----|

OUTDOOR HANDLING AND STORAGE

| | |
|---------------------------------|-----|
| Stock Tanks..... | 185 |
| Big Wheel® Carts | 186 |
| Heavy-Duty Big Wheel® Cart..... | 186 |
| Utility Lawn Carts | 186 |

STORAGE

| | |
|---------------------------------------|-----|
| BRUTE® Totes..... | 187 |
| Stack and Nest Palletote® Boxes | 187 |



UTILITY REFUSE
AND RECYCLING

DECORATIVE REFUSE

CLEANING

MATERIAL HANDLING

WASHROOM

FOODSERVICE

ACCESSORIES
& INDEX

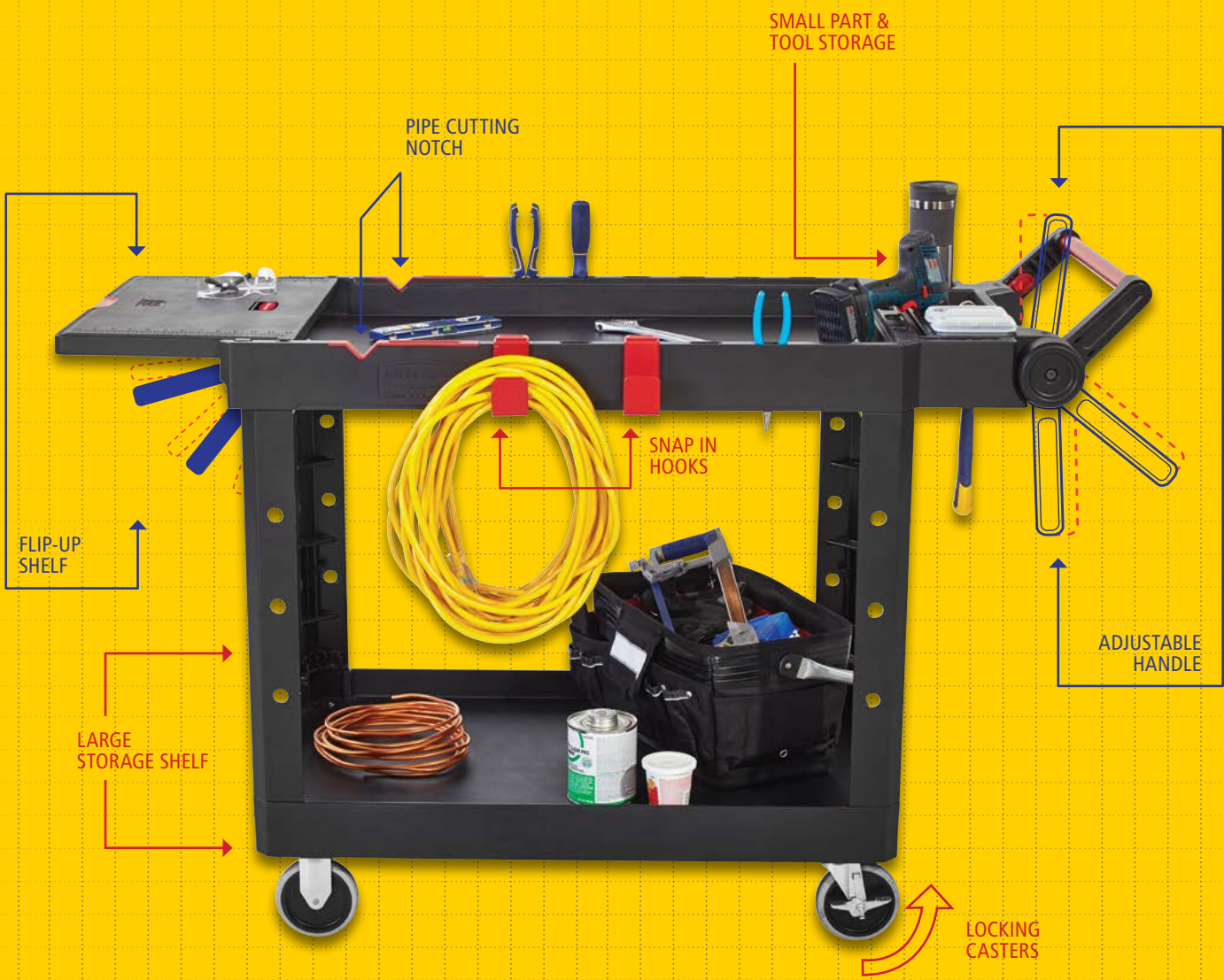

HEAVY-DUTY ADAPTABLE CART

HANDLES ANY JOB



ADJUSTS TO 4 POSITIONS

Variety of positions to accommodate users of all heights for improved control and comfort.



FLIP-UP SHELF

Eliminates the need to clear top shelf contents for work space. Perfect for laptop use or small part assembly.



CONVERTIBLE TOP SHELF

Supports 1/2" piece of plywood to adapt top shelf into flat work surface for larger items and tasks.



SLOTS AROUND RIM

Accommodate small hand tools like wrenches, pliers, or screwdrivers for quick, easy access.



SMALL PART AND TOOL STORAGE

Keep hardware and tools organized for quick retrieval. Tablet and cup holder also included.

UTILITY REFUSE
AND RECYCLING

DECORATIVE REFUSE

CLEANING

MATERIAL HANDLING

WASHROOM

FOODSERVICE

ACCESSORIES
& INDEX

Structural Foam Tilt Trucks

Durable molded trucks handle heavy loads with ease.

- Ergonomic handles for better handling and steering
- Frameless design supports USDA Meat and Poultry Equipment Compliance
- Unibody design promotes a more discreet appearance in public areas
- Fits through standard commercial doorways and onto elevators easily
- Optional domed lid available



FG101100



The ergonomically designed “steering wheel” handle provides excellent handling and maneuvering.



Inset wheel position prevents damage to surroundings.



FG102800

½-Cubic-Yard Tilt Trucks

| NO. | COLOR | DESCRIPTION | U.S. DIMENSIONS | U.S. SIZE | U.S. CAPACITY | U.S. SHIP WT/CTN | METRIC DIMENSIONS | METRIC SIZE | METRIC CAPACITY | METRIC SHIP WT/CTN | PACK |
|----------|------------|---|--------------------------------|-----------|---------------|------------------|------------------------------|--------------------|-----------------|--------------------|------|
| FG9T1300 | BLA | Structural Foam Tilt Truck, Utility-Duty | 57.38" l x 26.88" w x 33.88" h | ½ cu yd | 450 lb | 86.9 lb | 145.7 cm x 68.3 cm x 86.1 cm | 0.4 m ³ | 204.1 kg | 39.4 kg | 1 |
| FG9T1400 | BLA | Structural Foam Tilt Truck, Standard-Duty | 57.38" l x 26.88" w x 33.88" h | ½ cu yd | 850 lb | 95.9 lb | 145.7 cm x 68.3 cm x 86.1 cm | 0.4 m ³ | 385.6 kg | 43.5 kg | 1 |
| FG9T2200 | BLA | Lid for ½-Cubic-Yard Tilt Trucks | 52" l x 27.88" w x 9" h | N/A | N/A | 25.3 lb | 132.1 cm x 70.8 cm x 22.9 cm | N/A | N/A | 11.5 kg | 1 |

¾-Cubic-Yard Tilt Trucks

| NO. | COLOR | DESCRIPTION | U.S. DIMENSIONS | U.S. SIZE | U.S. CAPACITY | U.S. SHIP WT/CTN | METRIC DIMENSIONS | METRIC SIZE | METRIC CAPACITY | METRIC SHIP WT/CTN | PACK |
|----------|------------|---|----------------------------|-----------|---------------|------------------|------------------------------|-------------------|-----------------|--------------------|------|
| FG101100 | BLA | Structural Foam Tilt Truck, Utility-Duty | 64.5" l x 30.25" w x 38" h | ¾ cu yd | 600 lb | 92.0 lb | 163.8 cm x 76.8 cm x 96.5 cm | .6 m ³ | 272.1 kg | 41.7 kg | 1 |
| FG101300 | BLA | Structural Foam Tilt Truck, Standard-Duty | 64.5" l x 30.25" w x 38" h | ¾ cu yd | 1,000 lb | 101.0 lb | 163.8 cm x 76.8 cm x 96.5 cm | .6 m ³ | 453.6 kg | 45.8 kg | 1 |
| FG102800 | BLA | Lid for ¾-Cubic-Yard Tilt Trucks | 61" l x 31.75" w x 8.75" h | N/A | N/A | 24.8 lb | 154.9 cm x 80.6 cm x 22.2 cm | N/A | N/A | 11.2 kg | 1 |

1-Cubic-Yard Tilt Trucks

| NO. | COLOR | DESCRIPTION | U.S. DIMENSIONS | U.S. SIZE | U.S. CAPACITY | U.S. SHIP WT/CTN | METRIC DIMENSIONS | METRIC SIZE | METRIC CAPACITY | METRIC SHIP WT/CTN | PACK |
|----------|------------|---|-------------------------------|-----------|---------------|------------------|-------------------------------|-------------------|-----------------|--------------------|------|
| FG9T1500 | BLA | Structural Foam Tilt Truck, Standard-Duty | 70.75" l x 33.5" w x 42.25" h | 1 cu yd | 1,250 lb | 139.1 lb | 179.7 cm x 85.1 cm x 107.3 cm | .8 m ³ | 566.9 kg | 63.1 kg | 1 |
| FG9T1600 | BLA | Structural Foam Tilt Truck, Heavy-Duty | 70.75" l x 33.5" w x 42.25" h | 1 cu yd | 2,100 lb | 141.1 lb | 179.7 cm x 85.1 cm x 107.3 cm | .8 m ³ | 952.5 kg | 64.0 kg | 1 |
| FG9T2300 | BLA | Lid for 1-Cubic-Yard Tilt Trucks | 66.88" l x 34.5" w x 9" h | N/A | N/A | 36.6 lb | 169.9 cm x 87.6 cm x 22.9 cm | N/A | N/A | 16.6 kg | 1 |

UTILITY REFUSE AND RECYCLING

DECORATIVE REFUSE

CLEANING

MATERIAL HANDLING

WASHROOM

FOODSERVICE

ACCESSORIES & INDEX

Rotomolded Tilt Trucks

Durable rotational molded trucks handle heavy loads with ease.

- Easy to handle and maneuver
- Inset wheels protect walls and fixtures



FG130573



FG131400BLA

½-Cubic-Yard Tilt Trucks

| NO. | COLOR | DESCRIPTION | U.S. DIMENSIONS | U.S. SIZE | U.S. CAPACITY | U.S. SHIP WT/CTN | METRIC DIMENSIONS | METRIC SIZE | METRIC CAPACITY | METRIC SHIP WT/CTN | PACK |
|-----------|----------------------|--|-----------------------------|-----------|---------------|------------------|------------------------------|-------------|-----------------|--------------------|------|
| FG9T1700 | BLA | Tilt Truck (RM) | 56.75" l x 28" w x 38.63" h | ½ cu yd | 300 lb | 138.5 lb | 144.1 cm x 71.1 cm x 98.1 cm | 0.4 m³ | 136.1 kg | 62.8 kg | 3 |
| FG130400 | BLA | Tilt Truck, Utility-Duty (RM) | 56.75" l x 28" w x 38.63" h | ½ cu yd | 450 lb | 62.5 lb | 144.1 cm x 71.1 cm x 98.1 cm | 0.4 m³ | 204.1 kg | 28.3 kg | 1 |
| FG130500 | YEL, RED, DBLUE, BLA | Tilt Truck, Standard-Duty (RM) | 60.5" l x 28" w x 38.63" h | ½ cu yd | 850 lb | 77.0 lb | 153.7 cm x 71.1 cm x 98.1 cm | 0.4 m³ | 385.6 kg | 34.9 kg | 1 |
| FG130573 | BLUE | Recycling Tilt Truck, Standard-Duty (RM) | 60.5" l x 28" w x 38.63" h | ½ cu yd | 850 lb | 77.0 lb | 153.7 cm x 71.1 cm x 98.1 cm | 0.4 m³ | 385.6 kg | 34.9 kg | 1 |
| FG130600* | BLA | Tilt Truck, Heavy-Duty (RM) | 60.5" l x 28" w x 38.63" h | ½ cu yd | 1,400 lb | 88.0 lb | 153.7 cm x 71.1 cm x 98.1 cm | 0.4 m³ | 635.0 kg | 39.9 kg | 1 |
| FG130700* | BLA | Lid for ½ Cubic Yard Tilt Trucks | 56.5" l x 28.5" w x 9" h | N/A | N/A | 22.3 lb | 143.5 cm x 72.4 cm x 22.9 cm | N/A | N/A | 10.1 kg | 1 |

1-Cubic-Yard Tilt Trucks

| NO. | COLOR | DESCRIPTION | U.S. DIMENSIONS | U.S. SIZE | U.S. CAPACITY | U.S. SHIP WT/CTN | METRIC DIMENSIONS | METRIC SIZE | METRIC CAPACITY | METRIC SHIP WT/CTN | PACK |
|-----------|----------------------|--|-------------------------------|-----------|---------------|------------------|-------------------------------|-------------|-----------------|--------------------|------|
| FG9T1800 | BLA | Tilt Truck | 72.25" l x 33.5" w x 43.75" h | 1 cu yd | 600 lb | 259.5 lb | 183.5 cm x 85.1 cm x 111.1 cm | 0.8 m³ | 272.1 kg | 117.7 kg | 3 |
| FG131400 | BLA | Tilt Truck, Utility-Duty (RM) | 72.25" l x 33.5" w x 43.75" h | 1 cu yd | 850 lb | 111.0 lb | 183.5 cm x 85.1 cm x 111.1 cm | 0.8 m³ | 385.6 kg | 50.3 kg | 1 |
| FG131500 | YEL, RED, DBLUE, BLA | Tilt Truck, Standard-Duty (RM) | 72.25" l x 33.5" w x 43.75" h | 1 cu yd | 1,250 lb | 111.0 lb | 183.5 cm x 85.1 cm x 111.1 cm | 0.8 m³ | 567.0 kg | 50.3 kg | 1 |
| 2089826 | BLUE | Recycling Tilt Truck, Standard-Duty (RM) | 72.25" l x 33.5" w x 43.75" h | 1 cu yd | 1,250 lb | 111.0 lb | 183.5 cm x 85.1 cm x 111.1 cm | 0.8 m³ | 567.0 kg | 50.3 kg | 1 |
| FG131600 | BLA | Tilt Truck, Heavy-Duty (RM) | 72.25" l x 33.5" w x 43.75" h | 1 cu yd | 2,100 lb | 120.0 lb | 183.5 cm x 85.1 cm x 111.1 cm | 0.8 m³ | 952.5 kg | 54.4 kg | 1 |
| FG131700* | BLA | Lid for 1 Cubic Yard Tilt Trucks | 69.5" l x 34" w x 8.5" h | N/A | N/A | 24.0 lb | 176.5 cm x 86.4 cm x 21.6 cm | N/A | N/A | 10.9 kg | 1 |

1 ½-Cubic-Yard Tilt Trucks

| NO. | COLOR | DESCRIPTION | U.S. DIMENSIONS | U.S. SIZE | U.S. CAPACITY | U.S. SHIP WT/CTN | METRIC DIMENSIONS | METRIC SIZE | METRIC CAPACITY | METRIC SHIP WT/CTN | PACK |
|-----------|-------|-----------------------------------|---------------------------|-----------|---------------|------------------|--------------------------------|-------------|-----------------|--------------------|------|
| FG102500* | BLA | Tilt Truck, Standard-Duty (RM) | 80.5" l x 43" w x 49.5" h | 1½ cu yd | 1,200 lb | 212.0 lb | 204.5 cm x 109.2 cm x 125.7 cm | 1.1 m³ | 544.3 kg | 96.2 kg | 1 |
| FG102600* | BLA | Tilt Truck, Heavy-Duty (RM) | 80.5" l x 43" w x 49.5" h | 1½ cu yd | 2,100 lb | 213.0 lb | 204.5 cm x 109.2 cm x 125.7 cm | 1.1 m³ | 952.5 kg | 96.6 kg | 1 |
| FG102700 | BLA | Lid for 1½ Cubic Yard Tilt Trucks | 82.9" l x 44.5" w x 3" h | N/A | N/A | 32.8 lb | 210.5 cm x 113 cm x 7.6 cm | N/A | N/A | 11.5 kg | 1 |

2-Cubic-Yard Tilt Trucks

| NO. | COLOR | DESCRIPTION | U.S. DIMENSIONS | U.S. SIZE | U.S. CAPACITY | U.S. SHIP WT/CTN | METRIC DIMENSIONS | METRIC SIZE | METRIC CAPACITY | METRIC SHIP WT/CTN | PACK |
|-----------|-------|--------------------------------|-----------------------------|-----------|---------------|------------------|------------------------------|-------------|-----------------|--------------------|------|
| FG103500* | BLA | Tilt Truck, Standard-Duty (RM) | 81.25" l x 46.75" w x 50" h | 2 cu yd | 1,900 lb | 215.0 lb | 206.4 cm x 118.7 cm x 127 cm | 1.5 m³ | 861.8 kg | 97.5 kg | 1 |
| FG103600* | BLA | Tilt Truck, Heavy-Duty (RM) | 81.25" l x 46.75" w x 50" h | 2 cu yd | 2,300 lb | 238.5 lb | 206.4 cm x 118.7 cm x 127 cm | 1.5 m³ | 1043.3 kg | 108.2 kg | 1 |

2 ½-Cubic-Yard Tilt Trucks

| NO. | COLOR | DESCRIPTION | U.S. DIMENSIONS | U.S. SIZE | U.S. CAPACITY | U.S. SHIP WT/CTN | METRIC DIMENSIONS | METRIC SIZE | METRIC CAPACITY | METRIC SHIP WT/CTN | PACK |
|-----------|-------|--------------------------------|---------------------------|-----------|---------------|------------------|--------------------------|-------------|-----------------|--------------------|------|
| FG104500* | BLA | Tilt Truck, Standard-Duty (RM) | 81.5" l x 55.5" w x 50" h | 2½ cu yd | 1,900 lb | 233.5 lb | 207 cm x 141 cm x 127 cm | 1.9 m³ | 861.8 kg | 105.9 kg | 1 |
| FG104600* | BLA | Tilt Truck, Heavy-Duty (RM) | 81.5" l x 55.5" w x 50" h | 2½ cu yd | 2,300 lb | 231.4 lb | 207 cm x 141 cm x 127 cm | 1.9 m³ | 1043.3 kg | 105.0 kg | 1 |

*Requires up to 3 weeks lead time and is not returnable.

*Custom colors available; contact Rubbermaid Customer Service for details.

*Pneumatic Wheels RM = Rotational Molded



Heavy-Duty Tilt Trucks

Towable and trainable tilt trucks for heavy-duty use.

- Heavy-duty tow bar, hitch, and frame for multiple truck towing and training up to 5MPH
- Pneumatic wheels provide smooth movement over rough terrain
- Available in 1/2, 1, and 1 1/2 cu yd sizes



FG131641
Towable/Trainable
Tilt Truck



FG131542BLA

1/2-Cubic-Yard Tilt Trucks

| NO. | COLOR | DESCRIPTION | U.S. DIMENSIONS | U.S. SIZE | U.S. CAPACITY | U.S. SHIP WT/CTN | METRIC DIMENSIONS | METRIC SIZE | METRIC CAPACITY | METRIC SHIP WT/CTN | PACK |
|-----------|-------|---|----------------------------|-----------|---------------|------------------|-------------------------------|--------------------|-----------------|--------------------|------|
| FG130641* | BLA | Towable Trainable Tilt Truck, Heavy-Duty (RM) | 64" l x 29" w x 40" h | 1/2 cu yd | 1,400 lb | 92.2 lb | 162.6 cm x 73.7 cm x 101.6 cm | 0.4 m ³ | 635.0 kg | 41.8 kg | 1 |
| FG130542 | BLA | Forkliftable Tilt Truck, Standard Duty (RM) | 60.5" l x 28" w x 38.63" h | 1/2 cu yd | 850 lb | 77.0 lb | 153.7 cm x 71.1 cm x 98.1 cm | 0.4 m ³ | 385.6 kg | 34.9 kg | 1 |

1-Cubic-Yard Tilt Trucks

| NO. | COLOR | DESCRIPTION | U.S. DIMENSIONS | U.S. SIZE | U.S. CAPACITY | U.S. SHIP WT/CTN | METRIC DIMENSIONS | METRIC SIZE | METRIC CAPACITY | METRIC SHIP WT/CTN | PACK |
|-----------|-------|---|-------------------------------|-----------|---------------|------------------|-------------------------------|--------------------|-----------------|--------------------|------|
| FG131641* | BLA | Towable Trainable Tilt Truck, Heavy-Duty (RM) | 72.5" l x 33.5" w x 42.25" h | 1 cu yd | 2,100 lb | 178.0 lb | 184.2 cm x 85.1 cm x 107.3 cm | 0.8 m ³ | 952.6 kg | 80.7 kg | 1 |
| FG131542 | BLA | Forkliftable Tilt Truck, Standard Duty (RM) | 72.25" l x 33.5" w x 43.75" h | 1 cu yd | 1,250 lb | 124.0 lb | 183.5 cm x 85.1 cm x 111.1 cm | 0.8 m ³ | 567.0 kg | 56.2 kg | 1 |

1 1/2-Cubic-Yard Tilt Trucks

| NO. | COLOR | DESCRIPTION | U.S. DIMENSIONS | U.S. SIZE | U.S. CAPACITY | U.S. SHIP WT/CTN | METRIC DIMENSIONS | METRIC SIZE | METRIC CAPACITY | METRIC SHIP WT/CTN | PACK |
|-----------|-------|---|---------------------------|-------------|---------------|------------------|-----------------------------------|---------------------|-----------------|--------------------|------|
| FG102641* | BLA | Towable Trainable Tilt Truck, Heavy-Duty (RM) | 92" l x 44" w x 51" h | 1 1/2 cu yd | 2,100 lb | 232.0 lb | 233.68 cm x 111.76 cm x 129.54 cm | 1.14 m ³ | 952.6 kg | 105.3 kg | 1 |
| FG102542 | BLA | Forkliftable Tilt Truck, Standard-Duty (RM) | 80.5" l x 43" w x 49.5" h | 1 1/2 cu yd | 1,500 lb | 211.9 lb | 204.47 cm x 109.22 cm x 125.73 | 1.14 m ³ | 680.3 kg | 96.11 kg | 1 |

*Pneumatic Wheels RM = Rotational Molded

Heavy-Duty Tilt Truck Lids

Domed, hinged lids provide convenient access to contents without reducing overall capacity.



FG102700

Heavy-Duty Tilt Truck Lids

| NO. | COLOR | DESCRIPTION | U.S. DIMENSIONS | U.S. SIZE | U.S. CAPACITY | U.S. SHIP WT/CTN | METRIC DIMENSIONS | METRIC SIZE | METRIC CAPACITY | METRIC SHIP WT/CTN | PACK |
|----------|-------|--------------------------------------|---------------------------|-----------|---------------|------------------|------------------------------|-------------|-----------------|--------------------|------|
| FG130700 | BLA | Lid for 1/2-Cubic-Yard Tilt Trucks | 56.5" l x 28.5" w x 9" h | N/A | N/A | 22.3 lb | 143.5 cm x 72.4 cm x 22.9 cm | N/A | N/A | 10.1 kg | 1 |
| FG131700 | BLA | Lid for 1-Cubic-Yard Tilt Trucks | 69.5" l x 34" w x 8.5" h | N/A | N/A | 24.0 lb | 176.5 cm x 86.4 cm x 21.6 cm | N/A | N/A | 10.9 kg | 1 |
| FG102700 | BLA | Lid for 1 1/2-Cubic-Yard Tilt Trucks | 82.88" l x 44.5" w x 3" h | N/A | N/A | 32.8 lb | 210.5 cm x 113 cm x 7.6 cm | N/A | N/A | 14.9 kg | 1 |

Self-Dumping Hoppers

Large-capacity hoppers store and dump heavy loads with ease.

- Forklift-compatible for elevated dumping
- Tilts a full 30° below horizontal to ensure complete dumping
- Pull-release safety latch on .5- and 1-Cubic-Yard Hoppers and rotating latch release on 1.5- and 2-Cubic-Yard Hoppers prohibits premature dumping
- Resists rusting, denting, and pitting that can affect metal hoppers



½-Cubic-Yard Hoppers

| NO. | COLOR | DESCRIPTION | U.S. DIMENSIONS | U.S. SIZE | U.S. CAPACITY | U.S. SHIP WT/CTN | METRIC DIMENSIONS | METRIC SIZE | METRIC CAPACITY | METRIC SHIP WT/CTN | PACK |
|----------|-------|---|-----------------------------|-----------|---------------|------------------|-----------------------------|-------------|-----------------|--------------------|------|
| FG105443 | BLA | Self-Dumping Hopper with four 6" dia (15.2 cm) Polyolefin Casters | 55" l x 26.25" w x 47.63" h | ½ cu yd | 750 lb | 212.0 lb | 139.7 cm x 66.7 cm x 121 cm | .4 m³ | 340.2 kg | 96.2 kg | 1 |

1-Cubic-Yard Hoppers

| NO. | COLOR | DESCRIPTION | U.S. DIMENSIONS | U.S. SIZE | U.S. CAPACITY | U.S. SHIP WT/CTN | METRIC DIMENSIONS | METRIC SIZE | METRIC CAPACITY | METRIC SHIP WT/CTN | PACK |
|----------|-------|---|------------------------------|-----------|---------------|------------------|-------------------------------|-------------|-----------------|--------------------|------|
| FG105943 | BLA | Self-Dumping Hopper with four 6" dia (15.2 cm) Polyolefin Casters | 71.5" l x 31.25" w x 52.5" h | 1 cu yd | 1,000 lb | 247.0 lb | 181.6 cm x 79.4 cm x 133.4 cm | .8 m³ | 453.6 kg | 112.0 kg | 1 |

2½-Cubic-Yard Hoppers

| NO. | COLOR | DESCRIPTION | U.S. DIMENSIONS | U.S. SIZE | U.S. CAPACITY | U.S. SHIP WT/CTN | METRIC DIMENSIONS | METRIC SIZE | METRIC CAPACITY | METRIC SHIP WT/CTN | PACK |
|-----------------------|-------|---|----------------------------|-----------|---------------|------------------|--------------------------------|-------------|-----------------|--------------------|------|
| FG107443 ^A | BLA | Self-Dumping Hopper with four 6" dia (15.2 cm) Polyolefin Casters | 83.5" l x 55" w x 56.63" h | 2½ cu yd | 1,000 lb | 376.0 lb | 212.1 cm x 139.7 cm x 143.8 cm | 1.9 m³ | 453.6 kg | 170.5 kg | 1 |

^ARequires 3-week lead time and is not returnable.

Mega BRUTE® Mobile Collectors

The Mega BRUTE® Mobile Collector is a highly maneuverable and versatile waste and linen collection and sortation system. Innovative design delivers improved productivity and ease of use.

- High capacity—120-gallon/400-pound capacity
- Sortation options support recycling efforts
- Highly maneuverable; fits through a standard 36" doorway and travels easily on and off most elevators
- Rear doors ease handling of heavy filled liners



Optional lid (FG9W7200) fully covers contents; center hinge allows access to either end of Mega BRUTE® Mobile Collector.



Can liner retainer secures a 55-gallon can liner and flips up for easy access to storage area.



FG9W7300



SORTATION OPTIONS
Holds an optional 23-gallon Slim Jim® container for improved waste sortation and recycling.

EASILY MANEUVERABLE
Large 12" wheels and 5" nonmarking lockable casters in a diamond pattern allow Mega BRUTE® Mobile Collector to turn on its own axis.

STORAGE AREA
Ideal for storing extra can liners and other cleaning supplies.

| NO. | COLOR | DESCRIPTION | U.S. DIMENSIONS | U.S. CAPACITY | U.S. SHIP WT/CTN | METRIC DIMENSIONS | METRIC CAPACITY | METRIC SHIP WT/CTN | PACK |
|----------|-------|---|-----------------------------|---------------|------------------|------------------------------|-----------------|--------------------|------|
| FG9W7300 | BLA | Executive Mega BRUTE® Mobile Collector – 1-Pack | 52.5" l x 27.5" w x 42.5" h | 120 gal | 74.0 lb | 133.4 cm x 69.9 cm x 108 cm | 454.3 L | 33.6 kg | 1 |
| FG9W7200 | BLA | Executive Mega BRUTE® Mobile Collector Lid | 49.5" l x 30" w x 10.5" h | N/A | 12.4 lb | 125.7 cm x 76.2 cm x 26.7 cm | N/A | 5.6 kg | 1 |

Cube Trucks

A complete line of trucks for waste collection, material transport, and laundry handling, with the durability of Rotational Molding technology.

- Towable trainable model offers corner casters
- Spring platform option elevates contents for easier loading and unloading
- Heavy-duty utility models include metal body support band



FG461200 / FG461300

8-Cubic-Foot (6.4 Bushel)

| NO. | COLOR | DESCRIPTION | U.S. DIMENSIONS | U.S. BUSHEL (BU) | U.S. SIZE | U.S. CAPACITY | U.S. SHIP WT/CTN | METRIC DIMENSIONS | METRIC SIZE | METRIC CAPACITY | METRIC SHIP WT/CTN | PACK |
|-----------------------|-------|---|------------------------------|------------------|-----------|---------------|------------------|-----------------------------|-------------------|-----------------|--------------------|------|
| FG460800 | BLA | Cube Truck | 38" l x 26" w x 28.13" h | 6.4 | 8 cu ft | 300 lb | 36.0 lb | 96.5 cm x 66 cm x 71.5 cm | .2 m ³ | 136.1 kg | 16.3 kg | 1 |
| FG470800 | BLA | Utility Truck, Heavy-Duty with 4" dia (10.2 cm) Casters | 38.38" l x 26" w x 28.25" h | 6.4 | 8 cu ft | 700 lb | 48.0 lb | 97.5 cm x 66 cm x 71.8 cm | .2 m ³ | 317.5 kg | 21.8 kg | 1 |
| FG460900 ^a | BLA | Lid for 8 ft. ³ Cube Trucks | 38.38" l x 25.75" w x 8.5" h | N/A | N/A | N/A | 13.5 lb | 97.5 cm x 65.4 cm x 21.6 cm | N/A | N/A | 6.1 kg | 1 |

12-Cubic-Foot (9.6 Bushel)

| NO. | COLOR | DESCRIPTION | U.S. DIMENSIONS | U.S. BUSHEL (BU) | U.S. SIZE | U.S. CAPACITY | U.S. SHIP WT/CTN | METRIC DIMENSIONS | METRIC SIZE | METRIC CAPACITY | METRIC SHIP WT/CTN | PACK |
|-----------------------|------------|---|-----------------------------|------------------|-----------|---------------|------------------|------------------------------|-------------------|-----------------|--------------------|------|
| FG461200 | DBLUE, BLA | Cube Truck | 42.75" l x 28" w x 33" h | 9.6 | 12 cu ft | 400 lb | 40.0 lb | 108.6 cm x 71.1 cm x 83.8 cm | .3 m ³ | 181.4 kg | 18.1 kg | 1 |
| 1867538 | BLACK | Executive Cube Truck w/ Quiet Casters | 42.75" l x 28" w x 33" h | 9.6 | 12 cu ft | 400 lb | 40.0 lb | 108.6 cm x 71.1 cm x 83.8 cm | .3 m ³ | 181.4 kg | 18.1 kg | 1 |
| FG471200 | BLA | Utility Truck, Heavy-Duty with 4" dia (10.2 cm) Casters | 43.25" l x 28" w x 33.88" h | 9.6 | 12 cu ft | 800 lb | 62.3 lb | 109.9 cm x 71.1 cm x 86.1 cm | .3 m ³ | 362.9 kg | 28.3 kg | 1 |
| FG461300 ^a | BLA | Lid for 12 ft. ³ Cube Trucks | 43.13" l x 27.5" w x 8.5" h | N/A | N/A | N/A | 15.1 lb | 109.6 cm x 69.9 cm x 21.6 cm | N/A | N/A | 6.8 kg | 1 |

14-Cubic-Foot (11.3 Bushel)

| NO. | COLOR | DESCRIPTION | U.S. DIMENSIONS | U.S. BUSHEL (BU) | U.S. SIZE | U.S. CAPACITY | U.S. SHIP WT/CTN | METRIC DIMENSIONS | METRIC SIZE | METRIC CAPACITY | METRIC SHIP WT/CTN | PACK |
|-----------------------|-------|---|----------------------------|------------------|-----------|---------------|------------------|------------------------------|-------------------|-----------------|--------------------|------|
| FG461100 | BLA | Spring Platform Truck | 44.13" l x 31" w x 32.5" h | 11.3 | 14 cu ft | 500 lb | 60.0 lb | 112.1 cm x 78.7 cm x 82.6 cm | .4 m ³ | 226.8 kg | 27.2 kg | 1 |
| FG461400 | BLA | Cube Truck | 44.13" l x 31" w x 32.5" h | 11.3 | 14 cu ft | 500 lb | 47.0 lb | 112.1 cm x 78.7 cm x 82.6 cm | .4 m ³ | 226.8 kg | 21.3 kg | 1 |
| FG461500 ^a | BLA | Lid for 14 ft. ³ Cube Trucks | 44.13" l x 31" w x 8.5" h | N/A | N/A | N/A | 17.2 lb | 112.1 cm x 78.7 cm x 21.6 cm | N/A | N/A | 7.8 kg | 1 |

16-Cubic-Foot (12.9 Bushel)

| NO. | COLOR | DESCRIPTION | U.S. DIMENSIONS | U.S. BUSHEL (BU) | U.S. SIZE | U.S. CAPACITY | U.S. SHIP WT/CTN | METRIC DIMENSIONS | METRIC SIZE | METRIC CAPACITY | METRIC SHIP WT/CTN | PACK |
|-----------------------|-------|---|-----------------------------|------------------|-----------|---------------|------------------|------------------------------|-------------------|-----------------|--------------------|------|
| FG461600 | BLA | Cube Truck | 43.75" l x 31" w x 37" h | 12.9 | 16 cu ft | 500 lb | 51.0 lb | 111.1 cm x 78.7 cm x 94 cm | .5 m ³ | 226.8 kg | 23.1 kg | 1 |
| FG461673 | BLUE | Recycling Cube Truck | 43.75" l x 31" w x 37" h | 12.9 | 16 cu ft | 500 lb | 51.0 lb | 111.1 cm x 78.7 cm x 94 cm | .5 m ³ | 226.8 kg | 23.1 kg | 1 |
| 1867537 | BLACK | Executive Cube Truck w/ Quiet Casters | 43.75" l x 31" w x 37" h | 12.9 | 16 cu ft | 500 lb | 51.0 lb | 111.1 cm x 78.7 cm x 94 cm | .5 m ³ | 226.8 kg | 23.1 kg | 1 |
| FG471600 | BLA | Utility Truck, Heavy-Duty with 5" dia (12.7 cm) Casters | 44.38" l x 31" w x 38.25" h | 12.9 | 16 cu ft | 1,000 lb | 74.3 lb | 112.7 cm x 78.7 cm x 97.2 cm | .5 m ³ | 453.6 kg | 33.7 kg | 1 |
| FG461500 ^a | BLA | Lid for 16 ft. ³ Cube Trucks | 44.13" l x 31" w x 8.5" h | N/A | N/A | N/A | 17.2 lb | 112.1 cm x 78.7 cm x 21.6 cm | N/A | N/A | 7.8 kg | 1 |

20-Cubic-Foot (16.1 Bushel)

| NO. | COLOR | DESCRIPTION | U.S. DIMENSIONS | U.S. BUSHEL (BU) | U.S. SIZE | U.S. CAPACITY | U.S. SHIP WT/CTN | METRIC DIMENSIONS | METRIC SIZE | METRIC CAPACITY | METRIC SHIP WT/CTN | PACK |
|-----------------------|-------|---|------------------------------|------------------|-----------|---------------|------------------|------------------------------|-------------------|-----------------|--------------------|------|
| FG461900 | BLA | Cube Truck | 48" l x 34.1" w x 36.5" h | 16.1 | 20 cu ft | 600 lb | 60.0 lb | 121.9 cm x 86.7 cm x 92.7 cm | .6 m ³ | 272.2 kg | 27.2 kg | 1 |
| FG461800 | BLA | Spring Platform Truck | 48" l x 34.1" w x 36.5" h | 16.1 | 20 cu ft | 600 lb | 75.0 lb | 121.9 cm x 86.7 cm x 92.7 cm | .6 m ³ | 272.2 kg | 34.0 kg | 1 |
| FG472000 | BLA | Utility Truck, Heavy-Duty with 5" dia (12.7 cm) Casters | 48.25" l x 34.1" w x 37.9" h | 16.1 | 20 cu ft | 1,200 lb | 84.8 lb | 122.6 cm x 86.7 cm x 96.2 cm | .6 m ³ | 544.3 kg | 38.5 kg | 1 |
| FG461700 ^a | BLA | Lid for 20 ft. ³ Cube Trucks | 48.5" l x 34" w x 8.5" h | N/A | N/A | N/A | 18.8 lb | 123.2 cm x 86.4 cm x 21.6 cm | N/A | N/A | 8.5 kg | 1 |

27-Cubic-Foot (21.7 Bushel)

| NO. | COLOR | DESCRIPTION | U.S. DIMENSIONS | U.S. BUSHEL (BU) | U.S. SIZE | U.S. CAPACITY | U.S. SHIP WT/CTN | METRIC DIMENSIONS | METRIC SIZE | METRIC CAPACITY | METRIC SHIP WT/CTN | PACK |
|-----------|-------|--|---------------------------|------------------|-----------|---------------|------------------|-------------------------------|-------------------|-----------------|--------------------|------|
| FG472700 | BLA | Utility Truck, Heavy-Duty with 5" dia (12.7 cm) Corner Casters | 59" l x 34" w x 42.9" h | 21.7 | 27 cu ft | 1,200 lb | 105.0 lb | 149.9 cm x 86.4 cm x 108.9 cm | .8 m ³ | 544.3 kg | 47.6 kg | 1 |
| FG472741* | BLA | Towable Utility Truck, Heavy-Duty | 59" l x 34" w x 42.9" h | 21.7 | 27 cu ft | 1,200 lb | 120.0 lb | 149.9 cm x 86.4 cm x 108.9 cm | .8 m ³ | 544.3 kg | 54.4 kg | 1 |
| FG472600 | BLA | Lid for 27 ft. ³ Cube Trucks | 59.88" l x 34.5" w x 5" h | N/A | N/A | N/A | 19.9 lb | 152.1 cm x 87.6 cm x 12.7 cm | N/A | N/A | 9.0 kg | 1 |

Replacement Spring Kit

| NO. | COLOR | DESCRIPTION | U.S. DIMENSIONS | U.S. BUSHEL (BU) | U.S. SIZE | U.S. CAPACITY | U.S. SHIP WT/CTN | METRIC DIMENSIONS | METRIC SIZE | METRIC CAPACITY | METRIC SHIP WT/CTN | PACK |
|----------|-------|--|----------------------------|------------------|-----------|---------------|------------------|-------------------|-------------|-----------------|--------------------|------|
| FG461000 | 0000 | Spring Kit for FG461100, FG461400 Trucks | 34.2" l x 21.2" w x 0.5" h | N/A | N/A | N/A | 12.0 lb | N/A | N/A | N/A | 5.4 kg | 1 |

*Requires 2-week lead time and is not returnable.
*Custom colors available; contact Customer Service for details.

UTILITY REFUSE AND RECYCLING

DECORATIVE REFUSE

CLEANING

MATERIAL HANDLING

WASHROOM

FOODSERVICE

ACCESSORIES & INDEX

Collapsible X-Carts

Durable, easy-to-maneuver cart efficiently transports large, bulky loads, then conveniently collapses to minimize storage footprint.

- Compact, collapsible frame enables efficient storage
- Durable vinyl bag accommodates bulky loads
- Easy-to-clean, detachable bag
- Color-coded ribbons classify transport materials to prevent cross-contamination
- Aesthetically pleasing black finish disguises stains and dirt
- High-quality TPR casters provide quiet operation
- Bumper guards help prevent damage to cart and facility during transport

1881781

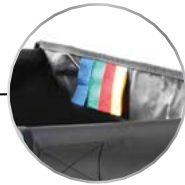

COLOR-CODED TABS

Organize your linen and/or waste collection. Select the color you wish to assign for the job and simply trim off the other three tabs.



PREMIUM QUIET CASTERS

Castors swivel for superior maneuverability, while bumper guards add extra protection during transport.

Compact, collapsible frame reduces width by 75% to enable efficient storage.



DURABLE CONSTRUCTION

Robust stainless steel with powder-coated finish will not warp or rust.

1881750



Six storage pockets hold cleaning tools, gloves, clothes, spray bottles, cleaning chemicals & more!



| NO. | COLOR | DESCRIPTION | U.S. DIMENSIONS | U.S. BUSHELS | U.S. SIZE | U.S. CAPACITY | U.S. SHIP WT/CTN | METRIC DIMENSIONS | METRIC SIZE | METRIC CAPACITY | METRIC SHIP WT/CTN | PACK |
|---------|-------|---|------------------------------|--------------|-----------|---------------|------------------|------------------------------------|---------------------|-----------------|--------------------|------|
| 1881749 | BLACK | Collapsible X-Cart, 4 Bushels | 24.1" l x 20.3" w x 34" h | 4 | 5 | 220 lb | 20.6 lb | 61.2 cm x 51.6 cm x 86.4 cm | 0.14 m ³ | 99.8 kg | 9.3 kg | 1 |
| 1881750 | BLACK | Collapsible X-Cart, 8 Bushels | 35.7" l x 24.1" w x 34" h | 8 | 10 | 220 lb | 27.0 lb | 95.3 cm x 61.2 cm x 86.4 cm | 0.28 m ³ | 99.8 kg | 12.2 kg | 1 |
| 1881781 | BLACK | Collapsible Multi-Stream X-Cart (2 x 4 Bushels) | 35.7" l x 24.1" w x 34" h | 8 | 10 | 220 lb | 28.6 lb | 95.3 cm x 61.2 cm x 86.4 cm | 0.28 m ³ | 99.8 kg | 13.0 kg | 1 |
| 1881782 | BLACK | Collapsible X-Cart Replacement Bag, 4 Bushels | 15.3" l x 22.4" w x 27.3" h | 4 | 5 | 220 lb | 4.46 lb | 38.9 cm x 56.9 cm x 69.3 cm | 0.14 m ³ | 99.8 kg | 2.0 kg | 2 |
| 1881783 | BLACK | Collapsible X-Cart Replacement Bag, 8 Bushels | 30.5" l x 22.4" w x 27.3" h | 8 | 10 | 220 lb | 6.1 lb | 77.5 cm x 56.9 cm x 69.3 cm | 0.28 m ³ | 99.8 kg | 2.8 kg | 2 |
| 1889863 | BLACK | Collapsible X-Cart Cover, Small (for 1881749) | 25.38" l x 19.88" w x 9.0" h | | | | 0.85 kg | 25.38 cm l x 19.88 cm w x 9.0 cm h | 0.85 kg | | | 1 |
| 1889864 | BLACK | Collapsible X-Cart Cover, Large (for 1881750 and 1881781) | 35.0" l x 26.25" w x 9.0" h | | | 1.17 kg | 2.59 lbs. | 35.0 cm l x 26.25 cm w x 9.0 cm h | 1.17 kg | | | 1 |

UTILITY REFUSE AND RECYCLING

DECORATIVE REFUSE

CLEANING

MATERIAL HANDLING

WASHROOM

FOODSERVICE

ACCESSORIES & INDEX



UTILITY REFUSE AND RECYCLING

DECORATIVE REFUSE

CLEANING

MATERIAL HANDLING

WASHROOM

FOODSERVICE

ACCESSORIES & INDEX



Integrated slotted v-notches for safe cutting



Ergonomic handle improves control and worker safety



Durable construction and large capacities to handle big loads



Versatile solutions for back- and front-of-house tasks

MOVE LOADS SAFELY AND EFFICIENTLY

The variable grip-height handle on our carts and trucks improves maneuverability and reduces muscle strain for most every user, regardless of height.



TRADITIONAL CART HANDLE DESIGN

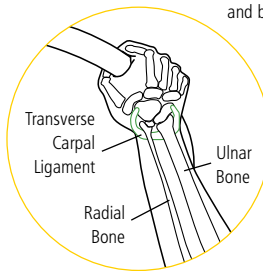

Angled handle helps keep wrist and bones in forearm aligned for optimum leverage while turning.

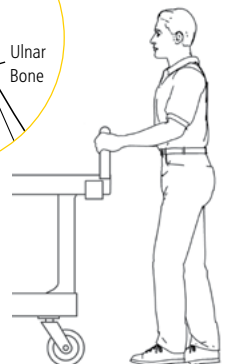

IMPROVED VARIABLE GRIP-HEIGHT HANDLE

Heavy-Duty Adaptable Carts

The Heavy-Duty Adaptable Cart provides superior versatility for tackling whatever task is at hand. It reduces the need for time-consuming user modifications with a variety of integrated features including: an ergonomic adjustable handle with four positions for maximum comfort, a flip-up shelf, locking casters, and numerous storage features designed to help organize tools and small parts.

- Four pack of snap-in hooks frees up cart shelf space and keeps extension cords and tools within reach, with numerous placement locations along the rim of RCP Heavy Duty Adaptable Carts. Compatible with RCP SKUs 1997206 and 1997208.
- Extended base attaches to RCP's Medium Heavy Duty Adaptable Carts to carry tall objects like 6' ladders or 4' light bulbs. Compatible with RCP SKUs 1997208 and 1997209.
- Two fixed and two swivel locking casters included. Compatible with RCP Heavy Duty Adaptable Carts (1997206, 1997207, 1997208, 1997209)



1997208



PACK OF 4
ACCESSORY HOOKS



OPTIONAL EXTENSION
DRAWER

Can be added under the top shelf for additional storage of small parts and tools.



EXTENDED BASE

Can be added to the medium cart for carrying tall objects such as a ladder or box of 4' light bulbs.



| NO. | COLOR | DESCRIPTION | U.S. DIMENSIONS | U.S. CAPACITY | U.S. SHIP WT/CTN | METRIC DIMENSIONS | METRIC CAPACITY | METRIC SHIP WT/CTN | CASTER TYPE | PACK |
|--------------|-------|-------------------------------------|--------------------------------|---------------|------------------|---------------------------------|-----------------|--------------------|--------------|------|
| 1997206 | Black | Small Heavy-Duty Adaptable Cart | 46.2" l x 17.75" w x 36.0" h | 500 lb | 37.20 lb | 117.3 cm x 45.09 cm x 91.40 cm | 226.8 kg | 16.87 kg | 5" TPR | 1 |
| 1997208 | Black | Medium Heavy-Duty Adaptable Cart | 51.47" l x 25.20" w x 36.0" h | 500 lb | 49.0 lb | 130.73 cm x 64.01 cm x 91.44 cm | 226.8 kg | 22.23 kg | 5" TPR | 1 |
| 1997227 | Red | Pack of 4 Accessory Hooks | 2.12" l x 3.54" w x 3.89" h | 10 lb | 0.70 lb | 5.39 cm x 9 cm x 9.89 cm | 4.54 kg | 0.32 kg | N/A | 4 |
| 1997230 | Black | Medium Extended Base | 25.35" l x 11.66" w x 6.50" h | 40 lb | 6.0 lb | 64.39 cm x 29.62 cm x 16.51 cm | 18.14 kg | 2.72 kg | N/A | 1 |
| FG459300 | Red | Extension Drawer | 17.0" l x 25.0" w x 4.7" h | N/A | 12.28 lb | 43.18 cm x 63.50 cm x 11.94 cm | N/A | 5.57 kg | N/A | 1 |
| 1997371 | Black | 5" Replacement Caster Set (Locking) | 5.69" l x 2.56" w x 5.82" h | N/A | 4.60 lb | 14.45 cm x 6.50 cm x 14.78 cm | N/A | 2.09 kg | 5" TPR | 4 |
| FG4592000000 | Black | 8" Replacement Caster Set | 18.82" l x 12.57" w x 10.39" h | N/A | 25.55 lb | 47.8 cm x 31.93 cm x 26.39 cm | N/A | 11.59 kg | 8" Pneumatic | 1 |

UTILITY REFUSE
AND RECYCLING

DECORATIVE REFUSE

CLEANING

MATERIAL HANDLING

WASHROOM

FOODSERVICE

ACCESSORIES
& INDEX

Heavy-Duty Utility Carts

Transport materials, supplies, and heavy loads securely in almost any environment.

- Available in lipped-shelf or flat-shelf models
- Ergonomic version comes with premium handle that optimizes hand placement

Lipped-Shelf models feature:

- Integrated V-notch to hold pipe and conduit securely for safe cutting
- Deep pocket shelves to keep loads secure

Flat-shelf models feature:

- Large, flat top shelf for oversized loads and smarter work surface
- Lower pocket shelf to keep loads secure



FG452089



FG452088



1997208



STAY ORGANIZED
Easy-reach tool/accessory hooks provide additional storage.



WORK MORE EFFICIENTLY
Built-in tool holster and caddy keep items at hand and in place during transport.



CUSTOMIZABLE
Molded-in fittings allow you to add pipe or rods to hold wire spools and other roll-type goods.

CART SIZES:

- 17 1/2" X 38 1/2"
- 25 1/4" X 44"
- 25 1/4" X 54"

CAPACITY RANGE (lbs)
500-750

UTILITY REFUSE AND RECYCLING

DECORATIVE REFUSE

CLEANING

MATERIAL HANDLING

WASHROOM

FOODSERVICE

ACCESSORIES & INDEX



FG452089

KEEP LOADS SECURE
Deep pocket shelves keep contents in place.



FG452089

STRUCTURAL FOAM CONSTRUCTION
Durable structural foam construction won't leak, rust, chip, dent, or peel.

Lipped-Shelf Carts

| NO. | COLOR | DESCRIPTION | U.S. DIMENSIONS | U.S. CAPACITY | U.S. SHIP WT/CTN | METRIC DIMENSIONS | METRIC CAPACITY | METRIC SHIP WT/CTN | CASTER TYPE | PACK |
|-----------|-----------|---|--------------------------------|---------------|------------------|------------------------------|-----------------|--------------------|--------------|------|
| FG450088 | BLA, BEIG | Ergo Handle Utility Cart (Small) | 39" l x 17.88" w x 33.25" h | 500 lb | 30.8 lb | 99.1 cm x 45.4 cm x 84.5 cm | 226.8 kg | 14.0 kg | 5" TPR | 1 |
| FG452088 | BLA, BEIG | Ergo Handle Utility Cart (Med) | 44" l x 25.25" w x 39" h | 500 lb | 42.8 lb | 111.8 cm x 64.1 cm x 99.1 cm | 226.8 kg | 19.4 kg | 5" TPR | 1 |
| FG452010 | BLA | Ergo Handle Utility Cart (Med) with Pneumatic Casters | 45.25" l x 25.88" w x 37.12" h | 500 lb | 63.0 lb | 114.9 cm x 65.7 cm x 94.3 cm | 226.8 kg | 28.6 kg | 8" Pneumatic | 1 |
| FG454600 | BLA | Ergo Handle Utility Cart (Large) | 55" l x 26" w x 33.25" h | 750 lb | 52.4 lb | 139.7 cm x 66 cm x 84.5 cm | 340.2 kg | 23.8 kg | 5" TPR | 1 |
| FG454610 | BLA | Ergo Handle Utility Cart (Large) with Pneumatic Casters | 55" l x 26" w x 33.25" h | 750 lb | 71.0 lb | 139.7 cm x 66 cm x 84.5 cm | 340.2 kg | 32.2 kg | 8" Pneumatic | 1 |
| FG450089 | BLA, BEIG | Flat Handle Utility Cart (Small) | 39" l x 17.88" w x 33.25" h | 500 lb | 31.1 lb | 99.1 cm x 45.4 cm x 84.5 cm | 226.8 kg | 14.1 kg | 5" TPR | 1 |
| FG452089 | BLA, BEIG | Flat Handle Utility Cart (Med) | 45.25" l x 25.88" w x 33.25" h | 500 lb | 44.7 lb | 114.9 cm x 65.7 cm x 84.5 cm | 226.8 kg | 20.3 kg | 5" TPR | 1 |
| FG9T6600* | BLA | Flat Handle Utility Cart (Small) with 5" Casters | 34.25" l x 17.375" w x 31.5" h | 500 lb | 30.8 lb | 87.0 cm x 44.1 cm x 80.0 cm | 226.8 kg | 14.0 kg | 5" (12.7 cm) | 12 |
| FG9T6700* | BLA | Flat Handle Utility Cart (Med) with 5" Casters | 40.25" l x 25.63" w x 32.5" h | 500 lb | 42.8 lb | 102.2 cm x 65.1 cm x 82.6 cm | 226.8 kg | 19.4 kg | 5" (12.7 cm) | 10 |

Flat-Shelf Carts

| NO. | COLOR | DESCRIPTION | U.S. DIMENSIONS | U.S. CAPACITY | U.S. SHIP WT/CTN | METRIC DIMENSIONS | METRIC CAPACITY | METRIC SHIP WT/CTN | CASTER TYPE | PACK |
|----------|-----------|----------------------------------|-------------------------------|---------------|------------------|------------------------------|-----------------|--------------------|-------------|------|
| FG450500 | BLA, BEIG | Ergo Handle Utility Cart (Small) | 37.88" l x 19.2" w x 33.3" h | 500 lb | 29.5 lb | 96.2 cm x 48.8 cm x 84.6 cm | 226.8 kg | 13.4 kg | 5" TPR | 1 |
| FG452500 | BLA, BEIG | Ergo Handle Utility Cart (Med) | 43.88" l x 25.88" w x 33.3" h | 500 lb | 41.0 lb | 111.5 cm x 65.7 cm x 84.6 cm | 226.8 kg | 18.6 kg | 5" TPR | 1 |
| FG454500 | BLA | Ergo Handle Utility Cart (Large) | 54" l x 25.25" w x 36" h | 750 lb | 52.4 lb | 137.2 cm x 64.1 cm x 91.4 cm | 340.2 kg | 23.8 kg | 5" TPR | 1 |
| FG450589 | BLA, BEIG | Flat Handle Utility Cart (Small) | 37.88" l x 19.2" w x 33.3" h | 500 lb | 29.5 lb | 96.2 cm x 48.8 cm x 84.6 cm | 226.8 kg | 13.4 kg | 5" TPR | 1 |
| FG452589 | BLA, BEIG | Flat Handle Utility Cart (Med) | 43.88" l x 25.88" w x 33.3" h | 500 lb | 41.0 lb | 111.5 cm x 65.7 cm x 84.6 cm | 226.8 kg | 18.6 kg | 5" TPR | 1 |

*Pallet Pack

ACCESSORIZE AND CUSTOMIZE FOR YOUR NEEDS



FG459000 3-OUTLET POWER STRIP



FG335388 8-GALLON REFUSE BIN



FG459300 SINGLE FULL EXTENSION DRAWER (see Cart Accessories)



UTILITY REFUSE AND RECYCLING

DECORATIVE REFUSE

CLEANING

MATERIAL HANDLING

WASHROOM

FOODSERVICE

ACCESSORIES & INDEX

Trades Carts

Moves productivity right to the worksite—a complete tool storage and mobile workbench system.

- Four compartmentalized boxes for storing assorted parts and hardware
- Fully enclosed, lockable storage compartment helps keep tools and materials secure (FG618088)
- Two storage bins hold essential hand tools and supplies
- Carts move easily over hard surfaces and through elevators and doorways
- Flat surface at user-friendly height provides convenient work area
- Nonmarking, 5" casters for easy mobility
- Optional Refuse Bin (FG335388) and Utility Bin (FG335488)



FG618088BLA

Convenient lockable cabinet



FG618088BLA

Four compartment drawers for assorted parts



FG618000BLA



FG618088BLA

| NO. | COLOR | DESCRIPTION | U.S. DIMENSIONS | U.S. CAPACITY | U.S. SHIP WT/CTN | METRIC DIMENSIONS | METRIC CAPACITY | METRIC SHIP WT/CTN | PACK |
|----------|------------|---|-----------------------------|---------------------------------------|------------------|-----------------------------|---------------------------------------|--------------------|------|
| FG618000 | BLA | Trades Cart with 5" (12.7 cm) Casters includes 2 parts boxes and 4 parts bins | 38" l x 19.25" w x 33.38" h | 180 lb top shelf, 150 lb bottom shelf | 50.3 lb | 96.5 cm x 48.9 cm x 84.8 cm | 81.6 kg top shelf, 68 kg bottom shelf | 22.8 kg | 1 |
| FG618088 | BLA | Trades Cart with Locking Cabinet includes 2 parts boxes and 4 parts bins | 38" l x 19.25" w x 33.38" h | 180 lb top shelf, 150 lb bottom shelf | 68.0 lb | 96.5 cm x 48.9 cm x 84.8 cm | 81.6 kg top shelf, 68 kg bottom shelf | 30.8 kg | 1 |

5-Drawer Mobile Work Center

Heavy-duty work surface supports up to 250 lbs.

- Built-in cord wrap provides neat, convenient storage of power tools and work lights
- Casters allow easy maneuverability and are lockable for safety
- Locking bar provides security and keeps drawers from sliding open during transport
- Pegboard side panels provide convenient tool organization



FG773488BLA



FG773488BLA

| NO. | COLOR | DESCRIPTION | U.S. DIMENSIONS | U.S. CAPACITY | U.S. SHIP WT/CTN | METRIC DIMENSIONS | METRIC CAPACITY | METRIC SHIP WT/CTN | PACK |
|----------|------------|-----------------------------|------------------------------|---------------|------------------|-----------------------------|-----------------|--------------------|------|
| FG773488 | BLA | 5-Drawer Mobile Work Center | 32.63" l x 19.9" w x 33.5" h | 250 lb | 69.0 lb | 82.9 cm x 50.5 cm x 85.1 cm | 113.4 kg | 31.3 kg | 1 |

UTILITY REFUSE AND RECYCLING

DECORATIVE REFUSE

CLEANING

MATERIAL HANDLING

WASHROOM

FOODSERVICE

ACCESSORIES & INDEX

TradeMaster® Mobile Cabinets and Work Centers

Easily transport tools and supplies where you need them.

- Features locking cabinet doors and 4" deep drawers for versatile tool and supply storage and organization
- Drawers feature commercial-quality, ball-bearing slides
- Metal-reinforced structural foam shelves engineered for durability
- Arrives 90% assembled



FG451288BLA



FG451388BLA



FG453388BLA

| NO. | COLOR | DESCRIPTION | U.S. DIMENSIONS | U.S. CAPACITY | U.S. SHIP WT/CTN | METRIC DIMENSIONS | METRIC CAPACITY | METRIC SHIP WT/CTN | PACK |
|----------|-------|---|--------------------------------|---------------|------------------|------------------------------|-----------------|--------------------|------|
| FG451288 | BLA | TradeMaster® Cart with 2-Door Cabinet, Small | 41.63" l x 18.25" w x 38.38" h | 500 lb | 57.1 lb | 105.7 cm x 46.4 cm x 97.5 cm | 226.8 kg | 25.9 kg | 1 |
| FG451388 | BLA | TradeMaster® Cart with 4 Drawers | 40.63" l x 18.38" w x 33.38" h | 500 lb | 86.9 lb | 103.2 cm x 46.7 cm x 84.8 cm | 226.8 kg | 39.4 kg | 1 |
| FG453388 | BLA | TradeMaster® Cart with 4 Drawers and Cabinet, Small | 49" l x 26.25" w x 38" h | 750 lb | 123.0 lb | 124.5 cm x 66.7 cm x 96.5 cm | 340.2 kg | 55.8 kg | 1 |

Convertible Utility Cart

Converts from a utility cart to a platform truck in just seconds.

- Innovative design
- Multifunctional productivity with improved worker well-being—saving you time and money



PUSH BUTTONS

Depress buttons to easily convert from utility cart to platform truck.



LOCKING CASTERS

Rear wheel locks keep cart safely in place while loading and unloading.



FOOT PEDAL

Depress foot pedal to fold cart for storage.



FOLDS FROM 34 3/8" TO 10 7/8" FOR EASY STORAGE

QUICK CONVERSION

Easily converts from a utility cart to a platform truck and then folds flat for storage.



UTILITY CART



PLATFORM TRUCK



Convertible Utility Cart

| NO. | COLOR | DESCRIPTION | U.S. DIMENSIONS | U.S. CAPACITY | U.S. SHIP WT/CTN | METRIC DIMENSIONS | METRIC CAPACITY | METRIC SHIP WT/CTN | PACK |
|----------|-------|--------------------------|---------------------------------------|---------------|------------------|--------------------------------------|-----------------|--------------------|------|
| FG430000 | BLA | Convertible Utility Cart | 45.2" l x 23.8" w x 34.4" h (Utility) | 400 lb | 52.0 lb | 115 cm x 60.5 cm x 87.4 cm (Utility) | 181 kg | 23.6 kg | 1 |

UTILITY REFUSE AND RECYCLING

DECORATIVE REFUSE

CLEANING

MATERIAL HANDLING

WASHROOM

FOODSERVICE

ACCESSORIES & INDEX

Executive Series™ Service Cart

The Executive Series™ Service Cart. is an elegant and versatile solution for back- and front-of-house tasks. With 20% more top-shelf capacity, it's constructed of durable, recyclable polyethylene and it's easy to clean—keeping your business looking smart for years.



EXECUTIVE SERIES™
FG9T6800BLA

ERGONOMIC ROUNDED HANDLES
Improves maneuverability and comfort.

WRAPAROUND END PANELS
Conceals cart contents.

SOLID ROUNDED BUMPER
Gentle on walls and furniture.

300-LB LOAD CAPACITY
Holds 100 lbs per shelf.



FG9T6800BLA

ATTRACTIVE STYLING
Ideal for front-of-house use.



FG9T6800BLA

INCREASED CAPACITY
Accommodates two standard bus boxes on top shelf.

| NO. | COLOR | DESCRIPTION | U.S. DIMENSIONS | U.S. CAPACITY | U.S. SHIP WT/CTN | METRIC DIMENSIONS | METRIC CAPACITY | METRIC SHIP WT/CTN | PACK |
|------------|------------|------------------------|-----------------------|---------------|------------------|-----------------------------|-----------------|--------------------|------|
| ⑤ FG9T6800 | BLA | Executive Service Cart | 39" l x 21" w x 38" h | 300 lbs | 31.5 lb | 99.1 cm x 53.3 cm x 96.5 cm | 136 kg | 14.3 kg | 1 |

Accessories

| NO. | COLOR | DESCRIPTION | U.S. DIMENSIONS | U.S. CAPACITY | U.S. SHIP WT/CTN | METRIC DIMENSIONS | METRIC CAPACITY | METRIC SHIP WT/CTN | PACK |
|-----------------------|------------------|-----------------|----------------------------|---------------|------------------|-----------------------------|-----------------|--------------------|------|
| FG335388 | BLA | Refuse Bin | 12" l x 17" w x 22" h | 8 gal | 9.0 lb | 30.5 cm x 43.2 cm x 55.9 cm | 30.3 L | 4.1 kg | 2 |
| FG335488 | BLA | Utility Bin | 12.13" l x 17" w x 10.5" h | 4 gal | 5.4 lb | 30.8 cm x 43.2 cm x 26.7 cm | 15.1 L | 2.4 kg | 2 |
| FG334900 ^a | WHT, GRAY | Bus/Utility Box | 20" l x 15" w x 5" h | 4.625 gal | 20.6 lb | 50.8 cm x 38.1 cm x 12.7 cm | 17.5 L | 9.3 kg | 12 |

^aCertified to NSF Standard #2 for food contact.

When ordering products with **BOLD** color codes, please specify color code after the product number. Refer to the Standard Color Guide at the back of the catalog.

UTILITY REFUSE AND RECYCLING

DECORATIVE REFUSE

CLEANING

MATERIAL HANDLING

WASHROOM

FOODSERVICE

ACCESSORIES & INDEX

Service Carts

Versatile, durable carts perform a wide variety of tasks.

- Molded shelves won't rust, dent, or require painting
- Easy-to clean, smooth surfaces
- Convenient handles and compact size enhance maneuverability
- Assists in complying with HACCP guidelines
- Nonmarking swivel casters reduce touch-up cleaning



FG9T6571



FG342100



FG345700



FG335588

| NO. | COLOR | DESCRIPTION | U.S. DIMENSIONS | U.S. CAPACITY | U.S. SHIP WT/CTN | METRIC DIMENSIONS | METRIC CAPACITY | METRIC SHIP WT/CTN | PACK |
|-----------------------|----------------------|---|--------------------------------|---------------|------------------|-----------------------------|-----------------|--------------------|------|
| FG9T6571 ^a | BEIG | Utility Cart with 3" dia (7.6 cm) Swivel Casters | 31.5" l x 16.25" w x 36" h | 100 lb | 212.0 lb | 80 cm x 41.3 cm x 91.4 cm | 45.3 kg | 96.2 kg | 6 |
| FG342100 | BLA | Utility Cart with 3" dia (7.6 cm) Swivel Casters and End Panels | 33.63" l x 18.63" w x 36.63" h | 150 lb | 34.0 lb | 85.4 cm x 47.3 cm x 93 cm | 68.0 kg | 15.4 kg | 1 |
| FG342488 | RED, PLAT, OWHT, BLA | Utility Cart with 4" dia (10.2 cm) Swivel Casters | 33.63" l x 18.63" w x 37.75" h | 200 lb | 30.0 lb | 85.4 cm x 47.3 cm x 95.9 cm | 90.7 kg | 13.6 kg | 1 |
| FG345700 | BLA | Utility Cart with Lockable Doors, Sliding Drawer, and 4" dia (10.2 cm) Swivel Casters | 33.63" l x 18.63" w x 37.75" h | 200 lb | 44.8 lb | 85.4 cm x 47.3 cm x 95.9 cm | 90.7 kg | 20.3 kg | 1 |
| FG335588 | PLAT | Utility Cart with Enclosed End Panels | 31" l x 18" w x 37.5" h | 300 lb | 37.5 lb | 78.7 cm x 45.7 cm x 95.3 cm | 136.1 kg | 17.0 kg | 1 |

^a Pallet Pack

Xtra™ Carts

Durable and attractive carts storage and transportation for front- and back-of-house applications.

- Metal uprights and molded shelves engineered for durability and appearance
- Nonmarking 4" swivel casters
- Wide shelves hold a variety of equipment and supplies, up to 300 lbs
- Available with locking doors and enclosure panels
- Accessories include refuse and utility bins (see page 183)



FG409300



FG409400



FG409500



FG409600

| NO. | COLOR | DESCRIPTION | U.S. DIMENSIONS | U.S. CAPACITY | U.S. SHIP WT/CTN | METRIC DIMENSIONS | METRIC CAPACITY | METRIC SHIP WT/CTN | PACK |
|----------|-----------------|---|-------------------------------|---------------|------------------|-------------------------------|-----------------|--------------------|------|
| FG409100 | OWHT, GRAY, BLA | Utility Cart, Open-Sided | 40.63" l x 20" w x 37.8" h | 300 lb | 43.4 lb | 103.2 cm x 50.8 cm x 96 cm | 136.1 kg | 19.7 kg | 1 |
| FG409300 | OWHT, BLA | Utility Cart with Enclosed End Panels on 3 Sides | 40.63" l x 20" w x 37.8" h | 300 lb | 51.6 lb | 103.2 cm x 50.8 cm x 96 cm | 136.1 kg | 23.4 kg | 1 |
| FG409400 | GRAY | Instrument Cart with Lockable Doors and Sliding Drawers | 40.63" l x 20" w x 37.8" h | 300 lb | 52.0 lb | 103.2 cm x 50.8 cm x 96 cm | 136.1 kg | 23.6 kg | 1 |
| FG409500 | BLA | Equipment Cart | 40.63" l x 20.75" w x 37.8" h | 300 lb | 58.5 lb | 103.2 cm x 52.7 cm x 96 cm | 136.1 kg | 26.5 kg | 1 |
| FG409600 | BLA | 4-Shelf Cart, Open-Sided | 40.63" l x 20" w x 51" h | 300 lb | 52.0 lb | 103.2 cm x 50.8 cm x 129.5 cm | 136.1 kg | 23.6 kg | 1 |

UTILITY REFUSE AND RECYCLING

DECORATIVE REFUSE

CLEANING

MATERIAL HANDLING

WASHROOM

FOODSERVICE

ACCESSORIES & INDEX



Ideal for moving loads in a variety of environments



Versatile solutions for any environment.



Efficiently transport large, bulky loads



Innovative designs to improve productivity

DURAMOLD™ REAL WORLD RUGGED — TESTED TOUGH

Rubbermaid's exclusive Duramold™ technology exceeds the highest performance standards in the industry. We test and retest our products to meet rigorous durability standards, and our material handling products are no exception. Real-world rugged durability, innovative technology, and best-in-class features combine to create longer-lasting products that carry heavy loads—and make your work easier.

WILL NOT WARP, DENT, SPLINTER, RUST, OR ROT

Tough, resilient surface absorbs impact and provides quiet operation. Virtually maintenance-free; resistant to most chemicals, impervious to water damage, and easily cleaned.



Metal—dents and rusts



Wood—splinters and rots



40 buckets of sheetrock compound weigh over 2,400 lbs

DURAMOLD™ precision-engineered resin and steel composite decks
HOLD & TRANSPORT UP TO

2500 lbs.

of weight load capacity

Duramold™ decks are formed from a precision-engineered resin and metal composite structure that is lighter than typical steel/wood products without sacrificing strength, which enables weight reduction and improved ergonomics.



PUT YOUR EFFORT INTO MOVING YOUR PAYLOAD, NOT YOUR TRUCK

DURAMOLD™ HAS THE HIGHEST STRENGTH-TO-WEIGHT RATIO

when compared to metal, wood, and solid plastic decks.

Heavy-Duty Platform Trucks

Ideal for moving large, heavy, oversized loads in a variety of environments from retail to construction.

DURAMOLD

DECK SIZES:

- 24" X 36"
- 24" X 48"
- 30" X 60"

CAPACITY RANGE (lbs)
1000-2500

IMPROVED MANEUVERABILITY

Variable grip-height handle improves control and worker safety.

VIRTUALLY MAINTENANCE-FREE

Powder-coated steel creates a hard finish that is far tougher than conventional paint.



BUILT-IN SAFETY FEATURES

Retainer clips prevent unintended handle removal.

SECURE SMALL ITEMS

Perimeter deck channel retains small items.

KEEP LOADS IN PLACE

Textured deck surface reduces load slippage.

RUGGED CONSTRUCTION

Duramold's™ exclusive, precision-engineered resin and metal composite structure provides maximum load support.



BETTER LOAD RETENTION

Four molded-in tie-down slots for securing loads with tie-down straps or bungees.



FG440300



FG440000BLA

Three-position handle provides better mobility and convenient storage.



| NO. | COLOR | DESCRIPTION | U.S. DIMENSIONS | U.S. CAPACITY | U.S. SHIP WT/CTN | METRIC DIMENSIONS | METRIC CAPACITY | METRIC SHIP WT/CTN | CASTER TYPE | PACK |
|----------|-------|---|-------------------|---------------|------------------|--------------------|-----------------|--------------------|---------------|------|
| FG440300 | BLA | Heavy-Duty Platform Truck | 36" l x 24" w | 1,000 lb | 50.0 lb | 91.4 cm x 61 cm | 453.6 kg | 22.7 kg | 6" TPR | 1 |
| FG440600 | BLA | Heavy-Duty Platform Truck | 36" l x 24" w | 2,000 lb | 50.0 lb | 91.4 cm x 61 cm | 453.6 kg | 22.7 kg | 6" Polyolefin | 1 |
| FG443600 | BLA | Heavy-Duty Platform Truck (Med 24" x 48") | 48" l x 24" w | 2,000 lb | 70.0 lb | 121.9 cm x 61 cm | 453.6 kg | 31.8 kg | 8" TPR | 1 |
| FG443610 | BLA | Heavy-Duty Platform Truck | 48" l x 24" w | 1,200 lb | 75.0 lb | 121.9 cm x 61 cm | 544.3 kg | 34 kg | 8" Pneumatic | 1 |
| FG444100 | BLA | Heavy-Duty Platform Truck | 48" l x 24" w | 2,500 lb | 69.0 lb | 121.9 cm x 61 cm | 1,134.0 kg | 31.3 kg | 8" Polyolefin | 1 |
| FG446600 | BLA | Heavy-Duty Platform Truck | 60" l x 30" w | 2,000 lb | 87.9 lb | 152.4 cm x 76.2 cm | 907.2 kg | 39.9 kg | 8" TPR | 1 |
| FG446610 | BLA | Heavy-Duty Platform Truck | 60" l x 30" w | 1,200 lb | 90.0 lb | 152.4 cm x 76.2 cm | 544.3 kg | 40.8 kg | 8" Pneumatic | 1 |
| FG447100 | BLA | Heavy-Duty Platform Truck | 60" l x 30" w | 2,500 lb | 84.0 lb | 152.4 cm x 76.2 cm | 1,134.0 kg | 38.1 kg | 8" Polyolefin | 1 |
| FG440000 | BLA | Triple™ Trolley, Utility-Duty with Straight Handle and 3" (7.6 cm) Casters | 32.5" l x 20.5" w | 250 lb | 20.6 lb | 82.6 cm x 52.1 cm | 113.4 kg | 9.3 kg | 1 | 1 |
| FG440100 | BLA | Triple™ Trolley, Standard Duty with User-Friendly Handle and 5" dia x .875" w (12.7 cm x 2.22 cm) Casters | 32.5" l x 20.5" w | 500 lb | 25.4 lb | 82.6 cm x 52.1 cm | 226.8 kg | 11.5 kg | 1 | 1 |



UTILITY REFUSE AND RECYCLING

DECORATIVE REFUSE

CLEANING

MATERIAL HANDLING

WASHROOM

FOODSERVICE

ACCESSORIES & INDEX

Sheet and Panel Trucks and A-Frame Panel Trucks

Transport large, bulky sheet goods and hard-to-handle loads such as doors, lumber, drywall, tables, and cubicle walls.



MOVE HARD-TO-HANDLE LOADS

Three removable powder-coated steel vertical frames provide support for bulky loads. Frames can be removed as needed based on load requirements.

BUILT-IN SAFETY FEATURES

Retainer clips lock frames securely in place and prevent unintended removal. Four tie-down points, two on each side, help with load retention.

FG446800

RUGGED CONSTRUCTION

Duramold's™ exclusive, precision-engineered resin and metal composite structure provides maximum load support.



HOLDS SHEET GOODS SECURELY

High-side inclined frame and side rail hold load firmly in place during transit.



KEEP LOADS IN PLACE

Textured deck surface reduces load slippage.

FG446300



Sheet and Panel Truck

| NO. | COLOR | DESCRIPTION | U.S. DIMENSIONS | U.S. CAPACITY | U.S. SHIP WT/CTN | METRIC DIMENSIONS | METRIC CAPACITY | METRIC SHIP WT/CTN | CASTER TYPE | PACK |
|----------|------------|-----------------------------------|------------------------------|---------------|------------------|-------------------------------|-----------------|--------------------|---------------|------|
| FG446800 | BLA | Sheet and Panel Truck (24" x 48") | 47.9" l x 24.25" w x 39.9" h | 2,000 lb | 98.0 lb | 121.7 cm x 61.6 cm x 101.3 cm | 907.2 kg | 44.5 kg | 8" Polyolefin | 1 |

A-Frame Panel Truck

| NO. | COLOR | DESCRIPTION | U.S. DIMENSIONS | U.S. CAPACITY | U.S. SHIP WT/CTN | METRIC DIMENSIONS | METRIC CAPACITY | METRIC SHIP WT/CTN | CASTER TYPE | PACK |
|----------|------------|---------------------------------|------------------------------|---------------|------------------|-----------------------------|-----------------|--------------------|---------------|------|
| FG446300 | BLA | A-Frame Panel Truck (24" x 48") | 47.9" l x 24.25" w x 44.9" h | 2,000 lb | 87.0 lb | 121.7 cm x 61.6 cm x 114 cm | 907.2 kg | 39.5 kg | 8" Polyolefin | 1 |

UTILITY REFUSE AND RECYCLING

DECORATIVE REFUSE

CLEANING

MATERIAL HANDLING

WASHROOM

FOODSERVICE

ACCESSORIES & INDEX

Side-Panel Platform Truck

Ideal for transporting small packages and materials.



CUSTOMIZABLE

Remove one, two, three, or all four side panels to accommodate any size load.



ENHANCE USER COMFORT

Side panel cutouts allow easy access to load.



BUILT-IN SAFETY FEATURES

Retainer clips prevent unintended handle removal.

RUGGED CONSTRUCTION

Duramold's™ exclusive, precision-engineered resin and metal composite structure provides maximum load support.

FG448600

3" X 3" GRID SIDE PANELS

Heavy-duty wire side panels retain small packages and items.

BETTER LOAD RETENTION

Molded-in tie-down slots increase load security. Textured deck surface reduces load slippage.

| NO. | COLOR | DESCRIPTION | U.S. DIMENSIONS | U.S. CAPACITY | U.S. SHIP WT/CTN | METRIC DIMENSIONS | METRIC CAPACITY | METRIC SHIP WT/CTN | CASTER TYPE | PACK |
|----------|-------|---------------------------------------|-----------------------------|---------------|------------------|-------------------------------|-----------------|--------------------|-------------|------|
| FG448600 | BLA | Side-Panel Platform Truck (24" x 48") | 56" l x 24.25" w x 41.25" h | 2,000 lb | 105.0 lb | 142.2 cm x 61.6 cm x 104.8 cm | 907.2 kg | 47.6 kg | 8" TPR | 1 |

UTILITY REFUSE AND RECYCLING

DECORATIVE REFUSE

CLEANING

MATERIAL HANDLING

WASHROOM

FOODSERVICE

ACCESSORIES & INDEX



CASTERS TO MEET YOUR NEEDS

Rubbermaid's best-in-class heavy-duty casters have been specially chosen for each of our products to meet your most demanding environments.



POLYOLEFIN

Hard-tread polyolefin casters roll easier than soft tread casters. Nonmarking, impact- and chemical-resistant casters won't flat-spot under static loads or pick up metal shavings, nails, and other debris.



PNEUMATIC

Pneumatic casters provide a cushioned and quiet ride for fragile loads, making them ideal for rough and uneven surfaces, inside and out.



THERMOPLASTIC RUBBER

TPR casters absorb shock, provide floor surface protection, and quiet operation. Chemical- and water-resistant.

CASTER PERFORMANCE GUIDE

| | CASTER TREAD MATERIAL | MOLD-ON RUBBER (TPR) | POLYOLEFIN | PNEUMATIC |
|---------------------------------------|------------------------------|-----------------------------|-------------------|------------------|
| FLOOR SURFACE | ASPHALT | Excellent | Fair | Excellent |
| | BRICK | Excellent | Fair | Excellent |
| | CARPET | Excellent | Good | Excellent |
| | CONCRETE | Excellent | Good | Excellent |
| | LINOLEUM / COMPOSITION TILE | Excellent | Fair | Excellent |
| | STEEL – RIBBED | Good | Fair | Excellent |
| | STEEL – SMOOTH | Good | Good | Excellent |
| | TERRAZZO | Excellent | Fair | Excellent |
| | WOOD | Excellent | Good | Excellent |
| OPERATING CONDITIONS | MILD CHEMICALS | Fair | Good | Good |
| | HARSH CHEMICALS | Fair | Fair | Good |
| | METAL SCRAPS – SMALL | Excellent | Good | Good |
| | METAL SCRAPS – LARGE | Excellent | Fair | Good |
| | ANIMAL FATS | Good | Good | Good |
| | OIL AND GREASE | Fair | Good | Fair |
| | WATER AND STEAM | Good | Excellent | Good |
| | OTHER FACTORS | FLOOR PROTECTION | Excellent | Good |
| QUIET OPERATION | Excellent | Fair | Excellent | |
| CUSHION LOAD | Excellent | N/A | Excellent | |
| IMPACT RESISTANCE | Excellent | Good | Excellent | |
| ROLLING EASE | Fair | Excellent | Fair | |
| ABRASION RESISTANCE (NONCHIPPING) | Fair | Good | Fair | |
| NON-FLAT-SPOTTING (UNDER STATIC LOAD) | Fair | Excellent | N/A | |

UTILITY REFUSE AND RECYCLING

DECORATIVE REFUSE

CLEANING

MATERIAL HANDLING

WASHROOM

FOODSERVICE

ACCESSORIES & INDEX

Cart Accessories



FG335388



FG335488



FG459000



FG459100



FG459200



FG459300

| Cart No. | FG335388 8-Gal (30.3 L) Refuse Bin Ship Weight: 9 lbs/4.1 kg Color: BLA | FG335488 4-Gal (15.3 L) Utility Bin Ship Weight: 5.4 lbs/2.4 kg Color: BLA | FG459000 3-Outlet, Surge-Protected Power Strip with 10' Cord Ship Weight: 3.4 lbs/1.5 kg Color: BLA | FG459100 Hook Kit (Set of 4) Ship Weight: 3.3 lbs/1.5 kg Color: BLA | FG459200 8" Pneumatic Caster Kit Ship Weight: 23.6 lbs/11.6 kg Color: 0000 | FG459300 Single Full-Extension Drawer Ship Weight: 13.5 lbs/6.1 kg Color: RED | FG619900 Utility Sliding Drawer Ship Weight: 4.5 lbs/2 kg Color: BBN, BLA |
|---|---|--|---|---|--|---|---|
| FG335588 Service Cart with Swivel Casters | ✓ | ✓ | | | | | |
| FG342100 Service Cart with 3" Swivel Casters | ✓ | ✓ | | | | | |
| FG342488 Service Cart with 4" Swivel Casters | ✓ | ✓ | | | | | |
| FG345700 Service Cart with Lockable Doors and Sliding Drawer | ✓ | ✓ | | | | | ✓ |
| FG409100 Open-Sided Utility Cart | ✓ | ✓ | | | | | ✓ |
| FG409300 Utility Cart with Enclosed End Panels on 3 Sides | ✓ | ✓ | | | | | ✓ |
| FG409400 Service Cart with Lockable Doors and Sliding Drawer | ✓ | ✓ | | | | | ✓ |
| FG409500 Service Cart with Lockable Doors, Enclosed on 3 Sides | ✓ | ✓ | | | | | ✓ |
| FG409600 4-Shelf Service Cart | ✓ | ✓ | ✓ | ✓ | ✓ | | |
| FG450088 Heavy-Duty Ergo Handle Utility Cart, Small | ✓ | ✓ | ✓ | ✓ | ✓ | | |
| FG451288 TradeMaster® Cart with 2-Door Cabinet | ✓ | ✓ | ✓ | ✓ | ✓ | | |
| FG451388 TradeMaster® Cart with 4-Drawers | ✓ | ✓ | ✓ | ✓ | ✓ | | |
| FG452010 Heavy-Duty Ergo Handle Utility Cart with Pneumatic Casters | ✓ | ✓ | ✓ | ✓ | ✓ | ✓ | |
| FG452088 Heavy-Duty Ergo Handle Utility Cart, Medium | ✓ | ✓ | ✓ | ✓ | ✓ | | |
| FG453388 TradeMaster® Cart with 4-Drawers and Cabinet, Small | ✓ | ✓ | ✓ | ✓ | ✓ | | |
| FG454600 Heavy-Duty Ergo Handle Utility Cart | ✓ | ✓ | ✓ | ✓ | ✓ | ✓ | |
| FG454610 Heavy-Duty Ergo Handle Utility Cart with Pneumatic Casters | ✓ | ✓ | ✓ | ✓ | ✓ | ✓ | |
| FG9T6600 2-Shelf Flat Handle Utility Cart | | | ✓ | ✓ | ✓ | | |
| FG9T6700 2-Shelf Flat Handle Utility Cart | | | ✓ | ✓ | ✓ | | |
| FG9T6800 Executive Series™ Service Cart | ✓ | ✓ | | | | | |

UTILITY REFUSE AND RECYCLING

DECORATIVE REFUSE

CLEANING

MATERIAL HANDLING

WASHROOM

FOODSERVICE

ACCESSORIES & INDEX



UTILITY REFUSE
AND RECYCLING

DECORATIVE REFUSE

CLEANING

MATERIAL HANDLING

WASHROOM

FOODSERVICE

ACCESSORIES
& INDEX

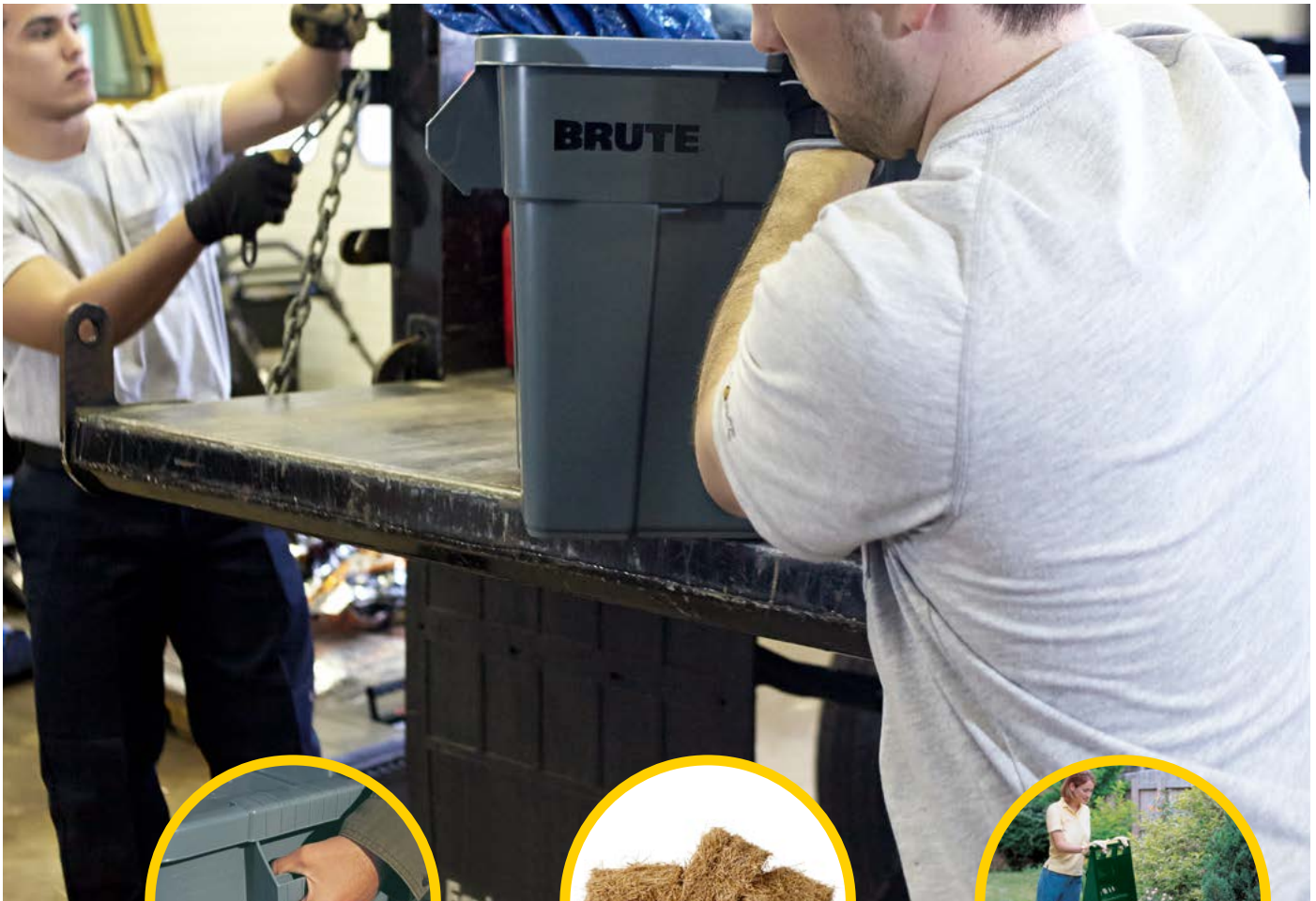

Ergonomic designs allow for easy transport



Super tough construction for superior performance



Designed for heavy-duty, long lasting use

Why Structural Foam?

STRENGTH

Superior strength without the need for a metal frame

DURABILITY

Seamless structures won't leak, rust, chip, dent, or peel, even under the heaviest use.

EFFICIENCY

Lighter weight means easier to operate.
Structural foam construction minimizes maintenance.



When ordering products with **BOLD** color codes, please specify color code after the product number. Refer to the Standard Color Guide at the back of the catalog.

Stock Tanks

Super-tough structural foam construction for superior performance and durability in all kinds of weather.

- Four sizes to fit all your watering needs, from 50 to 300 gallons
- Seamless construction for outstanding durability
- Oversize 1½" drain plug for easy draining and cleaning
- All-plastic anti-siphon float valve provides constant water level

STEPPED SIDEWALLS
Resist bowing and provide added stability.

SEAMLESS DESIGN
Prevents leaking and cracking.

REINFORCED RIBBING
Provides added strength and durability.



FG424288



FG424700



FG424300

FLOAT VALVE OPTION

STOCK TANK DRAIN PLUG KIT

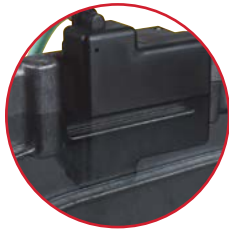

FG424806 fits all Rubbermaid® Stock Tanks.



FG505012 fits all Rubbermaid® Stock Tanks.

| NO. | COLOR | DESCRIPTION | U.S. DIMENSIONS | U.S. CAPACITY | U.S. SHIP WT/CTN | METRIC DIMENSIONS | METRIC CAPACITY | METRIC SHIP WT/CTN | PACK |
|----------|-------|----------------------------|--------------------------|---------------|------------------|-------------------------------|-----------------|--------------------|------|
| FG424300 | BLA | 50 U.S. Gallon Stock Tank | 52" l x 31" w x 12" h | 50 gal | 23.5 lb | 132.1 cm x 78.7 cm x 30.5 cm | 189.2 L | 10.7 kg | 1 |
| FG424288 | BLA | 100 U.S. Gallon Stock Tank | 53" l x 31" w x 25" h | 100 gal | 32.4 lb | 134.6 cm x 78.7 cm x 63.5 cm | 378.5 L | 14.7 kg | 1 |
| FG424500 | BLA | 150 U.S. Gallon Stock Tank | 58" l x 39" w x 25" h | 150 gal | 53.0 lb | 147.3 cm x 99.1 cm x 63.5 cm | 567.8 L | 24.0 kg | 1 |
| FG424700 | BLA | 300 U.S. Gallon Stock Tank | 63.25" l x 69" w x 25" h | 300 gal | 83.0 lb | 160.7 cm x 175.3 cm x 63.5 cm | 1135.5 L | 37.6 kg | 1 |
| FG424806 | BLA | Stock Tank Float Valve | 9" l x 5" w x 6.25" h | N/A | 12.0 lb | 22.9 cm x 12.7 cm x 15.9 cm | N/A | 5.4 kg | 6 |
| FG505012 | | Stock Tank Drain Plug Kit | N/A | N/A | 2.5 lb | N/A | N/A | 1.1 kg | 12 |



Big Wheel® Carts

Designed for heavy-duty, long-lasting use.

- Smooth, all-plastic, one-piece tub construction is easy to dump and clean
- Large pneumatic wheels provide maneuverability (FG564200)
- Large 20" semi-pneumatic wheels roll smoothly over rough surfaces (FG565461)
- FG565461 has a weighted load capacity of 200 lbs and holds up to 3.5 cu ft (.09 m³) level capacity or 4.0 cu ft (.11 m³) heaped capacity
- FG564200 has a weighted load capacity of 300 lbs and holds up to 7.5 cu ft (.2 m³) level capacity or 8.75 cu ft (.25 m³) heaped capacity



FG564200BLA

| NO. | COLOR | DESCRIPTION | U.S. DIMENSIONS | U.S. LOAD | U.S. SIZE | U.S. SHIP WT/CTN | METRIC DIMENSIONS | METRIC LOAD | METRIC SIZE | METRIC SHIP WT/CTN | PACK |
|----------|------------|---|-----------------------------|-----------|-----------|------------------|------------------------------|-------------|--------------------|--------------------|------|
| FG564200 | BLA | 7.5-Cu.-Ft. Big Wheel® Cart | 58" l x 32.75" w x 28.25" h | 300 lb | 7.5 cu ft | 45.2 lb | 147.3 cm x 83.2 cm x 71.8 cm | 136 kg | .21 m ³ | 20.5 kg | 1 |
| FG565461 | BLA | 3.5-Cu.-Ft. Big Wheel® Cart (Unassembled) | 47" l x 27.5" w x 24.75" h | 200 lb | 3.5 cu ft | 38.2 lb | 119.4 cm x 69.9 cm x 62.9 cm | 90.7 kg | .09 m ³ | 17.3 kg | 1 |
| M1564200 | | Wheel for FG564200 | N/A | N/A | N/A | N/A | N/A | N/A | N/A | N/A | 1 |
| 50565400 | | Axle for FG565461 | N/A | N/A | N/A | N/A | N/A | N/A | N/A | N/A | 1 |
| 52564200 | | Axle for FG564200 | N/A | N/A | N/A | 4.93 lb | N/A | N/A | N/A | N/A | 1 |

Heavy-Duty Big Wheel® Cart

Suitable for industrial, commercial, and agricultural work.

- Strong, durable one-piece construction carries up to 700 lbs (FG564210)
- High-flotation, 8" wide wheels provide easy mobility over most surfaces
- Reinforced steel axle for heavy-duty hauling



FG564210

| NO. | COLOR | DESCRIPTION | U.S. DIMENSIONS | U.S. LOAD | U.S. SIZE | U.S. SHIP WT/CTN | METRIC DIMENSIONS | METRIC LOAD | METRIC SIZE | METRIC SHIP WT/CTN | PACK |
|----------|------------|--|-----------------------|-----------|-----------|------------------|-----------------------------|-------------|--------------------|--------------------|------|
| FG564210 | BLA | 7.5-Cu.-Ft. Heavy-Duty Big Wheel® Cart | 57" l x 41" w x 26" h | 700 lb | 7.5 cu ft | 55.0 lb | 144.8 cm x 104.1 cm x 66 cm | 317 kg | .21 m ³ | 24.9 kg | 1 |

Utility Lawn Carts

Designed to move loads quickly and easily.

- Easy to lift and dump; handle features molded-in tool/beverage holder
- Smooth interior is easy to clean
- FG370712 holds up to 3.25 cu ft (.09 m³) level capacity or 4.5 cu ft (.127 m³) heaped capacity
- FG370612 holds up to 4.5 cu ft (.127 m³) level capacity or 5.75 cu ft (.16 m³) heaped capacity



FG370612



FG370712907

| NO. | COLOR | DESCRIPTION | U.S. DIMENSIONS | U.S. LOAD | U.S. SIZE | U.S. SHIP WT/CTN | METRIC DIMENSIONS | METRIC LOAD | METRIC SIZE | METRIC SHIP WT/CTN | PACK |
|----------|------------|--|-------------------------|-----------|------------|------------------|------------------------------|-------------|--------------------|--------------------|------|
| FG370612 | 714 | 4.5-Cu.-Ft. Roughneck Lawn Cart, Green | 48" l x 23.5" w x 28" h | 200 lb | 4.5 cu ft | 235.9 lb | 121.9 cm x 59.7 cm x 71.1 cm | 90.7 kg | .13 m ³ | 107.0 kg | 12 |
| FG370712 | 907 | 3.25-Cu.-Ft. Roughneck Lawn Cart, Platinum | 42.5" l x 21" w x 28" h | 200 lb | 3.25 cu ft | 195.6 lb | 108 cm x 53.3 cm x 71.1 cm | 90.7 kg | .09 m ³ | 88.7 kg | 12 |

UTILITY REFUSE AND RECYCLING

DECORATIVE REFUSE

CLEANING

MATERIAL HANDLING

WASHROOM

FOODSERVICE

ACCESSORIES & INDEX

BRUTE® Totes

The ultimate storage and transport container.

- Reinforced ribbed bottom protects container during dragging
- User-friendly grip handles decrease potential for back injury and finger strain
- Lid snaps tight, keeping contents secure



FG9S3000 / FG9S3100



FG9S3000 / FG440000

| NO. | COLOR | DESCRIPTION | U.S. DIMENSIONS | U.S. CAPACITY | U.S. SHIP WT/CTN | METRIC DIMENSIONS | METRIC CAPACITY | METRIC SHIP WT/CTN | PACK |
|----------|-----------|----------------------|--------------------------------|---------------|------------------|-----------------------------|-----------------|--------------------|------|
| FG9S3000 | WHT, GRAY | BRUTE® Tote with Lid | 27.88" l x 16.5" w x 10.7" h | 14 gal | 46.0 lb | 70.8 cm x 41.9 cm x 27.2 cm | 53 L | 20.9 kg | 6 |
| FG9S3100 | WHT, GRAY | BRUTE® Tote with Lid | 27.88" l x 17.38" w x 15.13" h | 20 gal | 53.0 lb | 70.8 cm x 44.1 cm x 38.4 cm | 75.7 L | 24.0 kg | 6 |

Stack and Nest Palletote® Boxes

For cost-effective storage and transportation.

- Fits 40" and 48" pallets with no overhang
- Nestable for efficient storage and transport, stackable with and without lids
- All plastic construction won't rust, dent, chip, or peel
- Rounded corners and smooth surfaces are easy to clean
- USDA 3A (Dairy) Sanitary Standards and Meat and Poultry Equipment Group Listed
- Slip-resistant, extended bottom
- Materials are FDA-compliant for food contact and certified to NSF Std. #2



FG172100



| NO. | COLOR | DESCRIPTION | U.S. DIMENSIONS | U.S. CAPACITY | U.S. SHIP WT/CTN | METRIC DIMENSIONS | METRIC CAPACITY | METRIC SHIP WT/CTN | PACK |
|----------|-------|----------------|---------------------------|---------------|------------------|-----------------------------|--------------------|--------------------|------|
| FG172100 | GRAY | Palletote® Box | 19.5" l x 15.5" w x 10" h | 1.3 cu ft | 42.6 lb | 49.5 cm x 39.4 cm x 25.4 cm | .04 m ³ | 19.3 kg | 10 |
| FG172200 | GRAY | Palletote® Box | 19.5" l x 15.5" w x 13" h | 1.6 cu ft | 57.9 lb | 49.5 cm x 39.4 cm x 33.0 cm | .05 m ³ | 26.3 kg | 10 |
| FG173100 | GRAY | Palletote® Box | 23.5" l x 19.5" w x 10" h | 2 cu ft | 60.6 lb | 59.7 cm x 49.5 cm x 25.4 cm | .06 m ³ | 27.5 kg | 10 |

Lids

| NO. | COLOR | DESCRIPTION | U.S. DIMENSIONS | U.S. CAPACITY | U.S. SHIP WT/CTN | METRIC DIMENSIONS | METRIC CAPACITY | METRIC SHIP WT/CTN | PACK |
|----------|-------|---------------------------------------|----------------------------|---------------|------------------|----------------------------|-----------------|--------------------|------|
| FG172000 | GRAY | Palletote® Lid for FG172100, FG172200 | 19.63" l x 15.63" w x 1" h | N/A | 16.1 lb | 49.9 cm x 39.7 cm x 2.5 cm | N/A | 7.3 kg | 10 |
| FG173000 | GRAY | Palletote® Lid for FG173100 | 23.75" l x 19.75" w x 1" h | N/A | 22.1 lb | 60.3 cm x 50.2 cm x 2.5 cm | N/A | 10.0 kg | 10 |



UTILITY REFUSE
AND RECYCLING



WASHROOM

DECORATIVE REFUSE

CLEANING

MATERIAL HANDLING

WASHROOM

FOODSERVICE

ACCESSORIES
& INDEX



1980826/1955230



1938171/1903286

SKIN CARE

Counter Mount Touch-Free and Manual

AutoFoam with LumeCel™ Technology.....191
 OneShot® Soap Refills.....192
 OneShot® Foam Dispensers193
 OneShot® Enriched Foam Refills.....193
 OneShot® Liquid Dispensers.....194
 Manual Soap System.....194
 OneShot® Enriched Lotion Refills.....194

Wall Mount Touch-Free

AutoFoam Touch-Free Skin Care System.....195
 AutoFoam Enriched Foam Refills.....195

Wall Mount Manual

Flex™ Dispensers.....196
 Flex™ Enriched Foam and Lotion Refills.....197
 Manual Foam Dispensers and Refills198

AIR CARE

Aerosol

Microburst® 3000 Dispensers and Refills202
 Microburst® 9000 Dispensers and Refills204
 Microburst® Duet Dispensers and Refills205
 Standard Aerosol Dispensers and Refills206

Passive

TCell™ 1.0 Dispensers and Refills.....207

FIXTURES

AutoFaucet®.....211
 Auto Flush®212

SURFACE CARE

AutoClean®214
 Auto Janitor®214
 Clean Seat215

ACCESSORIES

Baby Changing Stations.....216
 Sanitary Bins217
 Sanitary Napkin Receptacles.....217
 Safti-Grip® Bath and Shower Mats217

WASHROOM

UTILITY REFUSE
AND RECYCLING

DECORATIVE REFUSE

CLEANING

MATERIAL HANDLING

WASHROOM

FOODSERVICE

ACCESSORIES
& INDEX



SKIN CARE

Rubbermaid Skin Care Systems provide customers with a comprehensive hygiene program of innovative product solutions to deliver superior personal, economic, and environmental health.



Personal Health

- Enjoyable experience encourages hand washing
- Cleaner hands protect health
- Better health means reduced absenteeism



Economic Health

- Efficient product systems lower operational costs
- Reliable systems and healthy employees improve productivity
- High-quality restroom products improve tenant retention



Environmental Health

- Green Seal™ certified soaps, safer for the environment
- Touch-free innovation helps earn LEED credits
- Reduced packaging for lower environmental impact

AutoFoam with LumeCel™ Technology

The LumeCel™ AutoFoam Touch-Free Skin Care System provides the highest quality foam soap in an attractive touch-free dispenser that is powered by the LumeCel™ rechargeable energy system.

- Like a solar panel capturing energy from the sun, LumeCel™ captures energy from any indoor or natural light source.
- No alkaline batteries required
- Touch-free delivery eliminates cross contamination to help reduce the spread of germs
- Contemporary "clean look" dispenser available in a variety of color combinations
- Refill level and battery life indicators
- ADA compliant force and one-handed operation
- Contributes to earning LEED credits



• NSF and • Green Seal apply to specific refills only; see below.



1980826



1980828



SMART

LumeCel stores energy from light, providing its own internal energy source.



SUSTAINABLE

LumeCel helps reduce your overall contribution of batteries to landfill waste.



EFFICIENT

Save time and money with LumeCel's rechargeable energy, requiring zero alkaline batteries.

AutoFoam Skin Care Dispensers and Retrofit Cover

| NO. | DESCRIPTION | U.S. DIMENSIONS | U.S. SHIP WT/CASE | METRIC DIMENSIONS | METRIC SHIP WT/CASE | CASE PACK |
|---------|---|------------------------------|-------------------|-----------------------------|---------------------|-----------|
| 1980826 | AutoFoam Dispenser with LumeCel™ Technology – Black/Chrome | 5.51" l x 5.51" w x 11.22" h | 33.60 lb | 14.0 cm x 14.0 cm x 28.5 cm | 15.24 kg | 10 |
| 1980827 | AutoFoam Dispenser with LumeCel™ Technology – Black/Grey Pearl | 5.51" l x 5.51" w x 11.22" h | 33.60 lb | 14.0 cm x 14.0 cm x 28.5 cm | 15.24 kg | 10 |
| 1980828 | AutoFoam Dispenser with LumeCel™ Technology – White/Grey Pearl | 5.51" l x 5.51" w x 11.22" h | 33.60 lb | 14.0 cm x 14.0 cm x 28.5 cm | 15.24 kg | 10 |
| 1980829 | AutoFoam Dispenser with LumeCel™ Technology – Black/Black Pearl | 5.51" l x 5.51" w x 11.22" h | 33.60 lb | 14.0 cm x 14.0 cm x 28.5 cm | 15.24 kg | 10 |
| 1980831 | AutoFoam Dispenser with LumeCel™ Technology – White/Black Pearl | 5.51" l x 5.51" w x 11.22" h | 33.60 lb | 14.0 cm x 14.0 cm x 28.5 cm | 15.24 kg | 10 |

Foam Hand Wash

| NO. | DESCRIPTION | SIZE | U.S. SHIP WT/CASE | U.S. CASE CUBE | METRIC SHIP WT/CASE | METRIC CASE CUBE | CASE PACK |
|------------|--|---------|-------------------|----------------|---------------------|------------------|-----------|
| • FG750112 | Enriched Foam Hand Soap with Moisturizers | 1100 mL | 10.9 lb | 0.031 ft³ | 4.9 kg | 0.01 m³ | 4 |
| 2018595 | Enriched Foam Antibacterial Hand Wash — E2 | 1100 mL | 10.4 lb | 0.031 ft³ | 4.72 kg | 0.01 m³ | 4 |

Foam Hand Sanitizer

| NO. | DESCRIPTION | SIZE | U.S. SHIP WT/CASE | U.S. CASE CUBE | METRIC SHIP WT/CASE | METRIC CASE CUBE | CASE PACK |
|-----------|---|---------|-------------------|----------------|---------------------|------------------|-----------|
| • 2080802 | Enriched Foam Alcohol Hand Sanitizer — E3 | 1000 mL | 10.8 lb | 0.031 ft³ | 4.9 kg | 0.01 m³ | 4 |
| FG750593 | Enriched Foam Alcohol-Free Hand Sanitizer | 1100 mL | 10.9 lb | 0.031 ft³ | 4.9 kg | 0.01 m³ | 4 |



OneShot® Soap Refills

Featuring premium-quality enriched lotion and enriched foam hand soaps for a luxurious hand washing experience that delights users and encourages healthy hand washing. These rich lathering soaps are formulated with extra-mild ingredients and enriched with effective moisturizers to leave hands feeling soft and refreshed. All soaps are pH-balanced and designed for frequent washing. Biodegradable and Green Seal™ certified soaps meet higher environmental standards.

Available OneShot® Formulations:

Green Certified Lotion Soap (Liquid)

- Green Seal™ certified
- Hypoallergenic for sensitive skin
- Fresh light honeysuckle fragrance
- Rich, white pearlized appearance
- Biodegradable



Free 'N Clean Soap (Liquid & Foam)

- Enriched with glycerin, silk proteins, aloe vera, & vitamin E
- Hypoallergenic for sensitive skin
- Dye-free and fragrance-free
- Biodegradable

Hand Soap with Moisturizers (Liquid & Foam)

- Enriched with glycerin, aloe vera, & vitamin E
- Hypoallergenic for sensitive skin
- Light passion flower fragrance
- Rich, teal pearlized appearance
- Biodegradable

Antibacterial Hand Wash (Liquid)

- Kills up to 99.99% of germs
- Hypoallergenic for sensitive skin
- Dermatologist-tested
- Light floral fragrance
- Dye-free
- Biodegradable

Up to
72%

more solids
than other soap systems

For a luxurious feeling they'll remember.



Up to
4x

more hand washes
than traditional bag-in-box soaps

Delivers the lowest cost in use in the industry.



Kills up to
99.99%

of germs
(antibacterial soap & sanitizer)

Keeps employees and guests healthy.



UTILITY REFUSE AND RECYCLING

DECORATIVE REFUSE

CLEANING

MATERIAL HANDLING

WASHROOM

FOODSERVICE

ACCESSORIES & INDEX



OneShot® Foam Dispensers

The OneShot® System sets the standard for quality and reliability in counter-mounted soap dispensing. Luxurious formulas encourage healthy hand washing, and Smart Sensor™ technology detects hands, automatically delivering the perfect amount of soap—every time!

- Touch-free delivery eliminates cross-contamination to help reduce the spread of germs
- Reliable, controlled dispensing of concentrated soaps eliminates over-use and costly waste
- Refill and battery-life indicator lights
- Industry-leading battery life (up to 3 years or 120,000 cycles for OneShot® liquid dispensers; up to 2 years or 90,000 cycles for OneShot® foam dispensers)
- No clogs, drips, or messy cleanup
- Closed dispensing system provides world-class reliability
- Programmable options for 800mL and 1600mL refills
- Helps earn LEED credits
- 0.8mL target dosage



ADA COMPLIANT

| NO. | DESCRIPTION | U.S. SHIP WT/CASE | U.S. CASE CUBE | METRIC SHIP WT/CASE | METRIC CASE CUBE | CASE PACK |
|-----------|---|-------------------|----------------|---------------------|------------------|-----------|
| 1938171 | OneShot® Foam Dispenser Low Profile — Polished Chrome | 10.0 lb | 1.20 ft³ | 4.50 kg | 0.03 m³ | 4 |
| FG4870465 | OneShot® Foam Dispenser Low Profile Metal — Polished Chrome | 12.0 lb | 1.52 ft³ | 5.40 kg | 0.04 m³ | 4 |
| 490071 | OneShot® A/C Adapter | 1.2 lb | 0.17 ft³ | 0.50 kg | 0.01 m³ | 1 |
| 490099 | OneShot® 6V Adapter (bayonet) | 0.3 lb | 1.01 ft³ | 0.14 kg | 0.03 m³ | 1 |
| 490100 | OneShot® Adapter Wire (bayonet) | 0.1 lb | 1.50 ft³ | 0.06 kg | 0.04 m³ | 1 |

OneShot® Enriched Foam Refills (for use with OneShot® Foam Dispensers)

More hand washes per refill reduce labor and soap costs (up to 2,000 hand washes per refill)

- High quality formulations enriched with moisturizers
- Boxless refill means 80% less packaging waste over bulk gallon
- Free 'N Clean soap is specially formulated for frequent hand washing and NSF E1 approved†
- Sealed refill eliminates potential for contamination
- Green Seal™* certified, biodegradable, and pH balanced formulas



• NSF and • Green Seal apply to specific refills only; see below.



FG750517 FG750386 FG750389 FG750390

Enriched Foam Hand Wash Refills

| NO. | DESCRIPTION | SIZE | U.S. SHIP WT/CASE | U.S. CASE CUBE | METRIC SHIP WT/CASE | METRIC CASE CUBE | CASE PACK |
|------------|---|---------|-------------------|----------------|---------------------|------------------|-----------|
| • FG750517 | Enriched Foam Hand Soap with Moisturizers | 800 mL | 9.5 lb | 0.35 ft³ | 4.3 kg | 0.10 m³ | 4 |
| • FG750386 | Enriched Foam Hand Soap with Moisturizers | 1600 mL | 18.5 lb | 0.62 ft³ | 8.4 kg | 0.02 m³ | 4 |
| • FG750389 | Enriched Foam Free 'N Clean Soap — E1† | 800 mL | 9.5 lb | 0.35 ft³ | 4.3 kg | 0.10 m³ | 4 |
| • FG750390 | Enriched Foam Free 'N Clean Soap — E1† | 1600 mL | 18.5 lb | 0.62 ft³ | 8.4 kg | 0.02 m³ | 4 |

Use OneShot® Foam Dispensers only.

†NSF-approved E1 acceptable as a washing compound for use in establishments operating under the Federal meat, poultry, shell egg grading and egg products inspection programs.

*This product meets Green Seal™ Standard GS-41A based on effective performance and protective limits on VOCs and human & environmental toxicity. GreenSeal.org.





ADA COMPLIANT



FG401310



FG402073



FG401528



FG401832



FG402241



FG402243

SCAN FOR
INSTALLATION
VIDEOS



OneShot® Liquid Dispensers

| NO. | DESCRIPTION | U.S. SHIP WT/CASE | U.S. CASE CUBE | METRIC SHIP WT/CASE | METRIC CASE CUBE | CASE PACK |
|----------|--|-------------------|----------------|---------------------|------------------|-----------|
| FG401310 | OneShot® Liquid Dispenser — Polished Chrome/Black | 8.0 lb | 1.15 ft³ | 3.63 kg | 0.03 m³ | 4 |
| FG402073 | OneShot® Liquid Dispenser — Polished Chrome | 8.0 lb | 1.15 ft³ | 3.63 kg | 0.03 m³ | 4 |
| FG401528 | OneShot® Liquid Dispenser — Brushed Chrome/Black | 8.0 lb | 1.15 ft³ | 3.63 kg | 0.03 m³ | 4 |
| FG401832 | OneShot® Liquid Dispenser Metal Spout — Polished Chrome/Black | 10.0 lb | 1.15 ft³ | 4.50 kg | 0.03 m³ | 4 |
| FG402241 | OneShot® Liquid Dispenser Low Profile — Polished Chrome | 12.0 lb | 1.15 ft³ | 5.40 kg | 0.03 m³ | 4 |
| FG402243 | OneShot® Liquid Dispenser Low Profile Metal — Polished Chrome | 12.0 lb | 1.15 ft³ | 5.40 kg | 0.03 m³ | 4 |
| FG500394 | OneShot® 800 mL Starter Kit (Chrome/Black Dispenser, Hand Wash Refill, 4 D Batteries) | 6.0 lb | 0.40 ft³ | 2.72 kg | 0.01 m³ | 1 |
| FG500449 | OneShot® 1600 mL Starter Kit (Chrome/Black Dispenser, Hand Wash Refill, 4 D Batteries) | 8.0 lb | 0.40 ft³ | 3.63 kg | 0.01 m³ | 1 |
| 490071 | OneShot® A/C Adapter | 1.2 lb | 0.17 ft³ | 0.50 kg | 0.01 m³ | 1 |
| 490099 | OneShot® 6V Adapter (bayonet) | 0.3 lb | 1.01 ft³ | 0.14 kg | 0.03 m³ | 1 |
| 490100 | OneShot® Adapter Wire (bayonet) | 0.1 lb | 1.50 ft³ | 0.06 kg | 0.04 m³ | 1 |

Manual Soap System

Attractive, manually operated counter-mounted dispensing system.



ADA COMPLIANT



FG401544

| NO. | DESCRIPTION | U.S. SHIP WT/CASE | U.S. CASE CUBE | METRIC SHIP WT/CASE | METRIC CASE CUBE | CASE PACK |
|----------|---|-------------------|----------------|---------------------|------------------|-----------|
| FG401544 | Manual Liquid Dispenser — Polished Chrome | 7.5 lb | 0.79 ft³ | 3.40 kg | 0.02 m³ | 12 |

**OneShot® Enriched Lotion Refills
(for use with OneShot® Liquid Dispensers)**

- More hand washes per refill reduce labor and soap costs (up to 2000 hand washes per refill)
- High-quality formulations enriched with moisturizers
- Sealed refill eliminates potential for contamination
- Wide choice of formulations including dye and fragrance-free, hypoallergenic, and antimicrobial options
- Green Seal™* certified lotion soap



FG4013131 / FG4015431 | FG402363 / FG402364 | FG4013111 / FG4015411 | 2018581 / 2018582

| NO. | DESCRIPTION | SIZE | U.S. SHIP WT/CASE | U.S. CASE CUBE | METRIC SHIP WT/CASE | METRIC CASE CUBE | CASE PACK |
|-----------|---|---------|-------------------|----------------|---------------------|------------------|-----------|
| FG4013131 | Green Seal Certified Lotion Soap | 800 mL | 9.0 lb | 0.33 ft³ | 4.1 kg | 0.01 m³ | 4 |
| FG4015431 | Green Seal Certified Lotion Soap | 1600 mL | 18.0 lb | 0.50 ft³ | 8.2 kg | 0.01 m³ | 4 |
| FG402363 | Enriched Lotion Free 'N Clean Soap | 800 mL | 9.0 lb | 0.33 ft³ | 4.1 kg | 0.01 m³ | 4 |
| FG402364 | Enriched Lotion Free 'N Clean Soap | 1600 mL | 18.0 lb | 0.50 ft³ | 8.2 kg | 0.01 m³ | 4 |
| FG4013111 | Enriched Lotion Hand Soap with Moisturizers | 800 mL | 9.0 lb | 0.33 ft³ | 4.1 kg | 0.01 m³ | 4 |
| FG4015411 | Enriched Lotion Hand Soap with Moisturizers | 1600 mL | 18.0 lb | 0.50 ft³ | 8.2 kg | 0.01 m³ | 4 |
| 2018581 | Enriched Lotion Antibacterial Hand Wash | 1600 mL | 16.3 lb | 0.55 ft³ | 7.4 kg | 0.02 m³ | 4 |
| 2018582 | Enriched Lotion Antibacterial Hand Wash | 800 mL | 8.50 lb | 0.33 ft³ | 3.9 kg | 0.01 m³ | 4 |

*This product meets Green Seal™ Standard GS-41A based on effective performance and protective limits on VOCs and human & environmental toxicity. GreenSeal.org.

AutoFoam Touch-Free Skin Care System

Highest quality foam soap in an attractive touch-free dispenser delivers superior cost savings.

- Touch-free delivery eliminates cross contamination to help reduce the spread of germs
- Industry-leading battery life of 3 years or 120,000 hand washes*
- Contemporary "clean look" dispenser available in a variety of color combinations to enhance the image of any washroom décor
- Refill level and battery life indicators
- Boxless refill means 80% less packaging waste over bulk gallon
- ADA compliant force and one-handed operation
- Helps earn LEED credits
- 0.4mL target dosage



FG750127



FG750139



FG750138



FG750140



FG750411

| NO. | DESCRIPTION | U.S. DIMENSIONS | U.S. SHIP WT/CASE | U.S. CASE CUBE | METRIC DIMENSIONS | METRIC SHIP WT/CASE | METRIC CASE CUBE | CASE PACK |
|----------|--|------------------------------|-------------------|-----------------------|-----------------------------|---------------------|---------------------|-----------|
| FG750127 | AutoFoam Dispenser — Black/Black Pearl | 5.25" l x 5.18" w x 10.86" h | 24.75 lb | 25.25 ft ³ | 13.3 cm x 13.2 cm x 27.6 cm | 11.2 kg | 0.72 m ³ | 10 |
| FG750138 | AutoFoam Dispenser — White/Black Pearl | 5.25" l x 5.18" w x 10.86" h | 24.75 lb | 25.25 ft ³ | 13.3 cm x 13.2 cm x 27.6 cm | 11.2 kg | 0.72 m ³ | 10 |
| FG750139 | AutoFoam Dispenser — Black/Grey Pearl | 5.25" l x 5.18" w x 10.86" h | 24.75 lb | 25.25 ft ³ | 13.3 cm x 13.2 cm x 27.6 cm | 11.2 kg | 0.72 m ³ | 10 |
| FG750140 | AutoFoam Dispenser — White/Grey Pearl | 5.25" l x 5.18" w x 10.86" h | 24.75 lb | 25.25 ft ³ | 13.3 cm x 13.2 cm x 27.6 cm | 11.2 kg | 0.72 m ³ | 10 |
| FG750411 | AutoFoam Dispenser — Black/Chrome | 5.25" l x 5.18" w x 10.86" h | 24.75 lb | 25.25 ft ³ | 13.3 cm x 13.2 cm x 27.6 cm | 11.2 kg | 0.72 m ³ | 10 |
| 1892265 | AutoFoam Drip Tray | 4.30" l x 3.90" w x 5.70" h | 10.10 lb | 0.44 ft ³ | 10.9 cm x 9.9 cm x 14.5 cm | 4.60 kg | 0.01 m ³ | 6 |

AutoFoam Enriched Foam Refills (for use with AutoFoam Dispensers)

More hand washes per refill reduce labor and soap costs

- High capacity refill delivers up to 2,750 hand washes
- Moisture Enriched Foam hand sanitizers in alcohol and alcohol-free formulas that leave no sticky residue
- Hygienically sealed refills eliminate potential contamination
- Boxless refills evacuate fully to reduce waste
- Green Seal™* certified, biodegradable, and pH balanced hand soap
- Antibacterial foam soap kills 99.99% of germs; NSF Rated E2
- NSF E3-rated foam alcohol hand sanitizer formula



FG750112



2018595



2080802



FG750593



● NSF and ● Green Seal apply to specific refills only; see below.

Foam Hand Wash

| NO. | DESCRIPTION | SIZE | U.S. SHIP WT/CASE | U.S. CASE CUBE | METRIC SHIP WT/CASE | METRIC CASE CUBE | CASE PACK |
|------------|--|---------|-------------------|----------------------|---------------------|---------------------|-----------|
| ● FG750112 | Enriched Foam Hand Soap with Moisturizers | 1100 mL | 10.9 lb | 0.31 ft ³ | 4.9 kg | 0.01 m ³ | 4 |
| ● 2018595 | Enriched Foam Antibacterial Hand Wash — E2 | 1100 mL | 10.4 lb | 0.31 ft ³ | 4.72 kg | 0.01 m ³ | 4 |

Foam Hand Sanitizer

| NO. | DESCRIPTION | SIZE | U.S. SHIP WT/CASE | U.S. CASE CUBE | METRIC SHIP WT/CASE | METRIC CASE CUBE | CASE PACK |
|------------|---|---------|-------------------|----------------------|---------------------|---------------------|-----------|
| ● 2080802 | Enriched Foam Alcohol Hand Sanitizer — E3 | 1000 mL | 10.8 lb | 0.31 ft ³ | 4.9 kg | 0.01 m ³ | 4 |
| ● FG750593 | Enriched Foam Alcohol-Free Hand Sanitizer | 1100 mL | 10.9 lb | 0.31 ft ³ | 4.9 kg | 0.01 m ³ | 4 |



FLex™ Dispensers

FLex™ Skin Care System's revolutionary design allows you to use either foam or liquid refills in the same dispenser.

- Highest yield of hand washes—up to 3,250 per refill
- Signature Moisturizing Complex with shea butter, vitamin E, and panthenol
- Rich, dense lather and distinctive fragrances
- Accurate, adjustable, on-unit dose meter for effective portion control
- Superior "clean look" styling improves washroom aesthetics
- NSF-registered E2 and E3 formulas
- New 75% alcohol hand sanitizer kills over 99.99% of germs—E3-rated
- Unique alcohol-free hand sanitizer kills 99.99% of germs without alcohol—ideal for children (E3-rated)
- 2 sizes to meet any capacity, space, or installation requirement
- Hygienically sealed refills eliminate potential contamination
- Boxless refills evacuate fully to reduce waste
- 0.4, 0.65, 1.0 mL target dosage



The only system with adjustable portion control ON the dispenser — choose from 3 dose sizes: 0.4 mL – 0.65 mL – 1.0 mL.



FLex™ Skin Care Dispensers

| NO. | DESCRIPTION | U.S. DIMENSIONS | U.S. SHIP WT/CASE | U.S. CASE CUBE | METRIC DIMENSIONS | METRIC SHIP WT/CASE | METRIC CASE CUBE | CASE PACK |
|---------|---|------------------------------|-------------------|----------------|---------------------------|---------------------|------------------|-----------|
| 3486589 | Rubbermaid FLex™ Dispenser White — 500 mL | 3.94" d x 5.00" w x 8.67" h | 9.5 lb | 1.36 ft³ | 10 cm x 12.7 cm x 22 cm | 4.31 kg | 0.04 m³ | 10 |
| 3486590 | Rubbermaid FLex™ Dispenser Black — 500 mL | 3.94" d x 5.00" w x 8.67" h | 9.5 lb | 1.36 ft³ | 10 cm x 12.7 cm x 22 cm | 4.31 kg | 0.04 m³ | 10 |
| 3486591 | Rubbermaid FLex™ Dispenser White — 1000 mL, 1300 mL | 3.94" d x 5.75" w x 11.73" h | 13.7 lb | 1.91 ft³ | 10 cm x 14.6 cm x 29.8 cm | 6.23 kg | 0.04 m³ | 10 |
| 3486592 | Rubbermaid FLex™ Dispenser Black — 1000 mL, 1300 mL | 3.94" d x 5.75" w x 11.73" h | 13.7 lb | 1.91 ft³ | 10 cm x 14.6 cm x 29.8 cm | 6.23 kg | 0.04 m³ | 10 |



Accessories

| NO. | DESCRIPTION | U.S. SHIP WT/CASE | U.S. CASE CUBE | METRIC SHIP WT/CASE | METRIC CASE CUBE | CASE PACK |
|----------|--|-------------------|----------------|---------------------|------------------|-----------|
| 3486593* | Rubbermaid FLex™ Manual Dispenser Drip Tray — Grey | 0.8 lb | 0.29 ft³ | 0.36 kg | 0.01 m³ | 6 |

* Dispenser not included

When ordering products with **BOLD** color codes, please specify color code after the product number. Refer to the Standard Color Guide at the back of the catalog.

UTILITY REFUSE AND RECYCLING

DECORATIVE REFUSE

CLEANING

MATERIAL HANDLING

WASHROOM

FOODSERVICE

ACCESSORIES & INDEX

FLex™ Enriched Foam Refills
(for use with FLex™ Dispensers)



● NSF and ● Green Seal apply to specific refills only; see below.



Foam Hand Wash & Body Shampoo

| NO. | DESCRIPTION | SIZE | U.S. SHIP WT/CASE | U.S. CASE CUBE | METRIC SHIP WT/CASE | METRIC CASE CUBE | CASE PACK |
|-----------|--|---------|-------------------|----------------------|---------------------|---------------------|-----------|
| ● 3486561 | Enriched Foam Hand Wash | 500 mL | 6.64 lb | 0.41 ft ³ | 3.01 kg | 0.01 m ³ | 5 |
| ● 3486571 | Enriched Foam Hand Wash | 1300 mL | 9.75 lb | 0.48 ft ³ | 4.42 kg | 0.01 m ³ | 3 |
| ● 3486575 | Enriched Foam Hand & Body Shampoo | 1300 mL | 9.74 lb | 0.48 ft ³ | 4.42 kg | 0.01 m ³ | 3 |
| ● 2018596 | Enriched Foam Antibacterial Hand Wash — E2 | 1300 mL | 9.92 lb | 0.40 ft ³ | 4.50 kg | 0.01 m ³ | 3 |

Foam Hand Sanitizers

| NO. | DESCRIPTION | SIZE | U.S. SHIP WT/CASE | U.S. CASE CUBE | METRIC SHIP WT/CASE | METRIC CASE CUBE | CASE PACK |
|-----------|---|---------|-------------------|----------------------|---------------------|---------------------|-----------|
| ● 3486577 | Enriched Foam Alcohol Plus Hand Sanitizer — E3 | 1000 mL | 8.56 lb | 0.48 ft ³ | 3.88 kg | 0.01 m ³ | 3 |
| ● 3486579 | Enriched Foam Alcohol-Free Plus Hand Sanitizer — E3 | 1300 mL | 9.67 lb | 0.48 ft ³ | 4.39 kg | 0.01 m ³ | 3 |

FLex™ Enriched Lotion Refills
(for use with FLex™ Dispensers)



● NSF and ● Green Seal apply to specific refills only; see below.



| NO. | DESCRIPTION | SIZE | U.S. SHIP WT/CASE | U.S. CASE CUBE | METRIC SHIP WT/CASE | METRIC CASE CUBE | CASE PACK |
|-----------|-------------------------------------|---------|-------------------|----------------------|---------------------|---------------------|-----------|
| ● 3486562 | Enriched Lotion Hand Wash | 500 mL | 6.77 lb | 0.41 ft ³ | 3.07 kg | 0.01 m ³ | 5 |
| ● 3486572 | Enriched Lotion Hand Wash | 1300 mL | 9.82 lb | 0.48 ft ³ | 4.45 kg | 0.01 m ³ | 3 |
| 3486576 | Enriched Lotion Hand & Body Shampoo | 1300 mL | 10.15 lb | 0.48 ft ³ | 4.60 kg | 0.01 m ³ | 3 |

UTILITY REFUSE AND RECYCLING

DECORATIVE REFUSE

CLEANING

MATERIAL HANDLING

WASHROOM

FOODSERVICE

ACCESSORIES & INDEX



Manual Foam Dispensers and Refills

The perfect balance between quality and value.

- Metered pump provides controlled dose of high-density foam for 2,000 hand washes per refill
- Antimicrobial push bar
- Hygienic sealed refills keep soap fresh and clean
- Highly concentrated foam hand cleansers
- 0.4 mL target dosage



• NSF apply to specific refills only; see below.



1853755



FG450017



FG450034

Foam Skin Care Dispensers

| NO. | DESCRIPTION | U.S. DIMENSIONS | U.S. SHIP WT/CASE | U.S. CASE CUBE | METRIC DIMENSIONS | METRIC SHIP WT/CASE | METRIC CASE CUBE | CASE PACK |
|----------|---|------------------------------|-------------------|----------------------|-----------------------------|---------------------|---------------------|-----------|
| FG450017 | Foam Skin Care Dispenser 800 mL — White | 5.25" l x 4.75" w x 9.75" h | 1.3 lb | 2.04 ft ³ | 13.3 cm x 12.1 cm x 24.8 cm | 0.6 kg | 0.06 m ³ | 10 |
| FG450034 | Foam Skin Care Dispenser 800 mL — Black | 5.25" l x 4.75" w x 9.75" h | 1.0 lb | 2.17 ft ³ | 13.3 cm x 12.1 cm x 24.8 cm | 0.5 kg | 0.06 m ³ | 10 |
| 1853755 | Foam Skin Care Dispenser 800 mL — Stainless | 5.51" l x 4.92" w x 10.63" h | 1.3 lb | 2.04 ft ³ | 14 cm x 12.5 cm x 27 cm | 0.6 kg | 0.06 m ³ | 10 |



FG450019



2018598



FG751001



FG750592

Enriched Foam Hand Wash Refills (for use with Manual Foam Dispenser)

| NO. | DESCRIPTION | SIZE | U.S. SHIP WT/CASE | U.S. CASE CUBE | METRIC SHIP WT/CASE | METRIC CASE CUBE | CASE PACK |
|----------|-----------------------------------|--------|-------------------|----------------------|---------------------|---------------------|-----------|
| FG450019 | Foam Hand Soap with Moisturizers | 800 mL | 12.8 lb | 0.33 ft ³ | 5.8 kg | 0.01 m ³ | 6 |
| 2018598 | Foam Antibacterial Hand Wash — E2 | 800 mL | 12.4 lb | 0.34 ft ³ | 5.8 kg | 0.01 m ³ | 6 |

Enriched Foam Hand & Body Wash Refills (for use with Manual Foam Dispenser)

| NO. | DESCRIPTION | SIZE | U.S. SHIP WT/CASE | U.S. CASE CUBE | METRIC SHIP WT/CASE | METRIC CASE CUBE | CASE PACK |
|----------|-----------------------|--------|-------------------|----------------------|---------------------|---------------------|-----------|
| FG751001 | Foam Hand & Body Wash | 800 mL | 12.8 lb | 0.33 ft ³ | 5.8 kg | 0.01 m ³ | 6 |

Enriched Foam Hand Sanitizers (for use with Manual Foam Dispenser)

| NO. | DESCRIPTION | SIZE | U.S. SHIP WT/CASE | U.S. CASE CUBE | METRIC SHIP WT/CASE | METRIC CASE CUBE | CASE PACK |
|----------|----------------------------------|---------|-------------------|----------------------|---------------------|---------------------|-----------|
| FG750592 | Foam Alcohol-Free Hand Sanitizer | 800 mL | 12.8 lb | 0.33 ft ³ | 5.8 kg | 0.01 m ³ | 6 |
| 2080803 | Foam Alcohol Hand Sanitizer | 1000 mL | 10.8 lb | 0.39 ft ³ | 4.9 kg | 0.01 m ³ | 4 |



1980826



AIR CARE

Rubbermaid Air Care Systems ensure that the first things you and your customers notice when you enter your washroom is a clean, fresh, and pleasant fragrance.

By combining innovative and reliable dispensing technologies with our select fragrances, our automated air care systems are highly cost-efficient and long-lasting, delivering consistent and continuous freshness, and offering the perfect solution to suit your specific washroom needs.



FLORAL

Characterized by radiant notes such as rose, jasmine, violet; green notes which are reminiscent of freshly cut grass, leaves, and stems.



FRUITY

Characterized by luscious fruity notes such as apple, pear, plum, mango, peach, and melon.



CITRUS

Characterized by invigorating & uplifting notes such as lemon, mandarin, and other citrus oils.



HERBAL

Characterized by powerful, aromatic herbal notes such as rosemary, mint, coriander, lavender, and sage.



FOUGÈRE

Characterized by masculine notes such as lavender, moss, and woods.



GOURMAND

Characterized by mouthwatering, edible notes and sweet, comforting vanilla.

AVAILABLE FRAGRANCES

FLORAL:

Cotton Berry
Country Delight™
Cucumber Melon
Island Melon
Sea Mist
Summer Sorbet
Wakening Spring

FRUITY:

Cherry Berry
Cucumber Melon
Delicious Apple
Gentle Breeze
Mango
Mango Blossom
Mountain Peaks
Mountain Spa™
Orchard Fields
Tropical Sunrise
Tropix

CITRUS:

Citrus
Green Tea
Lemon
Mandarin Orange
Refreshing Citrus

HERBAL:

Crystal Breeze
Ocean Breeze
Polar Mist
Santa Fe

FOUGÈRE:

Alpine Spring
Blue Splash
Linen Fresh™

GOURMAND:

Apple Cinnamon
Cinnamon Spice
Sugar Cookie
Vanilla
Vanilla Coconut
Vanilla Crème
Vanilla Royale

FRAGRANCE INTENSITY

Aerosol Fragrances

Microburst® 3000 & Microburst® 9000

| | | | | | | | | | | | |
|--------------|----------------|-------|--------------|----------------|----------------|-----------|----------------|----------------|-------------|-----------------|------------------|
| Linen Fresh™ | Vanilla Royale | Mango | Ocean Breeze | Cucumber Melon | Mountain Peaks | Green Tea | Cinnamon Spice | Orchard Fields | Blue Splash | Mandarin Orange | Country Delight™ |
|--------------|----------------|-------|--------------|----------------|----------------|-----------|----------------|----------------|-------------|-----------------|------------------|

MILD

INTENSE

Microburst® Duet

| | | | | | | | |
|---------------|-------|--------------|----------|---------------|----------------|--------------|-------------------|
| Gentle Breeze | Linen | Ocean Breeze | Sea Mist | Alpine Spring | Mountain Peaks | Cotton Berry | Refreshing Citrus |
|---------------|-------|--------------|----------|---------------|----------------|--------------|-------------------|

MILD

INTENSE

Standard Aerosol

| | | | | | | | | | | | |
|--------------|----------------|-------|--------------|----------------|----------------|-----------------|----------------|-------------|-----------------|------------------|-------|
| Linen Fresh™ | Vanilla Royale | Mango | Ocean Breeze | Mountain Peaks | Cinnamon Spice | Delicious Apple | Orchard Fields | Blue Splash | Mandarin Orange | Country Delight™ | Lemon |
|--------------|----------------|-------|--------------|----------------|----------------|-----------------|----------------|-------------|-----------------|------------------|-------|

MILD

INTENSE

Non-Aerosol Fragrances

Pump Odor Control

| | | | | | | |
|--------------|---------|--------------|---------------|----------|--------|------------------|
| Linen Fresh™ | Vanilla | Ocean Breeze | Mountain Spa™ | Santa Fe | Tropix | Country Delight™ |
|--------------|---------|--------------|---------------|----------|--------|------------------|

MILD

INTENSE

Gel Odor Control

| | | | | | | | |
|--------------|-----------------|--------------|--------------|-----------------|-----------------|--------------|------------------|
| Linen Fresh™ | Vanilla Coconut | Ocean Breeze | Island Melon | Delicious Apple | Mandarin Orange | Cherry Berry | Country Delight™ |
|--------------|-----------------|--------------|--------------|-----------------|-----------------|--------------|------------------|

MILD

INTENSE

TCell™ Odor Control

| | | | | | | | | | | | | |
|-----------------|------------|-------------|----------------|--------|---------------|----------------|------------------|---------------|------------------------|---------------|--------------|----------------|
| Wakening Spring | Polar Mist | Blue Splash | Crystal Breeze | Citrus | Mango Blossom | Cucumber Melon | Tropical Sunrise | Summer Sorbet | Pure™ Odor Neutralizer | Vanilla Crème | Sugar Cookie | Apple Cinnamon |
|-----------------|------------|-------------|----------------|--------|---------------|----------------|------------------|---------------|------------------------|---------------|--------------|----------------|

MILD

INTENSE

Microtrans® Technology

Traditional air fresheners only camouflage malodors. Rubbermaid Commercial Products Air Care Systems are engineered to do the complete job! All RCP formulas contain Microtrans®, a true odor neutralizer, which is paired with the industry's highest quality fragrances to effectively eliminate "unavoidable odors" in commercial washrooms. And it contains 63% fewer VOCs per spray than standard aerosol.

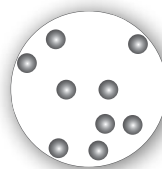

Unavavoidable odors creating an unpleasant restroom environment

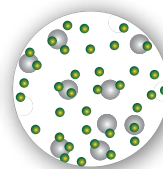

Microtrans® penetrating and soaking into malodor particles

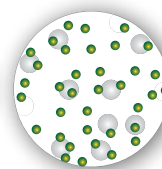

Microtrans® transforming malodors into a neutral base

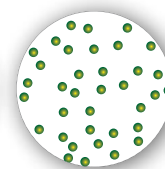

Creating a fresh, hygienic, and comfortable restroom environment

Microburst® 3000 with LumeCel™ Technology

Battery-Free Dispensing Systems

- Rubbermaid Commercial Products introduces a revolutionary new technology to air care—the Microburst® 3000, powered by the LumeCel™ rechargeable energy system.
- With easy, flexible programming, and world-class reliability, the Microburst® 3000 offers an effective air freshening system that is now better and safer for the environment.



63%
FEWER VOCs
PER SPRAY
than standard aerosol

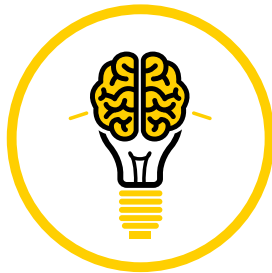

SMART

LumeCel stores energy from light, providing its own internal energy source.



SUSTAINABLE

LumeCel helps reduce your overall contribution of batteries to landfill waste.



EFFICIENT

Save time and money with LumeCel's rechargeable energy, requiring zero alkaline batteries.



Scan for General Information



Scan for Video



1955228



1955229



1955230

Microburst® 3000 Dispensers with LumeCel™ Technology (See page 203 for refills).

| NO. | DESCRIPTION | U.S. DIMENSIONS | U.S. SHIP WT/CASE | METRIC DIMENSIONS | METRIC SHIP WT/CASE | CASE PACK |
|---------|--|-----------------------|-------------------|-------------------------------|---------------------|-----------|
| 1955228 | Microburst® 3000 Dispenser with LumeCel™ Technology — Black | 4.75" w x 8" h x 5" l | 7.8 lb | 12.06 cm x 20.32 cm x 12.7 cm | 3.5 kg | 6 |
| 1955229 | Microburst® 3000 Dispenser with LumeCel™ Technology — White | 4.75" w x 8" h x 5" l | 7.8 lb | 12.06 cm x 20.32 cm x 12.7 cm | 3.5 kg | 6 |
| 1955230 | Microburst® 3000 Dispenser with LumeCel™ Technology — Chrome | 4.75" w x 8" h x 5" l | 7.8 lb | 12.06 cm x 20.32 cm x 12.7 cm | 3.5 kg | 6 |

UTILITY REFUSE AND RECYCLING

DECORATIVE REFUSE

CLEANING

MATERIAL HANDLING

WASHROOM

FOODSERVICE

ACCESSORIES & INDEX

Microburst® 3000 Aerosol Odor Control Systems

Delivering a cost-effective solution, with all the power, performance, and flexibility in half the size of standard dispensers, 3,000 sprays per refill. Smaller refills require less storage space and produce less waste.



BATTERY GAUGE
Shows battery life; battery lasts up to 36 months*
3000 – 2 C Cell
9000 – 2 D Cell

ALARM SYMBOL
Optional audio tone indicates need to change batteries and refill.

MICROBURST® 3000 SYSTEM
Combines great looks with low-cost, effective performance.

REFILL INDICATOR
Shows days remaining before refills need to be changed; refills last up to 168 days for 3000 dispensers, and up to 180 days for 9000 dispensers.

FLEXIBLE PROGRAMMING
Options include 12 / 24 hours per day and 5, 6, or 7 days per week.



Microburst® 3000 Dispensers*

| NO. | DESCRIPTION | U.S. DIMENSIONS | U.S. SHIP WT/CASE | U.S. CASE CUBE | METRIC DIMENSIONS | METRIC SHIP WT/CASE | METRIC CASE CUBE | CASE PACK |
|----------|---|-------------------|-------------------|----------------|--------------------|---------------------|------------------|-----------|
| 1793531 | Microburst® 3000 LCD Dispenser — Black | 3.25" w x 6.63" h | 6.0 lb | 0.28 ft³ | 8.26 cm x 16.83 cm | 2.7 kg | 0.09 m³ | 6 |
| 1793532 | Microburst® 3000 LCD Dispenser — White | 3.25" w x 6.63" h | 6.0 lb | 0.28 ft³ | 8.26 cm x 16.83 cm | 2.7 kg | 0.09 m³ | 6 |
| 1793533 | Microburst® 3000 LCD Dispenser — Chrome | 3.25" w x 6.63" h | 6.0 lb | 0.28 ft³ | 8.26 cm x 16.83 cm | 2.7 kg | 0.09 m³ | 6 |
| FG401442 | Microburst® 3000 Economizer Dispenser — White | 3.25" w x 6.63" h | 6.0 lb | 0.28 ft³ | 8.26 cm x 16.83 cm | 2.7 kg | 0.09 m³ | 6 |

*Requires 2 "C" alkaline batteries (not included)

Microburst® 3000 Refills

Microtrans® Odor Neutralizer breaks down and eliminates malodors.

- Contains 63% fewer VOCs per spray than a standard aerosol
- Refill actuator distributes the finest dry mist for long-lasting performance
- All refills contain Microtrans® Odor Neutralizer



FG4012551 FG4012561 FG4012571 FG4012591 FG4012581

Microburst® 3000 Refills*

| NO. | DESCRIPTION | FRAGRANCE FAMILY | U.S. SHIP WT/CASE | U.S. CASE CUBE | METRIC SHIP WT/CASE | METRIC CASE CUBE | CASE PACK |
|------------|--|------------------|-------------------|----------------|---------------------|------------------|-----------|
| FG4012551 | Microburst® 3000 Refill — Linen Fresh™ | Fougère | 3.0 lb | 0.14 ft³ | 1.4 kg | 0.04 m³ | 12 |
| FG4012561 | Microburst® 3000 Refill — Orchard Fields | Fruity | 3.0 lb | 0.14 ft³ | 1.4 kg | 0.04 m³ | 12 |
| FG4012571 | Microburst® 3000 Refill — Mountain Peaks | Fruity | 3.0 lb | 0.14 ft³ | 1.4 kg | 0.04 m³ | 12 |
| FG4012591 | Microburst® 3000 Refill — Country Delight™ | Floral | 3.0 lb | 0.14 ft³ | 1.4 kg | 0.04 m³ | 12 |
| FG4012581 | Microburst® 3000 Refill — Ocean Breeze | Herbal | 3.0 lb | 0.14 ft³ | 1.4 kg | 0.04 m³ | 12 |
| FG401689 | Microburst® 3000 Refill — Cinnamon Spice | Gourmand | 3.0 lb | 0.14 ft³ | 1.4 kg | 0.04 m³ | 12 |
| FG401690 | Microburst® 3000 Refill — Mango | Fruity | 3.0 lb | 0.14 ft³ | 1.4 kg | 0.04 m³ | 12 |
| FG401691 | Microburst® 3000 Refill — Vanilla Royale | Gourmand | 3.0 lb | 0.14 ft³ | 1.4 kg | 0.04 m³ | 12 |
| FG402355 | Microburst® 3000 Refill — Blue Splash | Fougère | 3.0 lb | 0.14 ft³ | 1.4 kg | 0.04 m³ | 12 |
| FG402408 | Microburst® 3000 Refill — Mandarin Orange | Citrus | 3.0 lb | 0.14 ft³ | 1.4 kg | 0.04 m³ | 12 |
| FG750362 | Microburst® 3000 Refill — Green Tea | Citrus | 3.0 lb | 0.14 ft³ | 1.4 kg | 0.04 m³ | 12 |
| FG750363 | Microburst® 3000 Refill — Cucumber Melon | Fruity | 3.0 lb | 0.14 ft³ | 1.4 kg | 0.04 m³ | 12 |
| FG401260A* | Microburst® 3000 Refill — Preference Pack | — | 3.0 lb | 0.14 ft³ | 1.4 kg | 0.04 m³ | 1 (10) |

*401260A Preference Pack contains 2 refills each of Linen Fresh™, Orchard Fields, Mountain Peaks, Country Delight™, and Ocean Breeze.



Microburst® 9000 Dispensers and Refills

The lowest cost in-use odor control system available. Microburst® refills contain 63 percent fewer VOCs per spray than a standard aerosol.

- The patented refill actuator distributes the finest dry mist for long lasting performance. The Microburst® 9000 system maximizes cost control while providing greater coverage and long-lasting odor neutralizing and fragrancing
- One 9000 refill will replace 3 standard aerosol refills
- All of the features of Microburst® 3000, but delivers three times the odor control and fragrance



LCD Programming options
 up to 180 days
 12 / 24 hr
 5 / 6 / 7 days per week

Economizer Programming options
 90 days
 24 hr
 7 days per week



1793535

MICROBURST® 9000 SYSTEM

Maximizes cost control while providing greater coverage and long-lasting odor neutralizing and fragrances.



1793534

1793535

Microburst® 9000 Dispensers*

| NO. | DESCRIPTION | U.S. DIMENSIONS | U.S. SHIP WT/CASE | U.S. CASE CUBE | METRIC DIMENSIONS | METRIC SHIP WT/CASE | METRIC CASE CUBE | CASE PACK |
|----------|---|-------------------|-------------------|----------------|--------------------|---------------------|------------------|-----------|
| 1793534 | Microburst® 9000 LCD Dispenser — Black | 3.56" w x 8.75" h | 7.0 lb | 0.46 ft³ | 9.04 cm x 22.23 cm | 3.2 kg | 0.14 m³ | 6 |
| 1793535 | Microburst® 9000 LCD Dispenser — White | 3.56" w x 8.75" h | 7.0 lb | 0.46 ft³ | 9.04 cm x 22.23 cm | 3.2 kg | 0.14 m³ | 6 |
| 1793536 | Microburst® 9000 LCD Dispenser — Chrome | 3.56" w x 8.75" h | 7.0 lb | 0.46 ft³ | 9.04 cm x 22.23 cm | 3.2 kg | 0.14 m³ | 6 |
| FG401375 | Microburst® 9000 Economizer Dispenser — White | 3.56" w x 8.75" h | 7.0 lb | 0.46 ft³ | 9.04 cm x 22.23 cm | 3.2 kg | 0.14 m³ | 6 |

*Requires 2 "D" alkaline batteries (not included).

Microburst® 9000 Refills

Microtrans® Odor Neutralizer breaks down and eliminates malodors.

- Contains 63% fewer VOCs per spray than a standard aerosol
- Refill actuator distributes the finest dry mist for long-lasting performance

**9000
METERED
SPRAYS**



DELIVERING COST EFFECTIVE CUSTOMER DELIGHT

One 9000 refill will replace three standard refills – 90 to 180 days of maximum odor control from one refill. This also allows for less packaging per spray.

Microburst® 9000 Refills

| NO. | DESCRIPTION | FRAGRANCE FAMILY | U.S. SHIP WT/CASE | U.S. CASE CUBE | METRIC SHIP WT/CASE | METRIC CASE CUBE | CASE PACK |
|------------|--|------------------|-------------------|----------------|---------------------|------------------|-----------|
| FG4012441 | Microburst® 9000 Refill — Linen Fresh™ | Fougère | 3.0 lb | 0.16 ft³ | 1.4 kg | 0.05 m³ | 4 |
| FG4012451 | Microburst® 9000 Refill — Orchard Fields | Fruity | 3.0 lb | 0.16 ft³ | 1.4 kg | 0.05 m³ | 4 |
| FG4012461 | Microburst® 9000 Refill — Mountain Peaks | Fruity | 3.0 lb | 0.16 ft³ | 1.4 kg | 0.05 m³ | 4 |
| FG4012481 | Microburst® 9000 Refill — Country Delight™ | Floral | 3.0 lb | 0.16 ft³ | 1.4 kg | 0.05 m³ | 4 |
| FG4012471 | Microburst® 9000 Refill — Ocean Breeze | Herbal | 3.0 lb | 0.16 ft³ | 1.4 kg | 0.05 m³ | 4 |
| FG401692 | Microburst® 9000 Refill — Cinnamon Spice | Gourmand | 3.0 lb | 0.16 ft³ | 1.4 kg | 0.05 m³ | 4 |
| FG401693 | Microburst® 9000 Refill — Mango | Fruity | 3.0 lb | 0.16 ft³ | 1.4 kg | 0.05 m³ | 4 |
| FG401694 | Microburst® 9000 Refill — Vanilla Royale | Gourmand | 3.0 lb | 0.16 ft³ | 1.4 kg | 0.05 m³ | 4 |
| FG402354 | Microburst® 9000 Refill — Blue Splash | Fougère | 3.0 lb | 0.16 ft³ | 1.4 kg | 0.05 m³ | 4 |
| FG402093 | Microburst® 9000 Refill — Mandarin Orange | Citrus | 3.0 lb | 0.16 ft³ | 1.4 kg | 0.05 m³ | 4 |
| FG750366 | Microburst® 9000 Refill — Cucumber Melon | Fruity | 3.0 lb | 0.16 ft³ | 1.4 kg | 0.05 m³ | 4 |
| FG4012491* | Microburst® 9000 Refill — Preference Pack | — | 4.0 lb | 0.16 ft³ | 1.8 kg | 0.05 m³ | 1 (5) |

*4012491 Preference Pack contains 1 refill each of Linen Fresh™, Orchard Fields, Mountain Peaks, Country Delight™, and Ocean Breeze.

Microburst® Duet Dispensers and Refills

Dual-fragrance odor control system.

- Automatically alternates between two complementary scents for renewed freshness you will notice every day

2 fragrances are better than **1**

DUAL FRAGRANCES

Alternates between two complementary scents, eliminates fragrance fatigue, and keeps rooms fresh and pleasant.

Year Warranty **10**

Fully Guaranteed Against Defects in Parts and Workmanship



FG4870055

DISPENSER LOCK



FLEXIBLE PROGRAMMING

You decide which fragrance will spray, and when. Alternates fragrances:

- Hour to Hour
- AM / PM
- Day to Day



63%

fewer VOCs per spray than standard aerosol

Microburst® Duet Dispensers

Dual-fragrance odor control system.

- Alternating scents eliminate fragrance fatigue
- Programmable freshness
- Cost-effective solution
- High-quality, customer-preferred refill fragrances
- Use with Microburst® Duet Refills
- Requires 2 "C" alkaline batteries (not included)



FG4870001



FG4870002



FG4870055



FG4870056

Microburst® Duet Dispensers

| NO. | DESCRIPTION | U.S. DIMENSIONS | U.S. SHIP WT/CASE | U.S. CASE CUBE | METRIC DIMENSIONS | METRIC SHIP WT/CASE | METRIC CASE CUBE | CASE PACK |
|-----------|--|-------------------|-------------------|----------------|--------------------|---------------------|------------------|-----------|
| FG4870001 | Microburst® Duet Dispenser – White/Grey Pearl | 4.96" w x 8.62" h | 24.8 lb | 2.36 ft³ | 12.6 cm x 21.89 cm | 11.2 kg | 0.072 m³ | 6 |
| FG4870002 | Microburst® Duet Dispenser – Black/Black Pearl | 4.96" w x 8.62" h | 24.8 lb | 2.36 ft³ | 12.6 cm x 21.89 cm | 11.2 kg | 0.072 m³ | 6 |
| FG4870055 | Microburst® Duet Dispenser – Black/Chrome | 4.96" w x 8.62" h | 24.8 lb | 2.36 ft³ | 12.6 cm x 21.89 cm | 11.2 kg | 0.072 m³ | 6 |
| FG4870056 | Microburst® Duet Dispenser – White/White | 4.96" w x 8.62" h | 24.8 lb | 2.36 ft³ | 12.6 cm x 21.89 cm | 11.2 kg | 0.072 m³ | 6 |

Microburst® Duet Refills

Specially selected complementary fragrances.

- Each refill features a unique combination of exclusive aromas
- High-quality fragrance oils dispensed through Microburst® technology for longer-lasting performance
- All refills contain Microtrans® odor neutralizer
- Use with Microburst® Duet dispensers



Gentle Breeze / Linen Fresh™
3485949



Alpine Spring / Mountain Peaks
3485950



Ocean Breeze / Sea Mist
3485951



Cotton Berry / Refreshing Citrus
3485952

Microburst® Duet Refills

| NO. | DESCRIPTION | FRAGRANCE FAMILY | U.S. SHIP WT/CASE | U.S. CASE CUBE | METRIC SHIP WT/CASE | METRIC CASE CUBE | CASE PACK |
|---------|---|------------------|-------------------|----------------|---------------------|------------------|-----------|
| 3485949 | Microburst® Duet – Gentle Breeze/Linen Fresh™ | Fruity/Fougere | 10.85 lb | 0.024 ft³ | 4.9 kg | 0.01 m³ | 4 |
| 3485950 | Microburst® Duet – Alpine Spring/Mountain Peaks | Fougere/Fruity | 10.85 lb | 0.024 ft³ | 4.9 kg | 0.01 m³ | 4 |
| 3485951 | Microburst® Duet – Ocean Breeze/Sea Mist | Floral/Herbal | 10.85 lb | 0.024 ft³ | 4.9 kg | 0.01 m³ | 4 |
| 3485952 | Microburst® Duet – Cotton Berry/Refreshing Citrus | Floral/Citrus | 10.85 lb | 0.024 ft³ | 4.9 kg | 0.01 m³ | 4 |
| 3486092 | Microburst® Duet – Variety Pack (1 of ea. refill) | – | 10.85 lb | 0.024 ft³ | 4.9 kg | 0.01 m³ | 1 (4) |



UTILITY REFUSE AND RECYCLING

DECORATIVE REFUSE

CLEANING

MATERIAL HANDLING

WASHROOM

FOODSERVICE

ACCESSORIES & INDEX

Standard Aerosol Dispensers and Refills

Standard Aerosol System offers automatic odor control for every budget.

- Smart chip technology maximizes odor control effectiveness for 30 to 168 days
- LCD model features adjustable spray intervals of 7, 14, or 28 minutes; 12/24 hours per day; or 5, 6, or 7 days per week
- LED model features adjustable spray intervals from 5 to 25 minutes and service intervals of 30, 45, or 60 days
- All refills contain Microtrans® Odor Neutralizer



1793541

Standard Aerosol System Dispensers

| NO. | DESCRIPTION | U.S. DIMENSIONS | U.S. SHIP WT/CASE | U.S. CASE CUBE | METRIC DIMENSIONS | METRIC SHIP WT/CASE | METRIC CASE CUBE | CASE PACK |
|----------|--|-------------------|-------------------|----------------|--------------------|---------------------|------------------|-----------|
| 1793541 | Standard Aerosol LCD Dispenser — White | 3.56" w x 8.75" h | 7.0 lb | 0.46 ft³ | 9.04 cm x 22.23 cm | 3.2 kg | 0.14 m³ | 6 |
| FG400868 | Standard Aerosol Economizer — White | 3.56" w x 8.75" h | 7.0 lb | 0.46 ft³ | 9.04 cm x 22.23 cm | 3.2 kg | 0.14 m³ | 6 |

*Requires 2 "D" alkaline batteries (not included)



FG4009831 / FG4015471 / FG4009851 / FG4009841 / FG4015061

Standard Aerosol System Refills

| NO. | DESCRIPTION | FRAGRANCE FAMILY | U.S. SHIP WT/CASE | U.S. CASE CUBE | METRIC SHIP WT/CASE | METRIC CASE CUBE | CASE PACK |
|-----------|-------------------------------------|------------------|-------------------|----------------|---------------------|------------------|-----------|
| FG4009831 | Standard Aerosol — Linen Fresh™ | Fougère | 9.0 lb | 0.31 ft³ | 4.1 kg | 0.09 m³ | 12 |
| FG4009841 | Standard Aerosol — Orchard Fields | Fruity | 9.0 lb | 0.31 ft³ | 4.1 kg | 0.09 m³ | 12 |
| FG4009851 | Standard Aerosol — Mountain Peaks | Fruity | 9.0 lb | 0.31 ft³ | 4.1 kg | 0.09 m³ | 12 |
| FG4015061 | Standard Aerosol — Country Delight™ | Floral | 9.0 lb | 0.31 ft³ | 4.1 kg | 0.09 m³ | 12 |
| FG4015471 | Standard Aerosol — Ocean Breeze | Herbal | 9.0 lb | 0.31 ft³ | 4.1 kg | 0.09 m³ | 12 |
| FG400573 | Standard Aerosol — Vanilla Royale | Gourmand | 9.0 lb | 0.31 ft³ | 4.1 kg | 0.09 m³ | 12 |
| FG400696 | Standard Aerosol — Cinnamon Spice | Gourmand | 9.0 lb | 0.31 ft³ | 4.1 kg | 0.09 m³ | 12 |
| FG401503 | Standard Aerosol — Delicious Apple | Fruity | 9.0 lb | 0.31 ft³ | 4.1 kg | 0.09 m³ | 12 |
| FG401504 | Standard Aerosol — Mandarin Orange | Citrus | 9.0 lb | 0.31 ft³ | 4.1 kg | 0.09 m³ | 12 |
| FG401695 | Standard Aerosol — Mango | Fruity | 9.0 lb | 0.31 ft³ | 4.1 kg | 0.09 m³ | 12 |
| FG401909 | Standard Aerosol — Lemon | Citrus | 9.0 lb | 0.31 ft³ | 4.1 kg | 0.09 m³ | 12 |
| FG401231* | Standard Aerosol — Preference Pack | — | 8.5 lb | 0.31 ft³ | 3.9 kg | 0.09 m³ | 1 (10) |

*401260A Preference Pack contains 2 refills each of Linen Fresh™, Orchard Fields, Mountain Peaks, Country Delight™, and Ocean Breeze.

TCell™ 1.0 Dispensers and Refills

Utilizing its patented fluid delivery system, TCell™ fuel cell technology delivers a precise dose of a wide variety of fragrances for 60 or 90 days without the use of batteries. Environmentally friendly system contains no propellants or added VOCs.

- Precision dosing delivery system; one dispenser covers approximately 3 to 4 stalls/fixtures (6,000 cubic feet)
- Sleek, attractive dispenser design will fit any décor
- Passive dispenser requires no batteries and operates silently



LIFETIME WARRANTY
Fully guaranteed against defects of parts and workmanship.



1793548

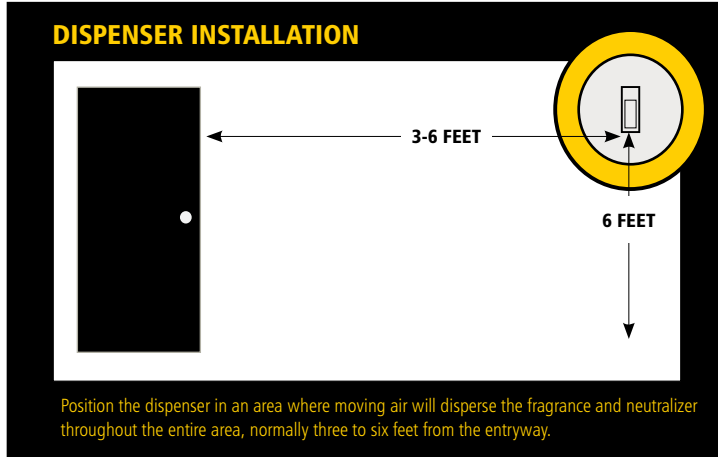

TCell™ Dispensers

| NO. | DESCRIPTION | U.S. DIMENSIONS | U.S. SHIP WT/CASE | U.S. CASE CUBE | METRIC DIMENSIONS | METRIC SHIP WT/CASE | METRIC CASE CUBE | CASE PACK |
|---------|---------------------------|------------------|-------------------|----------------|--------------------|---------------------|------------------|-----------|
| 1793546 | TCell™ Dispenser — Black | 2.8" w x 5.37" h | 3.5 lb | 0.44 ft³ | 7.11 cm x 13.63 cm | 1.6 kg | 0.13 m³ | 12 |
| 1793547 | TCell™ Dispenser — White | 2.8" w x 5.37" h | 3.5 lb | 0.44 ft³ | 7.11 cm x 13.63 cm | 1.6 kg | 0.13 m³ | 12 |
| 1793548 | TCell™ Dispenser — Chrome | 2.8" w x 5.37" h | 3.5 lb | 0.44 ft³ | 7.11 cm x 13.63 cm | 1.6 kg | 0.13 m³ | 12 |

TCell™ Refills

The TCell™ odor control system dispenses a consistent level of fragrance.

- Up to 33% refill source reduction over traditional 30 day systems
- Standard setting: 60 Days — Standard Size Washroom: 3 to 4 stalls/fixtures
- Light setting: 90 Days — Smaller Size Washroom: 1 to 2 stalls/fixtures
- Recyclable refill components



TCell™ Refills

| NO. | DESCRIPTION | FRAGRANCE FAMILY | U.S. SHIP WT/CASE | U.S. CASE CUBE | METRIC SHIP WT/CASE | METRIC CASE CUBE | CASE PACK |
|-----------|--|------------------|-------------------|----------------|---------------------|------------------|-----------|
| FG402110 | TCell™ Refill — Wakening Spring | Floral | 2.0 lb | 0.11 ft³ | 0.9 kg | 0.03 m³ | 6 |
| FG402111 | TCell™ Refill — Polar Mist | Herbal | 2.0 lb | 0.11 ft³ | 0.9 kg | 0.03 m³ | 6 |
| FG402112 | TCell™ Refill — Blue Splash | Fougère | 2.0 lb | 0.11 ft³ | 0.9 kg | 0.03 m³ | 6 |
| FG402187 | TCell™ Refill — Crystal Breeze | Herbal | 2.0 lb | 0.11 ft³ | 0.9 kg | 0.03 m³ | 6 |
| FG402113 | TCell™ Refill — Citrus | Citrus | 2.0 lb | 0.11 ft³ | 0.9 kg | 0.03 m³ | 6 |
| FG402369 | TCell™ Refill — Mango Blossom | Fruity | 2.0 lb | 0.11 ft³ | 0.9 kg | 0.03 m³ | 6 |
| FG402470 | TCell™ Refill — Cucumber Melon | Fruity | 2.0 lb | 0.11 ft³ | 0.9 kg | 0.03 m³ | 6 |
| FG402472 | TCell™ Refill — Tropical Sunrise | Fruity | 2.0 lb | 0.11 ft³ | 0.9 kg | 0.03 m³ | 6 |
| FG402473 | TCell™ Refill — Summer Sorbet | Floral | 2.0 lb | 0.11 ft³ | 0.9 kg | 0.03 m³ | 6 |
| FG402498 | TCell™ Refill — Pure™ Odor Neutralizer | — | 2.0 lb | 0.11 ft³ | 0.9 kg | 0.03 m³ | 6 |
| FG750905 | TCell™ Refill — Vanilla Crème | Gourmand | 2.0 lb | 0.11 ft³ | 0.9 kg | 0.03 m³ | 6 |
| FG750537 | TCell™ Refill — Sugar Cookie | Gourmand | 2.0 lb | 0.11 ft³ | 0.9 kg | 0.03 m³ | 6 |
| FG750907 | TCell™ Refill — Cinnamon Spice | Gourmand | 2.0 lb | 0.11 ft³ | 0.9 kg | 0.03 m³ | 6 |
| FG402236* | TCell™ Refill Preference Pack | — | 2.0 lb | 0.11 ft³ | 0.9 kg | 0.03 m³ | 1 (5) |

*FG402236 Preference Pack contains one refill each of Wakening Spring, Polar Mist, Blue Splash, Citrus, and Crystal Breeze.



AutoFaucet®

AutoFaucet® sets the standard for reliability and user-friendly performance in automated faucet systems. Equipped with Surround Sensor™ Technology, AutoFaucet® delivers water only when needed, resulting in water savings of up to 70 percent.

- Touch-free activation eliminates cross-contamination to help reduce the spread of germs
- Surround Sensor™ technology creates a 3" omnidirectional sensing zone, guaranteeing activation every time
- AutoFaucet® is low-lead-compliant
- "Dry" cam-gear technology (solenoid valve-free) ensures trouble-free operation to reduce maintenance
- Long battery life—400,000 cycles or 3 years (4 "D" batteries included)
- Also available with optional AC power adapter
- Standard 0.5 gpm aerator helps conserve water and reduce negative impact on the environment



ADA COMPLIANT



Certified by IAMPO R&T for compliance with Lead Plumbing Law

UP TO
70%
water savings



Surround Sensor™ Technology creates a 3" omnidirectional sensing zone, guaranteeing activation every time.



MILANO



VERONA

UTILITY REFUSE AND RECYCLING

DECORATIVE REFUSE

CLEANING

MATERIAL HANDLING

WASHROOM

FOODSERVICE

ACCESSORIES & INDEX



Improve Health & Wellness

Away-from-home washroom patrons prefer touch-free fixtures and are 50% more likely to wash their hands. AutoFaucet® effortlessly provides reliable, touch-free activation every time to encourage, rather than discourage, frequent use and to eliminate this critical touch point of germs in washrooms.



Sustainable Design

AutoFaucet® delivers water only when needed to save up to 70% water savings and earn LEED credits. AutoFaucet® systems' dry cam-gear technology requires less energy to operate, providing exceptional battery life for over 400,000 hand washes (AC power option available).



World-Class Reliability

Patented dry cam-gear technology controls water flow with world-class reliability. The absence of solenoid valves avoids costly repairs and ensures worry-free operation by keeping electronic components separate from water flow.

OPTIONAL THERMOSTATIC MIXING VALVE

Guarantees that water temperature remains in the desired range

SCAN FOR
INSTALLATION
INSTRUCTIONS



VENETIAN
DECK-MOUNTED

Year Warranty
3

Fully Guaranteed
Against Defects in
Parts and Workmanship

All models come supplied with an auto open line purge feature that eliminates stagnant water and bacterial growth.



UTILITY REFUSE
AND RECYCLING

DECORATIVE REFUSE

CLEANING

MATERIAL HANDLING

WASHROOM

FOODSERVICE

ACCESSORIES
& INDEX

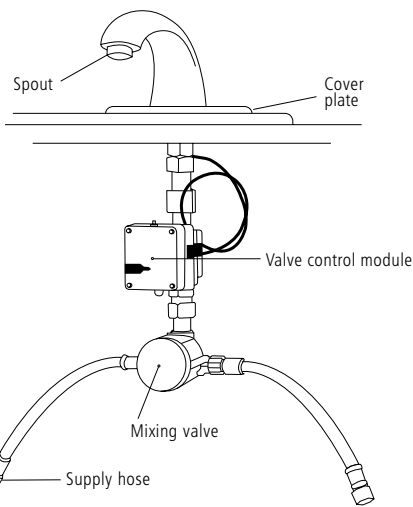

Certified by IAPMO R&T for compliance with Lead Plumbing Law





MILANO



VERONA



VENETIAN

| | Finish | Single Hole Mount | 4" Center Set | 8" Center Set | Flow Rate (GPM) | Valve Control Module | Main Supply Hose | Mixing Valve | Thermostatic Mixing Valve | Hot/Cold Supply Hoses |
|--|----------------------|-------------------|---------------|---------------|-----------------|----------------------|------------------|--------------|---------------------------|-----------------------|
| MILANO  | Polished Chrome | 1903286 | 1903288 | 1903291 | 1.5 aerated | ● | | | | |
| | Polished Chrome | 1903287 | 1903289 | 1903290 | 1.5 aerated | ● | ● | | | |
| | Polished Chrome | 1782742 | 1782743 | 1782744 | 1.5 aerated | ● | | ● | | ● |
| | Polished Chrome | 1818966 | 1818967 | 1818968 | 1.5 aerated | ● | | | ● | ● |
| VERONA  | Polished Chrome | 1903281 | | | 1.5 aerated | ● | | | ● | ● |
| VENETIAN  | Polished Chrome 5.5" | FG750353 | FG750354 | FG750355 | 2.2 laminar | ● | | | ● | ● |

AutoFaucet® Single Hole Mounts

| NO. | DESCRIPTION | U.S. DIMENSIONS | U.S. SHIP WT/CASE | U.S. CASE CUBE | METRIC DIMENSIONS | METRIC SHIP WT/CASE | METRIC CASE CUBE | KIT | CASE PACK |
|----------|----------------------------------|------------------------------|-------------------|----------------------|------------------------------|---------------------|---------------------|-----|-----------|
| 1903286 | Milano in Polished Chrome | 6.50" l x 2.13" w x 3.75" h | 6.0 lb | 0.26 ft ³ | 16.5 cm x 5.4 cm x 9.5 cm | 2.72 kg | 0.01 m ³ | 1 | 1 |
| 1903287 | Milano in Polished Chrome | 6.50" l x 2.13" w x 3.75" h | 6.0 lb | 0.26 ft ³ | 16.5 cm x 5.4 cm x 9.5 cm | 2.72 kg | 0.01 m ³ | 2 | 1 |
| 1818966 | Milano in Polished Chrome | 6.50" l x 2.13" w x 3.75" h | 6.0 lb | 0.26 ft ³ | 16.5 cm x 5.4 cm x 9.5 cm | 2.72 kg | 0.01 m ³ | 4 | 1 |
| 1782742 | Milano in Polished Chrome | 6.50" l x 2.13" w x 3.75" h | 7.0 lb | 0.26 ft ³ | 16.5 cm x 5.4 cm x 9.5 cm | 3.18 kg | 0.01 m ³ | 6 | 1 |
| 1903281 | Verona in Polished Chrome | 6.75" l x 2.50" w x 5.00" h | 6.0 lb | 0.26 ft ³ | 17.15 cm x 6.35 cm x 8.89 cm | 2.72 kg | 0.01 m ³ | 4 | 1 |
| FG750353 | Venetian 5.5" in Polished Chrome | 7.63" l x 2.00" w x 10.00" h | 7.0 lb | 0.26 ft ³ | 19.38 cm x 5.08 cm x 25.4 cm | 3.18 kg | 0.01 m ³ | 4 | 1 |

*Supplied with 1.5 GPM (5.7 L/min.) laminar flow; can be ordered with Flow Control Aerator that delivers 0.5 GPM, 1.0 GPM, 1.5 GPM, 2.0 GPM, or 2.2 GPM.

AutoFaucet® 4" Center Sets

| NO. | DESCRIPTION | U.S. DIMENSIONS | U.S. SHIP WT/CASE | U.S. CASE CUBE | METRIC DIMENSIONS | METRIC SHIP WT/CASE | METRIC CASE CUBE | KIT | CASE PACK |
|----------|--------------------------------------|------------------------------|-------------------|----------------------|------------------------------|---------------------|---------------------|-----|-----------|
| 1903288 | Milano in Polished Chrome | 6.50" l x 2.13" w x 3.75" h | 7.0 lb | 0.26 ft ³ | 16.5 cm x 5.4 cm x 9.5 cm | 3.18 kg | 0.01 m ³ | 1 | 1 |
| 1903289 | Milano in Polished Chrome | 6.50" l x 2.13" w x 3.75" h | 7.0 lb | 0.26 ft ³ | 16.5 cm x 5.4 cm x 9.5 cm | 3.18 kg | 0.01 m ³ | 2 | 1 |
| 1782743 | Milano in Polished Chrome (Low Lead) | 6.50" l x 2.13" w x 3.75" h | 7.0 lb | 0.26 ft ³ | 16.5 cm x 5.4 cm x 9.5 cm | 3.18 kg | 0.01 m ³ | 3 | 1 |
| 1818967 | Milano in Polished Chrome | 6.50" l x 2.13" w x 3.75" h | 7.0 lb | 0.26 ft ³ | 16.5 cm x 5.4 cm x 9.5 cm | 3.18 kg | 0.01 m ³ | 4 | 1 |
| FG750354 | Venetian 5.5" in Polished Chrome | 7.63" l x 2.00" w x 10.00" h | 7.0 lb | 0.26 ft ³ | 19.38 cm x 5.08 cm x 25.4 cm | 3.18 kg | 0.01 m ³ | 4 | 1 |

AutoFaucet® 8" Center Sets

| NO. | DESCRIPTION | U.S. DIMENSIONS | U.S. SHIP WT/CASE | U.S. CASE CUBE | METRIC DIMENSIONS | METRIC SHIP WT/CASE | METRIC CASE CUBE | KIT | CASE PACK |
|----------|--------------------------------------|------------------------------|-------------------|----------------------|------------------------------|---------------------|---------------------|-----|-----------|
| 1903291 | Milano in Polished Chrome | 6.50" l x 2.13" w x 3.75" h | 7.0 lb | 0.26 ft ³ | 16.5 cm x 5.4 cm x 9.5 cm | 3.18 kg | 0.01 m ³ | 1 | 1 |
| 1903290 | Milano in Polished Chrome | 6.50" l x 2.13" w x 3.75" h | 7.0 lb | 0.26 ft ³ | 16.5 cm x 5.4 cm x 9.5 cm | 3.18 kg | 0.01 m ³ | 2 | 1 |
| 1782744 | Milano in Polished Chrome (Low Lead) | 6.50" l x 2.13" w x 3.75" h | 7.0 lb | 0.26 ft ³ | 16.5 cm x 5.4 cm x 9.5 cm | 3.18 kg | 0.01 m ³ | 3 | 1 |
| 1818968 | Milano in Polished Chrome | 6.50" l x 2.13" w x 3.75" h | 7.0 lb | 0.26 ft ³ | 16.5 cm x 5.4 cm x 9.5 cm | 3.18 kg | 0.01 m ³ | 4 | 1 |
| FG750355 | Venetian 5.5" Polished Chrome | 7.63" l x 2.00" w x 10.00" h | 7.0 lb | 0.26 ft ³ | 19.38 cm x 5.08 cm x 25.4 cm | 3.18 kg | 0.01 m ³ | 4 | 1 |

Kit 1 Includes: spout and valve control module

Kit 2 Includes: spout, valve control module, and main supply hose (1/2" pipe x 3/8" comp. x 12" length)

Kit 3 Includes: spout, valve control module, mixing valve, and hot/cold supply hoses (3/8" comp. x 3/8" comp. x 12" length)

Kit 4 Includes: spout, valve control module, thermostatic mixing valve, and hot/cold supply hoses (3/8" comp. x 3/8" comp. x 12" length)

Kit 5 Includes: spout, valve control module, mixing valve, and hot/cold supply hoses (3/8" comp. x 1/2" comp. x 12" length)

Kit 6 Includes: 0.5 GPM spout, valve control module, mixing valve, and hot/cold supply hoses (3/8" comp. x 3/8" comp. x 12" length)



UTILITY REFUSE
AND RECYCLING

DECORATIVE REFUSE

CLEANING

MATERIAL HANDLING

WASHROOM

FOODSERVICE

ACCESSORIES
& INDEX

Auto Flush®

Touch-free, cost-effective flushing systems for high traffic washrooms.

- Smart Object Infrared Technology manages flushing automation for world-class reliability
- Promotes good hygiene by eliminating potential points of cross-contamination
- Prevents odors by ensuring that fixtures are flushed after every use
- No water shutoff is required during installation
- Auto Flush® Systems are available for toilets and urinals
- Installs in minutes



Simply slides over existing handle



Auto Flush® Sidemount

Sidemount style allows for easy installation by replacing current flush handle.

- Easy installation automates flush handles in minutes
- Eliminates source of odor
- Battery reserve feature allows 9,000 flushes after low battery indicator begins flashing
- Angled lens design combined with advanced sensor technology guarantees activation even with the toilet seat raised
- Toilet and urinal models available; toilet model has courtesy flush button
- Long battery life, 3+ years or up to 100,000 flushes (4 "C" batteries included)



FG401186A



FG401187A

Auto Flush® Clamp

Clamp style allows for easy installation directly over current flush handle.

- Easy installation automates flush handles in minutes.
- Eliminates source of odor
- Battery reserve feature allows 9,000 flushes after low battery indicator begins flashing
- Angled lens design combined with advanced sensor technology guarantees activation even with the toilet seat raised
- Toilet and urinal models available; toilet model has courtesy flush button
- Long battery life, 3+ years or up to 60,000 flushes (4 "C" batteries included)



FG401804A
Urinal



FG401805A
Toilet

SCAN FOR
INSTALLATION
VIDEOS



SCAN FOR
INSTALLATION
VIDEOS



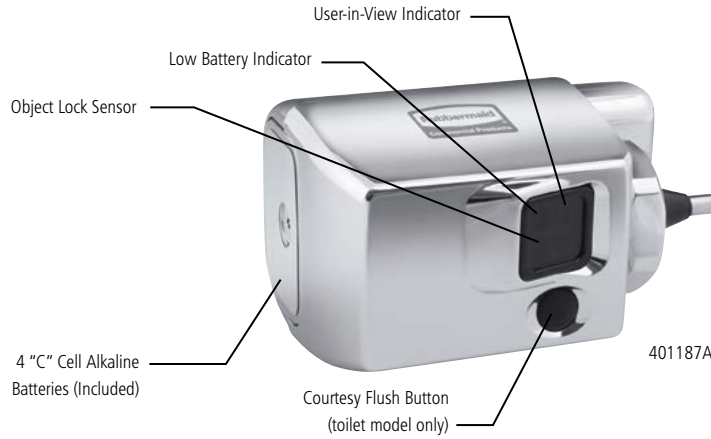

Auto Flush® Urinals

| NO. | DESCRIPTION | U.S. DIMENSIONS | U.S. SHIP WT/CASE | U.S. CASE CUBE | METRIC DIMENSIONS | METRIC SHIP WT/CASE | METRIC CASE CUBE | CASE PACK |
|-----------|--|------------------------------|-------------------|----------------|-----------------------------|---------------------|------------------|-----------|
| FG401804A | Auto Flush® Clamp Polished Chrome Urinal | 5.313" l x 3.56" w x 3.63" h | 1.5 lb | 0.14 ft³ | 13.5 cm x 9.04 cm x 9.22 cm | 0.68 kg | 0.004 m³ | 1 |
| FG402060A | Auto Flush® Clamp Polished Chrome Urinal - Metal | 5.313" l x 3.56" w x 3.63" h | 1.5 lb | 0.14 ft³ | 13.5 cm x 9.04 cm x 9.22 cm | 0.68 kg | 0.004 m³ | 1 |

Auto Flush® Urinals (for Sloan or Zurn flush valves)

| NO. | DESCRIPTION | U.S. DIMENSIONS | U.S. SHIP WT/CASE | U.S. CASE CUBE | METRIC DIMENSIONS | METRIC SHIP WT/CASE | METRIC CASE CUBE | CASE PACK |
|-----------|--|-----------------------------|-------------------|----------------|---------------------------|---------------------|------------------|-----------|
| FG401186A | Auto Flush® Sidemount Polished Chrome Urinal | 4.75" l x 3.30" w x 2.80" h | 2.3 lb | 0.15 ft³ | 12 cm x 8.38 cm x 7.11 cm | 1.04 kg | 0.004 m³ | 1 |
| FG401982 | Auto Flush® Sidemount Polished Chrome Urinal — Metal | 4.75" l x 3.30" w x 2.80" h | 2.3 lb | 0.15 ft³ | 12 cm x 8.38 cm x 7.11 cm | 1.04 kg | 0.004 m³ | 1 |

Auto Flush® Urinal (for Coyne & Delany Flushboy valves)

| NO. | DESCRIPTION | U.S. DIMENSIONS | U.S. SHIP WT/CASE | U.S. CASE CUBE | METRIC DIMENSIONS | METRIC SHIP WT/CASE | METRIC CASE CUBE | CASE PACK |
|-----------|--|-----------------------------|-------------------|----------------|---------------------------|---------------------|------------------|-----------|
| FG401207A | Auto Flush® Sidemount Polished Chrome Urinal | 4.75" l x 3.30" w x 2.80" h | 2.3 lb | 0.15 ft³ | 12 cm x 8.38 cm x 7.11 cm | 1.04 kg | 0.004 m³ | 1 |

Auto Flush® Toilets

| NO. | DESCRIPTION | U.S. DIMENSIONS | U.S. SHIP WT/CASE | U.S. CASE CUBE | METRIC DIMENSIONS | METRIC SHIP WT/CASE | METRIC CASE CUBE | CASE PACK |
|-----------|--|------------------------------|-------------------|----------------|-----------------------------|---------------------|------------------|-----------|
| FG401805A | Auto Flush® Clamp Polished Chrome Toilet | 5.313" l x 3.56" w x 3.63" h | 1.5 lb | 0.14 ft³ | 13.5 cm x 9.04 cm x 9.22 cm | 0.68 kg | 0.004 m³ | 1 |
| FG402059A | Auto Flush® Clamp Polished Chrome Toilet — Metal | 5.313" l x 3.56" w x 3.63" h | 1.5 lb | 0.14 ft³ | 13.5 cm x 9.04 cm x 9.22 cm | 0.68 kg | 0.004 m³ | 1 |

Auto Flush® Toilets (for Sloan or Zurn flush valves)

| NO. | DESCRIPTION | U.S. DIMENSIONS | U.S. SHIP WT/CASE | U.S. CASE CUBE | METRIC DIMENSIONS | METRIC SHIP WT/CASE | METRIC CASE CUBE | CASE PACK |
|-----------|--|-----------------------------|-------------------|----------------|---------------------------|---------------------|------------------|-----------|
| FG401187A | Auto Flush® Sidemount Polished Chrome Toilet | 4.75" l x 3.30" w x 2.80" h | 2.3 lb | 0.15 ft³ | 12 cm x 8.38 cm x 7.11 cm | 1.04 kg | 0.004 m³ | 1 |
| FG401981 | Auto Flush® Sidemount Polished Chrome Toilet — Metal | 4.75" l x 3.30" w x 2.80" h | 2.3 lb | 0.15 ft³ | 12 cm x 8.38 cm x 7.11 cm | 1.04 kg | 0.004 m³ | 1 |

Auto Flush® Toilet (for Coyne & Delany Flushboy valves)

| NO. | DESCRIPTION | U.S. DIMENSIONS | U.S. SHIP WT/CASE | U.S. CASE CUBE | METRIC DIMENSIONS | METRIC SHIP WT/CASE | METRIC CASE CUBE | CASE PACK |
|-----------|--|-----------------------------|-------------------|----------------|---------------------------|---------------------|------------------|-----------|
| FG401206A | Auto Flush® Sidemount Polished Chrome Toilet | 4.75" l x 3.30" w x 2.80" h | 2.3 lb | 0.15 ft³ | 12 cm x 8.38 cm x 7.11 cm | 1.04 kg | 0.004 m³ | 1 |

Sidemount Adapters

| NO. | DESCRIPTION | U.S. DIMENSIONS | U.S. SHIP WT/CASE | U.S. CASE CUBE | METRIC DIMENSIONS | METRIC SHIP WT/CASE | METRIC CASE CUBE | CASE PACK |
|--------|-------------------------------------|-----------------------------|-------------------|----------------|---------------------------|---------------------|------------------|-----------|
| 401096 | Auto Flush® High Mount Adapter Kit | 4.75" l x 3.30" w x 2.80" h | 2.3 lb | 0.15 ft³ | 12 cm x 8.38 cm x 7.11 cm | 1.04 kg | 0.004 m³ | 1 |
| 401165 | Auto Flush® Crane Valve Adapter Kit | 4.75" l x 3.30" w x 2.80" h | 2.3 lb | 0.15 ft³ | 12 cm x 8.38 cm x 7.11 cm | 1.04 kg | 0.004 m³ | 1 |
| 401239 | Auto Flush® Teck Valve Adapter | 4.75" l x 3.30" w x 2.80" h | 2.3 lb | 0.15 ft³ | 12 cm x 8.38 cm x 7.11 cm | 1.04 kg | 0.004 m³ | 1 |
| 401477 | Auto Flush® Tempus Valve Adapter | 4.75" l x 3.30" w x 2.80" h | 2.3 lb | 0.15 ft³ | 12 cm x 8.38 cm x 7.11 cm | 1.04 kg | 0.004 m³ | 1 |

Clamp Adapters

| NO. | DESCRIPTION | U.S. DIMENSIONS | U.S. SHIP WT/CASE | U.S. CASE CUBE | METRIC DIMENSIONS | METRIC SHIP WT/CASE | METRIC CASE CUBE | CASE PACK |
|---------|--|------------------------------|-------------------|----------------|-----------------------------|---------------------|------------------|-----------|
| 401972 | Auto Flush® Coyne & Delany/Crane Rex Adapter Kit | 5.313" l x 3.56" w x 3.63" h | 1.5 lb | 0.14 ft³ | 13.5 cm x 9.04 cm x 9.22 cm | 0.68 kg | 0.004 m³ | 1 |
| 401973 | Auto Flush® Canadian Adapter Kit (Crane, Teck, Tempus) | 5.313" l x 3.56" w x 3.63" h | 1.5 lb | 0.14 ft³ | 13.5 cm x 9.04 cm x 9.22 cm | 0.68 kg | 0.004 m³ | 1 |
| 4870577 | Auto Flush® Power Adapter Kit | 5.313" l x 3.56" w x 3.63" h | 1.5 lb | 0.14 ft³ | 13.5 cm x 9.04 cm x 9.22 cm | 0.68 kg | 0.004 m³ | 1 |



AutoClean®

AutoClean® Systems deliver powerful formulas that attack and eliminate odors at the source—automatically cleaning fixture surfaces, day and night.

- Easy in-line installation allows cleaning solution to reach the hard to clean areas, such as rim holes, ensuring that the whole fixture is cleaned
- Refills deliver consistent metered dosage of Purinel® SC to prevent buildup of calcium on pipes and scaling
- Flexible programming options: up to 90-day refill cycle settings
- Industry-leading battery life of up to 3 years

SCAN FOR INSTALLATION VIDEOS



ADA COMPLIANT



FG400586 / FG401591 / FG401532

AutoClean® Dispensers

| NO. | DESCRIPTION | U.S. DIMENSIONS | U.S. SHIP WT/CASE | U.S. CASE CUBE | METRIC DIMENSIONS | METRIC SHIP WT/CASE | METRIC CASE CUBE | CASE PACK |
|----------|---|------------------------------|-------------------|----------------|----------------------------|---------------------|------------------|-----------|
| FG500409 | AutoClean® LED Dispenser — Chrome (Kit w/ 3/4" Connector) | 12.50" l x 1.25" w x 6.75" h | 4.0 lb | 0.23 ft³ | 31.8 cm x 3.2 cm x 17.1 cm | 1.8 kg | 0.01 m³ | 1 |
| FG500410 | AutoClean® LED Dispenser — Chrome (Kit w/ 1/2" Connector) | 12.50" l x 1.25" w x 6.75" h | 4.0 lb | 0.24 ft³ | 31.8 cm x 3.2 cm x 17.1 cm | 1.8 kg | 0.01 m³ | 1 |

*Kits contain: AutoClean® Dispenser, Mounting Hardware, Batteries, Connection Kit, and Stainless Steel Connection Tube.

AutoClean® Refills

| NO. | DESCRIPTION | U.S. DIMENSIONS | U.S. SHIP WT/CASE | U.S. CASE CUBE | METRIC DIMENSIONS | METRIC SHIP WT/CASE | METRIC CASE CUBE | CASE PACK |
|----------|--|--------------------------|-------------------|----------------|---------------------------|---------------------|------------------|-----------|
| FG400586 | Purinel® SC — Drain Maintainer & Cleaner | 1.8" l x 3.9" w x 5.9" h | 1.0 lb | 0.19 ft³ | 4.5 cm x 9.9 cm x 14.9 cm | 0.5 kg | 0.01 m³ | 6 |
| FG401591 | AutoClean® Cleaner & Deodorizer Refill — Linen Fresh™ | 1.8" l x 3.9" w x 5.9" h | 1.0 lb | 0.21 ft³ | 4.5 cm x 9.9 cm x 14.9 cm | 0.5 kg | 0.01 m³ | 6 |
| FG401532 | AutoClean® Cleaner & Deodorizer Refill — Mandarin Orange | 1.8" l x 3.9" w x 5.9" h | 1.0 lb | 0.19 ft³ | 4.5 cm x 9.9 cm x 14.9 cm | 0.5 kg | 0.01 m³ | 6 |

Auto Janitor®

Auto Janitor® cleans and deodorizes toilets and urinals while providing a clean fresh scent for the restroom.

- Programmable dispenser operates round-the-clock automatically cleaning fixture surfaces, day and night, at 15-, 30-, or 60-day refill cycles
- Concentrated foaming action cleans and reduces bacteria growth everywhere the water goes
- Auto Janitor® BioFlush® formula is enzyme-based to help prevent scale buildup in drain pipes



FG400980



Auto Janitor® Dispenser & Accessories

| NO. | DESCRIPTION | U.S. DIMENSIONS | U.S. SHIP WT/CASE | U.S. CASE CUBE | METRIC DIMENSIONS | METRIC SHIP WT/CASE | METRIC CASE CUBE | CASE PACK |
|----------|--------------------------------------|--------------------------|-------------------|----------------|--------------------------|---------------------|------------------|-----------|
| 1793506 | Auto Janitor® LED Dispenser — White | 1.92" l x 1.67" w x 2" h | 2.00 lb | 0.95 ft³ | 4.9 cm x 4.2 cm x 5.1 cm | 0.90 kg | 0.03 m³ | 6 |
| 1793507 | Auto Janitor® LED Dispenser — Chrome | 1.92" l x 1.67" w x 2" h | 2.00 lb | 0.95 ft³ | 4.9 cm x 4.2 cm x 5.1 cm | 0.90 kg | 0.03 m³ | 6 |
| 4012902T | 2nd Fixture Kit | - | 0.42 lb | 0.64 ft³ | - | 0.19 kg | 0.02 m³ | 12 |

Auto Janitor® Refills

| NO. | DESCRIPTION | U.S. SHIP WT/CASE | U.S. CASE CUBE | METRIC SHIP WT/CASE | METRIC CASE CUBE | CASE PACK |
|----------|--|-------------------|----------------|---------------------|------------------|-----------|
| FG400978 | Auto Janitor® Cleaner & Deodorizer Refill — Linen Fresh™ | 11 lbs | 0.42 ft³ | 5.0 kg | 0.01 m³ | 6 |
| FG400980 | Auto Janitor® Cleaner & Deodorizer Refill — Mandarin Orange | 11 lbs | 0.33 ft³ | 5.0 kg | 0.01 m³ | 6 |
| FG400982 | Auto Janitor® Cleaner & Deodorizer Refill — Country Delight™ | 11 lbs | 0.33 ft³ | 5.0 kg | 0.01 m³ | 6 |
| FG400055 | Auto Janitor® BioFlush® Drain Maintenance Refill | 11 lbs | 0.36 ft³ | 5.0 kg | 0.01 m³ | 6 |

Clean Seat

Clean Seat foam and spray toilet seat, baby changing station, and handle cleaners provide an added level of personal hygiene to washroom users.

- Antimicrobial push bar with silver-ion technology reduces cross-contamination
- Foam refill dispenses 1000 shots of 0.4 mL per dose; spray refill dispenses 2000 shots of 0.2 mL per dose
- Alcohol-based solution removes dirt and bacteria and eliminates the need for messy and awkward seat covers



ADA COMPLIANT



Just spray the solution on a toilet tissue, and then wipe the surfaces clean. Handle and seat are hygienic and ready for use in seconds.



FG402310



FG450008

Clean Seat Dispensers

| NO. | DESCRIPTION | U.S. DIMENSIONS | U.S. SHIP WT/CASE | U.S. CASE CUBE | METRIC DIMENSIONS | METRIC SHIP WT/CASE | METRIC CASE CUBE | CASE PACK |
|----------|--|-----------------------------|-------------------|---------------------|---------------------------|---------------------|---------------------|-----------|
| FG402310 | Clean Seat Foam 400 mL Dispenser — White | 5.50" l x 4.75" w x 8.00" h | 12.0 lb | 1.8 ft ³ | 14 cm x 12.1 cm x 20.3 cm | 5.4 kg | 0.05 m ³ | 12 |
| FG450008 | Clean Seat Soap Spray 400 mL Dispenser — White | 4.30" l x 3.70" w x 8.25" h | 11.4 lb | 1.9 ft ³ | 10.9 cm x 9.4 cm x 21 cm | 5.2 kg | 0.05 m ³ | 12 |



FG402312



FG402537

Clean Seat Refills

| NO. | DESCRIPTION | U.S. SIZE | U.S. SHIP WT/CASE | U.S. CASE CUBE | METRIC SHIP WT/CASE | METRIC CASE CUBE | CASE PACK |
|----------|---------------------------|-----------|-------------------|----------------------|---------------------|---------------------|-----------|
| FG402312 | Clean Seat Foaming Refill | 400 mL | 11.9 lb | 0.47 ft ³ | 5.4 kg | 0.01 m ³ | 12 |
| FG402537 | Clean Seat Spray Refill | 400 mL | 1.0 lb | 0.41 ft ³ | 0.5 kg | 0.01 m ³ | 12 |

UTILITY REFUSE AND RECYCLING

DECORATIVE REFUSE

CLEANING

MATERIAL HANDLING

WASHROOM

FOODSERVICE

ACCESSORIES & INDEX



Baby Changing Stations

Horizontal and vertical baby changing stations meet all applicable ASTM, ADA, FDA, and EN global safety regulations and standards.

- Antimicrobial protection
- Easy-reach hooks
- Built-in shelf and liner storage



FG781888



FG781988

| NO. | COLOR | DESCRIPTION | U.S. DIMENSIONS | U.S. SHIP WT/CTN | METRIC DIMENSIONS | METRIC SHIP WT/CTN | PACK |
|----------|--------------|---|-------------------------------|------------------|-----------------------------|--------------------|-----------|
| FG781788 | WHT | Protective Liners for Baby Changing Stations Laminated 2-ply Tissue Paper | 13.25" l x 5.50" w x 0.00" h | 4.8 lb | 33.7 cm x 14 cm x 0 cm | 2.2 kg | 1/320 Ctn |
| FG781888 | LPLAT | Baby Changing Station Horizontal | 33.25" l x 21.50" w x 4.00" h | 23.5 lb | 84.5 cm x 54.6 cm x 10.2 cm | 10.7 kg | 1 |
| FG781988 | LPLAT | Baby Changing Station Vertical | 23.00" l x 34.10" w x 4.00" h | 25.0 lb | 58.4 cm x 86.6 cm x 10.2 cm | 11.3 kg | 1 |

When ordering products with **BOLD** color codes, please specify color code after the product number. Refer to the Standard Color Guide at the back of the catalog.

UTILITY REFUSE AND RECYCLING

DECORATIVE REFUSE

CLEANING

MATERIAL HANDLING

WASHROOM

FOODSERVICE

ACCESSORIES & INDEX

Sanitary Bins

Designed to provide a safe and hygienic way to dispose of sanitary waste.

- Deep chute prevents waste adhesion and promotes better hygiene
- Dry system bins are lined so the interior is never soiled
- Pedal operation limits direct contact
- Smooth contoured shape does not harbor dirt or germs and is easy to clean



FG402348



SaniSense Bin Deodorizer™ activates when waste is placed in the bin.

| NO. | DESCRIPTION | U.S. DIMENSIONS | U.S. SHIP WT/CASE | U.S. CASE CUBE | METRIC DIMENSIONS | METRIC SHIP WT/CASE | METRIC CASE CUBE | CASE PACK |
|----------|--|----------------------------|-------------------|----------------|---------------------------|---------------------|------------------|-----------|
| FG402338 | Sanitary Bin 5 Gallon — White | 22.8" l x 6.1" w x 19.3" h | 26.4 lb | 7.6 ft³ | 57.9 cm x 15.5 cm x 49 cm | 12.0 kg | 0.22 m³ | 4 |
| FG750243 | Sanitary Bin 3 Gallon — White | 16.5" l x 6.1" w x 19.3" h | 5.1 lb | 1.3 ft³ | 41.9 cm x 15.5 cm x 49 cm | 2.3 kg | 0.04 m³ | 1 |
| FG750244 | Sanitary Bin 3 Gallon — Gray | 16.5" l x 6.1" w x 19.3" h | 5.1 lb | 1.3 ft³ | 41.9 cm x 15.5 cm x 49 cm | 2.3 kg | 0.04 m³ | 1 |
| FG402348 | SaniSense Bin Deodorizer™ | N/A | 29.0 lb | 0.9 ft³ | N/A | 13.2 kg | 0.03 m³ | 12 |
| FG402339 | Sanitary Bin 5 Gallon Liners — 15 per roll | N/A | 6.8 lb | 0.3 ft³ | N/A | 3.1 kg | 0.01 m³ | 1 |
| FG750443 | Sanitary Bin 3 Gallon Liners — 15 per roll | N/A | 6.8 lb | 0.3 ft³ | N/A | 3.1 kg | 0.01 m³ | 25 |

Sanitary Napkin Receptacles

Space-saving and easy to service.

- Tight-fitting lids help contain odors
- Removable rigid liner is easy to clean and maintain
- Durable plastic and metal receptacles



FG614000



FG614100

| NO. | COLOR | DESCRIPTION | U.S. DIMENSIONS | U.S. SHIP WT/CTN | METRIC DIMENSIONS | METRIC SHIP WT/CTN | MATERIAL TYPE | PACK |
|----------|-------|---|------------------------------|------------------|-----------------------------|--------------------|---------------|-------|
| FG614000 | WHT | Sanitary Napkin Receptacle with Rigid Liner | 10.75" l x 5.25" w x 12.5" h | 2.6 lb | 27.3 cm x 13.3 cm x 31.8 cm | 1.2 kg | Plastic | 1 |
| FG614100 | 0000 | Waxed Bags for Sanitary Napkin Receptacle | 8.75" l x 8.50" h | 6.2 lb | 22.2 cm x 21.6 cm | 2.8 kg | | 1/250 |

Safty-Grip® Bath and Shower Mats

Perfect for shower stall or bathtub.

- Suction-backed to stay firmly in place
- Latex-free construction
- Textured surface prevents slippage
- Shower mat is perforated for improved drainage
- Mildew-resistant



1982725



1982724

| NO. | COLOR | DESCRIPTION | U.S. DIMENSIONS | U.S. SHIP WT/CTN | METRIC DIMENSIONS | METRIC SHIP WT/CTN | PACK |
|---------|-------------|------------------------------|---------------------|------------------|-------------------|--------------------|------|
| 1982721 | Brown Stone | Safty-Grip® Bath Mat, Medium | 22.50" l x 14.00" w | 4.9 lb | 57.2 cm x 35.6 cm | 2.2 kg | 12 |
| 1982724 | White | Safty-Grip® Bath Mat, Medium | 22.50" l x 14.00" w | 4.9 lb | 57.2 cm x 35.6 cm | 2.2 kg | 12 |
| 1982725 | Brown Stone | Safty-Grip® Bath Mat, Large | 28.00" l x 16.00" w | 8.9 lb | 71.1 cm x 40.6 cm | 4.0 kg | 12 |
| 1982726 | White | Safty-Grip® Bath Mat, Large | 28.00" l x 16.00" w | 8.9 lb | 71.1 cm x 40.6 cm | 4.0 kg | 12 |
| 1982728 | Brown Stone | Safty-Grip® Bath Mat, XLarge | 36.00" l x 18.00" w | 12.4 lb | 91.4 cm x 45.7 cm | 5.6 kg | 12 |
| 1982729 | White | Safty-Grip® Bath Mat, XLarge | 36.00" l x 18.00" w | 12.4 lb | 91.4 cm x 45.7 cm | 5.6 kg | 12 |
| 1982727 | White | Safty-Grip® Shower Mat | 22.25" l x 22.25" w | 1.3 lb | 56.5 cm x 56.5 cm | 0.6 kg | 12 |

UTILITY REFUSE AND RECYCLING

DECORATIVE REFUSE

CLEANING

MATERIAL HANDLING

WASHROOM

FOODSERVICE

ACCESSORIES & INDEX

UTILITY REFUSE
AND RECYCLING



FOODSERVICE

DECORATIVE REFUSE

CLEANING

MATERIAL HANDLING

WASHROOM

FOODSERVICE

ACCESSORIES
& INDEX



PROSERVE® INGREDIENT BINS



1980418

STORAGE

ProSave® Ingredient Management System – Bins 222
 Racks for Shelf Ingredient Bins..... 223
 ProSave® Ingredient Management System – BRUTE® and Sliding Lids 224
 Food Boxes 226
 Freshworks™ Produce Saver..... 227
 Space-Saving Square Containers..... 228
 Square Container Lids..... 228
 Round Storage Containers 229
 Round Container Lids 229
 Heavy-Duty Hot and Cold Food Pans 230

PREPARATION

High-Heat Scrapers and Spoons..... 232
 Cold Scrapers and Spoons 232
 Measuring Cups and Spoons 232
 Bouncer® Measuring Cups 233
 Bouncer® Scoops and Bouncer® Portioning Scoops..... 233
 BRUTE® GreensKeeper® Containers 233

MONITORING

Premium Digital Portion Control Scales 234
 Digital Portion Control Scales..... 234
 Premium Mechanical Portion Control Scales..... 235
 Stainless Steel Scales, Dishwasher-Safe..... 235
 Mechanical Portion Control Scales 235
 Digital Receiving Utility Scales 236
 Briefcase/Utility Mechanical Receiving Scales 236
 Fixed Dial Platform Receiving Scales 236

TRANSPORT

ProServe® Ice Handling System..... 237
 BRUTE® "ICE ONLY" Container 237
 ProServe® Lightweight Insulated Carriers..... 238
 ProServe® Professional Delivery Bags..... 239
 ProServe® Sheet Pan Rack System..... 239
 ProServe® Racks and Carts..... 240

TABLE SERVICE

Bus/Tote Boxes..... 241
 Cutlery Bin..... 241
 Bouncer® Pitchers 241

YOUTH SERVICE

Sturdy Chair™ Youth Seats 242

FOODSERVICE

KEEP PRODUCE FRESHER LONGER*

The FreshWorks™ Produce Saver regulates the flow of oxygen and ethylene, creating the optimal environment to store fruits and vegetables. By allowing the produce to “breathe”, the FreshWorks™ Produce Saver helps maintain stay at their peak freshness for a longer period of time, reducing the amount of food thrown away due to spoilage.

*Based on produce stored in RCP FreshWorks™ Produce Saver vs traditional food box.



FILTER

The integrated filter naturally regulates the flow of oxygen to allow produce to remain fresh for an extended period of time.



DRAIN TRAY

The built in drain tray promotes air flow while elevating produce from any residual moisture, preventing a soggy product.



AIR TIGHT LID

The air tight lid is easy to open and close helping to create the perfect environment within the container.

ProSave® Ingredient Management System
INGREDIENT BINS

Improved productivity through integrated lid and scoop system.

- Integrated lid and measuring scoop allows for quick one-handed access to stored ingredients
- Clear window for fast ingredient identification and inventory management
- Certified to NSF/ANSI/3-A and 2 Standards
- Commercial dishwasher-safe
- Complies with FDA Food code 3-304.12 to increase inspection score
- One-handed access while stacked improves space efficiency
- FIFO (First In First Out) barrier for proper food rotation improves food quality



65%

PRODUCTIVITY SAVINGS

with one-handed access



FG360088
400 Cups
124 lb flour



FG360288
500 Cups
154 lb flour



FG360388
600 Cups
188 lb flour



FG9G6000
40 Cups
13 lb flour



FG9G5700
100 Cups
25 lb flour



FG9G5800
200 Cups
50 lb flour



Dedicated internal scoop, included with bin, has proper storage to meet safety compliance.



Speed up food preparation with one-handed access.



Ensure proper food rotation with FIFO barrier.

ProSave® Ingredient Bins

| NO. | COLOR | DESCRIPTION | U.S. CAPACITY (GAL/CU. FT) | U.S. FLOUR/SUGAR CAPACITY | DIMENSIONS | U.S. SHIP WT/CTN | METRIC CAPACITY | METRIC FLOUR/SUGAR CAPACITY | METRIC DIMENSIONS | METRIC SHIP WT/CTN | PACK |
|----------|------------|---|----------------------------|--------------------------------|------------------------------|------------------|--------------------|------------------------------------|-----------------------------|--------------------|------|
| FG9G6000 | WHT | 40-Cup Shelf Ingredient Bin with 1/2-Cup Scoop | 2.63 gal .33 cu ft | Flour: 13 lb Sugar: 17 lb | 15" l x 11.75" w x 8.5" h | 3.30 lb | .12 m ³ | Flour: 5.90 kg Sugar: 7.71 kg | 38.1 cm x 29.8 cm x 21.6 cm | 1.5 kg | 1 |
| FG9G5700 | WHT | 100-Cup Shelf Ingredient Bin with 2-Cup Scoop | 6.25 gal .836 cu ft | Flour: 25 lb Sugar: 50 lb | 23.5" l x 11.5" w x 16.88" h | 13.25 lb | .08 m ³ | Flour: 11.34 kg Sugar: 22.68 kg | 59.7 cm x 29.2 cm x 42.9 cm | 6.01 kg | 1 |
| FG9G5800 | WHT | 200-Cup Shelf Ingredient Bin with 2-Cup Scoop | 12.63 gal 1.67 cu ft | Flour: 50 lb Sugar: 100 lb | 23.5" l x 19.2" w x 16.88" h | 18.5 lb | .10 m ³ | Flour: 22.68 kg Sugar: 45.36 kg | 59.7 cm x 48.8 cm x 42.9 cm | 8.39 kg | 1 |
| FG360088 | WHT | Slant-Front Ingredient Bin with Sliding Lid and 32-oz (0.9-L) Scoop | 20.5 gal 2.75 cu ft | Flour: 124 lb Sugar: 158 lb | 29.25" l x 13.13" w x 28" h | 27.7 lb | .08 m ³ | Flour: 56.3 kg Sugar: 72.7 kg | 74.3 cm x 33.4 cm x 71.1 cm | 12.6 kg | 1 |
| FG360288 | WHT | Slant-Front Ingredient Bin with Sliding Lid and 32-oz (0.9-L) Scoop | 26.2 gal 3.5 cu ft | Flour: 154 lb Sugar: 197 lb | 29.5" l x 15.5" w x 28" h | 32.7 lb | .1 m ³ | Flour: 69.9 kg Sugar: 89.4 kg | 74.9 cm x 39.4 cm x 71.1 cm | 14.8 kg | 1 |
| FG360388 | WHT | Slant-Front Ingredient Bin with Sliding Lid and 32-oz (0.9-L) Scoop | 30.8 gal 4.12 cu ft | Flour: 188 lb Sugar: 240 lb | 29.75" l x 18" w x 28" h | 38.7 lb | .12 m ³ | Flour: 85.3 kg Sugar: 108.9 kg | 75.6 cm x 45.7 cm x 71.1 cm | 17.6 kg | 1 |

ProSave® Lids With Scoops

| NO. | COLOR | DESCRIPTION | U.S. DIMENSIONS | FITS RUBBERMAID® INGREDIENT BIN | U.S. SHIP WT/CTN | METRIC DIMENSIONS | METRIC SHIP WT/CTN | PACK |
|----------|------------|--|--------------------------|---------------------------------|------------------|----------------------------|--------------------|------|
| FG9F7700 | CLR | Sliding Lid with 32-oz (0.9-L) Scoop for FG360088 Ingredient Bin | 29" l x 12.1" w x 1.9" h | FG360088 | 5.8 lb | 73.7 cm x 30.7 cm x 4.8 cm | 2.6 kg | 1 |
| FG9F7800 | CLR | Sliding Lid with 32-oz (0.9-L) Scoop for FG360288 Ingredient Bin | 29" l x 14.5" w x 1.9" h | FG360288 | 6.5 lb | 73.7 cm x 36.8 cm x 4.8 cm | 2.9 kg | 1 |
| FG9F7900 | CLR | Sliding Lid with 32-oz (0.9-L) Scoop for FG360388 Ingredient Bin | 29" l x 17.2" w x 1.9" h | FG360388 | 7.4 lb | 73.7 cm x 43.7 cm x 4.8 cm | 3.4 kg | 1 |

UTILITY REFUSE AND RECYCLING

DECORATIVE REFUSE

CLEANING & SAFETY

MATERIAL HANDLING

WASHROOM

FOODSERVICE

ACCESSORIES & INDEX

Racks for Shelf Ingredient Bins

Store and transport bins efficiently throughout the operation.

- Maximize space for kitchen preparation and storeroom for ingredient storage
- Racks designed to hold and transport 200 lbs. (90.7 kg) per shelf
- 5" nonmarking casters for safe transport
- Locating bar on shelf to secure bins during transport
- Customize your shelf ingredient bins in storage with different configurations



FG9G5900
Rack
26" Wide



FG9G7900
Rack
38" Wide



FG9G8000
Rack
50" Wide

Racks For ProSave® Shelf Ingredient Bins

| NO. | COLOR | DESCRIPTION | | U.S. DEPTH | U.S. WIDTH | U.S. HEIGHT | CASE WEIGHT (LBS) | METRIC DEPTH | METRIC WIDTH | METRIC HEIGHT | CASE WEIGHT (KG) | CASE PACK |
|----------|-------|---|---|------------|------------|-------------|-------------------|--------------|--------------|---------------|------------------|-----------|
| FG9G5900 | CHRM | Cart for Shelf Ingredient Bins | 2 Shelves, Each Shelf Holds (4) FG9G6000, (2) FG9G5700, or (1) FG9G5800 | 18" | 26" | 47.75" | 37.5 lb | 45.7 cm | 66 cm | 121.3 cm | 17 kg | 1 |
| FG9G7900 | CHRM | Mobile Rack for Shelf Ingredient Bins, 38" wide | 3 Shelves, Each Shelf Holds (6) FG9G6000, (3) FG9G5700, or (1) FG9G5800 | 18" | 38" | 48.276" | 43.8 lb | 35.6 cm | 96.5 cm | 122.6 cm | 19.9 kg | 1 |
| FG9G8000 | CHRM | Mobile Rack for Shelf Ingredient Bins, 50" wide | 4 Shelves, Each Shelf Holds (8) FG9G6000, (4) FG9G5700, or (2) FG9G5800 | 18" | 50" | 67.157" | 76.0 lb | 45.7 cm | 127 cm | 170.5 cm | 34.5 kg | 1 |

Scoops

| NO. | COLOR | DESCRIPTION | CUPS (LITERS) | U.S. DEPTH | U.S. WIDTH | U.S. HEIGHT | CASE WEIGHT (LBS) | METRIC DEPTH | METRIC WIDTH | METRIC HEIGHT | CASE WEIGHT (KG) | CASE PACK |
|-----------|-------|---|------------------|------------|------------|-------------|-------------------|--------------|--------------|---------------|------------------|-----------|
| FG9G8200* | WHT | 1/2-Cup Measuring Scoop for FG9G6000 Shelf Ingredient Bin | 1/2 Cup (0.12 L) | 7.38" | 3.38" | 1.50" | 1.05 lb | 18.7 cm | 8.6 cm | 3.8 cm | .48 kg | 12 |
| FG9F7500* | CLR | Bouncer® Contour Scoop for FG360088, FG360288, FG360388 Ingredient Bins and FG9G7700 | 32 oz (0.95 L) | 10.8" | 4.8" | 4.7" | 4.2 lb | 27.4 cm | 12.2 cm | 12 cm | 1.9 kg | 6 |
| FG9F7600* | CLR | Bouncer® Contour Scoop for FG360088, FG360288, FG360388 Ingredient Bins and FG9G7800 | 64 oz (1.90 L) | 13.44" | 5.89" | 6.0" | 6.2 lb | 34.1 cm | 15 cm | 15.2 cm | 2.8 kg | 6 |
| FG9G5100* | CLR | Bouncer® Portioning Scoop for FG9G5700, FG9G5800 Shelf Ingredient Bins and FG9G7600, FG9G7300 | 2 Cups (0.47 L) | 4.6" | 5.1" | 5.25" | 3.2 lb | 11.7 cm | 13 cm | 13.3 cm | 1.4 kg | 12 |
| FG9G5200* | CLR | Bouncer® Portioning Scoop for FG9G7700, FG9G7400 Sliding Lid | 3 Cups (0.71 L) | 6" | 5.1" | 5.70" | 4.0 lb | 15.2 cm | 13 cm | 14.5 cm | 1.8 kg | 12 |
| FG9G5300* | CLR | Bouncer® Portioning Scoop for FG9G7800, FG9G7500 Sliding Lid | 4 Cups (0.95 L) | 6" | 5.60" | 6.60" | 5.0 lb | 15.2 cm | 14.2 cm | 16.8 cm | 2.3 kg | 12 |

*Certified to NSF Std. 2.

UTILITY REFUSE AND RECYCLING

DECORATIVE REFUSE

CLEANING & SAFETY

MATERIAL HANDLING

WASHROOM

FOODSERVICE

ACCESSORIES & INDEX



**ProSave® Ingredient Management System
BRUTE® INGREDIENT CONTAINERS AND SLIDING LIDS**

Designed for quick one-handed access to ingredients in a high-production facility.

- Rotating lid allows for one-handed access
- Dedicated internal scoop storage complies with food code for safe access
- Hook options for 32- and 64-oz. Contour Scoop allows for ingredient access flexibility
- Clear windows for fast ingredient identification and inventory management
- Certified to NSF/ANSI/3-A and 2 Standards
- Commercial dishwasher-safe



Improve safety compliance with dedicated internal scoop storage.



Enhance food production efficiency with rotating clear lid.



FG264000
Dolly



FG9G7600 /
FG9G7700 /
FG9G7800
Sliding Lid



FG9G7300
150 Cups
47 lb flour



FG9G7400
300 Cups
94 lb flour



FG9G7500
500 Cups
156 lb flour

ProSave® Ingredient Container Lids

| NO. | COLOR | DESCRIPTION | DEPTH | WIDTH | HEIGHT | CASE WEIGHT (LB TO KG) | CASE PACK |
|----------|-------|---|--------|--------|--------|------------------------|-----------|
| FG9G7600 | WHT | Sliding Lid with 2-Cup Scoop (fits FG261088 BRUTE® Container) | 17" | 17" | 4.75" | 3.04 lb (1.38 kg) | 1 |
| FG9G7700 | WHT | Sliding Lid with 3-Cup Scoop (fits FG262088 BRUTE® Container) | 20.75" | 20.75" | 5" | 4.30 lb (1.95 kg) | 1 |
| FG9G7800 | WHT | Sliding Lid with 4-Cup Scoop (fits FG263288 BRUTE® Container) | 23.50" | 23.50" | 5.25" | 5.25 lb (2.38 kg) | 1 |

ProSave® Ingredient Container Combos

| NO. | COLOR | DESCRIPTION | GALLONS (LITERS) | CUPS (LITERS) | CUBIC FT ³ (METERS M ³) | FLOUR LB (KG) | SUGAR LB (KG) | DEPTH | WIDTH | HEIGHT | CASE WEIGHT (LB/KG) | CASE PACK |
|----------|-------|--|------------------|---------------|--|---------------|---------------|--------|--------|--------|---------------------|-----------|
| FG9G7300 | WHT | Sliding Lid w/ 2-Cup Scoop and FG261088 BRUTE® Container COMBO | 10 (37.85) | 150 (35.49) | 1.33 (0.04) | 47 (21) | 65 (29) | 15.63" | 15.63" | 17.13" | 19.0 lb (8.62 kg) | 6 |
| FG9G7400 | WHT | Sliding Lid w/ 3-Cup Scoop and FG262088 BRUTE® Container COMBO | 20 (75.70) | 300 (70.98) | 2.66 (0.08) | 94 (43) | 130 (59) | 19.50" | 19.50" | 22.88" | 35.0 lb (15.88 kg) | 6 |
| FG9G7500 | WHT | Sliding Lid w/ 4-Cup Scoop and FG263288 BRUTE® Container COMBO | 32 (121.12) | 500 (118.29) | 4.28 (0.12) | 156 (71) | 217 (98) | 22" | 22" | 27.25" | 49.5 lb (22.45 kg) | 6 |

ProSave® Ingredient Containers

| NO. | COLOR | DESCRIPTION | GALLONS (LITERS) | CUPS (LITERS) | CUBIC FT ³ (METERS M ³) | FLOUR LB (KG) | SUGAR LB (KG) | DEPTH | WIDTH | HEIGHT | CASE WEIGHT (LB TO KG) | CASE PACK |
|----------|-------|---|------------------|---------------|--|---------------|---------------|--------|--------|--------|------------------------|-----------|
| FG261088 | WHT | BRUTE® Container without Lid | 10 (37.85) | 150 (35.49) | 1.33 (0.04) | 47 (21) | 65 (29) | 15.63" | 15.63" | 17.13" | 19.0 lb (8.62 kg) | 6 |
| FG262088 | WHT | BRUTE® Container without Lid | 20 (75.70) | 300 (70.98) | 2.66 (0.08) | 94 (43) | 130 (59) | 19.50" | 19.50" | 22.88" | 35.0 lb (15.88 kg) | 6 |
| FG263288 | WHT | BRUTE® Container without Lid | 32 (121.12) | 500 (118.29) | 4.28 (0.12) | 156 (71) | 217 (98) | 22" | 22" | 27.25" | 49.5 lb (22.45 kg) | 6 |
| FG264000 | BLA | BRUTE® Dolly for FG9G7400, FG9G7500, FG262088, and FG263288 | | | | | | 18.25" | 18.25" | 6.63" | 13.1 lb (5.94 kg) | 2 |

When ordering products with **BOLD** color codes, please specify color code after the product number. Refer to the Standard Color Guide at the back of the catalog.

UTILITY REFUSE AND RECYCLING

DECORATIVE REFUSE

CLEANING & SAFETY

MATERIAL HANDLING

WASHROOM

FOODSERVICE

ACCESSORIES & INDEX



UTILITY REFUSE
AND RECYCLING

DECORATIVE REFUSE

CLEANING
& SAFETY

MATERIAL HANDLING

WASHROOM

FOODSERVICE

ACCESSORIES
& INDEX

Food Boxes

Durable storage solution for food as it flows throughout your facility.

- Crystal-clear material is stain- and odor-resistant and allows for visibility of food contents and quality
- White polyethylene containers provide durable and practical solution
- Texturing on corners and base reduces scratching
- Labeling window visible on bases and lids for date and information coding
- Available in standard sizes of 18" x 12" and 26" x 18"

SOLID FLAT LIDS

- Durable lids snap tightly into place during transport and keep foods fresh
- Use lid as a tray when displayed upside down
- Available in crystal-clear material or white polyethylene



FG330000 and F330200



Crystal-Clear Food Boxes and Lids

| NO. | COLOR | DESCRIPTION | U.S. CAPACITY | U.S. DIMENSIONS | U.S. SHIP WT/CTN | METRIC CAPACITY | METRIC DIMENSIONS | METRIC SHIP WT/CTN | CASE PACK |
|----------|-------|--|---------------|------------------------|------------------|-----------------|-------------------------------|--------------------|-----------|
| FG330600 | CLR | Food/Tote Box | 5 gal | 26" l x 18" w x 3.5" d | 21.5 lb | 18.9 L | 66 cm x 45.7 cm x 8.9 cm | 9.8 kg | 6 |
| FG330800 | CLR | Food/Tote Box | 8½ gal | 26" l x 18" w x 6" d | 30.0 lb | 32.2 L | 66 cm x 45.7 cm x 15.2 cm | 13.6 kg | 6 |
| FG330000 | CLR | Food/Tote Box | 12½ gal | 26" l x 18" w x 9" d | 42.9 lb | 47.3 L | 66 cm x 45.7 cm x 22.9 cm | 19.5 kg | 6 |
| FG332800 | CLR | Food/Tote Box | 16⅔ gal | 26" l x 18" w x 12" d | 54.9 lb | 62.9 L | 66 cm x 45.7 cm x 30.5 cm | 24.9 kg | 6 |
| FG330100 | CLR | Food/Tote Box | 21½ gal | 26" l x 18" w x 15" d | 66.9 lb | 81.4 L | 66 cm x 45.7 cm x 38.1 cm | 30.3 kg | 6 |
| FG330200 | CLR | Lid for FG330000, FG330100, FG330600, FG330800, FG332800 Food/Tote Boxes | N/A | 26" l x 18" w | 16.9 lb | N/A | 66 cm x 45.7 cm | 7.7 kg | 6 |
| FG330700 | CLR | Food/Tote Box | 2 gal | 18" l x 12" w x 3.5" d | 10.4 lb | 7.6 L | 45.7 cm x 30.5 cm x 8.9 cm | 4.7 kg | 6 |
| FG330900 | CLR | Food/Tote Box | 3½ gal | 18" l x 12" w x 6" d | 18.0 lb | 13.2 L | 45.7 cm x 30.5 cm x 15.2 cm | 8.2 kg | 6 |
| FG330400 | CLR | Food/Tote Box | 5 gal | 18" l x 12" w x 9" d | 22.1 lb | 18.9 L | 45.7 cm x 30.5 cm x 22.9 cm | 10 kg | 6 |
| FG331000 | CLR | Lid for FG330400, FG330700, FG330900 Food/Tote Boxes | N/A | 18" l x 12" w | 7.6 lb | N/A | 45.7 cm x 30.5 cm | 3.4 kg | 6 |
| FG331400 | CLR | Drain Tray | N/A | 18" l x 12" w | 3.5 lb | N/A | 45.7 cm l x 30.5 cm w | 1.59 kg | 6 |
| FG331800 | CLR | Drain Tray | N/A | 26" l x 18" w | 2.9 lb | N/A | 66 cm l x 45.7 cm w | 1.32 kg | 6 |
| FG330300 | CLR | Colander for Tote Boxes 6" deep or greater | N/A | 26" l x 18" w x 5" d | 26.7 lb | N/A | 66 cm l x 45.7 cm w x 12.7 cm | 12.21 kg | 6 |

Polyethylene Food Boxes and Lids

| NO. | COLOR | DESCRIPTION | U.S. CAPACITY | U.S. DIMENSIONS | U.S. SHIP WT/CTN | METRIC CAPACITY | METRIC DIMENSIONS | METRIC SHIP WT/CTN | CASE PACK |
|----------|-------|--|---------------|------------------------|------------------|-----------------|-----------------------------|--------------------|-----------|
| FG350600 | WHT | Food/Tote Box | 5 gal | 26" l x 18" w x 3.5" d | 18.1 lb | 18.9 L | 66 cm x 45.7 cm x 8.9 cm | 8.2 kg | 6 |
| FG350800 | WHT | Food/Tote Box | 8½ gal | 26" l x 18" w x 6" d | 23.3 lb | 32.2 L | 66 cm x 45.7 cm x 15.2 cm | 10.5 kg | 6 |
| FG350000 | WHT | Food/Tote Box | 12½ gal | 26" l x 18" w x 9" d | 31.7 lb | 47.3 L | 66 cm x 45.7 cm x 22.9 cm | 14.4 kg | 6 |
| FG352800 | WHT | Food/Tote Box | 16⅔ gal | 26" l x 18" w x 12" d | 41.8 lb | 62.9 L | 66 cm x 45.7 cm x 30.5 cm | 19 kg | 6 |
| FG350100 | WHT | Food/Tote Box | 21½ gal | 26" l x 18" w x 15" d | 52.9 lb | 81.4 L | 66 cm x 45.7 cm x 38.1 cm | 24 kg | 6 |
| FG350200 | WHT | Lid for FG350000, FG350100, FG350600, FG350800, FG352800 Food/Tote Boxes | N/A | 26" l x 18" w | 14.8 lb | N/A | 66 cm x 45.7 cm | 6.7 kg | 6 |
| FG350700 | WHT | Food/Tote Box | 2 gal | 18" l x 12" w x 3.5" d | 8.2 lb | 7.6 L | 45.7 cm x 30.5 cm x 8.9 cm | 3.7 kg | 6 |
| FG350900 | WHT | Food/Tote Box | 3½ gal | 18" l x 12" w x 6" d | 14.0 lb | 13.2 L | 45.7 cm x 30.5 cm x 15.2 cm | 6.4 kg | 6 |
| FG350400 | WHT | Food/Tote Box | 5 gal | 18" l x 12" w x 9" d | 17.2 lb | 18.9 L | 45.7 cm x 30.5 cm x 22.9 cm | 7.8 kg | 6 |
| FG351000 | WHT | Lid for FG350400, FG350700, FG350900 Food/Tote Boxes | N/A | 18" l x 12" w | 7.1 lb | N/A | 45.7 cm x 30.5 cm | 3.2 kg | 6 |

FreshWorks™ Produce Saver

The RCP FreshWorks™ Produce Saver Keeps Produce Fresher Longer.*

- Patented Filter regulates the flow of oxygen and ethylene, keeping lettuce fresh up to 2X longer**
- Filter never needs to be changed or replaced
- Built in drain tray elevates produce from any residual moisture to promote air flow
- Air tight lid helps create the perfect environment within the container
- Heavy Duty Polycarbonate lid and base
- Dishwasher-safe

*Based on produce stored in RCP FreshWorks™ vs traditional food box

**Based on romaine lettuce stored in RCP FreshWorks™ vs. traditional food box



| NO. | COLOR | DESCRIPTION | U.S. CAPACITY | U.S. DIMENSIONS | U.S. SHIP WT/CTN | METRIC CAPACITY | METRIC DIMENSIONS | METRIC SHIP WT/CTN | CASE PACK |
|---------|-------|--------------------------|---------------|----------------------------|------------------|-----------------|--------------------------------|--------------------|-----------|
| 2052879 | CLR | FreshWorks™ Produce Set | 3 g | 18.0" l x 12.0" w x 6.8" h | 16.01 lb | 11.36 L | 45.72 cm x 30.48 cm x 17.23 cm | 7.26 kg | 4 |
| 2052933 | CLR | FreshWorks™ Produce Set | 5 g | 18.0" l x 12.0" w x 9.8" h | 19.88 lb | 18.93 L | 45.72 cm x 30.48 cm x 24.89 cm | 9.02 kg | 4 |
| 2052931 | CLR | FreshWorks™ Produce Set | 8 g | 26.0" l x 18.0" w x 6.8" h | 31.20 lb | 30.28 L | 66.04 cm x 45.72 cm x 17.23 cm | 14.15 kg | 4 |
| 2052878 | CLR | FreshWorks™ Produce Set | 12 g | 26.0" l x 18.0" w x 9.8" h | 37.97 lb | 45.42 L | 66.04 cm x 45.72 cm x 24.89 cm | 17.22 kg | 4 |
| 2052936 | WHT | FreshWorks™ Produce Lid | 3/5 g | 18.0" l x 12.0" w x 1.2" h | 5.32 lb | N/A | 45.72 cm x 30.48 cm x 3.17 cm | 2.41 kg | 4 |
| 2052934 | WHT | FreshWorks™ Produce Lid | 8/12 g | 26.0" l x 18.0" w x 1.3" h | 11.26 lb | N/A | 66.04 cm x 45.72 cm x 3.19 cm | 5.11 kg | 4 |
| 2052935 | CLR | FreshWorks™ Produce Base | 3 g | 18.0" l x 12.0" w x 6.3" h | 10.69 lb | 11.36 L | 45.72 cm x 30.28 cm x 16.08 cm | 4.85 kg | 4 |
| 2052932 | CLR | FreshWorks™ Produce Base | 5 g | 18.0" l x 12.0" w x 9.3" h | 14.56 lb | 18.93 L | 45.71 cm x 30.48 cm x 23.74 cm | 6.60 kg | 4 |
| 2052983 | CLR | FreshWorks™ Produce Base | 8 g | 26.0" l x 18.0" w x 6.3" h | 19.94 lb | 30.28 L | 66.03 cm x 45.71 cm x 16.08 cm | 9.05 kg | 4 |
| 2052880 | CLR | FreshWorks™ Produce Base | 12 g | 26.0" l x 18.0" w x 9.3" h | 26.71 lb | 45.42 L | 66.03 cm x 45.71 cm x 23.74 cm | 12.12 kg | 4 |



Space-Saving Square Containers

Stackable containers store more in less space.

- Square containers store a minimum of 25% more on a shelf than round containers
- Available in break-resistant, crystal-clear material for visibility
- Manage food inventory with easy-to-read measurement graduations—red for quarts and blue for liters
- Durable handles for easy transport and drain holes for proper washing and drying
- Temperature range for clear containers: -40°F to 212°F (-40°C to 100°C)
- Temperature range for white containers: -20°F to 150°F (-29°C to 66°C)
- Assists in complying with HACCP guidelines
- NSF 3-A Meat and Poultry Equipment and NSF 2-certified
- Commercial dishwasher-safe



Polycarbonate Square Storage Containers



FG650900 / FG630200 FG650900 / FG630400 FG650900 / FG630600 FG650900 / FG630800 FG652300 / FG631200 FG652300 / FG631800 FG652300 / FG632200

Crystal-Clear Square Storage Containers

| NO. | COLOR | DESCRIPTION | U.S. CAPACITY | U.S. DIMENSIONS | U.S. SHIP WT/CTN | METRIC CAPACITY | METRIC DIMENSIONS | METRIC SHIP WT/CTN | CASE PACK |
|----------|-------|-------------------------------|---------------|-------------------------------|------------------|-----------------|-----------------------------|--------------------|-----------|
| FG630200 | CLR | Space-Saving Square Container | 2 qt | 8.75" l x 8.8" w x 2.69" h | 7.03 lb | 1.9 L | 22.2 cm x 22.4 cm x 6.8 cm | 3.2 kg | 12 |
| FG630400 | CLR | Space-Saving Square Container | 4 qt | 8.75" l x 8.8" w x 4.75" h | 10.44 lb | 3.8 L | 22.2 cm x 22.4 cm x 12.1 cm | 4.7 kg | 12 |
| FG630600 | CLR | Space-Saving Square Container | 6 qt | 8.75" l x 8.8" w x 6.94" h | 14.06 lb | 5.7 L | 22.2 cm x 22.4 cm x 17.6 cm | 6.4 kg | 12 |
| FG630800 | CLR | Space-Saving Square Container | 8 qt | 8.75" l x 8.8" w x 8.75" h | 9.415 lb | 7.6 L | 22.2 cm x 22.4 cm x 22.2 cm | 4.3 kg | 6 |
| FG631200 | CLR | Space-Saving Square Container | 12 qt | 11.31" l x 10.5" w x 7.75" h | 10.97 lb | 11.4 L | 28.7 cm x 26.7 cm x 19.7 cm | 5 kg | 6 |
| FG631800 | CLR | Space-Saving Square Container | 18 qt | 11.31" l x 10.5" w x 11.94" h | 17.22 lb | 17 L | 28.7 cm x 26.7 cm x 30.3 cm | 7.8 kg | 6 |
| FG632200 | CLR | Space-Saving Square Container | 22 qt | 11.31" l x 10.5" w x 14.44" h | 22.96 lb | 20.8 L | 28.7 cm x 26.7 cm x 36.7 cm | 10.4 kg | 6 |

Square Container Lids

Use color-coded storage containers and lids to keep uncooked foods like raw meat separate from ready-to-eat foods.

- Leak-resistant, snap-tight lids
- Corner pull tabs for easy lid removal



COLORS AVAILABLE:



FG650900WHT 1980200 1980301
1980302 1980303 1980304

Square Container Lids

| NO. | COLOR | DESCRIPTION | SIZE | U.S. DIMENSIONS | U.S. SHIP WT/CTN | METRIC DIMENSIONS | METRIC SHIP WT/CTN | CASE PACK |
|-------------|--------|----------------------------------|----------------------|-------------------------------|------------------|----------------------------------|--------------------|-----------|
| FG650900WHT | White | Color-Coded Square Container Lid | Fits 2, 4, 6, & 8 qt | 9.00" l x 8.47" w x 0.51" h | 3.09 lb | 228.63 mm x 215.14 mm x 12.95 mm | 1.40 kg | 12 |
| 1980200 | Red | Color-Coded Square Container Lid | Fits 2, 4, 6, & 8 qt | 9.00" l x 8.47" w x 0.51" h | 3.09 lb | 228.63 mm x 215.14 mm x 12.95 mm | 1.40 kg | 12 |
| 1980301 | Green | Color-Coded Square Container Lid | Fits 2, 4, 6, & 8 qt | 9.00" l x 8.47" w x 0.51" h | 3.09 lb | 228.63 mm x 215.14 mm x 12.95 mm | 1.40 kg | 12 |
| 1980302 | Blue | Color-Coded Square Container Lid | Fits 2, 4, 6, & 8 qt | 9.00" l x 8.47" w x 0.51" h | 3.09 lb | 228.63 mm x 215.14 mm x 12.95 mm | 1.40 kg | 12 |
| 1980303 | Yellow | Color-Coded Square Container Lid | Fits 2, 4, 6, & 8 qt | 9.00" l x 8.47" w x 0.51" h | 3.09 lb | 228.63 mm x 215.14 mm x 12.95 mm | 1.40 kg | 12 |
| 1980304 | Purple | Color-Coded Square Container Lid | Fits 2, 4, 6, & 8 qt | 9.00" l x 8.47" w x 0.51" h | 3.09 lb | 228.63 mm x 215.14 mm x 12.95 mm | 1.40 kg | 12 |
| FG652300WHT | White | Color-Coded Square Container Lid | Fits 12, 18, & 22 qt | 11.56" l x 10.68" w x 0.52" h | 2.26 lb | 293.67 mm x 271.25 mm x 13.21 mm | 1.02 kg | 6 |
| 1980307 | Red | Color-Coded Square Container Lid | Fits 12, 18, & 22 qt | 11.56" l x 10.68" w x 0.52" h | 2.26 lb | 293.67 mm x 271.25 mm x 13.21 mm | 1.02 kg | 6 |
| 1980308 | Green | Color-Coded Square Container Lid | Fits 12, 18, & 22 qt | 11.56" l x 10.68" w x 0.52" h | 2.26 lb | 293.67 mm x 271.25 mm x 13.21 mm | 1.02 kg | 6 |
| 1980309 | Blue | Color-Coded Square Container Lid | Fits 12, 18, & 22 qt | 11.56" l x 10.68" w x 0.52" h | 2.26 lb | 293.67 mm x 271.25 mm x 13.21 mm | 1.02 kg | 6 |
| 1980310 | Yellow | Color-Coded Square Container Lid | Fits 12, 18, & 22 qt | 11.56" l x 10.68" w x 0.52" h | 2.26 lb | 293.67 mm x 271.25 mm x 13.21 mm | 1.02 kg | 6 |
| 1980311 | Purple | Color-Coded Square Container Lid | Fits 12, 18, & 22 qt | 11.56" l x 10.68" w x 0.52" h | 2.26 lb | 293.67 mm x 271.25 mm x 13.21 mm | 1.02 kg | 6 |

When ordering products with **BOLD** color codes, please specify color code after the product number. Refer to the Standard Color Guide at the back of the catalog.

UTILITY REFUSE AND RECYCLING

DECORATIVE REFUSE

CLEANING & SAFETY

MATERIAL HANDLING

WASHROOM

FOODSERVICE

ACCESSORIES & INDEX

Round Storage Containers

Store food safely and efficiently.

- Stackable handled containers available in white polyethylene or semi-clear polypropylene for better visibility
- Temperature range: 35°F to 150°F (2°C to 66°C)
- NSF 3-A and NSF 2-certified
- Dishwasher-safe



Semi-Clear Polypropylene Round Storage Containers

| NO. | COLOR | DESCRIPTION | U.S. CAPACITY | U.S. DIMENSIONS | U.S. SHIP WT/CTN | METRIC CAPACITY | METRIC DIMENSIONS | METRIC SHIP WT/CTN | CASE PACK |
|----------|-------|-----------------------------------|---------------|-----------------------|------------------|-----------------|-----------------------|--------------------|-----------|
| FG572024 | CLR | Round Storage Container | 2 qt | 8.5" dia x 4" h | 4.3 lb | 1.9 L | 21.6 cm dia x 10.2 cm | 2 kg | 12 |
| FG572124 | CLR | Round Storage Container | 4 qt | 8.5" dia x 7.75" h | 7.4 lb | 3.8 L | 21.6 cm dia x 19.7 cm | 3.4 kg | 12 |
| FG572324 | CLR | Round Storage Container | 6 qt | 10" dia x 7.63" h | 8.7 lb | 5.7 L | 25.4 cm dia x 19.4 cm | 3.9 kg | 12 |
| FG572424 | CLR | Round Storage Container | 8 qt | 10" dia x 10.63" h | 11.9 lb | 7.6 L | 25.4 cm dia x 27 cm | 5.4 kg | 12 |
| FG572624 | CLR | Round Storage Container | 12 qt | 13.13" dia x 8.13" h | 8.5 lb | 11.4 L | 33.3 cm dia x 20.6 cm | 3.9 kg | 6 |
| FG572724 | CLR | Round Storage Container | 18 qt | 13.13" dia x 11.88" h | 11.6 lb | 17 L | 33.3 cm dia x 30.2 cm | 5.3 kg | 6 |
| FG572824 | CLR | Round Storage Container | 22 qt | 13.13" dia x 14" h | 14.8 lb | 20.8 L | 33.3 cm dia x 35.6 cm | 6.7 kg | 6 |
| FG572924 | CLR | Round Storage Container with Bail | 22 qt | 13.13" dia x 14" h | 15.9 lb | 20.8 L | 33.3 cm dia x 35.6 cm | 7.2 kg | 6 |

Polyethylene Round Storage Containers

| NO. | COLOR | DESCRIPTION | U.S. CAPACITY | U.S. DIMENSIONS | U.S. SHIP WT/CTN | METRIC CAPACITY | METRIC DIMENSIONS | METRIC SHIP WT/CTN | CASE PACK |
|----------|-------|-----------------------------------|---------------|-----------------------|------------------|-----------------|-----------------------|--------------------|-----------|
| FG572000 | WHT | Round Storage Container | 2 qt | 8.5" dia x 4" h | 4.3 lb | 1.9 L | 21.6 cm dia x 10.2 cm | 2 kg | 12 |
| FG572100 | WHT | Round Storage Container | 4 qt | 8.5" dia x 7.75" h | 7.4 lb | 3.8 L | 21.6 cm dia x 19.7 cm | 3.4 kg | 12 |
| FG572300 | WHT | Round Storage Container | 6 qt | 10" dia x 7.63" h | 8.7 lb | 5.7 L | 25.4 cm dia x 19.4 cm | 3.9 kg | 12 |
| FG572400 | WHT | Round Storage Container | 8 qt | 10" dia x 10.63" h | 11.9 lb | 7.6 L | 25.4 cm dia x 27 cm | 5.4 kg | 12 |
| FG572600 | WHT | Round Storage Container | 12 qt | 13.13" dia x 8.13" h | 8.5 lb | 11.4 L | 33.3 cm dia x 20.6 cm | 3.9 kg | 6 |
| FG572700 | WHT | Round Storage Container | 18 qt | 13.13" dia x 11.88" h | 11.6 lb | 17 L | 33.3 cm dia x 30.2 cm | 5.3 kg | 6 |
| FG572800 | WHT | Round Storage Container | 22 qt | 13.13" dia x 14" h | 15.2 lb | 20.8 L | 33.3 cm dia x 35.6 cm | 6.9 kg | 6 |
| FG572900 | WHT | Round Storage Container with Bail | 22 qt | 13.13" dia x 14" h | 16.6 lb | 20.8 L | 33.3 cm dia x 35.6 cm | 7.5 kg | 6 |

Round Container Lids

Use color-coded storage containers and lids to keep uncooked foods like raw meat separate from ready-to-eat foods.

- Secure, leak-resistant lids
- Positive-lock lids (double-wall seal) with pull tabs



COLORS AVAILABLE: 

1980337

1980338

1980339

FG572200YEL

1980257

Round Container Lids

| NO. | COLOR | DESCRIPTION | SIZE | U.S. DIMENSIONS | U.S. SHIP WT/CTN | METRIC DIMENSIONS | METRIC SHIP WT/CTN | CASE PACK |
|-------------|--------|---------------------------------|------------|-------------------------------|------------------|----------------------------------|--------------------|-----------|
| 1980337 | Red | Color-Coded Round Container Lid | Fits 4 qt | 8.80" l x 8.80" w x 0.90" h | 2.47 lb | 223.47 mm x 223.47 mm x 22.86 mm | 1.12 kg | 12 |
| 1980338 | Green | Color-Coded Round Container Lid | Fits 4 qt | 8.80" l x 8.80" w x 0.90" h | 2.47 lb | 223.47 mm x 223.47 mm x 22.86 mm | 1.12 kg | 12 |
| 1980339 | Blue | Color-Coded Round Container Lid | Fits 4 qt | 8.80" l x 8.80" w x 0.90" h | 2.47 lb | 223.47 mm x 223.47 mm x 22.86 mm | 1.12 kg | 12 |
| FG572200YEL | Yellow | Color-Coded Round Container Lid | Fits 4 qt | 8.80" l x 8.80" w x 0.90" h | 2.47 lb | 223.47 mm x 223.47 mm x 22.86 mm | 1.12 kg | 12 |
| 1980257 | Purple | Color-Coded Round Container Lid | Fits 4 qt | 8.80" l x 8.80" w x 0.90" h | 2.47 lb | 223.47 mm x 223.47 mm x 22.86 mm | 1.12 kg | 12 |
| 1980260 | Red | Color-Coded Round Container Lid | Fits 8 qt | 10.30" l x 10.30" w x 1.00" h | 3.23 lb | 261.57 mm x 261.57 mm x 25.40 mm | 1.47 kg | 12 |
| 1980381 | Green | Color-Coded Round Container Lid | Fits 8 qt | 10.30" l x 10.30" w x 1.00" h | 3.23 lb | 261.57 mm x 261.57 mm x 25.40 mm | 1.47 kg | 12 |
| 1980382 | Blue | Color-Coded Round Container Lid | Fits 8 qt | 10.30" l x 10.30" w x 1.00" h | 3.23 lb | 261.57 mm x 261.57 mm x 25.40 mm | 1.47 kg | 12 |
| FG572500YEL | Yellow | Color-Coded Round Container Lid | Fits 8 qt | 10.30" l x 10.30" w x 1.00" h | 3.23 lb | 261.57 mm x 261.57 mm x 25.40 mm | 1.47 kg | 12 |
| 1980384 | Purple | Color-Coded Round Container Lid | Fits 8 qt | 10.30" l x 10.30" w x 1.00" h | 3.23 lb | 261.57 mm x 261.57 mm x 25.40 mm | 1.47 kg | 12 |
| 1980387 | Red | Color-Coded Round Container Lid | Fits 12 qt | 13.52" l x 13.52" w x 1.20" h | 3.35 lb | 343.48 mm x 343.48 mm x 30.48 mm | 1.52 kg | 6 |
| 1980388 | Green | Color-Coded Round Container Lid | Fits 12 qt | 13.52" l x 13.52" w x 1.20" h | 3.35 lb | 343.48 mm x 343.48 mm x 30.48 mm | 1.52 kg | 6 |
| 1980389 | Blue | Color-Coded Round Container Lid | Fits 12 qt | 13.52" l x 13.52" w x 1.20" h | 3.35 lb | 343.48 mm x 343.48 mm x 30.48 mm | 1.52 kg | 6 |
| FG573000YEL | Yellow | Color-Coded Round Container Lid | Fits 12 qt | 13.52" l x 13.52" w x 1.20" h | 3.35 lb | 343.48 mm x 343.48 mm x 30.48 mm | 1.52 kg | 6 |
| 1980391 | Purple | Color-Coded Round Container Lid | Fits 12 qt | 13.52" l x 13.52" w x 1.20" h | 3.35 lb | 343.48 mm x 343.48 mm x 30.48 mm | 1.52 kg | 6 |



Heavy-Duty Hot and Cold Food Pans

Streamline your operations for storage, preparation, cooking, and serving.

- Break-resistant – won't rust, dent, or bend
- Odor-resistant
- Stain-resistant
- Nonstick surfaces for easy food release and cleaning
- FDA-approved for food contact
- NSF/ANSI/3-A and 2-Certified
- EU-Certified
- Designed to EN 631-1 C.E.N. Standard*
- Soft-sealing and secure sealing lids are temperature rated from -20°F to 150°F (-29°C to 66°C)
- Dishwasher-safe



Cold Food Pans

- Temperature rated: -40°F to 212°F (-40°C to 100°C)
- Not for use in steam table wells

Hot Food Pans

- Temperature rated: -40°F to 375°F (-40°C to 191°C)
- Steam table well-, oven-** and microwave-safe
- Not for use with open flame
- Cooler to the touch than metal
- Approved for use in continuous motion pot-washing systems



Hot pans are cool to the touch.



Nonstick surfaces for easy food release and cleaning.



LIDS FOR EVERY NEED

1 PEG HOLE COVER WITH HANDLE

Peg hole allows pan to be hung and dry faster, helping to prevent health risks from standing water. Rubbermaid Commercial Product's peg hole solution is the only NSF-certified hanging solution on the market.

2 NOTCHED COVER WITH HANDLE

NSF-certified notch allows spoon to be easily available while food remains covered. Notch keeps spoon handle out of food, complying with FDA Food Code.

3 SOFT-SEALING LID

Seals on insert pan help reduce airflow to food, therefore maintaining food quality. No overlap on food pans allows easy use in transport.

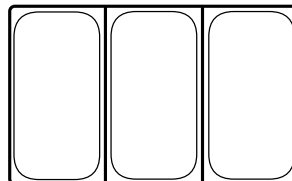

*DESIGNED TO EN 631-1 C.E.N. STANDARD

Developed by the European Committee for Standardization and based on a gastronorm modular system, ensures compatibility of the pans with other kitchen equipment.

**Oven-safe up to 375°F (191°C).









FG117P00 Clear

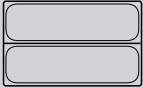

FG217P00 Amber



FOOD PANS

| FOOD PANS | | | | | | | | | COLD PANS | | HOT PANS | |
|--|---|---------------|------------------|-----------------|------------------|-----------------|---------------------|-----------|-------------|----------|-------------|----------|
| U.S. SIZE | U.S. PAN DEPTH/ DESCRIPTION | U.S. CAPACITY | U.S. SHIP WT/CTN | METRIC SIZE | METRIC PAN DEPTH | METRIC CAPACITY | METRIC SHIP WT/ CTN | CASE PACK | ITEM NUMBER | COLOR | ITEM NUMBER | COLOR |
| Full Size 20 ¹³ / ₁₆ " l x 12 ¹³ / ₁₆ " w  | 2 1/2" | 9 qt | 12.8 lb | Full Size | 65 mm | 8.5 L | 5.8 kg | 6 | FG130P00 | CLR | FG230P00 | AMBR |
| | 4" | 13 3/4 qt | 17.87 lb | 530 mm x 325 mm | 100 mm | 13 L | 3.6 kg | 6 | FG131P00 | CLR | FG231P00 | AMBR |
| | 6" | 20 5/8 qt | 20.30 lb | | 150 mm | 19.5 L | 9.2 kg | 6 | FG132P00 | CLR | FG232P00 | AMBR |
| | 8" | 27 1/8 qt | 24.52 lb | | 200 mm | 25.7 L | 11.1 kg | 6 | FG133P00 | CLR | | |
| | Handled Cover | | 10.21 lb | | | | 4.6 kg | 6 | FG134P00 | CLR | FG234P00 | AMBR |
| | Handled Notched Cover | | 9.37 lb | | | | 4.3 kg | 6 | FG134P86 | CLR | | |
| Soft-Sealing Lid | | 12.13 lb | | | | 5.5 kg | 12 | FG147P00 | WHT | | | |
| 1/2 Size LONG 20 ¹³ / ₁₆ " l x 6 ³ / ₈ " w  | 2 1/2" | 3 3/8 qt | 8.33 lb | 1/2 Size LONG | 65 mm | 3.4 L | 3.8 kg | 6 | FG139P00 | CLR | FG239P00 | AMBR |
| | 4" | 5 1/4 qt | 9.40 lb | 530 mm x 162 mm | 100 mm | 5.2 L | 4.3 kg | 6 | FG140P00 | CLR | FG240P00 | AMBR |
| | Handled Cover | | 4.77 lb | | | | 2.2 kg | 6 | FG141P00 | CLR | FG241P00 | AMBR |
| 1/2 Size 12 ¹³ / ₁₆ " l x 10 ³ / ₈ " w  | 2 1/2" | 4 qt | 6.30 lb | 1/2 Size | 65 mm | 3.8 L | 2.9 kg | 6 | FG123P00 | CLR | FG223P00 | AMBR |
| | 4" | 6 3/8 qt | 7.65 lb | 325 mm x 265 mm | 100 mm | 6 L | 3.5 kg | 6 | FG124P00 | CLR | FG224P00 | AMBR |
| | 6" | 9 1/8 qt | 9.90 lb | | 150 mm | 8.8 L | 4.5 kg | 6 | FG125P00 | CLR | FG225P00 | AMBR |
| | 8" | 11 3/8 qt | 13.47 lb | | 200 mm | 10.8 L | 6.1 kg | 6 | FG126P00 | CLR | | |
| | Drain Tray | | 2.0 lb | | | | 0.9 kg | 6 | FG127P24* | CLR | FG127P00 | AMBR |
| | Handled Cover w/ Peg Hole | | 4.3 lb | | | | 2 kg | 6 | FG128P23 | CLR | FG228P23 | AMBR |
| | Handled Notched Cover | | 4.3 lb | | | | 2 kg | 6 | FG128P86 | CLR | FG228P86 | AMBR |
| Soft-Sealing Lid | | 6.75 lb | | | | 3.1 kg | 12 | FG146P00 | WHT | | | |
| 1/2 Size 20 ¹³ / ₁₆ " l x 6 ⁷ / ₈ " w  | 2 1/2" | 2 5/8 qt | 4.40 lb | 1/2 Size | 65 mm | 2.5 L | 2 kg | 6 | FG116P00 | CLR | FG216P00 | AMBR |
| | 4" | 4 qt | 5.50 lb | 325 mm x 176 mm | 100 mm | 3.8 L | 2.5 kg | 6 | FG117P00 | CLR | FG217P00 | AMBR |
| | 6" | 5 3/8 qt | 7.30 lb | | 150 mm | 5.1 L | 3.3 kg | 6 | FG118P00 | CLR | FG218P00 | AMBR |
| | 8" | 7 3/8 qt | 9.60 lb | | 200 mm | 7 L | 4.4 kg | 6 | FG119P00 | CLR | | |
| | Drain Tray | | 1.50 lb | | | | 0.7 kg | 6 | FG120P24* | CLR | FG120P00 | AMBR |
| | Handled Cover w/ Peg Hole | | 2.77 lb | | | | 1.3 kg | 6 | FG121P23 | CLR | FG221P23 | AMBR |
| | Handled Notched Cover | | 3.10 lb | | | | 1.4 kg | 6 | FG121P86 | CLR | FG221P86 | AMBR |
| | w/ Peg Hole | | | | | | | | | | | |
| | Soft-Sealing Lid | | 3.75 lb | | | | 1.7 kg | 12 | FG145P00 | WHT | | |
| | 1/4 Size 10 ³ / ₈ " l x 6 ³ / ₈ " w  | 2 1/2" | 1 3/8 qt | 3.4 lb | 1/4 Size | 65 mm | 1.6 L | 1.5 kg | 6 | FG110P00 | CLR | FG210P00 |
| 4" | | 2 1/2 qt | 4.4 lb | 265 mm x 162 mm | 100 mm | 2.4 L | 2 kg | 6 | FG111P00 | CLR | FG211P00 | AMBR |
| 6" | | 4 qt | 5.6 lb | | 150 mm | 3.8 L | 2.5 kg | 6 | FG112P00 | CLR | FG212P00 | AMBR |
| Drain Tray | | | 0.9 lb | | | | 0.4 kg | 6 | FG113P24 | CLR | FG113P00 | AMBR |
| Handled Cover | | | 2.1 lb | | | | 1 kg | 6 | FG114P00 | CLR | FG214P00 | AMBR |
| Handled Notched Cover | | | 2.1 lb | | | | 1 kg | 6 | FG114P86 | CLR | FG214P86 | AMBR |
| Soft-Sealing Lid | | 2.54 lb | | | | 1.2 kg | 12 | FG144P00 | WHT | | | |
| 1/6 Size 6 ⁷ / ₈ " l x 6 ³ / ₈ " w  | 2 1/2" | 1 1/8 qt | 2.57 lb | 1/6 Size | 65 mm | 1.1 L | 1.2 kg | 6 | FG104P00 | CLR | FG204P00 | AMBR |
| | 4" | 1 3/8 qt | 3.0 lb | 176 mm x 162 mm | 100 mm | 1.6 L | 1.4 kg | 6 | FG105P00 | CLR | FG205P00 | AMBR |
| | 6" | 2 1/2 qt | 3.9 lb | | 150 mm | 2.4 L | 1.8 kg | 6 | FG106P00 | CLR | FG206P00 | AMBR |
| | Drain Tray | | | | | | | | | | FG345600 | AMBR |
| | Handled Cover w/ Peg Hole | | 1.47 lb | | | | 0.7 kg | 6 | FG108P23 | CLR | FG208P23 | AMBR |
| | Handled Notched Cover | | 1.5 lb | | | | 0.7 kg | 6 | FG108P86 | CLR | FG208P86 | AMBR |
| w/ Peg Hole | | | | | | | | | | | | |
| Soft-Sealing Lid | | 3.0 lb | | | | 1.4 kg | 12 | FG143P00 | WHT | | | |
| 1/6 Size 6 ⁷ / ₈ " l x 4 ³ / ₈ " w  | 2 1/2" | 3/8 qt | 2.0 lb | 1/6 Size | 65 mm | .6 L | 0.9 kg | 6 | FG100P00 | CLR | FG200P00 | AMBR |
| | 4" | 3/8 qt | 2.19 lb | 176 mm x 108 mm | 100 mm | .8 L | 1 kg | 6 | FG101P00 | CLR | FG201P00 | AMBR |
| | 6" | 1 1/16 qt | 2.8 lb | 176 mm x 108 mm | 149 mm | 1.2 L | 1.3 kg | 6 | 2045316 | CLR | | |
| | Drain Tray | | 0.43 lb | 118 mm x 56 mm | 19 mm | | 0.2 kg | 6 | 2045317 | CLR | | |
| | Cover w/ Peg Hole | | 0.87 lb | | | | 0.4 kg | 6 | FG102P23 | CLR | FG202P23 | AMBR |
| | Notched Cover | | 0.90 lb | | | | 0.4 kg | 6 | FG102P86 | CLR | | |
| | Soft-Sealing Lid | | 1.2 lb | | | | 0.5 kg | 12 | FG142P00 | WHT | | |

*FG127P24 fits all but FG126P00

*FG120P24 fits all but FG119P00

UTILITY REFUSE AND RECYCLING

DECORATIVE REFUSE

CLEANING & SAFETY

MATERIAL HANDLING

WASHROOM

FOODSERVICE

ACCESSORIES & INDEX



High-Heat Scrapers and Spoons

All-purpose scrapers and spoons are a necessity in every kitchen.

- Silicone blade and nylon handle resist temperatures to 500°F/260°C and help prevent burns
- Clean-Rest™ feature keeps blade off countertops, reducing cross-contamination
- Notched scraper blade cleanly scrapes sides of pans
- Blades are stain-resistant and will not scratch pans
- NSF-certified and commercial dishwasher-safe

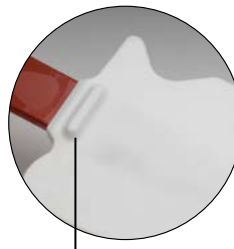

Clean-Rest™ reduces risk of cross-contamination.



Scraper Spoon



| NO. | COLOR | DESCRIPTION | U.S. DIMENSIONS | U.S. SHIP WT/CTN | METRIC DIMENSIONS | METRIC SHIP WT/CTN | CASE PACK |
|----------|-------------|-------------------------------------|-----------------|------------------|-------------------|--------------------|-----------|
| FG196200 | 0000 | Color Coded High-Heat Spatula (Red) | 9.5" l | 2.60 lb | 24.1 cm | 1.18 kg | 24 |
| 1981140 | Green | Color Coded High-Heat Spatula | 9.5" l | 2.60 lb | 24.1 cm | 1.18 kg | 12 |
| 1981141 | Blue | Color Coded High-Heat Spatula | 9.5" l | 2.60 lb | 24.1 cm | 1.18 kg | 12 |
| 1981142 | Yellow | Color Coded High-Heat Spatula | 9.5" l | 2.60 lb | 24.1 cm | 1.18 kg | 12 |
| 1981143 | Purple | Color Coded High-Heat Spatula | 9.5" l | 2.60 lb | 24.1 cm | 1.18 kg | 12 |
| FG196300 | 0000 | Color Coded High-Heat Spatula (Red) | 13.5" l | 3.94 lb | 34.3 cm | 1.79 kg | 24 |
| 1980417 | Green | Color Coded High-Heat Spatula | 13.5" l | 3.94 lb | 34.3 cm | 1.79 kg | 12 |
| 1980418 | Blue | Color Coded High-Heat Spatula | 13.5" l | 3.94 lb | 34.3 cm | 1.79 kg | 12 |
| 1980419 | Yellow | Color Coded High-Heat Spatula | 13.5" l | 3.94 lb | 34.3 cm | 1.79 kg | 12 |
| 1980420 | Purple | Color Coded High-Heat Spatula | 13.5" l | 3.94 lb | 34.3 cm | 1.79 kg | 12 |
| FG196400 | 0000 | High-Heat Scraper | 16.5" l | 7.03 lb | 41.9 cm | 3.2 kg | 24 |
| FG196600 | RED | High-Heat Spoon Scraper | 9.5" l | 3.31 lb | 24.1 cm | 1.5 kg | 24 |
| FG196700 | RED | High-Heat Spoon Scraper | 13.5" l | 6.58 lb | 34.3 cm | 3 kg | 24 |
| FG196800 | RED | High-Heat Spoon Scraper | 16.5" l | 7.11 lb | 41.9 cm | 3.2 kg | 24 |

Cold Scrapers and Spoons

Spoon, scrape, and spread with one easy tool.

- Blades are molded into handles for seamless construction that reduces buildup of dirt and bacteria
- Clean-Rest™ feature keeps blade off countertops, reducing cross-contamination
- NSF-certified and commercial dishwasher-safe

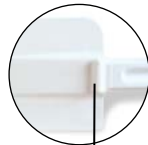

Clean-Rest™ reduces risk of cross-contamination.



Scraper Scraper-Icing Spoon



| NO. | COLOR | DESCRIPTION | U.S. DIMENSIONS | U.S. SHIP WT/CTN | METRIC DIMENSIONS | METRIC SHIP WT/CTN | CASE PACK |
|----------|-------------|----------------------|-----------------|------------------|-------------------|--------------------|-----------|
| FG190100 | 0000 | Scraper | 9.5" l | 4.0 lb | 24.1 cm | 1.8 kg | 36 |
| FG190500 | 0000 | Scraper | 13.5" l | 8.0 lb | 34.3 cm | 3.6 kg | 36 |
| FG190600 | 0000 | Scraper | 16.5" l | 12.0 lb | 41.9 cm | 5.4 kg | 36 |
| FG191300 | 0000 | Scraper-Icing Blade | 9.5" l | 4.0 lb | 24.1 cm | 1.8 kg | 36 |
| FG193300 | WHT | Spoon-Shaped Spatula | 9.5" l | 4.61 lb | 24.1 cm | 2.1 kg | 36 |
| FG193400 | WHT | Spoon-Shaped Spatula | 13.5" l | 9.22 lb | 34.3 cm | 4.2 kg | 36 |
| FG193800 | WHT | Spoon-Shaped Spatula | 16.5" l | 11.1 lb | 41.9 cm | 5.0 kg | 36 |

Measuring Cups and Spoons

- Made of FDA-compliant materials
- Capacities clearly engraved for easy identification
- Spoons are secured with detachable ring
- Accurate ingredient portioning to manage food costs
- Commercial dishwasher-safe



FG8316AS



FG8315AS



FG9G8200



| NO. | COLOR | DESCRIPTION | U.S. CAPACITY | U.S. SHIP WT/CTN | METRIC SHIP WT/CTN | CASE PACK |
|----------|------------|---------------------|--|------------------|--------------------|-----------|
| FG8315AS | WHT | Measuring Cup Set | Set includes: ¼, ⅓, ½, and 1 cups | 2.15 lb | 0.98 kg | 12 |
| FG8316AS | WHT | Measuring Spoon Set | Set includes: ¼ tsp, ⅓ tsp, ½ tsp, 1 tsp, ½ tbsp, and 1 tbsp | 1.0 lb | 0.45 kg | 12 |
| FG9G8200 | WHT | Measuring Scoop | ½ cup | 1.05 lb | 0.48 kg | 12 |

When ordering products with **BOLD** color codes, please specify color code after the product number. Refer to the Standard Color Guide at the back of the catalog.

UTILITY REFUSE AND RECYCLING

DECORATIVE REFUSE

CLEANING & SAFETY

MATERIAL HANDLING

WASHROOM

FOODSERVICE

ACCESSORIES & INDEX

Bouncer® Measuring Cups

Manage costly ingredients.

- Accurately measure liquid or dry ingredients to help save on food costs
- Break-resistant, crystal-clear material is durable
- Temperature range: -40°F to 212°F (-40°C to 100°C)
- Metric measurements marked in blue and cup measurements marked in red for easy-to-read measurements
- NSF-certified and commercial dishwasher-safe



| NO. | COLOR | DESCRIPTION | U.S. CAPACITY | U.S. SHIP WT/CTN | METRIC CAPACITY | METRIC SHIP WT/CTN | CASE PACK |
|----------|-------|------------------------|---------------|------------------|-----------------|--------------------|-----------|
| FG321000 | CLR | Bouncer® Measuring Cup | 1 cup | 2.0 lb | 0.2 L | 0.9 kg | 12 |
| FG321500 | CLR | Bouncer® Measuring Cup | 1 pt | 2.36 lb | 0.5 L | 1.1 kg | 6 |
| FG321600 | CLR | Bouncer® Measuring Cup | 1 qt | 3.30 lb | 0.9 L | 1.5 kg | 6 |
| FG321700 | CLR | Bouncer® Measuring Cup | 2 qt | 4.43 lb | 1.9 L | 2.0 kg | 6 |
| FG321800 | CLR | Bouncer® Measuring Cup | 4 qt | 10.0 lb | 3.8 L | 4.5 kg | 6 |

Bouncer® Scoops

Multipurpose scoops for use throughout food service operations.

- Durable crystal-clear material (FG288200, FG288400, FG288600) or break-resistant white polyethylene (FG288500) can be used for a variety of applications
- NSF-certified (FG288200, FG288400, FG288600, FG9F7500 and FG9F7600) and commercial dishwasher-safe
- Bouncer® Contour Scoop (FG9F7500 and FG9F7600) is designed for the ProSave® Ingredient Bin System; the contoured design keeps hands away from food, reducing cross-contamination



FG288400 / FG288200 / FG288600

Bouncer® Portioning Scoops

Maintain food safety while managing food costs.

- Hybrid scoop and measuring cup allow for portioning or measuring milliliters, cups, or ounces
- Anti-roll design to reduce risk of the handle rolling into the food and posing a contamination risk
- Break-resistant, crystal-clear material is durable
- Permanent textured gradations for dry and liquid measurements
- FG9G5100 and FG9G5200 are designed to fit ProSave® Shelf Ingredient Bins
- NSF-certified and commercial dishwasher-safe



Portioning Scoops



| NO. | COLOR | DESCRIPTION | U.S. CAPACITY | U.S. SHIP WT/CTN | METRIC CAPACITY | METRIC SHIP WT/CTN | CASE PACK |
|-----------|-------|---|---------------|------------------|-----------------|--------------------|-----------|
| FG288200* | CLR | Bouncer® Bar Scoop | 6 oz | 3.0 lb | 0.2 L | 1.4 kg | 12 |
| FG288400* | CLR | Bouncer® Utility Scoop | 32 oz | 6.4 lb | 0.9 L | 2.9 kg | 12 |
| FG288500 | WHT | Utility Scoop | 64 oz | 3.4 lb | 1.9 L | 1.5 kg | 6 |
| FG288600* | CLR | Bouncer® Utility Scoop | 64 oz | 5.1 lb | 1.9 L | 2.3 kg | 6 |
| FG9F7500* | CLR | Bouncer® Contour Scoop for FG360088, FG360288, FG360388 Ingredient Bins (32-oz scoop) | 32 oz | 4.2 lb | 0.9 L | 1.9 kg | 6 |
| FG9F7600* | CLR | Bouncer® Contour Scoop for FG360088, FG360288, FG360388 Ingredient Bins (64-oz scoop) | 64 oz | 6.2 lb | 1.9 L | 2.8 kg | 6 |
| FG9G5100 | CLR | Bouncer® Portioning Scoop – 2 Cup | 2 cup/16 oz | 3.2 lb | 500 ml | 1.5 kg | 12 |
| FG9G5200 | CLR | Bouncer® Portioning Scoop – 3 Cup | 3 cup/24 oz | 4.0 lb | 750 ml | 1.8 kg | 12 |
| FG9G5300 | CLR | Bouncer® Portioning Scoop – 4 Cup | 4 cup/32 oz | 5.0 lb | 1000 ml | 2.3 kg | 12 |
| FG9G5400 | CLR | Bouncer® Portioning Scoop – 8 Cup | 8 cup/64 oz | 4.0 lb | 2000 ml | 1.8 kg | 6 |

*Certified to NSF Std. 2.

BRUTE® GreensKeeper® Containers

For cleaning and storing any fruit or vegetable.

- All-in-one wash, drain, crisp, and storage system that aids compliance with HACCP guidelines
- Removable dolly allows easy transport
- Assists in complying with FDA Code 3-302, 15 for Washing Fruits and Vegetables



FG263600

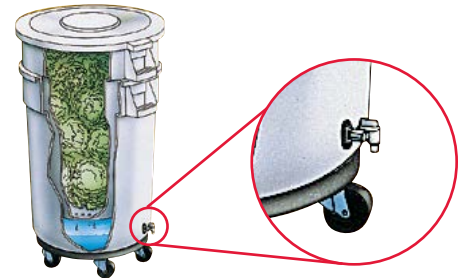

| NO. | COLOR | DESCRIPTION | U.S. CAPACITY | U.S. DIMENSIONS | U.S. SHIP WT/CTN | METRIC CAPACITY | METRIC DIMENSIONS | METRIC SHIP WT/CTN | LETTUCE HEADS | CASE PACK |
|----------|-------|--|---------------|---------------------|------------------|-----------------|-----------------------|--------------------|---------------|-----------|
| FG262400 | WHT | GreensKeeper® Container with Lid and Dolly | 20 gal | 22.5" dia x 33.5" h | 21.0 lb | 75.7 L | 57.2 cm dia x 85.1 cm | 9.53 kg | 27-30 | 1 |
| FG263600 | WHT | GreensKeeper® Container with Lid and Dolly | 32 gal | 25" dia x 38.5" h | 29.1 lb | 121.1 L | 63.5 cm dia x 97.8 cm | 13.2 kg | 49-52 | 1 |



Premium Digital Portion Control Scale

Save money on high cost foods with digital portioning.

- Dishwasher-safe removable platform and outer housing
- Reads in pounds by fractional and decimal ounces and grams
- Temperature-compensated load cell for use in refrigerated prep rooms
- Sealed inner chassis resists airborne contamination, slides out for easy cleaning
- Antimicrobial outer shell (resin models only)
- Includes AC adapter; 50-hour rechargeable battery (included)
- Also may be used with AA batteries (not included)
- 1812595 comes with an oversized platform accessory



Dishwasher Safe



1812595

| NO. | DESCRIPTION | INCREMENTS | U.S. CAPACITY | U.S. SHIP WT/CTN | METRIC CAPACITY | METRIC SHIP WT/CTN | CASE PACK |
|---------|---|-------------------------------|---------------|------------------|-----------------|--------------------|-----------|
| 1812595 | Premium Stainless Steel Dishwasher-Safe Digital Portion Control Scale (12 lb) | 0.005 lb, 0.1 oz, 1/4 oz, 1 g | 12.0 lb | 25.0 lb | 6000 g | 11.3 kg | 4 |

Digital Portion Control Scales

Save money on high-cost foods with digital portioning.

- Reads in pounds by fractional and decimal ounces and grams
- Temperature-compensated load cell for use in refrigerated prep rooms
- Antimicrobial protection on resin surfaces
- Available in 2-, 10-, 12-, and 24-lb capacities, with 200% overload protection
- Includes AC adapter
- High-Performance model uses AA batteries and Compact model uses AAA batteries



1812591

| NO. | DESCRIPTION | INCREMENTS | U.S. CAPACITY | U.S. SHIP WT/CTN | METRIC CAPACITY | METRIC SHIP WT/CTN | CASE PACK |
|---------|--|-------------------------------|---------------|------------------|-----------------|--------------------|-----------|
| 1812590 | High-Performance Digital Portion Control Scale (2 lb) | 0.005 lb, 0.1 oz, 1/4 oz, 1 g | 2.0 lb | 25.0 lb | 1000 g | 11.3 kg | 1 |
| 1812591 | High-Performance Digital Portion Control Scale (12 lb) | 0.005 lb, 0.1 oz, 1/4 oz, 1 g | 12.0 lb | 16.9 lb | 6000 g | 7.7 kg | 1 |
| 1812592 | High-Performance Digital Portion Control Scale (24 lb) | 0.01 lb, 0.2 oz, 1/2 oz, 10 g | 24.0 lb | 16.9 lb | 12000 g | 7.7 kg | 1 |
| 1812588 | Compact Digital Portion Control Scale (2 lb) | 0.1 oz, 1/4 oz, 1 g | 2.0 lb | 5.8 lb | 1000 g | 2.6 kg | 1 |
| 1812589 | Compact Digital Portion Control Scale (10 lb) | 0.1 oz, 1/4 oz, 1 g | 10.0 lb | 5.8 lb | 5000 g | 2.6 kg | 1 |

UTILITY REFUSE AND RECYCLING

DECORATIVE REFUSE

CLEANING & SAFETY

MATERIAL HANDLING

WASHROOM

FOODSERVICE

ACCESSORIES & INDEX

Premium Mechanical Portion Control Scales

All premium mechanical scales.

- Platform serves as a handle
- Precise calibration at factory eliminates need for field recalibration
- Color-coded lens identifies scale capacity "at a glance"
- Removable platform for easy cleaning and HACCP



FG605SRW

FG632SRW

Stainless Steel Scales, Dishwasher-Safe

- QuickStop feature stops needle quickly on weight
- 100% dishwasher-safe, no tools required to disassemble
- 30° angled, easy-to-read, shatter-resistant lens
- Rotating dial for multiple ingredient weighing



Stainless Steel Scales, Dishwasher-Safe

| NO. | DESCRIPTION | U.S. CAPACITY | INCREMENTS | PLATFORM SIZE | ROTATING DIAL | U.S. SHIP WT/CTN | OVER/UNDER DIAL | METRIC SHIP WT/CTN | CASE PACK |
|----------|--|---------------|------------|---------------|---------------|------------------|-----------------|--------------------|-----------|
| FG632SRW | Dishwasher-Safe Mechanical Portion Control Scale | 32 oz | ¼ oz | 6" x 5.25" | Yes | 30.0 lb | N/A | 13.6 kg | 1 |
| FG605SRW | Dishwasher-Safe Mechanical Portion Control Scale | 5 lb | ½ oz | 6" x 5.25" | Yes | 30.0 lb | N/A | 13.6 kg | 1 |

Steel with Baked-Enamel Finish, Hand-Wash Scale

| NO. | DESCRIPTION | U.S. CAPACITY | INCREMENTS | PLATFORM SIZE | ROTATING DIAL | U.S. SHIP WT/CTN | OVER/UNDER DIAL | METRIC SHIP WT/CTN | CASE PACK |
|---------|--|---------------|------------|---------------|---------------|------------------|-----------------|--------------------|-----------|
| FG832WQ | Washable Mechanical Portion Control Scale w/ QuickStop | 32 oz | ¼ oz | 9" x 9" | Yes | 42.0 lb | N/A | 19.1 kg | 1 |
| FG832W | Washable Mechanical Portion Control Scale | 32 oz | ¼ oz | 9" x 9" | Yes | 42.0 lb | N/A | 19.1 kg | 1 |
| FG810W | Washable Mechanical Portion Control Scale | 10 lb | 1 oz | 9" x 9" | Yes | 42.0 lb | N/A | 19.1 kg | 1 |
| FG840W | Washable Mechanical Portion Control Scale | 40 lb | 2 oz | 9" x 9" | Yes | 42.0 lb | N/A | 19.1 kg | 1 |

Dual-Read With U.S. And Metric Dial Scale, Washable

| NO. | DESCRIPTION | U.S. CAPACITY | INCREMENTS | PLATFORM SIZE | ROTATING DIAL | U.S. SHIP WT/CTN | METRIC CAPACITY | METRIC SHIP WT/CTN | CASE PACK |
|---------|---|---------------|------------|---------------|---------------|------------------|-----------------|--------------------|-----------|
| FG820BW | Washable Mechanical Portion Control Scale | 20 lb | 1 oz, 25 g | 9" x 9" | Yes | 42.0 lb | 9 kg | 19.1 kg | 1 |

Mechanical Portion Control Scales

- Stainless steel platform and stanchion serve as built-in handle
- Extra-thick anodized aluminum chassis for durability
- Color-coded lens identifies scale capacity "at a glance"



FGY32R

Rotating Dial Scales

| NO. | DESCRIPTION | U.S. CAPACITY | INCREMENTS | U.S. SHIP WT/CTN | PLATFORM SIZE | METRIC SHIP WT/CTN | CASE PACK |
|----------|----------------------------------|---------------|------------|------------------|---------------|--------------------|-----------|
| FGY16R | Mechanical Portion Control Scale | 16 oz | ¼ oz | 23.0 lb | 4.5" x 5.75" | 10.4 kg | 1 |
| FGY32R | Mechanical Portion Control Scale | 32 oz | ¼ oz | 23.0 lb | 4.5" x 5.75" | 10.4 kg | 1 |
| FGYG180R | Mechanical Portion Control Scale | 5 lb | ½ oz | 23.0 lb | 4.5" x 5.75" | 10.4 kg | 1 |
| FGYG425R | Mechanical Portion Control Scale | 25 lb | 2 oz | 23.0 lb | 4.5" x 5.75" | 10.4 kg | 1 |
| FGYG450R | Mechanical Portion Control Scale | 50 lb | 4 oz | 23.0 lb | 4.5" x 5.75" | 10.4 kg | 1 |

Compact Scales

| NO. | DESCRIPTION | U.S. CAPACITY | INCREMENTS | U.S. SHIP WT/CTN | PLATFORM SIZE | METRIC SHIP WT/CTN | CASE PACK |
|----------|---|---------------|------------|------------------|---------------|--------------------|-----------|
| FGK32 | Oven-Run Scale with 1 pt Measuring Cup | 32 oz | ¼ oz | 10.0 lb | 3.75" x 4.25" | 4.5 kg | 1 |
| FGK16SS | Compact Portion Control Scale | 16 oz | ¼ oz | 8.0 lb | 3.75" x 4.25" | 3.6 kg | 1 |
| FGKF16SS | Compact Portion Control Scale with Contoured Platform | 16 oz | ¼ oz | 10.0 lb | N/A | 4.5 kg | 1 |



Digital Receiving Utility Scales

Proper inventory control begins at the receiving door.

4010/4040 DIGITAL RECEIVING SCALES

- Rugged 18-gauge scale designed to handle heavy packages and containers
- Remote 1/2" LCD wall-mount display saves counter space and provides eye-level readout (9' cord reach) for employee-safe receiving
- Tare feature removes weight of container
- Low-profile, nonskid platform allows for easy weighing



FG401088 / FG404088

| NO. | DESCRIPTION | INCREMENTS | U.S. CAPACITY | U.S. SHIP WT/CTN | METRIC CAPACITY | METRIC SHIP WT/CTN | CASE PACK |
|----------|-------------------------|----------------|---------------|------------------|-----------------|--------------------|-----------|
| FG401088 | Digital Receiving Scale | 0.2 lb, 0.1 kg | 150.0 lb | 22.0 lb | 68 kg | 10 kg | 1 |
| FG404088 | Digital Receiving Scale | 0.5 lb, 0.2 kg | 400.0 lb | 22.0 lb | 180 kg | 10 kg | 1 |



Briefcase Utility Mechanical Receiving Scales

Low-profile receiving scale for foodservice, industrial, or office environments.

- Multiribbed platform is sturdy enough for bulky crates or heavy cartons
- Memory Lock™ feature locks in weight when dial is secure
- Low platform design allows for cartons to easily slide onto scale, improving employee safety
- Protected zero-adjust knob for precise zero reset
- Nonskid feet ensure weighing stability



FGP100S

| NO. | DESCRIPTION | INCREMENTS | U.S. CAPACITY | U.S. SHIP WT/CTN | METRIC CAPACITY | METRIC SHIP WT/CTN | CASE PACK |
|----------|---------------------------|------------|---------------|------------------|-----------------|--------------------|-----------|
| FGP100S | Briefcase Receiving Scale | 1 lb | 100.0 lb | 20.0 lb | N/A | 9.1 kg | 1 |
| FGP250S | Briefcase Receiving Scale | 1 lb | 250.0 lb | 20.0 lb | N/A | 9.1 kg | 1 |
| FGP250SS | Briefcase Receiving Scale | 1 lb | 250.0 lb | 20.0 lb | N/A | 9.1 kg | 1 |



Fixed Dial Platform Receiving Scales

Heavy-duty platform scale for tabletop weighing

- Temperature-compensated for use in refrigerated prep rooms and throughout the flow of food
- 30° angled, easy-to-read, shatter-resistant lens
- Heavy-duty steel construction
- Zero-adjust knob for precise zero reset



Steel with Baked-Enamel Finish

| NO. | DESCRIPTION | INCREMENTS | U.S. CAPACITY | U.S. SHIP WT/CTN | METRIC CAPACITY | METRIC SHIP WT/CTN | CASE PACK |
|----------|--|-------------|---------------|------------------|-----------------|--------------------|-----------|
| FG10B100 | Heavy-Duty Receiving Scale – Dual-Read | 4 oz, 100 g | 100.0 lb | 52.0 lb | 45 kg | 23.6 kg | 1 |
| FG10200S | 200 lb Heavy-Duty Receiving Scale | 8 oz | 200.0 lb | 59.0 lb | N/A | 26.8 kg | 1 |

UTILITY REFUSE AND RECYCLING

DECORATIVE REFUSE

CLEANING & SAFETY

MATERIAL HANDLING

WASHROOM

FOODSERVICE

ACCESSORIES & INDEX

ProServe® Ice Handling System

Promotes safe transfer of ice to reduce risk of cross-contamination and improves employee safety.

ProServe® ICE TOTE WITH BIN HOOK ADAPTER

Adapter keeps tote off floor, reducing cross-contamination.

- Bin hook adapter attaches to ice machine for ease of transfer and reduced back strain
- Elevated base hand grip reduces cross-contamination
- Nonnesting and fits in most commercial dishwashers

ProServe® 74-OZ SCOOP

WITH HAND GUARD AND HOLDER

15% greater capacity than standard scoop.

- Ice cavity under handle protects ice
- Reinforced leading edge
- Open air holder for reduced mold and bacteria growth
- Commercial dishwasher-safe



Ice flow from corners reduces spillage and improves safety.



| NO. | COLOR | DESCRIPTION | U.S. DIMENSIONS | U.S. SHIP WT/CTN | METRIC DIMENSIONS | METRIC SHIP WT/CTN | CASE PACK |
|-----------------------|-------|--|-----------------------------|------------------|-----------------------------|--------------------|-----------|
| FG9F4300 ¹ | 0000 | Scoop Holder | 10.1" l x 7.5" w x 5.4" h | 5.83 lb | 25.7 cm x 19.1 cm x 13.7 cm | 2.6 kg | 6 |
| FG9F5000 | TBLUE | 74-oz Scoop with Hand Guard | 12" l x 6.7" w x 7.7" h | 7.1 lb | 30.5 cm x 17 cm x 19.6 cm | 3.2 kg | 6 |
| FG9F5100 ¹ | TBLUE | 74-oz Scoop with Hand Guard and Holder | 12.1" l x 7.5" w x 8" h | 2.25 lb | 30.7 cm x 19.1 cm x 20.3 cm | 1 kg | 1 |
| FG9F5300 | TBLUE | Ice Tote | 10.5" l x 13.3" w x 22.1" h | 4.3 lb | 26.7 cm x 33.8 cm x 56.1 cm | 2 kg | 1 |
| FG9F5400 | TBLUE | Ice Tote with Bin Hook Adapter | 12.2" l x 13.3" w x 22.1" h | 4.0 lb | 31 cm x 33.8 cm x 56.1 cm | 1.8 kg | 1 |
| FG9F5600 | 0000 | Ice Bin Hook Adapter | 9.9" l x 11.8" w x 1.7" h | 2.9 lb | 25.1 cm x 30 cm x 4.3 cm | 1.3 kg | 6 |
| FG9F7300 | BLA | Ice Tote Lid | 12" l x 11.25" w x 2" h | 2.4 lb | 30.5 cm x 28.6 cm x 5.1 cm | 1.1 kg | 4 |

¹Holder is not NSF-listed.

BRUTE® "ICE ONLY" Container

Make ice safety a priority!

- Ensures safe ice handling and complies with HACCP guidelines
- No cracking, rusting, or chipping that could potentially contaminate ice
- Compliant with FDA Food Code 3-302.12 for Food Storage Containers with identifiably Common Food Name
- Handles and double-ribbed base allow easy lifting and dragging
- NSF-certified BRUTE® "ICE ONLY" container is durable and easy to clean



FG9F8600



| NO. | COLOR | DESCRIPTION | U.S. CAPACITY | U.S. DIMENSIONS | U.S. SHIP WT/CTN | METRIC CAPACITY | METRIC DIMENSIONS | METRIC SHIP WT/CTN | CASE PACK |
|----------|-------|----------------------|---------------|----------------------------------|------------------|-----------------|---------------------------------|--------------------|-----------|
| FG9F8600 | WHT | "ICE ONLY" Container | 10 gal | 15.63" dia x 15.63" l x 17.13" h | 19.0 lb | 37.85 cm | 39.7 cm dia x 39.7 cm x 43.5 cm | 8.6 kg | 6 |

UTILITY REFUSE AND RECYCLING

DECORATIVE REFUSE

CLEANING & SAFETY

MATERIAL HANDLING

WASHROOM

FOODSERVICE

ACCESSORIES & INDEX



ProServe® Lightweight Insulated Carriers

Four layers of thermal retention provide lightweight option for safely transporting food and beverages.

- Two inches of polyester insulation offers maximum thermal retention with no moisture and odor retention
- Keeps hot food hot and cold food cold safely for 4 hours
- ProServe® carriers are lighter than solid competitive products, decreasing risk of ergonomic stress
- Divider for FG9F1500 allows separation within carrier between hot and cold food storage
- Time temperature monitoring and labeling is easy with large identification window secured to each carrier



RIGID INTERIOR INSULATION

Lightweight and over 300% stronger than Styrofoam® polystyrene, Expanded Polypropylene (EPP) resists flaking, cleans easily, and provides uncompromising support.

REFLECTIVE VAPOR BARRIER

Helps maintain even temperature throughout the carrier, so foods maintain their ideal temperatures.

NONWOVEN POLYESTER INSULATION

Nearly an inch thick, it's the same insulation used in high-performance cold-weather gear. Will not retain moisture or odors.

COMMERCIAL-GRADE NYLON EXTERIOR

Strong (840 denier) nylon surrounds and protects the inner layers.



FG9G4000 Divider for FG9F1500 allows separation within carrier between hot and cold food storage and reduces risk of cross-contamination.

Heat Loss And Cold Retention

Weight Comparison

| NO. | HEAT LOSS AND COLD RETENTION | | WEIGHT COMPARISON | | |
|----------|------------------------------|-----------------------------|-------------------|-------------------------------------|------------|
| | HEAT LOSS IN °F/HR* (°C/HR) | HEAT GAIN IN °F/HR* (°C/HR) | PROSERVE® | TRADITIONAL EQUIVALENT [†] | DIFFERENCE |
| FG9F1200 | 5.5°F (3.1°C) | +0.2°F (0.1°C) | 10.6 lb | 24.3 lb | 56% |
| FG9F1300 | 6.0°F (3.3°C) | +0.4°F (0.2°C) | 14.9 lb | 28.7 lb | 48% |
| FG9F1400 | 5.7°F (3.2°C) | +0.3°F (0.2°C) | 17.0 lb | 29.5 lb | 52% |
| FG9F1500 | 5.8°F (3.2°C) | +0.5°F (0.3°C) | 6.3 lb | 26.5 lb | 76% |
| FG9F1600 | 5.2°F (2.9°C) | +0.6°F (0.3°C) | 11.1 lb | 27.5 lb | 60% |

*Average calculated on the basis of a 4-hour period

[†]Traditional rigid containers



FG9F1600



FG9F1500



FG9F1400



FG9F1300



FG9F1200

ProServe® Insulated Carriers

| NO. | COLOR | DESCRIPTION | U.S. DIMENSIONS | U.S. SHIP WT/CTN | METRIC DIMENSIONS | METRIC SHIP WT/CTN | PAN CAPACITY | CASE PACK |
|----------|--------------|--|----------------------------|------------------|-----------------------------|--------------------|--------------------------------|-----------|
| FG9F1200 | CGRAY | ProServe® Insulated End-Load, Full-Pan Carrier, Small | 27" l x 18.25" w x 16" h | 13.0 lb | 68.6 cm x 46.4 cm x 40.6 cm | 5.90 kg | Three 2½" or two 4" deep pans | 1 |
| FG9F1300 | CGRAY | ProServe® Insulated End-Load, Full-Pan Carrier, Medium | 27" l x 19.5" w x 22.5" h | 17.5 lb | 68.6 cm x 49.5 cm x 57.2 cm | 7.94 kg | Five 2½" or three 4" deep pans | 1 |
| FG9F1400 | CGRAY | ProServe® Insulated End-Load, Full-Pan Carrier, Large | 27" l x 21.5" w x 29" h | 20.1 lb | 68.6 cm x 54.6 cm x 73.7 cm | 9.12 kg | Seven 2½" or four 4" deep pans | 1 |
| FG9F1500 | CGRAY | ProServe® Insulated Top-Load, Half-Pan Carrier | 19" l x 16.75" w x 15" h | 8.3 lb | 48.3 cm x 42.5 cm x 38.1 cm | 3.76 kg | Three 2½" or two 4" deep pans | 1 |
| FG9F1600 | CGRAY | ProServe® Insulated Top-Load, Full-Pan Carrier | 28" l x 19.25" w x 19.5" h | 14.0 lb | 71.1 cm x 48.9 cm x 49.5 cm | 6.35 kg | Five 2½" or three 4" deep pans | 1 |

[†]Styrofoam® is a registered trademark of the Dow Chemical Company.

ProServe® Professional Delivery Bags

Reliable professional delivery bags for those on the go!

- Durable, commercial-grade nylon exterior will not deteriorate with use and offers years of performance
- Commercial-grade zippers and hook and loop closures protect food while metal grommets release excess steam to maintain food quality
- Large identification window allows for easy labeling of orders, dates, and temperatures
- Commercial dishwasher-safe, with hanging loop for proper drying



Metal grommets allow release of excess steam to prevent soggy food.



| NO. | COLOR | DESCRIPTION | BAG CAPACITY | U.S. DIMENSIONS | U.S. SHIP WT/CTN | METRIC DIMENSIONS | METRIC SHIP WT/CTN | CASE PACK |
|----------|-------|--|------------------------------|------------------------------|------------------|-----------------------------|--------------------|-----------|
| FG9F3500 | RED | ProServe® Pizza Delivery Bag, Small | Two 16" Pizzas | 18" l x 18" w x 5.25" h | 15.0 lb | 45.7 cm x 45.7 cm x 13.3 cm | 6.8 kg | 6 |
| FG9F3600 | RED | ProServe® Pizza Delivery Bag, Medium | Four 12" or Three 14" Pizzas | 18" l x 17.25" w x 7.75" h | 15.0 lb | 45.7 cm x 43.8 cm x 19.7 cm | 6.8 kg | 6 |
| FG9F3700 | RED | ProServe® Pizza Delivery Bag, Large | Four 16" or Three 18" Pizzas | 21.5" l x 19.75" w x 7.75" h | 18.0 lb | 54.6 cm x 50.2 cm x 19.7 cm | 8.2 kg | 6 |
| FG9F3800 | RED | ProServe® Pizza/Catering/Sandwich Delivery Bag, Medium | Six 12" to 14" Pizzas | 17" l x 17" w x 13" h | 13.5 lb | 43.2 cm x 43.2 cm x 33 cm | 6.1 kg | 4 |
| FG9F3900 | RED | ProServe® Pizza/Catering/Sandwich Delivery Bag, Large | Six 16" Pizzas | 19.75" l x 19.75" w x 13" h | 15.5 lb | 50.2 cm x 50.2 cm x 33 cm | 7.0 kg | 4 |
| FG9F4000 | RED | ProServe® Sandwich Delivery Bag | Fifteen 12" Sub Sandwiches | 15" l x 12" w x 12" h | 13.5 lb | 38.1 cm x 30.5 cm x 30.5 cm | 6.1 kg | 4 |

ProServe® Sheet Pan Rack System

Safely transport food from oven to freezer.

- Encourage employee safety with user-friendly handles and protective bumpers
- PanGuard™ locking bar secures pan, and extend base enhances stability to eliminate costly spills
- Easy-to-clean industrial-grade plastic top and bottom and chrome-plated side panels resist rust and corrosion
- Holds 18" x 26" sheet pans at the base, not the edges, for added support
- Heavy-duty thread guard, 5" dia. x 1¼" wide (12.7 cm), features two locking casters
- Vinyl Rack Cover (FG9F9000) reduces cross-contamination when used with ProServe® Rack System
- ProServe® Rack System is NSF-Certified



| NO. | COLOR | DESCRIPTION | PAN CAPACITY | U.S. DIMENSIONS | U.S. WEIGHT CAPACITY | U.S. SHIP WT/CTN | METRIC DIMENSIONS | METRIC WEIGHT CAPACITY | METRIC SHIP WT/CTN | CASE PACK |
|----------|-------|---|----------------------------------|-----------------------------|----------------------|------------------|------------------------------|------------------------|--------------------|-----------|
| FG9F9700 | BLA | ProServe® Standard Base Sheet Pan Rack | 26 Slots w/ 2" (5.08 cm) spacing | 23" l x 28" w x 69.63" h | 300.0 lb | 80.0 lb | 58.4 cm x 71.1 cm x 178.8 cm | 136.1 kg | 36.3 kg | 1 |
| FG9F9000 | CLR | Vinyl Rack Cover for FG9F9700, FG332000 Racks | N/A | 23.5" l x 29.5" w x 70.5" h | N/A | 5.5 lb | 59.7 cm x 74.9 cm x 179.1 cm | N/A | 2.5 kg | 1 |



ProServe® Racks and Carts

Increase efficiency by maximizing space, transportation, and storage.

- Versatile system specially designed to work with food pans, food boxes, and sheet pans
- Impact-resistant structural web plastic components stand up to the most demanding kitchens
- Racks and carts are designed with soft, round corners that are easy on the walls, doors, and equipment
- Stylish design and quiet handling moves food easily from kitchen to dining room, minimizing expensive labor costs
- USDA Meat and Poultry Group listed
- NSF-certified for cleanliness
- Casters are 5" (12.7 cm) nonmarking, swivel-plate design (two are lockable)



FG331600



FG332000



FG332400



Convenient disposal hole helps keep work surface clear of debris

FG331600

FG331500 / FG331700

Prep Cart-End Loader

Opening: 13" (33 cm)

Accommodates:

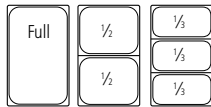

FG331600

Prep Cart-Side Loader

Opening: 26 1/8" (66.4 cm)

Accommodates:

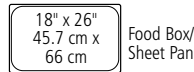

FG332400

Rack-Dual End Loader

Opening: 21 1/8" (53.5 cm)

Accommodates:



FG332000

Rack-End Loader

Opening: 19 3/8" (50.32 cm)

Accommodates:

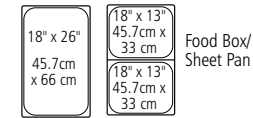

| NO. | COLOR | DESCRIPTION | PAN CAPACITY | U.S. DIMENSIONS | U.S. SHIP WT/CTN | METRIC DIMENSIONS | METRIC SHIP WT/CTN | CASE PACK |
|-----------------------|-------------|---|--------------|--------------------------------|------------------|------------------------------|--------------------|-----------|
| FG331500 ^a | BLA | ProServe® Prep Cart with Cutting Board (8-slot end loader for full-size insert pans) | 8 | 23.75" l x 18.63" w x 36.13" h | 44.8 lb | 60.3 cm x 47.3 cm x 91.8 cm | 20.3 kg | 1 |
| FG331600 ^a | BLA | ProServe® Prep Cart with Cutting Board (8-slot side loader for food boxes and sheet pans) | 8 | 31.75" l x 23.75" w x 36.13" h | 52.0 lb | 80.6 cm x 60.3 cm x 91.8 cm | 23.6 kg | 1 |
| FG331700 | OWHT | ProServe® Rack (18-slot end loader for full-size insert pans) | 18 | 23.75" l x 18.63" w x 67.88" h | 68.4 lb | 60.3 cm x 47.3 cm x 172.4 cm | 31 kg | 1 |
| FG331900 | OWHT | ProServe® Rack (18-slot side loader for food boxes and sheet pans) | 18 | 31.75" l x 23.75" w x 67.88" h | 72.3 lb | 80.6 cm x 60.3 cm x 172.4 cm | 32.8 kg | 1 |
| FG332000 | OWHT | ProServe® Rack (18-slot end loader for food boxes and sheet pans) | 18 | 28.75" l x 23.75" w x 67.88" h | 82.0 lb | 73 cm x 60.3 cm x 172.4 cm | 37.2 kg | 1 |
| FG332400 | OWHT | ProServe® Rack (18-slot dual loader for full-size insert pans) | 18 | 26.7" l x 28.75" w x 67.88" h | 82.0 lb | 67.8 cm x 73 cm x 172.4 cm | 37.2 kg | 1 |

^aIncludes NSF Food Zone-approved Max System™ Cutting Board

UTILITY REFUSE AND RECYCLING

DECORATIVE REFUSE

CLEANING & SAFETY

MATERIAL HANDLING

WASHROOM

FOODSERVICE

ACCESSORIES & INDEX

Bus/Tote Boxes

Built for long-lasting durability.

- Commercial-grade plastic has reinforced handles, bottom, and ribs for added strength and employee safety
- Rounded corners for easy cleaning
- NSF 3-A and 2-certified
- Commercial dishwasher-safe



FG335100



| NO. | COLOR | DESCRIPTION | U.S. CAPACITY | U.S. DIMENSIONS | U.S. SHIP WT/CTN | METRIC CAPACITY | METRIC DIMENSIONS | METRIC SHIP WT/CTN | CASE PACK |
|-----------|----------|--------------------------------------|---------------|-------------------------------|------------------|-----------------|-----------------------------|--------------------|-----------|
| FG334900* | WHT GRAY | Bus/Utility Box | 4½ gal | 20" l x 15" w x 5" h | 20.6 lb | 17.5 L | 50.8 cm x 38.1 cm x 12.7 cm | 9.3 kg | 12 |
| FG334992* | WHT GRAY | Bus/Utility Box, Bulk Pack | 4½ gal | 20" l x 15" w x 5" h | 444.1 lb | 17.5 L | 50.8 cm x 38.1 cm x 12.7 cm | 201.4 kg | 180 |
| FG335000* | BRN | Divided Bus/Utility Box | 7 gal | 21.5" l x 17.13" w x 7" h | 20.6 lb | 26.5 L | 54.6 cm x 43.5 cm x 17.8 cm | 9.3 kg | 6 |
| FG335100* | GRAY BRN | Undivided Bus/Utility Box | 7½ gal | 21.5" l x 17.13" w x 7" h | 17.6 lb | 28.9 L | 54.6 cm x 43.5 cm x 17.8 cm | 8 kg | 6 |
| FG335192* | GRAY BRN | Undivided Bus/Utility Box, Bulk Pack | 7½ gal | 21.5" l x 17.13" w x 7" h | 335.0 lb | 28.9 L | 54.6 cm x 43.5 cm x 17.8 cm | 152 kg | 100 |
| FG369000* | WHT | Food/Tote Box | 11 qt | 14.38" l x 12.38" w x 5.38" h | 6.7 lb | 10.4 L | 36.5 cm x 31.4 cm x 13.7 cm | 3 kg | 6 |
| FG364800 | GRAY | Lid for FG334900 Bus/Utility Box | N/A | 22" l x 16.5" w x 0.75" h | 18.0 lb | N/A | 55.9 cm x 41.9 cm x 1.9 cm | 8.2 kg | 12 |
| FG361600* | WHT | Lid for FG369000 Food/Tote Box | N/A | 15" l x 12.75" w | 2.9 lb | N/A | 38.1 cm x 32.4 cm | 1.3 kg | 6 |

*Certified to NSF Std. 2 for food contact. *Not NSF-certified.

Cutlery Bin

Safely stores and transports cutlery to minimize employee injuries.

- Made of durable, commercial-grade plastic
- Ribbed design and special resin finish for strength
- Ideal for storing, dispensing, and transporting silverware and condiment packets
- NSF-certified and commercial dishwasher-safe



| NO. | COLOR | DESCRIPTION | U.S. DIMENSIONS | U.S. SHIP WT/CTN | METRIC DIMENSIONS | METRIC SHIP WT/CTN | CASE PACK |
|----------|-------|-----------------------------|------------------------------|------------------|--------------------------|--------------------|-----------|
| FG336200 | GRAY | Cutlery Bin, 4 Compartments | 21.25" l x 11.5" w x 3.75" h | 19.1 lb | 54 cm x 29.2 cm x 9.5 cm | 8.7 kg | 12 |

Bouncer® Pitchers

Designed for safety and lower replacement costs.

- Reduce potential contamination with durable crystal-clear pitchers that resist chipping and breaking
- Drip-proof spout
- Lighter weight for employee safety and less costly than glass
- NSF-certified and commercial dishwasher-safe



FG333400



FG333800

| NO. | COLOR | DESCRIPTION | U.S. CAPACITY | U.S. SHIP WT/CTN | METRIC CAPACITY | METRIC SHIP WT/CTN | CASE PACK |
|----------|-----------|---------------------|---------------|------------------|-----------------|--------------------|-----------|
| FG333100 | CLR | Bouncer® II Pitcher | 48 oz | 6.67 lb | 1.4 L | 3 kg | 6 |
| FG333400 | CLR | Bouncer® II Pitcher | 60 oz | 6.49 lb | 1.8 L | 2.9 kg | 6 |
| FG333500 | CLR | Bouncer® Pitcher | 48 oz | 4.86 lb | 1.4 L | 2.2 kg | 6 |
| FG333600 | CLR | Bouncer® Pitcher | 32 oz | 3.0 lb | 0.9 L | 1.4 kg | 6 |
| FG333700 | CLR | Bouncer® Pitcher | 54 oz | 5.49 lb | 1.6 L | 2.5 kg | 6 |
| FG333800 | CLR, GOLD | Bouncer® Pitcher | 60 oz | 5.72 lb | 1.8 L | 2.6 kg | 6 |
| FG333900 | CLR | Bouncer® Pitcher | 72 oz | 6.63 lb | 2.1 L | 3 kg | 6 |



Sturdy Chair™ Youth Seats

Sturdy Chair™ Youth Seats make safety and cleanliness a priority for your youngest patrons.

- Contemporary design with Microban® technology makes it easier to clean than wood
- Microban® provides allover protection from bacteria growth that can cause odors and staining; complies with FDA standards
- Meets ASTM 404-08, TUV, and European safety standards
- Stackable design makes for easy storage
- Fits under standard table without tray
- 3-point harness with one-hand release



A new federal standard (ASTM F404-18) has been approved by the Consumer Product Safety Commission to improve the safety of high chairs in the United States. This will go into effect on all high chairs manufactured or imported after June 19, 2019. The Sturdy Chair™ Youth Seat is compliant with all ASTM standards.



FG780508PLAT



*2006 Rubbermaid Study



FG781588PLAT



FG781588DGRN

1819680

FG781588BLA



FG780608PLAT



FG780608BLA



1819679



FG780508DGRN

| NO. | COLOR | DESCRIPTION | U.S. DIMENSIONS | U.S. SHIP WT/CTN | METRIC DIMENSIONS | METRIC SHIP WT/CTN | CASE PACK |
|----------|-----------------------------|--|-------------------------------|------------------|-----------------------------|--------------------|-----------|
| FG780508 | DGRN, PLAT, BLA | Sturdy Chair™ Youth Seat with Wheels | 23.5" l x 23.38" w x 29.75" h | 18.0 lb | 59.7 cm x 59.4 cm x 75.6 cm | 8.2 kg | 1 |
| FG780608 | DGRN, PLAT, BLA | Sturdy Chair™ Youth Seat without Wheels | 23.5" l x 23.5" w x 29.75" h | 18.0 lb | 59.7 cm x 59.7 cm x 75.6 cm | 8.2 kg | 1 |
| FG781408 | DGRN, PLAT, BLA | Sturdy Chair™ Youth Seat, RTA (ready to assemble), No Wheels | 23.5" l x 23.5" w x 29.75" h | 17.0 lb | 59.7 cm x 59.7 cm x 75.6 cm | 7.7 kg | 1 |
| 1819679 | Brown | Sturdy Chair™ Youth Seat, RTA (ready to assemble), No Wheels | 23.5" l x 23.5" w x 29.75" h | 17.0 lb | 59.7 cm x 59.7 cm x 75.6 cm | 7.7 kg | 1 |
| FG781588 | DGRN, PLAT, RED, BLA | Tray for FG780508, FG780608, and FG781408 Chairs | 11.5" l x 18.5" w x 3.25" h | 2.5 lb | 29.2 cm x 47 cm x 8.3 cm | 1.1 kg | 1 |
| 1819680 | Brown | Tray for FG780508, FG780608, and FG781408 Chairs | 11.5" l x 18.5" w x 3.25" h | 2.5 lb | 29.2 cm x 47 cm x 8.3 cm | 1.1 kg | 1 |

MICROBAN® is a registered trademark of Microban Products Company.
©2006 Microban Products Company. All rights reserved. www.microban.com

Microban® protection does not protect user from foodborne illness and is not a substitute for normal cleaning practices.
**Time lapse image.

UTILITY REFUSE AND RECYCLING

DECORATIVE REFUSE

CLEANING & SAFETY

MATERIAL HANDLING

WASHROOM

FOODSERVICE

ACCESSORIES & INDEX

NEW

HIGH CHAIR REGULATION EFFECTIVE JUNE 19th, 2019

A new federal standard (ASTM F404-18) has been approved by the Consumer Product Safety Commission to improve the safety of high chairs in the United States. This regulation will go into effect on all high chairs manufactured or imported after June 19, 2019.



ALL RCP HIGH CHAIRS ARE COMPLIANT WITH ASTM STANDARDS

ALL HIGH CHAIRS MUST MEET THE CRITERIA BELOW:



ACTIVE THREE-POINT RESTRAINT

An active three-point restraint system is required.



PERMANENT T-BAR RESTRAINT

T-Bar must remain in fixed position at all times.



WARNING LABELS

Warning label must communicate hazards and be clearly visible to consumer.



HIGH CHAIR STABILITY

Must not tip over when pulled forward, backward, or sideways by specified force.



- Microban® antimicrobial protection helps prevent the growth of stain- and-odor causing bacteria
- Microban® protection is built into the chair during the manufacturing process and will not wash or wear off during the life of the chair
- Sturdy Chair™ looks newer longer with built-in Microban® antimicrobial protection

REPRESENTATIVE OF ANTIMICROBIAL EFFECT – 24-HOUR ELAPSED TIME

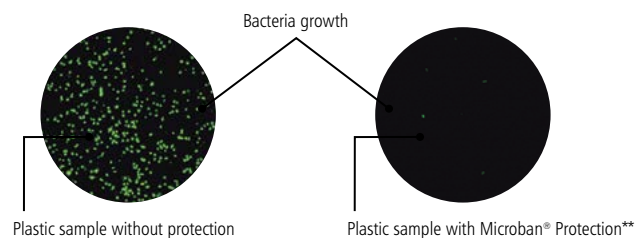

**This information is based upon standard laboratory tests and is provided for comparative purposes to substantiate antimicrobial activity for nonpublic health applications. Microban® technology is not designed to replace good building practices or protect users from disease-causing microorganisms. Antimicrobial action limited to product surfaces.



Common Metric–English Conversions

| Measurement | Multiply | By | To get: |
|-------------|--|--|---|
| Linear | centimeters (cm) inches (in. / ") meters (m) feet (ft. /') | 0.3937 2.54 3.2804 0.3048 | inches centimeters feet meters |
| Area | centimeters ² (cm ²) inches ² (in ²) meters ² (m ²) feet ² (ft ²) | 0.155 6.4516 10.76391 0.092903 | inches ² centimeters ² feet ² meters ² |
| Volume | centimeters ³ (cm ³) inches ³ milliliters fluid ounces liters gallons | 0.06102 16.387 0.033814 29.5735 0.26417 3.78541 | inches ³ centimeters ³ fluid ounces milliliters gallons liters |
| Mass | kilogram (kg) pounds (lbs.) grams (g) ounces (oz.) | 2.2046 0.4536 0.035274 28.3495 | pounds kilograms ounces grams |

| Metric Temperature Conversion To Get: | |
|---------------------------------------|--|
| Degrees Celsius (C°) | $\frac{5 \times (\text{degrees F} - 32)}{9}$ |
| Degrees Fahrenheit (F°) | $\frac{9 \times (\text{degrees C})}{5} + 32$ |

UTILITY AND
RECYCLING REFUSE















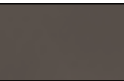



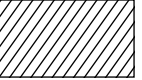

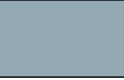

























DECORATIVE REFUSE

CLEANING

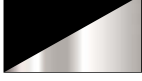
MATERIAL HANDLING

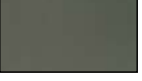
WASHROOM

FOODSERVICE

| | | | | | |
|---|---|---|--|---|---|
|  |  |  |  |  |  |
| Aged Bronze AGBRNZ | Antique Pewter ATPWTR | Beige BEIG | Black BLA/BK00/38 | Blue BLUE/BL00 | Bronze BRNZ |
|  |  |  |  |  |  |
| Brown BRN | Charcoal CHAR | Chrome CHRM | Clear CLR | Cobalt COBLT | Cool Gray CGRAY |
|  |  |  |  |  |  |
| Cylinder CYLND | Dark Blue DBLUE | Dark Green DGRN | Driftwood DWOOD | Gold GOLD | Gray GRAY/GY00/331 |
|  |  |  |  |  |  |
| Gray Metallic Burl BGRAY | Green GRN/GR00/714 | Hammered Silver HSILV | Lacquer LAC | Landmark Steel/ Brown BRN | Landmark Steel/ Brown/Brown BBRN |
|  |  |  |  |  |  |
| Landmark Steel/ Gray GRAY | Landmark Steel/ Green GRN | Light Gray LGRAY | Light Platinum LPLAT | Mirror Stainless MSSTL | Natural NAT |
|  |  |  |  |  |  |
| Natural (Foodservice) NAT | No Color 0000 | Off-White OWHT | Orange ORAN/OR00/11 | Periwinkle PERI | Platinum PLAT/907 |
|  |  |  |  |  |  |
| Red RED/RD00 | Sable SBLE | Sandstone SSTON | Satin Stainless SSSTL | Silver SILV | Stainless Steel SSSTL/SSS/SS |
|  |  |  |  |  |  |
| Stainless Steel/ Black Top SSBLA | Steel STL | Sterling Gray SGRAY | White WHT/WH00 | White Granite WGRAN | Yellow YEL/YL00 |

UTILITY AND
RECYCLING REFUSE

DECORATIVE REFUSE

CLEANING

MATERIAL HANDLING

WASHROOM

FOODSERVICE

| PART NO. | Color | DESCRIPTION | PAGE | UPC |
|----------|------------|---|------|--------------|
| 401477 | | AutoFlush® Tempus Valve Adapter | 213 | |
| 401096 | | AutoFlush® High Mount Adapter Kit | 213 | 763905010962 |
| 401165 | | AutoFlush® Crane Valve Adapter Kit | 213 | 86876212914 |
| 401239 | | AutoFlush® Teck Valve Adapter Kit | 213 | 86876212921 |
| 401972 | | AutoFlush® Coyne & Delany/ Crane Rex Adapter Kit | 213 | 86876212945 |
| 401973 | | AutoFlush® Canadian Adapter Kit (Crane, Teck, Tempus) | 213 | 86876212952 |
| 490071 | | OneShot® A/C Adapter | 193 | 86876205732 |
| 490099 | | OneShot® 6V Adapter (bayonet) | 193 | 86876213362 |
| 490100 | | OneShot® Adapter Wire (bayonet) | 193 | 86876205763 |
| 750577 | | Lock | 207 | |
| 1779636 | Blue | Lid for 44-Gallon BRUTE® Containers | 13 | 86876209112 |
| 1779699 | Blue | BRUTE® Container without Lid | 12 | 86876208979 |
| 1779700 | Blue | Lid for 10-Gallon BRUTE® Container | 13 | 86876208986 |
| 1779731 | Blue | Lid for 20-Gallon BRUTE® Container | 13 | 86876208993 |
| 1779732 | Blue | BRUTE® Container without Lid | 12 | 86876209006 |
| 1779733 | Blue | Lid for 55-Gallon BRUTE® Container | 13 | 86876209013 |
| 1779734 | Black | Executive BRUTE® Container without Lid | 12 | 86876209020 |
| 1779738 | Black | Executive Lid for 55-Gallon BRUTE® Container | 13 | 86876209068 |
| 1779739 | Black | BRUTE® Container without Lid | 12 | 86876209075 |
| 1779740 | White | BRUTE® Container without Lid | 12 | 86876209082 |
| 1779741 | Dark Green | BRUTE® Container without Lid | 12 | 86876209099 |
| 1779742 | Gray | Untouchable® Top for FG295600 Container | 39 | 86876209105 |
| 1782742 | | Milano in Polished Chrome | 211 | 86876210699 |
| 1782743 | | Milano in Polished Chrome (Low Lead) | 211 | 86876210705 |
| 1782744 | | Milano in Polished Chrome (Low Lead) | 211 | 86876210712 |
| 1784284 | | HYGEN™ Microfiber Kit with Charging Bucket | 87 | 86876211092 |
| 1788372 | Blue | Slim Jim® Mixed Recycling Lid for Slim Jim® Containers | 26 | |
| 1788373 | Green | Slim Jim® Recycling Mixed Lid Green | 26 | |
| 1788374 | Blue | Untouchable® Single-Stream Recycling Top for FG356988 Container | 37 | 86876211566 |
| 1788375 | Green | Untouchable® Single-Stream Recycling Top for FG356988 Container | 37 | 86876211573 |
| 1788380 | Blue | BRUTE® 32G Lid — Mixed Recycling | 13 | 86876211627 |
| 1788471 | Green | BRUTE® 32G Lid — Mixed Recycling | 13 | 86876211634 |
| 1788472 | Green | BRUTE® Recycling Container without Lid | 12 | 86876211641 |
| 1791678 | Gray | HYGEN™ General-Purpose Microfiber Mop | 84 | 86876212389 |
| 1791679 | Green/Blue | HYGEN™ Microfiber Wet and Dust Mop Plus for PULSE™ | 84 | 86876212396 |
| 1791680 | Blue | HYGEN™ Microfiber Mop Plus | 84 | 86876212402 |
| 1791796 | Blue | HYGEN™ Rough-Surface Scrub Microfiber Mop | 84 | 86876212464 |
| 1791802 | Yellow | HYGEN™ Charging Bucket with Sieve | 82 | 86876212532 |
| 1792339 | Blue | Two-Stream Glutton® Recycling Station | 41 | 86876212099 |
| 1792340 | Green | Two-Stream Glutton® Recycling Station | 41 | 86876212105 |

| PART NO. | Color | DESCRIPTION | PAGE | UPC |
|----------|--------|---|------|-------------|
| 1792371 | Beige | Two-Stream Glutton® Recycling Station | 41 | 86876212112 |
| 1792372 | Blue | Four-Stream Glutton® Recycling Station | 41 | 86876212129 |
| 1792373 | Green | Four-Stream Glutton® Recycling Station | 41 | 86876212136 |
| 1792374 | Beige | Four-Stream Glutton® Recycling Station | 41 | 86876212143 |
| 1792975 | | Waste Stream Label Kit | 41 | 86876212167 |
| 1793506 | White | AutoJanitor® LED Dispenser — White | 214 | 86876212662 |
| 1793507 | Chrome | AutoJanitor® LED Dispenser — Chrome | 214 | 86876212679 |
| 1793531 | Black | Microburst® 3000 LCD Dispenser — Black | 203 | 86876212716 |
| 1793532 | White | Microburst® 3000 LCD Dispenser — White | 203 | 86876212723 |
| 1793533 | Chrome | Microburst® 3000 LCD Dispenser — Chrome | 203 | 86876212730 |
| 1793534 | Black | Microburst® 9000 LCD Dispenser — Black | 204 | 86876212747 |
| 1793535 | White | Microburst® 9000 LCD Dispenser — White | 204 | 86876212754 |
| 1793536 | Chrome | Microburst® 9000 LCD Dispenser — Chrome | 204 | 86876212761 |
| 1793541 | White | Standard Aerosol LCD Dispenser — White | 206 | 86876212815 |
| 1793544 | White | TCell™ Fan Dispenser — White | 207 | 86876212846 |
| 1793546 | Black | TCell™ Dispenser — Black | 207 | 86876212860 |
| 1793547 | White | TCell™ Dispenser — White | 207 | 86876212877 |
| 1793548 | Chrome | TCell™ Dispenser — Chrome | 207 | 86876212884 |
| 1805727 | Red | Sanitizer-Safe Microfiber Cloth — Red | 87 | 86876213522 |
| 1805728 | Blue | Sanitizer-Safe Microfiber Cloth — Blue | 87 | 86876213539 |
| 1805730 | Green | Sanitizer-Safe Microfiber Cloth — Green | 87 | 86876213553 |
| 1809375 | | Self-Wringing Twist Mop | 117 | 41301001761 |
| 1812588 | | Compact Digital Portion Control Scale (2 lb) | 234 | 86876214130 |
| 1812589 | | Compact Digital Portion Control Scale (10 lb) | 234 | 86876214147 |
| 1812590 | | High-Performance Digital Portion Control Scale (2 lb) | 234 | 86876214154 |
| 1812591 | | High-Performance Digital Portion Control Scale (12 lb) | 234 | 86876214161 |
| 1812592 | | High-Performance Digital Portion Control Scale (24 lb) | 234 | 86876214178 |
| 1812595 | | Premium Stainless Steel Dishwasher-Safe Digital Portion Control Scale (12 lb) | 234 | 86876214208 |
| 1818966 | | Milano in Polished Chrome | 271 | 86876219197 |
| 1818967 | | Milano in Polished Chrome | 271 | 86876219203 |
| 1818968 | | Milano in Polished Chrome | 271 | 86876219210 |
| 1819679 | | Sturdy Chair™ Youth Seat, RTA (ready to assemble), No Wheels | 242 | |
| 1819680 | | Tray for FG780508, FG780608, and FG781408 Chai | 242 | |
| 1820577 | Pink | 12" x 12" Microfiber Light Commercial Cloth | 88 | 86876215182 |
| 1820578 | Green | 12" x 12" Microfiber Light Commercial Cloth | 88 | 86876215199 |
| 1820579 | Blue | 12" x 12" Microfiber Light Commercial Cloth | 88 | 86876215205 |
| 1820580 | Yellow | 12" x 12" Microfiber Light Commercial Cloth | 88 | 86876215212 |
| 1820581 | Pink | 16" x 16" Microfiber Light Commercial Cloth | 88 | 86876215229 |
| 1820582 | Green | 16" x 16" Microfiber Light Commercial Cloth | 88 | 86876215236 |
| 1820583 | Blue | 16" x 16" Microfiber Light Commercial Cloth | 88 | 86876215243 |

| PART NO. | Color | DESCRIPTION | PAGE | UPC |
|----------|---------------------------|---|------|-------------|
| 1820584 | Yellow | 16" x 16" Microfiber Light Commercial Cloth | 88 | 86876215250 |
| 1822351 | White | HYGEN™ Disposable Microfiber Cloth Charging Tub | 75 | 86876221138 |
| 1822352 | White | HYGEN™ Disposable Microfiber Mop Pad | 75 | 86876218398 |
| 1824723 | Red/Blue/ Yellow/Green | Sanitizer-Safe Microfiber Cloth – 4-Pack | 87 | 86876216318 |
| 1829398 | Blue | BRUTE® Dome Top for 32-Gallon BRUTE® Container | 13 | 86876215922 |
| 1829400 | Green | Slim Jim® Swing Lid for Slim Jim® Containers | 26 | |
| 1829407 | Blue | Untouchable® Swing Top for FG295700 Container | 39 | 86876216028 |
| 1829409 | Gray | Untouchable® Swing Top for FG295700 Container | 39 | 86876216042 |
| 1829410 | White | BRUTE® Rollout Container with Lid | 17 | 86876216059 |
| 1829411 | Green | BRUTE® Rollout Container with Lid | 17 | 86876216066 |
| 1834781 | Red | Round Bucket – Sanitizer | 116 | 86876216455 |
| 1834840 | Blue | BRUTE® Dome Top for 44-Gallon BRUTE® Container | 13 | 86876216424 |
| 1835528 | Yellow | HYGEN™ PULSE™ Mopping Kit with Single-Sided Frame | 82 | 86876192339 |
| 1835529 | Yellow | HYGEN™ PULSE™ Mopping Kit with Double-Sided Folding Frame | 84 | 86876212372 |
| 1837785 | Black | Executive Housekeeping Cart Waste/Bag Lid – Traditional | 144 | 86876217186 |
| 1837941 | | Key | 207 | |
| 1840999 | Orange | Insulated Beverage Dispenser | 305 | 79154116219 |
| 1842436 | Clear | Cold Pan | 231 | 86876218282 |
| 1842437 | Clear | Cold Pan | 231 | 86876218299 |
| 1853755 | Chrome | Foam Skin Care Dispenser 800 mL – Chrome | 198 | 86876227277 |
| 1857374 | Yellow | 5-Quart Pail – Yellow | 140 | 86876219432 |
| 1857375 | Red | 5-Quart Pail – Red | 140 | 86876219449 |
| 1857376 | Blue | 5-Quart Pail – Blue | 140 | 86876219456 |
| 1857377 | Green | 5-Quart Pail – Green | 140 | 86876219463 |
| 1857378 | Black | Executive 5-Quart Heavy-Duty Pail – Black | 140 | 86876219470 |
| 1861076 | Black | Executive Angle Broom w/ Vinyl Handle | 129 | 86876220650 |
| 1861078 | Black | Executive Angle Broom w/ Aluminum Handle | 129 | 86876220667 |
| 1861427 | Black | Executive Janitorial Cleaning Cart, High-Security | 179 | 86876221251 |
| 1861427 | Black | Executive Janitorial Cleaning Cart – High-Security | 138 | 86876221251 |
| 1861430 | Black | Executive Janitorial Cleaning Cart – Traditional | 139 | 86876221282 |
| 1861443 | Black | Executive Janitorial Cleaning Cart Locking Door Kit – Traditional | 139 | 86876221312 |
| 1861443 | Black | Executive Janitorial Cleaning Cart Locking Door Kit – Traditional, Black | 140 | 86876221312 |
| 1863882 | Silver | Executive HYGEN™ 42" to 72" (121.9 cm– 182.9 cm) Microfiber Telescoping Handle | 81 | 86876220483 |
| 1863883 | Silver | Executive HYGEN™ 20" to 40" (50.8 cm– 101.6 cm) Microfiber Telescoping Handle | 81 | 86876220490 |
| 1863884 | Silver | Executive HYGEN™ PULSE™ Microfiber Spray Mop, Single-Sided Flat Mop | 83 | 86876220506 |
| 1863885 | Silver | Executive HYGEN™ PULSE™ Microfiber Spray Mop, Double-Sided Flat Mop | 85 | 86876220513 |
| 1863888 | Gray | Executive 12" Multipurpose Microfiber Cloth | 88 | 86876220544 |
| 1863889 | Gray | Executive 16" Multipurpose Microfiber Towel | 88 | 86876220551 |

| PART NO. | Color | DESCRIPTION | PAGE | UPC |
|----------|-----------|--|------|---------------|
| 1863892 | Gray | Executive HYGEN™ Microfiber Charging Mop Bucket | 82 | 86876220582 |
| 1863893 | Black | Executive 17" (43.2 cm) HYGEN™ Quick-Connect Wet/Dry Frame | 80 | 86876220599 |
| 1863894 | Black | Executive 18" HYGEN™ PULSE™ Microfiber Flat Mop Frame, Double-Sided | 85 | 86876220605 |
| 1863895 | Gray | Executive Series™ HYGEN™ 18" Microfiber Wet Pad | 79 | 86876220612 |
| 1863896 | Black | 35 qt WaveBrake® Side-Press Bucket and Wringer, Executive Series™ | 95 | 86876221152 |
| 1863898 | Black | Executive WaveBrake® Down-Press Combo | 137 | 86876221176 |
| 1863901 | Black | Executive 60" Fiberglass Mop Handle and Gripper® Clamp Frame – String Mop | 115 | 86876221220 |
| 1863903 | Black | Executive 60" Fiberglass Mop Handle and Invader® Side-Gate Frame – String Mop | 115 | 86876221213 |
| 1867396 | Black | Executive 1" HYGEN™ Microfiber Flexible Flat Mop Frame, Single-Sided | 77 | 86876220629 |
| 1867397 | Gray | Executive HYGEN™ Multipurpose Microfiber PULSE™ Dust Flat Mop, Single-Sided | 78 | 86876220636 |
| 1867398 | Gray | Executive 16" HYGEN™ Glass Microfiber Cloth (Gray) | 76 | 86876220643 |
| 1867505 | Black | Executive Multilingual Caution Sign, 2-Sided, Black | 155 | 86876222180 |
| 1867506 | Gray | Executive Multilingual Caution Sign, 2-Sided, Gray | 155 | 86876222197 |
| 1867507 | Gold | Executive Wooden Multilingual Caution Sign, 2-Sided, Gold | 155 | 86876222203 |
| 1867508 | Silver | Executive Wooden Multilingual Caution Sign, 2-Sided, Silver | 155 | 86876222210 |
| 1867509 | Black | Executive Multilingual Caution Sign, 4-Sided, Black | 155 | 86876222227 |
| 1867531 | Black | Executive BRUTE® Container without Lid | 12 | 86876222241 |
| 1867531 | Black | Executive BRUTE® 32-Gallon Container | 141 | 86876222241 |
| 1867532 | Black | Executive Lid for 32-Gallon BRUTE® Container | 13 | 86876222258 |
| 1867533 | Black | Executive BRUTE® Caddy Bag for 32- and 44-Gallon BRUTE® Containers | 15 | 86876222265 |
| 1867537 | Black | Executive Cube Truck w/ Quiet Casters | 168 | 86876222296 |
| 1867538 | Black | Executive Cube Truck w/ Quiet Casters | 168 | 86876222302 |
| 1868991 | Black | Executive Cart Waste/Bag Lid – High-Capacity | 141 | 7892279089915 |
| 1878365 | | Executive 6" Quiet Caster Wheel Kit, Housekeeping Carts | 141 | 86876221374 |
| 1878367 | Dark Gray | Executive Quiet Caster and Ball-Bearing Wheel Kit | 141 | 86876221343 |
| 1878368 | | Vacuum Bungees for Carts | 140 | 86876221350 |
| 1880994 | Black | Executive Divided Carry Caddy | 144 | 86876222166 |
| 1880994 | Black | Executive Divided Carry Caddy | 149 | 86876222166 |
| 1880995 | Gray | Executive Divided Carry Caddy | 144 | 86876222173 |
| 1880995 | Gray | Executive Divided Carry Caddy | 149 | 86876222173 |
| 1881749 | Black | Collapsible X-Cart, 4 Bushels | 169 | 86876221626 |
| 1881750 | Black | Collapsible X-Cart, 8 Bushels | 169 | 86876221633 |
| 1881781 | Black | Collapsible Multi-Stream X-Cart (2 x 4 Bushels) | 169 | 86876221640 |

UTILITY AND
RECYCLING REFUSE

DECORATIVE REFUSE

CLEANING

MATERIAL HANDLING

WASHROOM

FOODSERVICE

ACCESSORIES
& INDEX



| PART NO. | Color | DESCRIPTION | PAGE | UPC |
|----------|-------|---|------|-------------|
| 1881782 | Black | Collapsible X-Cart Replacement Bag – 4 Bushels | 169 | 86876221657 |
| 1881783 | Black | Collapsible X-Cart Replacement Bag – 8 Bushels | 169 | 86876221664 |
| 1883455 | Beige | Resin Front Step | 35 | 86876223897 |
| 1883456 | Beige | Resin Front Step | 35 | 86876223903 |
| 1883457 | Beige | Resin End Step | 35 | 86876223910 |
| 1883458 | Beige | Resin Front Step | 35 | 86876223927 |
| 1883459 | Beige | Resin End Step | 35 | 86876223934 |
| 1883460 | Beige | Resin Front Step | 35 | 86876223941 |
| 1883551 | Beige | Resin End Step | 35 | 86876223958 |
| 1883552 | Beige | Resin Front Step | 35 | 86876223965 |
| 1883553 | Beige | Resin End Step | 35 | 86876223972 |
| 1883554 | White | Resin Front Step | 35 | 86876223989 |
| 1883555 | White | Resin Front Step | 35 | 86876223996 |
| 1883557 | White | Resin Front Step | 35 | 86876224016 |
| 1883559 | White | Resin Front Step | 35 | 86876224030 |
| 1883561 | White | Resin Front Step | 35 | 86876224054 |
| 1883563 | Red | Resin Front Step | 35 | 86876224078 |
| 1883564 | Red | Resin Front Step | 35 | 86876224085 |
| 1883565 | Red | Resin End Step | 35 | 86876224092 |
| 1883566 | Red | Resin Front Step | 35 | 86876224108 |
| 1883568 | Red | Resin Front Step | 35 | 86876224122 |
| 1883570 | Red | Resin Front Step | 35 | 86876224146 |
| 1883593 | Blue | Resin Front Step | 35 | 86876224375 |
| 1883597 | Blue | Resin Front Step | 35 | 86876224412 |
| 1883599 | Gray | Resin Front Step | 35 | 86876224436 |
| 1883600 | Gray | Resin Front Step | 35 | 86876224443 |
| 1883602 | Gray | Resin Front Step | 35 | 86876224467 |
| 1883604 | Gray | Resin Front Step | 35 | 86876224481 |
| 1883606 | Gray | Resin Front Step | 35 | 86876224504 |
| 1883608 | Black | Resin Front Step | 35 | 86876224528 |
| 1883609 | Black | Resin Front Step | 35 | 86876224535 |
| 1883610 | Black | Resin End Step | 35 | 86876224542 |
| 1883611 | Black | Resin Front Step | 35 | 86876224559 |
| 1883612 | Black | Resin End Step | 35 | 86876224566 |
| 1883613 | Black | Resin Front Step | 35 | 86876224573 |
| 1883614 | Black | Resin End Step | 35 | 86876224580 |
| 1883615 | Black | Resin Front Step | 35 | 86876224597 |
| 1883616 | Black | Resin End Step | 35 | 86876224603 |
| 1883617 | | Slim Jim® Rigid Liner for 50L/13G Resin FS | 36 | 86876224856 |
| 1883618 | | Slim Jim® Rigid Liner for 30L/8G Resin FS | 36 | 86876224863 |
| 1883619 | | Slim Jim® Rigid Liner for 50L/13G Resin FS | 36 | 86876224870 |
| 1883620 | | Slim Jim® Rigid Liner for 68L/18G Resin FS | 36 | 86876224887 |
| 1883621 | | Slim Jim® Rigid Liner for 90L/24G Resin FS | 36 | 86876224894 |
| 1883623 | | Slim Jim® Rigid Liner for 30L/8G Resin ES | 36 | 86876224900 |
| 1883624 | | Slim Jim® Rigid Liner for 50L/13G Resin ES | 36 | 86876224917 |
| 1883625 | | Slim Jim® Rigid Liner for 68L/18G Resin ES | 36 | 86876224924 |
| 1883626 | | Slim Jim® Rigid Liner for 90L/24G Resin ES | 36 | 86876224931 |
| 1883629 | | Dual Liner for Slim Jim® 90L/24G Resin FS | 36 | 86876224962 |
| 1889863 | Black | Collapsible X-Cart Cover, Small (for 1881749) | 169 | 86876223019 |
| 1889864 | Black | Collapsible X-Cart Cover, Large (for 1881750 and 1881781) | 169 | 86876223026 |
| 1892265 | | AutoFoam Drip Tray | 195 | |
| 1900666 | | For 15L/4G Stainless Steel FS | 59 | 86876225105 |
| 1900669 | | Rigid Liner Set For Slim Jim® 15L/4G Stainless Steel FS | 59 | 86876225037 |
| 1900680 | | Rigid Liner Set For Slim Jim® 30L/8G Stainless Steel ES | 59 | 86876225051 |

| PART NO. | Color | DESCRIPTION | PAGE | UPC |
|----------|-----------------|---|------|-------------|
| 1900696 | | Rigid Liner Set For 30L/8G Stainless Steel FS | 59 | 86876225129 |
| 1900697 | | Rigid Liner Set For Slim Jim® 30L/8G Stainless Steel FS | 59 | 86876225044 |
| 1900713 | | Rigid Liner Set For 50L/13G Stainless Steel FS | 59 | 86876225136 |
| 1900715 | | Rigid Liner Set For Slim Jim® 50L/13G Stainless Steel FS | 59 | 86876225068 |
| 1900733 | | Rigid Liner For 90L/24G Stainless Steel FS | 59 | 86876226454 |
| 1900734 | | For Slim Jim® 90L/24G Stainless Steel FS | 59 | 86876225082 |
| 1900895 | | For 50L/13G Stainless Steel ES | 59 | 86876225143 |
| 1900896 | | For Slim Jim® 50L/13G Stainless Steel ES | 59 | 86876225075 |
| 1900912 | | For 90L/24G Stainless Steel ES | 59 | 86876225150 |
| 1900913 | | Rigid Liner For Slim Jim® 90L/24G Stainless Steel ES | 59 | 86876225099 |
| 1901982 | Stainless Steel | Stainless Steel Front Step | 55 | 86876224610 |
| 1901985 | Stainless Steel | Stainless Steel Front Step | 55 | 86876224627 |
| 1901987 | Stainless Steel | Stainless Steel Front Step with Dual Liner | 55 | 86876224634 |
| 1901992 | Stainless Steel | Stainless Steel Front Step | 55 | 86876224658 |
| 1901993 | Stainless Steel | Stainless Steel End Step | 55 | 86876224672 |
| 1901994 | Stainless Steel | Stainless Steel Front Step with Dual Liner | 55 | 86876224665 |
| 1901999 | Stainless Steel | Stainless Steel Front Step | 55 | 86876224689 |
| 1902000 | Stainless Steel | Stainless Steel End Step | 55 | 86876224702 |
| 1902001 | Stainless Steel | Stainless Steel Front Step with Dual Liner | 55 | 86876224696 |
| 1902006 | | Dual Liner Sets For Slim Jim® 30L/8G Stainless Steel FS | 59 | 86876224979 |
| 1902008 | | Dual Liner Sets For Slim Jim® 50L/13G Stainless Steel FS | 59 | 86876224986 |
| 1902010 | | For Slim Jim® 90L/24G Stainless Steel FS | 59 | 86876224993 |
| 1902459 | Dark Gray | Executive Quick Cart Caddy – Small | 146 | 86876223712 |
| 1902465 | Dark Gray | Executive Quick Cart – Large | 146 | 86876223583 |
| 1902466 | Dark Gray | Executive Quick Cart – Medium | 146 | 86876223590 |
| 1902467 | Dark Gray | Executive Quick Cart – Small | 146 | 86876223606 |
| 1902468 | Dark Gray | Executive Quick Cart Caddy – Large | 146 | 86876223705 |
| 1902701 | Black | Executive Quick Cart Liner – Large | 146 | 86876223767 |
| 1902702 | Black | Executive Quick Cart Liner – Medium | 146 | 86876223774 |
| 1902703 | Black | Executive Quick Cart Liner – Small | 146 | 86876223781 |
| 1903281 | | Verona in Polished Chrome | 211 | 86876222845 |
| 1903286 | | Milano in Polished Chrome | 211 | 86876222722 |
| 1903287 | | Milano in Polished Chrome | 211 | 86876222739 |
| 1903288 | | Milano in Polished Chrome | 211 | 86876222746 |
| 1903289 | | Milano in Polished Chrome | 211 | 86876222753 |
| 1903290 | | Milano in Polished Chrome | 211 | 86876222760 |
| 1903291 | | Milano in Polished Chrome | 211 | 86876222777 |
| 1919270 | Clear | Executive Quick Cart Plastic Pocket Liner | 146 | 86876223798 |
| 1924782 | Blue | Maximizer™ Blend Mop | 102 | |
| 1924783 | Blue | Maximizer™ Blend Mop | 102 | |
| 1924786 | Red | Maximizer™ Blend Mop | 102 | |
| 1924787 | Red | Maximizer™ Blend Mop | 102 | |
| 1924812 | Blue | Maximizer™ Microfiber Mop | 102 | 86876225679 |
| 1924813 | Blue | Maximizer™ Microfiber Mop | 102 | 86876225686 |
| 1924814 | Green | Maximizer™ Microfiber Mop | 102 | 86876225693 |
| 1924815 | Green | Maximizer™ Microfiber Mop | 102 | 86876225709 |
| 1924816 | Red | Maximizer™ Microfiber Mop | 102 | 86876225716 |
| 1924817 | Red | Maximizer™ Microfiber Mop | 102 | 86876225723 |
| 1925447 | | Damper Replacement for 30L/8G, 50L/13G, 68L/18G, & 90L/24G Resin FS | 36 | 86876225372 |

| PART NO. | Color | DESCRIPTION | PAGE | UPC |
|----------|-----------------|--|------|-------------|
| 1925497 | | Damper Replacement for 30L/8G & 50L/13G ES Resin | 36 | 86876225358 |
| 1925498 | | Damper Replacement for 68L/18G & 90 L/24G ES Resin | 36 | 86876225365 |
| 1926826 | Black | Lid for 10-Gallon BRUTE® Container | 13 | 86876225389 |
| 1926827 | Black | BRUTE® Container without Lid | 12 | 86876225396 |
| 1926828 | Dark Green | BRUTE® Recycling Container without Lid | 12 | 86876225402 |
| 1926829 | Dark Green | BRUTE® Recycling Container without Lid | 12 | 86876225419 |
| 1928023 | White | HYGEN™ Disposable Microfiber Cloth Refill Pack | 75 | 86876225747 |
| 1928024 | White | HYGEN™ Disposable Microfiber Cloth Bulk Pack | 75 | 86876225754 |
| 1928756 | White | HYGEN™ Disposable Microfiber Cloth Starter Kit | 75 | 86876225730 |
| 1937648 | Grey | Premier Small-Capacity Storage w/ Lid | 291 | 71691491514 |
| 1937691 | Grey | Premier Small-Capacity Storage w/ Lid | 291 | 71691490999 |
| 1937692 | Grey | Premier Small-Capacity Storage w/ Lid | 291 | 71691490968 |
| 1937693 | Grey | Premier Small-Capacity Storage w/ Lid | 291 | 71691490975 |
| 1938171 | Polished Chrome | OneShot® Foam Dispenser Low Profile | 193 | |
| 1951293 | Grey | Premier Small-Capacity Storage w/ Lid | 291 | 71691494928 |
| 1955228 | Black | Microburst® 3000 Dispenser with LumeCel™ Technology — Black | 202 | 86876227062 |
| 1955229 | White | Microburst® 3000 Dispenser with LumeCel™ Technology — White | 202 | 86876227079 |
| 1955230 | Chrome | Microburst® 3000 Dispenser with LumeCel™ Technology — Chrome | 202 | 86876227086 |
| 1955959 | Black | Slim Jim® Container with Venting Channels | 22 | 86876227840 |
| 1955960 | Green | Slim Jim® Container with Venting Channels | 22 | 86876227857 |
| 1956181 | Brown | Slim Jim® Container with Venting Channels | 22 | 86876227864 |
| 1956185 | Blue | Slim Jim® Container with Venting Channels | 22 | 86876227956 |
| 1956186 | Green | Slim Jim® Container with Venting Channels | 22 | 86876227925 |
| 1956187 | Brown | Slim Jim® Container with Venting Channels | 22 | 86876227932 |
| 1956188 | Yellow | Slim Jim® Container with Venting Channels | 22 | 86876227963 |
| 1956189 | Red | Slim Jim® Container with Venting Channels | 22 | 86876227949 |
| 1956191 | Stainless | Slim Jim® Stainless Steel Dolly for Slim Jim® Containers – Double | 23 | 86876227987 |
| 1956191 | Stainless | Slim Jim® Stainless Steel Dolly for Slim Jim® Containers – Double | 33 | 86876227987 |
| 1956192 | Stainless | Slim Jim® Stainless Steel Dolly for Slim Jim® Containers – Triple | 23 | 86876227994 |
| 1956192 | Stainless | Slim Jim® Stainless Steel Dolly for Slim Jim® Containers – Triple | 33 | 86876227994 |
| 1956193 | Stainless | Slim Jim® Stainless Steel Dolly for Slim Jim® Containers – Quadruple | 23 | 86876228007 |
| 1956193 | Stainless | Slim Jim® Stainless Steel Dolly for Slim Jim® Containers – Quadruple | 33 | 86876228007 |
| 1957521 | | TCell™ 2.0 Refill — Spring Blossoms | 265 | 86876227741 |
| 1957522 | | TCell™ 2.0 Refill — Citrus Zest | 265 | 86876227734 |

| PART NO. | Color | DESCRIPTION | PAGE | UPC |
|----------|-------------------|------------------------------------|------|-------------|
| 1957523 | | TCell™ 2.0 Refill — Mango Blast | 265 | 86876227758 |
| 1957524 | | TCell™ 2.0 Refill — Cucumber Melon | 265 | 86876227765 |
| 1957525 | | TCell™ 2.0 Refill — Marine Fresh | 265 | 86876227772 |
| 1957526 | | TCell™ 2.0 Refill — Lavender Mint | 265 | 86876227789 |
| 1957527 | | TCell™ 2.0 Refill — Opulence | 265 | 86876227796 |
| 1957528 | | TCell™ 2.0 Refill — Decadence | 265 | 86876227802 |
| 1957529 | | TCell™ 2.0 Refill — Elegance | 265 | 86876227819 |
| 1957531 | Black | TCell™ 2.0 Dispenser — Black | 265 | 86876227673 |
| 1957531 | Black | TCell™ 2.0 Dispenser — Black | 265 | 86876227673 |
| 1957532 | White | TCell™ 2.0 Dispenser — White | 265 | 86876227680 |
| 1957532 | White | TCell™ 2.0 Dispenser — White | 265 | 86876227680 |
| 1957533 | Chrome | TCell™ 2.0 Dispenser — Chrome | 265 | 86876227697 |
| 1957533 | Chrome | TCell™ 2.0 Dispenser — Chrome | 265 | 86876227697 |
| 1961505 | Grey Stenni Gloss | 33G with Cans Label | 48 | 86876228670 |
| 1961506 | Grey Stenni Gloss | 33G with Organic Label | 48 | 86876228687 |
| 1961507 | Grey Stenni Gloss | 45G with Landfill Label | 48 | 86876228694 |
| 1961508 | Grey Stenni Gloss | 45G with Mixed Label | 48 | 86876228700 |
| 1961509 | Grey Stenni Gloss | 45G with Paper Label | 48 | 86876228717 |
| 1961510 | Grey Stenni Gloss | 45G with Plastic Label | 48 | 86876228724 |
| 1961572 | Black | Landfill Black Sign | 49 | |
| 1961573 | Black | Landfill Black Sign | 49 | |
| 1961574 | Black | Landfill Black Sign | 49 | |
| 1961575 | Black | Landfill Black Sign | 49 | |
| 1961576 | Orange | Glass Orange Sign | 49 | |
| 1961577 | Orange | Glass Orange Sign | 49 | |
| 1961578 | Orange | Glass Orange Sign | 49 | |
| 1961579 | Orange | Glass Orange Sign | 49 | |
| 1961580 | Green | Organic Waste Green Sign | 49 | |
| 1961581 | Green | Organic Waste Green Sign | 49 | |
| 1961582 | Green | Organic Waste Green Sign | 49 | |
| 1961583 | Green | Organic Waste Green Sign | 49 | |
| 1961584 | Red | Plastic Red Sign | 49 | |
| 1961585 | Red | Plastic Red Sign | 49 | |
| 1961586 | Red | Plastic Red Sign | 49 | |
| 1961587 | Red | Plastic Red Sign | 49 | |
| 1961588 | Blue | Mixed Recycling Blue Sign | 49 | |
| 1961589 | Blue | Paper Blue Sign | 49 | |
| 1961590 | Blue | Mixed Recycling Blue Sign | 49 | |
| 1961591 | Blue | Paper Blue Sign | 49 | |
| 1961592 | Blue | Mixed Recycling Blue Sign | 49 | |
| 1961593 | Blue | Paper Blue Sign | 49 | |
| 1961594 | Blue | Mixed Recycling Blue Sign | 49 | |
| 1961595 | Blue | Paper Blue Sign | 49 | |
| 1961596 | Yellow | Cans Yellow Sign | 49 | |
| 1961597 | Yellow | Cans Yellow Sign | 49 | |
| 1961598 | Yellow | Cans Yellow Sign | 49 | |
| 1961599 | Yellow | Cans Yellow Sign | 49 | |
| 1961614 | Grey Stenni Gloss | 15G with Landfill Label | 48 | 86876228489 |
| 1961615 | Grey Stenni Gloss | 15G with Mixed Label | 48 | 86876228496 |
| 1961616 | Grey Stenni Gloss | 15G with Paper Label | 48 | 86876228502 |
| 1961617 | Grey Stenni Gloss | 15G with Plastic Label | 48 | 86876228519 |
| 1961618 | Grey Stenni Gloss | 15G with Glass Label | 48 | 86876228526 |

UTILITY AND RECYCLING REFUSE

DECORATIVE REFUSE

CLEANING

MATERIAL HANDLING

WASHROOM

FOODSERVICE

ACCESSORIES & INDEX



| PART NO. | Color | DESCRIPTION | PAGE | UPC |
|----------|-------------------|---|------|-------------|
| 1961619 | Grey Stenni Gloss | 15G with Cans Label | 48 | 86876228533 |
| 1961620 | Grey Stenni Gloss | 15G with Organic Label | 48 | 86876228540 |
| 1961621 | Grey Stenni Gloss | 23G with Landfill Label | 48 | 86876228557 |
| 1961622 | Grey Stenni Gloss | 23G with Mixed Label | 48 | 86876228564 |
| 1961623 | Grey Stenni Gloss | 23G with Paper Label | 48 | 86876228571 |
| 1961624 | Grey Stenni Gloss | 23G with Plastic Label | 48 | 86876228588 |
| 1961625 | Grey Stenni Gloss | 23G with Glass Label | 48 | 86876228595 |
| 1961626 | Grey Stenni Gloss | 23G with Cans Label | 48 | 86876228601 |
| 1961627 | Grey Stenni Gloss | 23G with Organic Label | 48 | 86876228681 |
| 1961628 | Grey Stenni Gloss | 33G with Landfill Label | 48 | 86876228625 |
| 1961629 | Grey Stenni Gloss | 33G with Mixed Label | 48 | 86876228632 |
| 1961630 | Grey Stenni Gloss | 33G with Paper Label | 48 | 86876228649 |
| 1961641 | Grey Stenni Gloss | 33G with Plastic Label | 48 | 86876228656 |
| 1961642 | Grey Stenni Gloss | 33G with Glass Label | 48 | 86876228663 |
| 1961681 | Grey Stenni Gloss | 45G with Glass Label | 48 | 86876228731 |
| 1961682 | Grey Stenni Gloss | 45G with Cans Label | 48 | 86876228748 |
| 1961683 | Grey Stenni Gloss | 45G with Organic Label | 48 | 86876228755 |
| 1966719 | Yellow | 24-Gal. Janitorial Cleaning Cart Vinyl Bag – Traditional | 139 | 86876227338 |
| 1966720 | Black | Executive 24-Gal. Janitorial Cleaning Cart Vinyl Bag – Traditional | 139 | 86876227345 |
| 1966881 | Yellow | 34-Gal. Janitorial Cleaning Cart Vinyl Bag – High-Capacity | 184 | 86876227352 |
| 1966881 | Yellow | 34-Gal. Janitorial Cleaning Cart Vinyl Bag – High Capacity | 140 | 86876227352 |
| 1966882 | Red | 34-Gal. Janitorial Cleaning Cart Vinyl Bag – High-Capacity | 184 | 86876227369 |
| 1966882 | Red | 34-Gal. Janitorial Cleaning Cart Vinyl Bag – High-Capacity | 140 | 86876227369 |
| 1966883 | Blue | 34-Gal. Janitorial Cleaning Cart Vinyl Bag – High-Capacity | 184 | 86876227376 |
| 1966883 | Blue | 34-Gal. Janitorial Cleaning Cart Vinyl Bag – High-Capacity | 140 | 86876227376 |
| 1966884 | Green | 34-Gal. Janitorial Cleaning Cart Vinyl Bag – High-Capacity | 184 | 86876227383 |
| 1966884 | Green | 34-Gal. Janitorial Cleaning Cart Vinyl Bag – High-Capacity | 140 | 86876227383 |
| 1966885 | Brown | 34-Gal. Janitorial Cleaning Cart Vinyl Bag – High-Capacity | 140 | 86876227390 |
| 1966886 | Black | Executive 34-Gal. Janitorial Cleaning Cart Vinyl Bag – High-Capacity | 144 | 86876227406 |
| 1966886 | Black | Executive 34-Gal. Janitorial Cleaning Cart Vinyl Bag – High-Capacity | 142 | 86876227406 |
| 1966886 | Black | Executive 34-Gal. Janitorial Cleaning Cart Vinyl Bag – High-Capacity | 179 | 86876227406 |
| 1966887 | Brown | 30-Gal. Housekeeping Cart Canvas Vinyl-Lined Bag – High-Capacity | 144 | 86876227413 |
| 1966888 | Black | Executive 30-Gal. Housekeeping Cart Canvas Vinyl Lined Bag - High Capacity | 184 | 86876227420 |

| PART NO. | Color | DESCRIPTION | PAGE | UPC |
|----------|----------------|---|------|-------------|
| 1966888 | Black | Executive 30-Gal. Housekeeping Cart Canvas Vinyl-Lined Bag – High-Capacity | 144 | 86876227420 |
| 1966888 | Black | Executive 30-Gal. Housekeeping Cart Canvas Vinyl-Lined Bag – High Capacity | 142 | 86876227420 |
| 1966889 | Black | Executive Side-Load Mesh Linen Bag | 142 | 86876227437 |
| 1966889 | Black | Executive Side-Load Mesh Linen Bag | 144 | 86876227437 |
| 1967263 | | TCell™ 2.0 Refill — Pure | 265 | 86876227826 |
| 1968468 | Stainless | Slim Jim® Stainless Steel Dolly for Slim Jim® Containers – Single | 23 | 86876227970 |
| 1969596 | Platinum | Executive Full-Size Housekeeping Cart – Traditional | 142 | 86876227574 |
| 1971257 | Blue | Slim Jim® Container with Venting Channels | 22 | 86876227901 |
| 1971258 | Gray | Slim Jim® Container with Venting Channels | 22 | 86876227895 |
| 1971259 | Beige | Slim Jim® Container with Venting Channels | 22 | 86876227918 |
| 1971941 | Gray | BRUTE® Rollout | 17 | |
| 1971943 | Blue | BRUTE® Rollout | 17 | |
| 1971944 | Gray | BRUTE® Step-On Rollout | 17 | |
| 1971946 | Blue | BRUTE® Step-On Rollout | 17 | |
| 1971956 | Gray | BRUTE® Step-On Rollout | 17 | |
| 1971958 | Blue | BRUTE® Step-On Rollout | 17 | |
| 1971968 | Gray | BRUTE® Step-On Rollout | 17 | |
| 1971970 | Blue | BRUTE® Step-On Rollout | 17 | |
| 1971991 | Gray | BRUTE® Step-On Rollout | 17 | |
| 1971993 | Blue | BRUTE® Step-On Rollout | 17 | |
| 1971947 | Gray | BRUTE® Rollout With Casters | 18 | |
| 1971949 | Blue | BRUTE® Rollout With Casters | 18 | |
| 1971959 | Gray | BRUTE® Rollout With Casters | 18 | |
| 1971961 | Blue | BRUTE® Rollout With Casters | 18 | |
| 1971971 | Gray | BRUTE® Rollout With Casters | 18 | |
| 1971973 | Blue | BRUTE® Rollout With Casters | 18 | |
| 1971994 | Gray | BRUTE® Rollout With Casters | 18 | |
| 1971996 | Blue | BRUTE® Rollout With Casters | 18 | |
| 1972664 | Brushed Chrome | TCell™ 2.0 Dispenser — Brushed Chrome | 265 | 86876227703 |
| 1972664 | Brushed Chrome | TCell™ 2.0 Dispenser — Brushed Chrome | 265 | 86876227703 |
| 1971977 | Red | BRUTE® Medical Waste Rollout With Casters | 19 | |
| 1972000 | Red | BRUTE® Medical Waste Rollout With Casters | 19 | |
| 1975229 | | Executive 8" Quiet Caster – Swivel Fixed Pack 2 | 144 | 86876230215 |
| 1975230 | | Executive 8" Quiet Caster – Fixed Pack 2 | 144 | 86876230222 |
| 1977785 | | Waste Stream Label Kit Version A fits 20-Gallon BRUTE® Containers, 23- and 35-Gallon Untouchable® Containers, and Medium and Large Wastebaskets | 45 | |
| 1977787 | | Recycling Label Kit Version C fits 32- and 44-Gallon BRUTE® Containers | 45 | |
| 1977788 | | Waste Stream Label Kit Version D fits 50-Gallon BRUTE® Rollout Containers and 1/2- and 1-Cubic-Yard Tilt Trucks | 45 | |
| 1977789 | | Recycling Label Kit Version E fits 16- and 23-Gallon Slim Jim® Containers | 45 | |
| 1977789 | | Waste Stream Label Kit Version E fits 16- and 23-Gallon Slim Jim® Containers | 45 | |

| PART NO. | Color | DESCRIPTION | PAGE | UPC |
|----------|-------------------|--|------|-------------|
| 1978082 | Clear | Economy Pitcher | 305 | 71691501411 |
| 1980200 | Red | Color-Coded Square Container Lid | 228 | 86876231991 |
| 1980257 | Purple | Color-Coded Round Container Lid | 229 | 86876232363 |
| 1980260 | Red | Color-Coded Round Container Lid | 229 | 86876232394 |
| 1980301 | Green | Color-Coded Square Container Lid | 228 | 86876232004 |
| 1980302 | Blue | Color-Coded Square Container Lid | 228 | 86876232011 |
| 1980303 | Yellow | Color-Coded Square Container Lid | 228 | 86876232028 |
| 1980304 | Purple | Color-Coded Square Container Lid | 228 | 86876232035 |
| 1980307 | Red | Color-Coded Square Container Lid | 228 | 86876232059 |
| 1980308 | Green | Color-Coded Square Container Lid | 228 | 86876232066 |
| 1980309 | Blue | Color-Coded Square Container Lid | 228 | 86876232073 |
| 1980310 | Yellow | Color-Coded Square Container Lid | 228 | 86876232080 |
| 1980311 | Purple | Color-Coded Square Container Lid | 228 | 86876232097 |
| 1980337 | Red | Color-Coded Round Container Lid | 229 | 86876232332 |
| 1980338 | Green | Color-Coded Round Container Lid | 229 | 86876232349 |
| 1980339 | Blue | Color-Coded Round Container Lid | 229 | 86876232356 |
| 1980381 | Green | Color-Coded Round Container Lid | 229 | 86876232400 |
| 1980382 | Blue | Color-Coded Round Container Lid | 229 | 86876232417 |
| 1980384 | Purple | Color-Coded Round Container Lid | 229 | 86876232424 |
| 1980387 | Red | Color-Coded Round Container Lid | 229 | 86876232455 |
| 1980388 | Green | Color-Coded Round Container Lid | 229 | 86876232462 |
| 1980389 | Blue | Color-Coded Round Container Lid | 229 | 86876232479 |
| 1980391 | Purple | Color-Coded Round Container Lid | 229 | 86876232486 |
| 1980417 | Green | Color Coded High-Heat Spatula | 295 | 86876231861 |
| 1980418 | Blue | Color Coded High-Heat Spatula | 232 | 86876231878 |
| 1980419 | Yellow | Color Coded High-Heat Spatula | 232 | 86876231885 |
| 1980420 | Purple | Color Coded High-Heat Spatula | 232 | 86876231892 |
| 1980602 | Black | Slim Jim® Resin Trainable Dolly for Slim Jim® Containers | 23 | |
| 1980826 | Black/Chrome | AutoFoam Dispenser with LumeCel™ Technology | 191 | |
| 1980827 | Black/Grey Pearl | AutoFoam Dispenser with LumeCel™ Technology | 191 | |
| 1980828 | White/Grey Pearl | AutoFoam Dispenser with LumeCel™ Technology | 191 | |
| 1980829 | Black/Black Pearl | AutoFoam Dispenser with LumeCel™ Technology | 191 | |
| 1980831 | White/Black Pearl | AutoFoam Dispenser with LumeCel™ Technology | 191 | |
| 1981140 | Green | Color-Coded High-Heat Spatula | 232 | 86876231809 |
| 1981141 | Blue | Color-Coded High-Heat Spatula | 232 | 86876231816 |
| 1981142 | Yellow | Color-Coded High-Heat Spatula | 232 | 86876231823 |
| 1981143 | Purple | Color-Coded High-Heat Spatula | 232 | 86876231830 |
| 1982721 | Brown Stone | Safti-Grip® Bath Mat, Medium | 217 | 86876180084 |

| PART NO. | Color | DESCRIPTION | PAGE | UPC |
|----------|-------------|---|------|-------------|
| 1982724 | White | Safti-Grip® Bath Mat, Medium | 217 | 86876161731 |
| 1982725 | Brown Stone | Safti-Grip® Bath Mat, Large | 217 | 86876180091 |
| 1982726 | White | Safti-Grip® Bath Mat, Large | 217 | 86876159363 |
| 1982728 | Brown Stone | Safti-Grip® Bath Mat, XLarge | 217 | 86876180114 |
| 1982729 | White | Safti-Grip® Bath Mat, XLarge | 217 | 86876180107 |
| 1982727 | White | Safti-Grip® Shower Mat | 217 | 86876180121 |
| 1987863 | | Landfill Label | 56 | |
| 1987865 | | Trash Label | 56 | |
| 1987867 | | Paper Label | 56 | |
| 1987869 | | Mixed Recycling Label | 56 | |
| 1988001 | | Cans Label | 56 | |
| 1988003 | | Plastic Label | 56 | |
| 1988005 | | Bottles/Cans Label | 56 | |
| 1988007 | | Glass Label | 56 | |
| 1988009 | | Organic Waste Label | 56 | |
| 1988011 | | Compost Label | 56 | |
| 1988013 | | Landfill Label | 56 | |
| 1988015 | | Trash Label | 56 | |
| 1988017 | | Paper Label | 56 | |
| 1988019 | | Mixed Recycling Label | 56 | |
| 1988021 | | Cans Label | 56 | |
| 1988023 | | Plastic Label | 56 | |
| 1988025 | | Bottles/Cans Label | 56 | |
| 1988027 | | Glass Label | 56 | |
| 1988029 | | Organic Waste Label | 56 | |
| 1988031 | | Compost Label | 56 | |
| 1997206 | Black | Small Heavy Duty Adaptable Cart | 171 | |
| 1997207 | Gray | Small Heavy Duty Adaptable Cart | 171 | |
| 1997208 | Black | Medium Heavy Duty Adaptable Cart | 171 | |
| 1997209 | Gray | Medium Heavy Duty Adaptable Cart | 171 | |
| 1997227 | Red | Pack Of 4 Accessory Hooks | 171 | |
| 1997230 | Red | Medium Extended Base | 171 | |
| 1997371 | Black | 5" Replacement Caster Set (Locking) | 171 | |
| 1997410 | Red | BRUTE® Construction And Landscape Dolly | 14 | |
| 1997801 | Red | BRUTE® Multi-Surface Dolly | 14 | |
| 1997803 | Black | BRUTE® Anchor Kit – Concrete | 14 | |
| 1997802 | Black | BRUTE® Anchor Kit – Dirt/Grass/Sand | 14 | |
| 2007192 | Red | Closed Lid Insert | 31 | |
| 2007193 | Red | Bottles/Cans Lid Insert | 31 | |
| 2007194 | Red | Paper Slot Lid Insert | 31 | |
| 2007195 | Red | Mixed Recycling Lid Insert | 31 | |
| 2007200 | Yellow | Closed Lid Insert | 31 | |
| 2007881 | Yellow | Bottles/Cans Lid Insert | 31 | |
| 2007882 | Yellow | Paper Slot Lid Insert | 31 | |
| 2007883 | Yellow | Mixed Recycling Lid Insert | 31 | |
| 2007884 | Green | Closed Lid Insert | 31 | |
| 2007885 | Green | Bottles/Cans Lid Insert | 31 | |
| 2007886 | Green | Paper Slot Lid Insert | 31 | |
| 2007887 | Green | Mixed Recycling Lid Insert | 31 | |
| 2007888 | Blue | Closed Lid Insert | 31 | |
| 2007889 | Blue | Bottles/Cans Lid Insert | 31 | |
| 2007890 | Blue | Paper Slot Lid Insert | 31 | |
| 2007891 | Blue | Mixed Recycling Lid Insert | 31 | |
| 2007892 | Black | Closed Lid Insert | 31 | |
| 2007893 | Black | Bottles/Cans Lid Insert | 31 | |
| 2007894 | Black | Paper Slot Lid Insert | 31 | |
| 2007895 | Black | Mixed Recycling Lid Insert | 31 | |
| 2007896 | Dark Grey | Closed Lid Insert | 31 | |
| 2007897 | Dark Grey | Bottles/Cans Lid Insert | 31 | |
| 2007898 | Dark Grey | Paper Slot Lid Insert | 31 | |
| 2007899 | Dark Grey | Mixed Recycling Lid Insert | 31 | |
| 2007900 | Brown | Closed Lid Insert | 31 | |
| 2007902 | Brown | Bottles/Cans Lid Insert | 31 | |

UTILITY AND RECYCLING REFUSE

DECORATIVE REFUSE

CLEANING

MATERIAL HANDLING

WASHROOM

FOODSERVICE

ACCESSORIES & INDEX



| PART NO. | Color | DESCRIPTION | PAGE | UPC |
|----------|---------------------------|---|------|-----|
| 2007903 | Brown | Paper Slot Lid Insert | 31 | |
| 2007904 | Brown | Mixed Recycling Lid Insert | 31 | |
| 2007905 | Red | Billboard | 31 | |
| 2007907 | Yellow | Billboard | 31 | |
| 2007908 | Green | Billboard | 31 | |
| 2007909 | Blue | Billboard | 31 | |
| 2007910 | Black | Billboard | 31 | |
| 2007911 | Dark Grey | Billboard | 31 | |
| 2007912 | Brown | Billboard | 31 | |
| 2007913 | Light Grey | Starter Kit | 30 | |
| 2007914 | Black/Blue | 2-Stream Station Landfill/ Mixed Recycling | 30 | |
| 2007915 | Black/Blue | 2-Stream Station Landfill/Paper | 30 | |
| 2007916 | Black/Yellow | 2-Stream Station Landfill/ Bottles/Cans | 30 | |
| 2007917 | Black/Blue/ Yellow | 3-Stream Station Landfill/ Paper/Bottles/Cans | 30 | |
| 2007918 | Black/Blue/ Green | 3-Stream Station Landfill/ Mixed Recycling/Compost | 30 | |
| 2007919 | Black/Blue/ Red/Yellow | 4-Stream Station Landfill/ Paper/Plastic/Cans | 30 | |
| 2007920 | White | Label Kit: Chinese/English | 31 | |
| 2007921 | White | Label Kit: English (United Kingdom) | 31 | |
| 2007922 | White | Label Kit: French/English (Canada) | 31 | |
| 2007923 | White | Label Kit: Spanish | 31 | |
| 2007924 | White | Label Kit: English (Australia) | 31 | |
| 2017059 | Gray | Spill Mop Pads 10 ct | 158 | |
| 2017060 | Gray | Biohazard Spill Mop Pads 10 ct | 158 | |
| 2017061 | Yellow | Spill Mop Handle | 158 | |
| 2017162 | Gray | Spill Mop Storage Cabinet | 158 | |
| 2017738 | Black | BRUTE® 32G Lid – Open Top | 13 | |
| 2017740 | Red | BRUTE® 32G Lid – Bottles/Cans | 13 | |
| 2017962 | Red | BRUTE® 32G Lid – Open Top | 13 | |
| 2017963 | Yellow | BRUTE® 32G Lid – Open Top | 13 | |
| 2017964 | Dark Green | BRUTE® 32G Lid – Open Top | 13 | |
| 2017965 | Blue | BRUTE® 32G Lid – Open Top | 13 | |
| 2018161 | Yellow | BRUTE® 32G Lid – Bottles/Cans | 13 | |
| 2018162 | Dark Green | BRUTE® 32G Lid – Bottles/Cans | 13 | |
| 2018163 | Blue | BRUTE® 32G Lid – Bottles/Cans | 13 | |
| 2018166 | Red | BRUTE® 32G Lid – Paper | 13 | |
| 2018167 | Yellow | BRUTE® 32G Lid – Paper | 13 | |
| 2018168 | Dark Green | BRUTE® 32G Lid – Paper | 13 | |
| 2018169 | Blue | BRUTE® 32G Lid – Paper | 13 | |
| 2018212 | Red | BRUTE® 32G Lid – Mixed Recycling | 13 | |
| 2018213 | Yellow | BRUTE® 32G Lid – Mixed Recycling | 13 | |
| 2018214 | Dark Green | BRUTE® 32G Lid – Mixed Recycling | 13 | |
| 2018215 | Blue | BRUTE® 32G Lid – Mixed Recycling | 13 | |
| 2018252 | Blue | Slim Jim® Vertical Lid – Open Top | 26 | |
| 2018218 | Red | Slim Jim® Vertical Lid – Open Top | 26 | |
| 2018219 | Yellow | Slim Jim® Vertical Lid – Open Top | 26 | |
| 2018220 | Green | Slim Jim® Vertical Lid – Open Top | 26 | |
| 2018253 | Black | Slim Jim® Vertical Lid – Open Top | 26 | |
| 2018254 | Brown | Slim Jim® Vertical Lid – Open Top | 26 | |
| 2018258 | Blue | Slim Jim® Vertical Lid – Bottles/Cans | 26 | |
| 2018255 | Red | Slim Jim® Vertical Lid – Bottles/Cans | 26 | |
| 2018256 | Yellow | Slim Jim® Vertical Lid – Bottles/Cans | 26 | |
| 2018257 | Green | Slim Jim® Vertical Lid – Bottles/Cans | 26 | |
| 2018260 | Brown | Slim Jim® Vertical Lid – Bottles/Cans | 26 | |
| 2018276 | Blue | Slim Jim® Vertical Lid – Paper | 26 | |
| 2018272 | Red | Slim Jim® Vertical Lid – Paper | 26 | |
| 2018274 | Yellow | Slim Jim® Vertical Lid – Paper | 26 | |
| 2018275 | Green | Slim Jim® Vertical Lid – Paper | 26 | |
| 2018278 | Brown | Slim Jim® Vertical Lid – Paper | 26 | |

| PART NO. | Color | DESCRIPTION | PAGE | UPC |
|----------|--------|---|------|-----|
| 2018302 | Blue | Slim Jim® Vertical Lid – Mixed Recycling | 26 | |
| 2018279 | Red | Slim Jim® Vertical Lid – Mixed Recycling | 26 | |
| 2018280 | Yellow | Slim Jim® Vertical Lid – Mixed Recycling | 26 | |
| 2018301 | Green | Slim Jim® Vertical Lid – Mixed Recycling | 26 | |
| 2018304 | Brown | Slim Jim® Vertical Lid – Mixed Recycling | 26 | |
| 2018385 | Red | Tilt Truck Placard | 166 | |
| 2018386 | Yellow | Tilt Truck Placard | 166 | |
| 2018387 | Green | Tilt Truck Placard | 166 | |
| 2018388 | Blue | Tilt Truck Placard | 166 | |
| 2018389 | Black | Tilt Truck Placard | 166 | |
| 2018390 | Brown | Tilt Truck Placard | 166 | |
| 2018582 | | Enriched Lotion Antibacterial Hand Wash | 194 | |
| 2018595 | | Enriched Foam Antibacterial Hand Wash — E2 | 191 | |
| 2018598 | | Foam Antibacterial Hand Wash — E2 | 198 | |
| 2018727 | Black | Maximizer™ Push-To- Center Broom – 18" MP | 128 | |
| 2018728 | Black | Maximizer™ Push-To- Center Broom – 36" MP | 128 | |
| 2018729 | Gray | Maximizer™ Push-To- Center Broom – 18" Fine | 128 | |
| 2018730 | Gray | Maximizer™ Push-To- Center Broom – 36" Fine | 128 | |
| 2018781 | Black | Maximizer™ Heavy-Duty Stand Up Debris Pan | 134 | |
| 2018782 | Black | Maximizer™ 3-in-1 Floor Prep Tool | 134 | |
| 2018784 | Gray | Maximizer™ 3-in-1 Medium Scrubber Pad | 134 | |
| 2018786 | Green | Maximizer™ 3-in-1 Scuff Remover Pad | 134 | |
| 2018787 | Black | Maximizer™ 3-in-1 Replaceable Scraper | 134 | |
| 2018788 | Black | Maximizer™ Quick Change Storage Tray | 135 | |
| 2018789 | Yellow | Maximizer™ Quick Change Extension Handle | 135 | |
| 2018790 | Black | Maximizer™ Quick Change Duster | 135 | |
| 2018801 | Black | Maximizer™ Quick Change Squeegee | 135 | |
| 2018802 | Black | Maximizer™ Quick Change Scrub Brush | 135 | |
| 2018803 | Black | Maximizer™ Quick Change Floor Prep Tool | 135 | |
| 2018804 | Black | Maximizer™ Quick Change Microfiber Frame | 135 | |
| 2018805 | Black | Maximizer™ Quick Change Cleaning Kit | 135 | |
| 2018806 | Black | Maximizer™ Wet/ Dry Debris Pan | 134 | |
| 2018807 | Black | Maximizer™ Double Sided Broom/Squeegee | 134 | |
| 2018808 | Black | Maximizer™ Dust Frame, Handle, and Scraper – 24" | 124 | |
| 2018809 | Black | Maximizer™ Dust Frame, Handle, and Scraper – 36" | 124 | |
| 2018810 | Yellow | Maximizer™ Dust Mop Pad – 24" | 124 | |
| 2018821 | Yellow | Maximizer™ Dust Mop Pad – 36" | 124 | |
| 2018822 | Black | Maximizer™ EZ Access Scraper – Replacement | 124 | |
| 2018824 | Black | Maximizer™ Overhead Cleaning Tool | 124 | |
| 2018825 | Gray | 11" HYGEN™ Microfiber Window Pad | 124 | |

| PART NO. | Color | DESCRIPTION | PAGE | UPC |
|----------|--------|---|------|-----|
| 2025501 | White | Disposable Wet Mop | 111 | |
| 2025502 | White | Disposable Wet Mop | 111 | |
| 2025503 | White | Disposable Wet Mop | 111 | |
| 2025504 | White | Disposable Wet Mop | 111 | |
| 2025505 | White | Disposable Wet Mop | 111 | |
| 2025506 | White | Disposable Wet Mop | 111 | |
| 2025507 | White | Disposable Wet Mop | 111 | |
| 2025508 | White | Disposable Wet Mop | 111 | |
| 2026695 | Gray | Slim Jim® Under-Counter Container | 33 | |
| 2026696 | Black | Slim Jim® Under-Counter Container | 33 | |
| 2026697 | Brown | Slim Jim® Under-Counter Container | 33 | |
| 2026698 | Beige | Slim Jim® Under-Counter Container | 33 | |
| 2026699 | Blue | Slim Jim® Under-Counter Container | 33 | |
| 2026700 | Green | Slim Jim® Under-Counter Container | 33 | |
| 2026721 | Gray | Slim Jim® Under-Counter Container | 33 | |
| 2026722 | Black | Slim Jim® Under-Counter Container | 33 | |
| 2026723 | Brown | Slim Jim® Under-Counter Container | 33 | |
| 2026724 | Beige | Slim Jim® Under-Counter Container | 33 | |
| 2026725 | Blue | Slim Jim® Under-Counter Container | 33 | |
| 2026726 | Green | Slim Jim® Under-Counter Container | 33 | |
| 2031093 | Gray | Spill Mop Kit | 158 | |
| 2031094 | Gray | Biohazard Spill Mop Kit | 158 | |
| 2031764 | Yellow | 35 qt WaveBrake® Side-Press Bucket and Wringer with Drain | 96 | |
| 2031812 | Green | Wastebasket, Medium | 38 | |
| 2031824 | Blue | Wastebasket, Medium | 38 | |
| 2032955 | Yellow | Slim Jim® Rim Caddy for 23 G Containers | 24 | |
| 2032940 | Black | Slim Jim® Rim Caddy for 23 G Containers | 24 | |
| 2032954 | Yellow | Slim Jim® Rim Caddy Kit | 24 | |
| 2032953 | Black | Slim Jim® Rim Caddy Kit | 24 | |
| 2032952 | Yellow | Slim Jim® 2-Stream Rim Caddy Kit | 24 | |
| 2032936 | Black | Slim Jim® 2-Stream Rim Caddy Kit | 24 | |
| 2036121 | White | Super Stitch® Cotton Scrubbing Wet Mop | 107 | |
| 2036123 | White | Super Stitch® Cotton Scrubbing Wet Mop | 107 | |
| 2036100 | White | Super Stitch® Cotton Scrubbing Wet Mop | 107 | |
| 2040053 | | 18" Fine Pet | 127 | |
| 2039998 | | 24" Fine Pet | 127 | |
| 2040000 | | 24" Fine Tampico | 127 | |
| 2039999 | | 24" Fine Horsehair | 127 | |
| 2040055 | | 18" Multi-Surface | 127 | |
| 2040045 | | 24" Multi-Surface | 127 | |
| 2040046 | | 24" Multi-Surface With Fg Hdl | 127 | |
| 2040054 | | 18" Heavy Duty Polypropylene | 127 | |
| 2040041 | | 24" Heavy Duty Palmyra | 127 | |
| 2040050 | | 24" Heavy Duty Polypropylene | 127 | |
| 2040052 | | 24" Fine Pet Assembled | 127 | |
| 2040049 | | 36" Fine Polypropylene | 127 | |
| 2040048 | | 24" Multi-Surface With Squeegee | 127 | |
| 2040047 | | 24" Medium Polypropylene Assembled | 127 | |
| 2040042 | | 24" Multi-Surface Assembled With Fg Hdl | 127 | |

| PART NO. | Color | DESCRIPTION | PAGE | UPC |
|----------|--------|--|------|-----|
| 2040044 | | 36" Medium Polypropylene Assembled | 127 | |
| 2040043 | | 24" Heavy Duty Polypropylene Assembled | 127 | |
| 2040051 | | 36" Heavy Duty Polypropylene Assembled | 127 | |
| 2044039 | Black | BRUTE® Dome Top for 44-Gallon BRUTE® Container | 13 | |
| 2044040 | | BRUTE® Dome Top for 55-Gallon BRUTE® Container | 13 | |
| 2044151 | Blue | BRUTE® Dome Top for 55-Gallon BRUTE® Container | 13 | |
| 2044152 | Black | BRUTE® Dome Top for 32-Gallon BRUTE® Container | 13 | |
| 2044156 | Blue | BRUTE® Recycling Container without Lid | 12 | |
| 2044160 | White | Wastebasket, Medium | 38 | |
| 2052879 | CLR | FreshWorks™ Produce Set | 227 | |
| 2052933 | CLR | FreshWorks™ Produce Set | 227 | |
| 2052931 | CLR | FreshWorks™ Produce Set | 227 | |
| 2052878 | CLR | FreshWorks™ Produce Set | 227 | |
| 2052936 | WHT | FreshWorks™ Produce Lid | 227 | |
| 2052934 | WHT | FreshWorks™ Produce Lid | 227 | |
| 2052935 | CLR | FreshWorks™ Produce Base | 227 | |
| 2052932 | CLR | FreshWorks™ Produce Base | 227 | |
| 2052983 | CLR | FreshWorks™ Produce Base | 227 | |
| 2052880 | CLR | FreshWorks™ Produce Base | 227 | |
| 2064996 | Yellow | 26 qt WaveBrake® Bucket and Casters | 96 | |
| 2064914 | Yellow | 35 qt WaveBrake® Bucket and Casters | 96 | |
| 2064915 | Yellow | WaveBrake® Side-Press Wringer | 97 | |
| 2064885 | Brown | WaveBrake® Side-Press Wringer | 97 | |
| 2064888 | Blue | WaveBrake® Side-Press Wringer | 97 | |
| 2064884 | Red | WaveBrake® Side-Press Wringer | 97 | |
| 2064912 | Green | WaveBrake® Side-Press Wringer | 97 | |
| 2064960 | Black | WaveBrake® Side-Press Wringer, Executive Series™ | 97 | |
| 2064959 | Yellow | WaveBrake® Down-Press Wringer | 97 | |
| 2065003 | Brown | WaveBrake® Down-Press Wringer | 97 | |
| 2064999 | Blue | WaveBrake® Down-Press Wringer | 97 | |
| 2065001 | Red | WaveBrake® Down-Press Wringer | 97 | |
| 2064953 | Green | WaveBrake® Down-Press Wringer | 97 | |
| 2064994 | Black | WaveBrake® Down-Press Wringer, Executive Series™ | 97 | |
| 2064907 | Red | 35 qt WaveBrake® Dirty Water Bucket | 97 | |
| 2064905 | Gray | 35 qt WaveBrake® Dirty Water Bucket | 97 | |
| 2031763 | Yellow | 35 qt WaveBrake® Bucket and Casters with Drain | 96 | |
| 2067692 | | Bumper Kit for Full Size Housekeeping Carts | 143 | |
| 2067693 | | Bumper Kit for Compact Housekeeping Carts | 143 | |
| 2080802 | | Enriched Foam Alcohol Hand Sanitizer — E3 | 191 | |
| 2080803 | | Foam Alcohol Hand Sanitizer | 198 | |
| 2089820 | Black | 12G Resin Step-On | 36 | |
| 2089821 | Black | 23G Resin Step-On | 36 | |
| 2089824 | Black | 18G Resin Step-On | 36 | |
| 2089825 | Black | 8G Resin Step-On | 36 | |

UTILITY AND RECYCLING REFUSE

DECORATIVE REFUSE

CLEANING

MATERIAL HANDLING

WASHROOM

FOODSERVICE

ACCESSORIES & INDEX



| PART NO. | Color | DESCRIPTION | PAGE | UPC |
|-------------|-------------|---|------|--------------|
| 3485949 | | Microburst® Duet Gentle Breeze/Linen Fresh™ | 205 | 86876206357 |
| 3485950 | | Microburst® Duet Alpine Spring/Mountain Peaks | 205 | 86876206364 |
| 3485951 | | Microburst® Duet Ocean Breeze/Sea Mist | 205 | 86876206371 |
| 3485952 | | Microburst® Duet Cotton Berry/ Refreshing Citrus | 205 | 86876206388 |
| 3486092 | | Microburst® Duet Variety Pack (1 of ea. refill) | 205 | 86876207330 |
| 3486108 | | Light Commercial Microfiber Spray Mop (mop pad not included) | 88 | 86876207446 |
| 3486110 | | 15-oz Replacement Refill Cartridge for 3486108 | 88 | 86876207460 |
| 3486561 | | Enriched Foam Hand Wash | 197 | 86876208528 |
| 3486562 | | Enriched Lotion Hand Wash | 197 | 86876208535 |
| 3486571 | | Enriched Foam Hand Wash | 197 | 86876208627 |
| 3486572 | | Enriched Lotion Hand Wash | 197 | 86876208634 |
| 3486575 | | Enriched Foam Hand & Body Shampoo | 197 | 86876208665 |
| 3486576 | | Enriched Lotion Hand & Body Shampoo | 197 | 86876208672 |
| 3486577 | | Enriched Foam Alcohol Plus Hand Sanitizer — E3 | 197 | 86876208689 |
| 3486579 | | Enriched Foam Alcohol-Free Plus Hand Sanitizer — E3 | 197 | 86876208702 |
| 3486589 | White | Rubbermaid Flex™ Dispenser White — 500 mL | 196 | 86876208801 |
| 3486590 | Black | Rubbermaid Flex™ Dispenser Black — 500 mL | 196 | 86876208818 |
| 3486591 | White | Rubbermaid Flex™ Dispenser White — 1000mL, 1300mL | 196 | 86876208825 |
| 3486592 | Black | Rubbermaid Flex™ Dispenser Black — 1000mL, 1300 mL | 196 | 86876208832 |
| 3486593 | Grey | Rubbermaid Flex™ Manual Dispenser Drip Tray — Grey | 196 | 86876208849 |
| 4870577 | | AutoFlush® Power Adapter Kit | 213 | 86876212969 |
| 20564020 | | Wheel for FG564000 | 186 | 86876213973 |
| 50564205 | | Axle for FG564000 | 186 | 86876217178 |
| 50565400 | | Axle for FG565461 | 186 | 86876183153 |
| 52564200 | | Axle for FG564200 | 186 | |
| 401290ZT | | 2nd Fixture Kit | 214 | 763905012904 |
| FG1000EBK | Black Gloss | Sand Urn | 18 | 97591014905 |
| FG100P00CLR | Clear | Cold Pan | 230 | 86876120691 |
| FG101100BLA | Black | Structural Foam Tilt Truck, Utility-Duty | 164 | 86876184181 |
| FG101300BLA | Black | Structural Foam Tilt Truck, Standard-Duty | 164 | 86876184198 |
| FG101P00CLR | Clear | Cold Pan | 230 | 86876120714 |
| FG10200S | | 200 lb Heavy-Duty Receiving Scale | 236 | |
| FG102500BLA | Black | Tilt Truck, Standard-Duty (RM) | 165 | 86876183764 |
| FG102641BLA | Black | Towable Trainable Tilt Truck, Heavy-Duty (RM) | 166 | |
| FG102600BLA | Black | Tilt Truck, Heavy-Duty (RM) | 165 | 86876183771 |
| FG102542BLA | Black | Forkliftable Tilt Truck, Standard-Duty (RM) | 166 | |
| FG102700BLA | Black | Lid for 1½-Cubic Yard Tilt Trucks | 166 | 86876183849 |
| FG102800BLA | Black | Domed Lid for ¾-Cubic-Yard Tilt Trucks | 164 | 86876184235 |
| FG102P23CLR | Clear | Cold Pan | 230 | 86876172706 |
| FG102P86CLR | Clear | Cold Pan | 230 | 86876123579 |
| FG103500BLA | Black | Tilt Truck, Standard-Duty (RM) | 165 | 86876183788 |
| FG103600BLA | Black | Tilt Truck, Heavy-Duty (RM) | 165 | 86876183795 |
| FG104500BLA | Black | Tilt Truck, Standard-Duty (RM) | 165 | 86876183801 |
| FG104600BLA | Black | Tilt Truck, Heavy-Duty (RM) | 165 | 86876183801 |
| FG104P00CLR | Clear | Cold Pan | 230 | 86876120769 |
| FG105443BLA | Black | Self-Dumping Hopper with four 6" dia (15.2 cm) Polyolefin Casters | 167 | 86876179705 |

| PART NO. | Color | DESCRIPTION | PAGE | UPC |
|---------------|-----------|---|------|-------------|
| FG105943BLA | Black | Self-Dumping Hopper with four 6" dia (15.2 cm) Polyolefin Casters | 167 | 86876183917 |
| FG105P00CLR | Clear | Cold Pan | 230 | 86876120783 |
| FG106P00CLR | Clear | Cold Pan | 230 | 86876120806 |
| FG107443BLA | Black | Self-Dumping Hopper with four 6" dia (15.2 cm) Polyolefin Casters | 167 | 86876183979 |
| FG108P23CLR | Clear | Cold Pan | 230 | 86876172683 |
| FG108P86CLR | Clear | Cold Pan | 230 | 86876120837 |
| FG10B100 | | Heavy-Duty Receiving Scale – Dual-Read | 236 | 77177077050 |
| FG110P00 | Clear | Cold Pan | 230 | |
| FG111P00 | Clear | Cold Pan | 230 | |
| FG112P00 | Clear | Cold Pan | 230 | |
| FG113P00AMBR | Amber | Hot Pan | 292 | 86876142785 |
| FG113P24 | Clear | Cold Pan | 230 | |
| FG114P00 | Clear | Cold Pan | 230 | |
| FG114P86 | Clear | Cold Pan | 230 | |
| FG116P00CLR | Clear | Cold Pan | 230 | 86876120967 |
| FG117P00CLR | Clear | Cold Pan | 230 | 86876120981 |
| FG118P00CLR | Clear | Cold Pan | 230 | 86876121001 |
| FG119P00CLR | Clear | Cold Pan | 230 | 86876121025 |
| FG120P00AMBR | Amber | Hot Pan | 292 | 86876142853 |
| FG120P24CLR | Clear | Cold Pan | 230 | 86876121056 |
| FG121P23CLR | Clear | Cold Pan | 230 | 86876172669 |
| FG121P86CLR | Clear | Cold Pan | 230 | 86876121070 |
| FG123P00CLR | Clear | Cold Pan | 230 | 86876121094 |
| FG124P00CLR | Clear | Cold Pan | 230 | 86876121117 |
| FG125P00CLR | Clear | Cold Pan | 230 | 86876121131 |
| FG126P00CLR | Clear | Cold Pan | 230 | 86876121155 |
| FG127P00AMBR | Amber | Hot Pan | 292 | 86876142921 |
| FG127P24CLR | Clear | Cold Pan | 230 | 86876125009 |
| FG128P23CLR | Clear | Cold Pan | 230 | 86876172645 |
| FG128P86CLR | Clear | Cold Pan | 230 | 86876121186 |
| FG130400BLA | Black | Tilt Truck, Utility-Duty (RM) | 165 | 86876183702 |
| FG130500BLA | Black | Tilt Truck, Standard-Duty (RM) | 165 | 86876183719 |
| FG130500DBLUE | Dark Blue | Tilt Truck, Standard-Duty (RM) | 165 | 86876157215 |
| FG130500RED | Red | Tilt Truck, Standard-Duty (RM) | 165 | 86876157239 |
| FG130500YEL | Yellow | Tilt Truck, Standard-Duty (RM) | 165 | 86876157222 |
| FG130542BLA | Black | Forkliftable Tilt Truck, Standard-Duty (RM) | 166 | 86876179637 |
| FG130573BLUE | Blue | Recycling Tilt Truck, Standard-Duty (RM) | 165 | 86876194302 |
| FG130600BLA | Black | Tilt Truck, Heavy-Duty (RM) | 165 | 86876183726 |
| FG130641BLA | Black | Towable Trainable Tilt Truck, Heavy-Duty (RM) | 166 | 86876183856 |
| FG130700BLA | Black | Lid for ½-Cubic Yard Tilt Trucks | 165 | 86876183825 |
| FG130700BLA | Black | Lid for ½-Cubic-Yard Tilt Trucks | 166 | 86876183825 |
| FG130P00CLR | Clear | Cold Pan | 292 | 86876121193 |
| FG131400BLA | Black | Tilt Truck, Utility-Duty (RM) | 165 | 86876183733 |
| FG131500BLA | Black | Tilt Truck, Standard-Duty (RM) | 165 | 86876183740 |
| FG131500DBLUE | Dark Blue | Tilt Truck, Standard-Duty (RM) | 165 | 86876157246 |
| FG131500RED | Red | Tilt Truck, Standard-Duty (RM) | 165 | 86876157260 |
| FG131500YEL | Yellow | Tilt Truck, Standard-Duty (RM) | 165 | 86876157253 |
| FG131542BLA | Black | Forkliftable Tilt Truck, Standard Duty (RM) | 166 | |
| FG131600BLA | Black | Tilt Truck, Heavy-Duty (RM) | 165 | 86876183757 |
| FG131641BLA | Black | Towable Trainable Tilt Truck, Heavy-Duty (RM) | 166 | 86876183863 |
| FG131700BLA | Black | Lid for 1-Cubic Yard Tilt Trucks | 165 | 86876183832 |
| FG131700BLA | Black | Lid for 1-Cubic-Yard Tilt Trucks | 166 | 86876183832 |
| FG131P00CLR | Clear | Cold Pan | 230 | 86876121216 |
| FG132P00CLR | Clear | Cold Pan | 230 | 86876121230 |
| FG133P00CLR | Clear | Cold Pan | 230 | 86876121254 |
| FG134P00CLR | Clear | Cold Pan | 230 | 86876121278 |
| FG134P86CLR | Clear | Cold Pan | 230 | 86876121285 |
| FG139P00CLR | Clear | Cold Pan | 230 | 86876121308 |

| PART NO. | Color | DESCRIPTION | PAGE | UPC |
|--------------|-------------|--|------|-------------|
| FG140P00CLR | Clear | Cold Pan | 230 | 86876121322 |
| FG141P00CLR | Clear | Cold Pan | 230 | 86876121346 |
| FG142P00WHT | White | Cold Pan | 230 | 86876155730 |
| FG143P00WHT | White | Cold Pan | 230 | 86876155747 |
| FG144P00 | White | Cold Pan | 230 | |
| FG145P00WHT | White | Cold Pan | 230 | 86876155761 |
| FG146P00WHT | White | Cold Pan | 230 | 86876155778 |
| FG147P00WHT | White | Cold Pan | 230 | 86876155785 |
| FG172000GRAY | Gray | Palletote® Lid for FG172100, FG172200 | 187 | 86876001075 |
| FG172000GRAY | Gray | Palletote® Lid for FG172100, FG172200 | 315 | 86876001075 |
| FG172100GRAY | Gray | Palletote® Box | 187 | 86876001136 |
| FG172100GRAY | Gray | Palletote® Box | 315 | 86876001136 |
| FG172200GRAY | Gray | Palletote® Box | 187 | 86876001235 |
| FG172200GRAY | Gray | Palletote® Box | 315 | 86876001235 |
| FG173000GRAY | Gray | Palletote® Lid for FG173100 | 187 | 86876001280 |
| FG173000GRAY | Gray | Palletote® Lid for FG173100 | 315 | 86876001280 |
| FG173100GRAY | Gray | Palletote® Box | 187 | 86876001334 |
| FG173100GRAY | Gray | Palletote® Box | 315 | 86876001334 |
| FG1855BK | Black Gloss | Fits FGMT32, FGH55, FGSBR54 | 38 | 97591006214 |
| FG1855BK | Black Gloss | Steel Drum Top for use w/ 55-Gal Steel Drum, FGSBR52 | 64 | 97591006214 |
| FG1855EGN | Green Gloss | Fits FGMT32, FGH55, FGSBR52 | 38 | 97591000601 |
| FG1855EGN | Green Gloss | Steel Drum Top for use w/ 55-Gal Steel Drum, FGSBR52 | 64 | 97591000601 |
| FG1855RD | Red Gloss | Fits FGMT32, FGH55, FGSBR53 | 38 | 97591019504 |
| FG1855RD | Red Gloss | Steel Drum Top for use w/ 55-Gal Steel Drum, FGSBR52 | 64 | 97591019504 |
| FG190100 | | Scraper | 232 | 86876155464 |
| FG190500 | | Scraper | 232 | 86876155525 |
| FG190600 | | Scraper | 232 | 86876155518 |
| FG191300 | | Scraper-Icing Blade | 232 | 86876155501 |
| FG193300WHT | White | Spoon-Shaped Spatula | 232 | 86876162226 |
| FG193400WHT | White | Spoon-Shaped Spatula | 232 | 86876162233 |
| FG193800WHT | White | Spoon-Shaped Spatula | 232 | 86876162240 |
| FG1962000000 | Red | Color Coded High-Heat Spatula | 295 | 86876232967 |
| FG1963000000 | Red | Color Coded High-Heat Spatula | 295 | 86876148992 |
| FG196200 | Red | Color Coded High-Heat Spatula | 232 | 86876148992 |
| FG196300 | | High-Heat Scraper | 232 | 86876149005 |
| FG196400 | | High-Heat Scraper | 232 | 86876149012 |
| FG196600RED | Red | High-Heat Spoon Scraper | 232 | 86876159684 |
| FG196700RED | Red | High-Heat Spoon Scraper | 232 | 86876159691 |
| FG196800RED | Red | High-Heat Spoon Scraper | 232 | 86876159707 |
| FG199200GRAY | Gray | Closet Organizer/Tool Holder Kit | 148 | 86876127881 |
| FG199300GRAY | Gray | Closet Organizer/Tool Holder Kit | 148 | 86876127898 |
| FG199400YEL | Yellow | Value Kit (2 S-Hooks/ 1 Double Hook) | 148 | 86876127904 |
| FG200500CHAR | Chrome | Heavy-Duty Dust Pan | 132 | 86876116960 |
| FG200P00AMBR | Amber | Hot Pan | 292 | 86876142662 |
| FG201P00AMBR | Amber | Hot Pan | 292 | 86876142679 |
| FG202P23AMBR | Amber | Hot Pan | 292 | 86876172713 |
| FG2030BK | Black | Fits FGMT22, FGH13 | 38 | 97591020708 |
| FG2030BK | Black | Steel Drum Top for use w/ 30-Gal Steel Drum | 64 | 97591020708 |
| FG2030BR | Brown Gloss | Fits FGMT22, FGH14 | 38 | 97591020425 |
| FG2030BR | Brown Gloss | Steel Drum Top for use w/ 30-Gal Steel Drum | 64 | 97591020425 |
| FG2030EGN | Green Gloss | Fits FGMT22, FGH15 | 38 | 97591002520 |
| FG2030EGN | Green Gloss | Steel Drum Top for use w/ 30-Gal Steel Drum | 64 | 97591002520 |
| FG204P00AMBR | Amber | Hot Pan | 292 | 86876142693 |
| FG205P00AMBR | Amber | Hot Pan | 292 | 86876142709 |
| FG206P00AMBR | Amber | Hot Pan | 292 | 86876142716 |
| FG208P23AMBR | Amber | Hot Pan | 292 | 86876172690 |
| FG208P86AMBR | Amber | Hot Pan | 292 | 86876142730 |

| PART NO. | Color | DESCRIPTION | PAGE | UPC |
|---------------|-----------|--|------|-------------|
| FG210P00AMBR | Amber | Hot Pan | 292 | 86876142754 |
| FG211P00AMBR | Amber | Hot Pan | 292 | 86876142761 |
| FG212P00AMBR | Amber | Hot Pan | 292 | 86876142778 |
| FG212P00BLA | Black | Hot Pan | 292 | 86876155860 |
| FG214P00AMBR | Amber | Hot Pan | 292 | 86876142792 |
| FG214P86AMBR | Amber | Hot Pan | 292 | 86876142808 |
| FG216P00AMBR | Amber | Hot Pan | 292 | 86876142815 |
| FG217P00AMBR | Amber | Hot Pan | 292 | 86876142822 |
| FG218800WHT | White | Ironing Organizer | 148 | 86876167016 |
| FG218P00AMBR | Amber | Hot Pan | 292 | 86876142839 |
| FG221P23AMBR | Amber | Hot Pan | 292 | 86876172676 |
| FG221P86AMBR | Amber | Hot Pan | 292 | 86876142877 |
| FG223P00AMBR | Amber | Hot Pan | 292 | 86876142884 |
| FG224P00AMBR | Amber | Hot Pan | 292 | 86876142891 |
| FG225P00AMBR | Amber | Hot Pan | 292 | 86876142907 |
| FG228P23AMBR | Amber | Hot Pan | 292 | 86876172652 |
| FG228P86AMBR | Amber | Hot Pan | 292 | 86876142945 |
| FG230P00AMBR | Amber | Hot Pan | 292 | 86876142952 |
| FG231P00AMBR | Amber | Hot Pan | 292 | 86876142969 |
| FG232P00AMBR | Amber | Hot Pan | 292 | 86876142976 |
| FG234P00AMBR | Amber | Hot Pan | 292 | 86876142990 |
| FG239P00AMBR | Amber | Hot Pan | 292 | 86876143010 |
| FG241P00AMBR | Amber | Hot Pan | 292 | 86876143034 |
| FG245506WHT | Wht | Ironing Organizer | 148 | 86876147704 |
| FG252300BEIG | Beige | Mobile Two-Step Stepstool | 148 | 86876031645 |
| FG252300BLA | Black | Mobile Two-Step Stepstool | 148 | 86876009323 |
| FG253100BLA | Black | Executive Lobby Pro® Dust Pan, Long Handle | 129 | 86876156164 |
| FG253200BLA | Black | Executive Lobby Pro® Dust Pan with Cover, Long Handle | 129 | 86876156171 |
| FG253300BLA | Black | Lobby Pro® Deluxe Upright Dust Pan with Cover and Adjustable Handle Grip | 129 | 86876156188 |
| FG253400BLA | Black | Lobby Pro® Upright Dust Pan Adjustable Handle Grip | 129 | 86876156195 |
| FG253500BLA | Black | Lobby Pro® Upright Dust Pan Hanger Bracket | 133 | 86876156201 |
| FG253600BLA | Black | Executive Lobby Broom w/ Wood Handle | 129 | 86876156232 |
| FG254000BEIG | Beige | Fire-Resistant Wastebasket | 40 | 86876117158 |
| FG254100BEIG | Beige | Fire-Resistant Wastebasket | 40 | 86876117196 |
| FG254100BLA | Black | Fire-Resistant Wastebasket | 40 | 86876117165 |
| FG254100GRAY | Gray | Fire-Resistant Wastebasket | 40 | 86876117172 |
| FG254300BEIG | Beige | Fire-Resistant Wastebasket | 40 | 86876117264 |
| FG254300BLA | Black | Fire-Resistant Wastebasket | 40 | 86876117233 |
| FG254300GRAY | Gray | Fire-Resistant Wastebasket | 40 | 86876117240 |
| FG254400BEIG | Beige | Fire-Resistant Wastebasket | 40 | 86876117295 |
| FG256B00BRN | Brown | Glutton® Container | 64 | 86876011029 |
| FG256B00WHT | Off-White | Glutton® Container | 64 | 86876011043 |
| FG256B73BLUE | Blue | Glutton® Recycling Container | 41 | 86876194142 |
| FG256K00GRAY | Gray | Rigid Liner for Glutton® Container | 64 | 86876011197 |
| FG256L00DBLUE | Dark Blue | Glutton® Bottle and Can Recycling Top for FG256B73 Container | 41 | 86876159882 |
| FG256V00BRN | Brown | Glutton® Hooded Top without doors for FG256B00 Containers | 64 | 86876011241 |
| FG256V00RED | Red | Glutton® Hooded Top without doors for FG256B00 Containers | 64 | 86876011272 |
| FG256X00BRN | Brown | Glutton® Hooded Top with doors for FG256B00 Containers | 64 | 86876011302 |
| FG256X00RED | Red | Glutton® Hooded Top with doors for FG256B00 Containers | 64 | 86876011333 |
| FG257088BEIG | Beige | GroundsKeeper® Smoking Management Receptacle | 66 | 86876166859 |
| FG257088BLA | Black | GroundsKeeper® Smoking Management Receptacle | 66 | 86876166873 |

UTILITY AND RECYCLING REFUSE

DECORATIVE REFUSE

CLEANING

MATERIAL HANDLING

WASHROOM

FOODSERVICE

ACCESSORIES & INDEX



| PART NO. | Color | DESCRIPTION | PAGE | UPC |
|--------------|------------|--|------|-------------|
| FG257088BRN | Brown | GroundsKeeper® Smoking Management Receptacle | 66 | 86876166866 |
| FG258500BLA | Black | Classic Smoking Urn with Metal Ash Tray Top | 65 | 86876011845 |
| FG258600BLA | Black | Classic Smoking Urn, Ash/Trash w/ Metal Ash Tray Top and Metal Liner | 65 | 86876011944 |
| FG260900DGRN | Dark Green | Lid for 10-Gallon BRUTE® Container | 13 | 86876203035 |
| FG260900GRAY | Gray | Lid for 10-Gallon BRUTE® Container | 13 | 86876012385 |
| FG260900RED | Red | Lid for 10-Gallon BRUTE® Container | 13 | 86876203011 |
| FG260900WHT | White | Lid for 10-Gallon BRUTE® Container | 13 | 86876012415 |
| FG260900YEL | Yellow | Lid for 10-Gallon BRUTE® Container | 13 | 86876203028 |
| FG261000DGRN | Dark Green | BRUTE® Container without Lid | 12 | 86876203004 |
| FG261000GRAY | Gray | BRUTE® Container without Lid | 12 | 86876012477 |
| FG261000RED | Red | BRUTE® Container without Lid | 12 | 86876202984 |
| FG261000WHT | White | BRUTE® Container without Lid | 12 | 86876012491 |
| FG261000YEL | Yellow | BRUTE® Container without Lid | 12 | 86876202991 |
| FG261088WHT | White | BRUTE® Container without Lid | 80 | 86876171075 |
| FG261088WHT | White | BRUTE® Container without Lid | 224 | 86876171075 |
| FG261400GRAY | Gray | Round Bucket | 117 | 86876012903 |
| FG261400RED | Red | Round Bucket | 117 | 86876012910 |
| FG261700GRAY | Gray | Double Pail | 117 | 86876013207 |
| FG261960BLA | Black | Lid for 20-Gallon BRUTE® Container | 13 | 86876191752 |
| FG261960DGRN | Dark Green | Lid for 20-Gallon BRUTE® Container | 13 | 86876203073 |
| FG261960GRAY | Gray | Lid for 20-Gallon BRUTE® Container | 13 | 86876191714 |
| FG261960RED | Red | Lid for 20-Gallon BRUTE® Container | 13 | 86876203066 |
| FG261960WHT | White | Lid for 20-Gallon BRUTE® Container | 13 | 86876191738 |
| FG261960YEL | Yellow | Lid for 20-Gallon BRUTE® Container | 13 | 86876191745 |
| FG262000BLU | Blue | BRUTE® Container without Lid | 12 | 86876047462 |
| FG262000DGRN | Dark Green | BRUTE® Container without Lid | 12 | 86876203059 |
| FG262000GRAY | Gray | BRUTE® Container without Lid | 12 | 86876013436 |
| FG262000RED | Red | BRUTE® Container without Lid | 12 | 86876203042 |
| FG262000WHT | White | BRUTE® Container without Lid | 12 | 86876013450 |
| FG262000YEL | Yellow | BRUTE® Container without Lid | 12 | 86876013474 |
| FG262073BLU | Blue | BRUTE® Recycling Container without Lid | 12 | 86876194265 |
| FG262088WHT | White | BRUTE® Container without Lid | 80 | 86876171051 |
| FG262400WHT | White | GreensKeeper® Container with Lid and Dolly | 81 | 86876013979 |
| FG262888GRAY | Gray | Double Pail | 117 | 86876194098 |
| FG263100BLU | Blue | Lid for 32-Gallon BRUTE® Container | 13 | 86876192018 |
| FG263100DGRN | Dark Green | Lid for 32-Gallon BRUTE® Container | 13 | 86876179040 |
| FG263100GRAY | Gray | Lid for 32-Gallon BRUTE® Container | 13 | 86876014655 |
| FG263100RED | Red | Lid for 32-Gallon BRUTE® Container | 13 | 86876014013 |
| FG263100WHT | White | Lid for 32-Gallon BRUTE® Container | 13 | 86876014662 |
| FG263100YEL | Yellow | Lid for 32-Gallon BRUTE® Container | 13 | 86876014051 |
| FG263200BLU | Blue | BRUTE® Container without Lid | 12 | 86876047493 |
| FG263200BLU | Blue | BRUTE® 32-Gallon Container | 141 | 86876047493 |
| FG263200DGRN | Dark Green | BRUTE® Container without Lid | 12 | 86876179026 |
| FG263200DGRN | Dark Green | BRUTE® 32-Gallon Container | 141 | 86876179026 |
| FG263200GRAY | Gray | BRUTE® Container without Lid | 12 | 86876014679 |
| FG263200GRAY | Gray | BRUTE® 32-Gallon Container | 141 | 86876014679 |
| FG263200RED | Red | BRUTE® Container without Lid | 12 | 86876014112 |
| FG263200RED | Red | BRUTE® 32-Gallon Container | 141 | 86876014112 |
| FG263200WHT | White | BRUTE® 32-Gallon Container | 141 | |

| PART NO. | Color | DESCRIPTION | PAGE | UPC |
|--------------|------------|--|------|-------------|
| FG263200WHT | White | BRUTE® Container without Lid | 12 | 86876014136 |
| FG263200YEL | Yellow | BRUTE® Container without Lid | 12 | 86876014150 |
| FG263200YEL | Yellow | BRUTE® 32-Gallon Container | 141 | 86876014150 |
| FG263288WHT | White | BRUTE® Container without Lid | 224 | |
| FG263600WHT | White | GreensKeeper® Container with Lid and Dolly | 81 | 86876015386 |
| FG263600WHT | White | GreensKeeper® Container with Lid and Dolly | 233 | 86876015386 |
| FG263788GRAY | Gray | BRUTE® Dome Top for 32-Gallon BRUTE® Container | 13 | 86876148695 |
| FG263788RED | Red | BRUTE® Dome Top for 32-Gallon BRUTE® Container | 13 | 86876148701 |
| FG264000BLA | Black | BRUTE® Dolly for 20-, 32-, 44-, and 55-Gallon BRUTE® Containers | 14 | 86876015492 |
| FG264000BLA | Black | BRUTE® Dolly for FG9G7400, FG9G7500, FG262000, and FG263200 | 14 | 86876015492 |
| FG264000BLA | Black | BRUTE® Dolly for FG9G7400, FG9G7500, FG262088, and FG263288 | 224 | 86876015492 |
| FG264043BLA | Black | BRUTE® Quiet Dolly for 20-, 32-, 44-, and 55-Gallon BRUTE® Containers | 14 | 86876173208 |
| FG264200YEL | Yellow | BRUTE® Caddy Bag for 32- and 44-Gallon BRUTE® Containers | 15 | 86876015621 |
| FG263273BLU | Blue | BRUTE® Recycling Container without Lid | 12 | 86876191691 |
| FG264307 | Blue | BRUTE® Recycling Container without Lid | 12 | |
| FG264360BLA | Black | BRUTE® Container without Lid | 12 | 86876183566 |
| FG264360BLA | Black | BRUTE® 44-Gallon Utility Container with Venting Channels | 141 | 86876183566 |
| FG264360BLU | Blue | BRUTE® Container without Lid | 12 | 86876183580 |
| FG264360BLU | Blue | BRUTE® 44-Gallon Utility Container with Venting Channels | 141 | 86876183580 |
| FG264360GRAY | Gray | BRUTE® Container without Lid | 12 | 86876183559 |
| FG264360GRAY | Gray | BRUTE® 44-Gallon Utility Container with Venting Channels | 141 | 86876183559 |
| FG264360RED | Red | BRUTE® Container without Lid | 12 | 86876191684 |
| FG264360RED | Red | BRUTE® 44-Gallon Utility Container with Venting Channels | 141 | 86876191684 |
| FG264360YEL | Yellow | BRUTE® Container without Lid | 12 | 86876183573 |
| FG264360YEL | Yellow | BRUTE® 44-Gallon Utility Container with Venting Channels | 141 | 86876183573 |
| FG264560BLA | Black | Lid for 44-Gallon BRUTE® Containers | 13 | 86876183597 |
| FG264560DGRN | Dark Green | Lid for 44-Gallon BRUTE® Containers | 13 | 86876187472 |
| FG264560GRAY | Gray | Lid for 44-Gallon BRUTE® Containers | 13 | 86876187465 |
| FG264560RED | Red | Lid for 44-Gallon BRUTE® Containers | 13 | 86876187489 |
| FG264560WHT | White | Lid for 44-Gallon BRUTE® Containers | 13 | 86876187496 |
| FG264560YEL | Yellow | Lid for 44-Gallon BRUTE® Containers | 13 | 86876187502 |
| FG264600BLA | Black | BRUTE® Tandem Dolly for 20-, 32-, 44-, and 55-Gallon BRUTE® Containers | 14 | 86876161779 |
| FG264788GRAY | Gray | BRUTE® Dome Top for 44-Gallon BRUTE® Container | 13 | 86876148718 |
| FG264788RED | Red | BRUTE® Dome Top for 44-Gallon BRUTE® Container | 13 | 86876148725 |
| FG264900GRAY | Gray | Maid Caddy | 15 | 86876016482 |
| FG265000BLA | Black | Universal Drum Dolly for 55-Gallon BRUTE® Containers | 14 | 86876016499 |
| FG265400DGRN | Dark Green | Lid for 55-Gallon BRUTE® Container | 13 | 86876203127 |

| PART NO. | Color | DESCRIPTION | PAGE | UPC |
|--------------|------------|---|------|-------------|
| FG265400GRAY | Gray | Lid for 55-Gallon BRUTE® Container | 13 | 86876016505 |
| FG265400RED | Red | Lid for 55-Gallon BRUTE® Container | 13 | 86876203141 |
| FG265400WHT | White | Lid for 55-Gallon BRUTE® Container | 13 | 86876203134 |
| FG265400YEL | Yellow | Lid for 55-Gallon BRUTE® Container | 13 | 86876203158 |
| FG265500DGRN | Dark Green | BRUTE® Container without Lid | 12 | 86876203080 |
| FG265500GRAY | Gray | BRUTE® Container without Lid | 12 | 86876005318 |
| FG265500RED | Red | BRUTE® Container without Lid | 12 | 86876203103 |
| FG265500WHT | White | BRUTE® Container without Lid | 12 | 86876203097 |
| FG265500YEL | Yellow | BRUTE® Container without Lid | 12 | 86876203110 |
| FG265788GRAY | Gray | BRUTE® Dome Top for 55-Gallon BRUTE® Container | 13 | 86876148732 |
| FG265788RED | Red | BRUTE® Dome Top for 55-Gallon BRUTE® Container | 13 | 86876148749 |
| FG266400BEIG | Beige | Untouchable® Square Swing Top for FG395800, FG395900 Containers | 37 | 86876016819 |
| FG266400GRAY | Gray | Untouchable® Square Swing Top for FG395800, FG395900 Containers | 37 | 86876057621 |
| FG267200BEIG | Beige | Untouchable® Round Swing Top for FG294700, FG354600 Containers | 37 | 86876016987 |
| FG267360BEIG | Beige | Slim Jim® Swing Lid for Slim Jim® Containers | 26 | 86876203189 |
| FG267360BLA | Black | Slim Jim® Swing Lid for Slim Jim® Containers | 26 | 86876186406 |
| FG267360BLU | Blue | Slim Jim® Swing Lid for Slim Jim® Containers | 26 | 86876187557 |
| FG267360GRAY | Gray | Slim Jim® Swing Lid for Slim Jim® Containers | 26 | 86876187533 |
| FG267400BLA | Black | Executive Slim Jim® Hinged Lid for Slim Jim® Containers | 26 | 86876186413 |
| FG268888L | Gray | Slim Jim® Handle Top | 26 | |
| FG268988BEIG | Beige | Untouchable® Swing Top for FG356907, FG356988 Containers | 37 | 86876192544 |
| FG268988BLA | Black | Untouchable® Swing Top for FG356907, FG356988 Containers | 37 | 86876191486 |
| FG268988GRAY | Gray | Untouchable® Swing Top for FG356907, FG356988 Containers | 37 | 86876203530 |
| FG269000BLU | Blue | Untouchable® Paper Recycling Top for FG356988 Containers | 37 | 86876191493 |
| FG269100BLU | Blue | Untouchable® Bottles and Cans Recycling Top for FG356988 Container | 37 | 86876191509 |
| FG269288BLU | Blue | Slim Jim® Bottles and Cans Recycling Lid for Slim Jim® Containers | 26 | 86876188431 |
| FG269288BRN | Brown | Slim Jim® Bottles and Cans Recycling Lid for Slim Jim® Containers | 26 | 86876147612 |
| FG269288GRN | Green | Slim Jim® Bottles and Cans Recycling Lid for Slim Jim® Containers | 26 | 86876147629 |
| FG269288RED | Red | Slim Jim® Bottles and Cans Recycling Lid for Slim Jim® Containers | 26 | 86876203622 |
| FG269288YEL | Yellow | Slim Jim® Bottles and Cans Recycling Lid for Slim Jim® Containers | 26 | 86876203639 |
| FG270388BLU | Blue | Slim Jim® Paper Recycling Lid for Slim Jim® Containers | 26 | 86876147636 |
| FG270388GRN | Green | Slim Jim® Paper Recycling Lid for Slim Jim® Containers | 26 | 86876191813 |
| FG279100DBLU | Dark Blue | Untouchable® Bottle and Can Recycling Top for FG395873, FG395973 Containers | 37 | 86876156546 |

| PART NO. | Color | DESCRIPTION | PAGE | UPC |
|--------------|------------|--|------|-------------|
| FG279400DBLU | Dark Blue | Untouchable® Paper Recycling Top for FG395806, FG395906 Containers | 37 | 86876156553 |
| FG288200CLR | Clear | Bouncer® Bar Scoop | 233 | 86876017854 |
| FG288400CLR | Clear | Bouncer® Utility Scoop | 233 | 86876017878 |
| FG288500WHT | White | Utility Scoop | 233 | 86876017915 |
| FG288600CLR | Clear | Bouncer® Utility Scoop | 233 | 86876017939 |
| FG289000BLA | Black | Condiment Dispenser with Six 1 U.S. pt (0.5 L) Inserts | 304 | 86876120547 |
| FG294700GRAY | Gray | Untouchable® Round Container | 37 | 86876018288 |
| FG295073BLA | Black | Side Bin Recycling Center | 38 | 86876200584 |
| FG295073BLU | Blue | Side Bin Recycling Center | 38 | 86876200607 |
| FG295073GRAY | Gray | Side Bin Recycling Center | 38 | 86876200591 |
| FG295500BEIG | Beige | Wastebasket, Small | 38 | 86876026030 |
| FG295500BLA | Black | Wastebasket, Small | 38 | 86876026061 |
| FG295500GRAY | Gray | Wastebasket, Small | 38 | 86876018523 |
| FG295573BLU | Blue | Deskside Recycling Container, Small with Universal Recycle Symbol | 38 | 86876194166 |
| FG295600BEIG | Beige | Wastebasket, Medium | 38 | 86876012538 |
| FG295600BLA | Black | Wastebasket, Medium | 38 | 86876018837 |
| FG295600GRAY | Gray | Wastebasket, Medium | 38 | 86876018851 |
| FG295606GRN | Green | Deskside Recycling Container, Medium with Universal Recycle Symbol | 38 | 86876191806 |
| FG295673BLU | Blue | Deskside Recycling Container, Medium with Universal Recycle Symbol | 38 | 86876194173 |
| FG295700BEIG | Beige | Wastebasket, Large | 38 | 86876019162 |
| FG295700BLA | Black | Wastebasket, Large | 38 | 86876019179 |
| FG295700GRAY | Gray | Wastebasket, Large | 38 | 86876019193 |
| FG295773BLU | Blue | Deskside Recycling Container, Large with Universal Recycle Symbol | 38 | 86876194180 |
| FG296300GRAY | Gray | Round Bucket | 116 | 86876019391 |
| FG296300RED | Red | Round Bucket | 116 | 86876019353 |
| FG3062PRPERI | Periwinkle | Economy Pitcher | 305 | 71691012061 |
| FG306409WHT | White | Mixing Pitcher | 305 | 71691306412 |
| FG306600BEIG | Beige | Untouchable® Top for FG295600 Container | 39 | 86876147735 |
| FG306600BLA | Black | Untouchable® Top for FG295600 Container | 39 | 86876147728 |
| FG306700BLA | Black | Untouchable® Top for FG295700 Container | 39 | 86876147742 |
| FG315488BLA | Black | Deluxe Carry Caddy | 149 | 86876193695 |
| FG321000CLR | Clear | Bouncer® Measuring Cup | 233 | 86876019650 |
| FG321500CLR | Clear | Bouncer® Measuring Cup | 233 | 86876019667 |
| FG321600CLR | Clear | Bouncer® Measuring Cup | 233 | 86876019681 |
| FG321700CLR | Clear | Bouncer® Measuring Cup | 233 | 86876019704 |
| FG321800CLR | Clear | Bouncer® Measuring Cup | 233 | 86876019728 |
| FG330000CLR | Clear | Food/Tote Box | 226 | 86876019766 |
| FG330100CLR | Clear | Food/Tote Box | 226 | 86876019780 |
| FG330200CLR | Clear | Lid for FG330000, FG330100, FG330600, FG330800, FG332800 Food/Tote Boxes | 226 | 86876019803 |
| FG330300CLR | Clear | Colander for Tote Boxes 6" deep or greater | 226 | 86876019841 |
| FG330400CLR | Clear | Food/Tote Box | 226 | 86876019865 |
| FG330600CLR | Clear | Food/Tote Box | 226 | 86876019889 |
| FG330700CLR | Clear | Food/Tote Box | 226 | 86876019902 |
| FG330800CLR | Clear | Food/Tote Box | 226 | 86876019926 |
| FG330900CLR | Clear | Food/Tote Box | 226 | 86876019957 |
| FG331000CLR | Clear | Lid for FG330400, FG330700, FG330900 Food/Tote Boxes | 226 | 86876019971 |
| FG331400CLR | Clear | Drain Tray | 226 | 86876206449 |
| FG331500BLA | Black | ProServe® Prep Cart with Cutting Board (8-slot end loader for full-size insert pans) | 240 | 86876155419 |

UTILITY AND RECYCLING REFUSE

DECORATIVE REFUSE

CLEANING

MATERIAL HANDLING

WASHROOM

FOODSERVICE

ACCESSORIES & INDEX



UTILITY AND
RECYCLING REFUSE

DECORATIVE REFUSE

CLEANING

MATERIAL HANDLING

WASHROOM

FOODSERVICE

ACCESSORIES
& INDEX

| PART NO. | Color | DESCRIPTION | PAGE | UPC |
|--------------|-----------|---|------|-------------|
| FG331600BLA | Black | ProServe® Prep Cart with Cutting Board (8-slot side loader for food boxes and sheet pans) | 240 | 86876155426 |
| FG331700BLA | Black | ProServe® Rack (18-slot end loader for full-size insert pans) | 240 | 86876155433 |
| FG331700OWHT | Off-White | ProServe® Rack (18-slot end loader for full-size insert pans) | 240 | 86876149166 |
| FG331800CLR | Clear | Drain Tray | 226 | 86876206456 |
| FG331900OWHT | Off-White | ProServe® Rack (18-slot side loader for food boxes and sheet pans) | 240 | 86876149180 |
| FG332000BLA | Black | ProServe® Rack (18-slot end loader for food boxes and sheet pans) | 240 | 86876155389 |
| FG332000OWHT | Off-White | ProServe® Rack (18-slot end loader for food boxes and sheet pans) | 240 | 86876155372 |
| FG332400BLA | Black | ProServe® Rack 18-slot dual loader for full-size insert pans) | 240 | 86876155402 |
| FG332400OWHT | Off-White | ProServe® Rack 18-slot dual loader for full-size insert pans) | 240 | 86876155396 |
| FG332800CLR | Clear | Food/Tote Box | 226 | 86876020205 |
| FG333100CLR | Clear | Bouncer® II Pitcher | 241 | 86876020274 |
| FG333400CLR | Clear | Bouncer® II Pitcher | 241 | 86876020335 |
| FG333500CLR | Clear | Bouncer® Pitcher | 241 | 86876020342 |
| FG333600CLR | Clear | Bouncer® Pitcher | 241 | 86876020366 |
| FG333700CLR | Clear | Bouncer® Pitcher | 241 | 86876020380 |
| FG333800CLR | Clear | Bouncer® Pitcher | 241 | 86876024234 |
| FG333800GOLD | Gold | Bouncer® Pitcher | 241 | 86876020427 |
| FG333900CLR | Clear | Bouncer® Pitcher | 241 | 86876020472 |
| FG334900GRAY | Gray | Bus/Utility Box | 176 | 86876021011 |
| FG334900GRAY | Gray | Bus/Utility Box | 241 | 86876021011 |
| FG334900WHT | White | Bus/Utility Box | 176 | 86876129694 |
| FG334900WHT | White | Bus/Utility Box | 176 | 86876129694 |
| FG334900WHT | White | Bus/Utility Box | 241 | 86876129694 |
| FG334992GRAY | Gray | Bus/Utility Box, Bulk Pack | 176 | 86876021097 |
| FG334992WHT | White | Bus/Utility Box, Bulk Pack | 241 | 86876155303 |
| FG335000BRN | Brown | Divided Bus/Utility Box | 241 | 86876021103 |
| FG335100BRN | Brown | Undivided Bus/Utility Box | 241 | 86876021141 |
| FG335100GRAY | Gray | Undivided Bus/Utility Box | 241 | 86876021165 |
| FG335192BRN | Brown | Undivided Bus/Utility Box, Bulk Pack | 241 | 86876140989 |
| FG335192GRAY | Gray | Undivided Bus/Utility Box, Bulk Pack | 241 | 86876140996 |
| FG335388BLA | Black | Refuse Bin | 144 | 86876162844 |
| FG335388BLA | Black | Refuse Bin | 176 | 86876162844 |
| FG335388BLA | Black | Refuse Bin | 183 | 86876162844 |
| FG335488BLA | Black | Utility Bin | 144 | 86876162851 |
| FG335488BLA | Black | Utility Bin | 183 | 86876162851 |
| FG335488BLA | Black | Utility Bin | 176 | 86876162851 |
| FG335588PLAT | Platinum | Utility Cart with Enclosed End Panels | 177 | 86876173154 |
| FG336200GRAY | Gray | Cutlery Bin, 4 Compartments | 241 | 86876042979 |
| FG342100BLA | Black | Utility Cart with 3" dia (7.6 cm) Swivel Casters and End Panels | 177 | 86876159530 |
| FG342488BLA | Black | Utility Cart with 4" dia (10.2 cm) Swivel Casters | 313 | 86876159509 |
| FG342488BLA | Black | Utility Cart with 4" dia (10.2 cm) Swivel Casters | 177 | 86876159509 |
| FG342488OWHT | Off-White | Utility Cart with 4" dia (10.2 cm) Swivel Casters | 177 | 86876159516 |
| FG342488OWHT | Off-White | Utility Cart with 4" dia (10.2 cm) Swivel Casters | 313 | 86876159516 |
| FG342488PLAT | Platinum | Utility Cart with 4" dia (10.2 cm) Swivel Casters | 177 | 86876159493 |
| FG342488PLAT | Platinum | Utility Cart with 4" dia (10.2 cm) Swivel Casters | 313 | 86876159493 |
| FG342488RED | Red | Utility Cart with 4" dia (10.2 cm) Swivel Casters | 177 | 86876164718 |
| FG342488RED | Red | Utility Cart with 4" dia (10.2 cm) Swivel Casters | 313 | 86876164718 |

| PART NO. | Color | DESCRIPTION | PAGE | UPC |
|--------------|-------|---|------|-------------|
| FG345600AMBR | Amber | Hot Pan | 230 | 86876142747 |
| FG345700BLA | Black | Utility Cart with Lockable Doors, Sliding Drawer, and 4" dia (10.2 cm) Swivel Casters | 177 | 86876163087 |
| FG350000WHT | White | Food/Tote Box | 226 | 86876022650 |
| FG350100WHT | White | Food/Tote Box | 226 | 86876022711 |
| FG350200WHT | White | Lid for FG350000, FG350100, FG350600, FG350800, FG352800 Food/Tote Boxes | 226 | 86876022759 |
| FG350400WHT | White | Food/Tote Box | 226 | 86876022780 |
| FG350600WHT | White | Food/Tote Box | 226 | 86876022827 |
| FG350700WHT | White | Food/Tote Box | 226 | 86876022858 |
| FG350800WHT | White | Food/Tote Box | 226 | 86876022896 |
| FG350900WHT | White | Food/Tote Box | 226 | 86876022971 |
| FG351000WHT | White | Lid for FG350400, FG350700, FG350900 Food/Tote Boxes | 226 | 86876023046 |
| FG352000BEIG | Beige | Untouchable® Half Round Container | 37 | 86876023121 |
| FG352000GRAY | Gray | Untouchable® Half Round Container | 37 | 86876023138 |
| FG352073BLUE | Blue | Half-Round Recycling Container | 16 | 86876194234 |
| FG352073BLUE | Blue | Half-Round Recycling Container | 37 | 86876194234 |
| FG352600GRAY | Gray | BRUTE® Square Container without Lid | 15 | 86876044294 |
| FG352600RED | Red | BRUTE® Square Container without Lid | 15 | 86876147773 |
| FG352600WHT | White | BRUTE® Square Container without Lid | 15 | 86876044300 |
| FG352700GRAY | Gray | Lid for FG352600 Container | 15 | 86876044324 |
| FG352700WHT | White | Lid for FG352600 Container | 15 | 86876044331 |
| FG352800WHT | White | Food/Tote Box | 226 | 86876023220 |
| FG352900RED | Red | Snap-Lock® Lid for FG352600 Container | 15 | 86876156041 |
| FG353000BLA | Black | BRUTE® Square Dolly for BRUTE® Square Containers | 15 | 86876044355 |
| FG353000BLA | Black | BRUTE® Square Dolly | 156 | 86876044355 |
| FG353000BLA | Black | BRUTE® Square Dolly | 157 | 86876044355 |
| FG353600GRAY | Gray | BRUTE® Square Container without Lid | 15 | 86876044362 |
| FG353600WHT | White | BRUTE® Square Container without Lid | 15 | 86876044379 |
| FG353900GRAY | Gray | Lid for FG353600 Container | 15 | 86876044393 |
| FG353900WHT | White | Lid for FG353600 Container | 15 | 86876044409 |
| FG354007BLUE | Blue | Slim Jim® Container with Venting Channels – Recycling | 22 | 86876186383 |
| FG354007BLUE | Blue | Slim Jim® with Venting Channels – Recycling | 141 | 86876186383 |
| FG354007GRN | Green | Slim Jim® Container with Venting Channels – Recycling | 22 | 86876186390 |
| FG354007GRN | Green | Slim Jim® with Venting Channels – Recycling | 141 | 86876186390 |
| FG354060BEIG | Beige | Slim Jim® Container with Venting Channels | 22 | 86876186369 |
| FG354060BEIG | Beige | Slim Jim® with Venting Channels | 141 | 86876186369 |
| FG354060BLA | Black | Slim Jim® Container with Venting Channels | 22 | 86876186352 |
| FG354060BLA | Black | Slim Jim® with Venting Channels | 141 | 86876186352 |
| FG354060GRAY | Gray | Slim Jim® Container with Venting Channels | 22 | 86876186376 |
| FG354060GRAY | Gray | Slim Jim® with Venting Channels | 141 | 86876186376 |
| FG354300GRAY | Gray | Funnel Top for 32-Gallon BRUTE® Containers | 13 | 86876023428 |
| FG354600GRAY | Gray | Untouchable® Round Container | 37 | 86876023480 |
| FG354800GRAY | Gray | Untouchable® Round Funnel Top for FG294700, FG354600 Containers | 37 | 86876023527 |

| PART NO. | Color | DESCRIPTION | PAGE | UPC |
|--------------|------------|--|------|-------------|
| FG35500GRAY | Gray | Rigid Liner for FG816088 Container | 57 | 86876023534 |
| FG35500GRAY | Gray | Rigid Liner for FG818488, FG818588 Containers | 66 | 86876023534 |
| FG355200GRAY | Gray | Rigid Liner with Rim for FG817088 Container | 57 | 86876023541 |
| FG355200GRAY | Gray | Rigid Liner with Rim for FG818088 and FG818288 Containers | 66 | 86876023541 |
| FG356300BEIG | Beige | Rigid Liner for FG9P9000 and FG9P9100 Containers | 63 | 86876192568 |
| FG356600GRAY | Gray | Rigid Liner for FG843088 | 62 | 86876023657 |
| FG356973BLUE | Blue | Untouchable® Square Recycling Container | 37 | 86876194227 |
| FG356988BEIG | Beige | Untouchable® Square Container | 37 | 86876191431 |
| FG356988BLA | Black | Untouchable® Square Container | 37 | 86876191448 |
| FG356988GRAY | Gray | Untouchable® Square Container | 37 | 86876191424 |
| FG360088WHT | White | Slant-Front Ingredient Bin with Sliding Lid and 32-oz (0.9-L) Scoop | 222 | 86876178142 |
| FG360288WHT | White | Slant-Front Ingredient Bin with Sliding Lid and 32-oz (0.9-L) Scoop | 222 | 86876178159 |
| FG360388WHT | White | Slant-Front Ingredient Bin with Sliding Lid and 32-oz (0.9-L) Scoop | 222 | 86876178166 |
| FG361600WHT | White | Lid for FG369000 Food/Tote Box | 226 | 86876024081 |
| FG362000BLA | Black | Untouchable® Half-Round Lid, with Swing Door for FG352000 Container | 37 | 86876144352 |
| FG364800GRAY | Gray | Lid for FG334900 Bus/Utility Box | 241 | 86876042658 |
| FG369000WHT | White | Food/Tote Box | 226 | 86876025538 |
| FG370612714 | Green | 4.5- Cu.-Ft. Roughneck Lawn Cart Pallet, Green | 186 | 75608370619 |
| FG370712907 | Platinum | 3.25-Cu.-Ft. Roughneck Lawn Cart Pallet, Platinum | 186 | 75608370718 |
| FG395800BEIG | Beige | Untouchable® Square Container (liner for FG396500) | 62 | 86876026528 |
| FG395800BEIG | Beige | Untouchable® Square Container (liner for FG396500) | 37 | 86876026528 |
| FG395800BEIG | Beige | Untouchable® Square Container (liner for FG917100/FG917300/FG396500) | 37 | 86876026528 |
| FG395800GRAY | Gray | Untouchable® Square Container (liner for FG396500) | 63 | 86876057553 |
| FG395800GRAY | Gray | Untouchable® Square Container (liner for FG917100/FG917300/FG396500) | 37 | 86876057553 |
| FG395873BLUE | Blue | Square Recycling Container | 37 | 86876194241 |
| FG395900BEIG | Beige | Untouchable® Square Container (liner for FG917500/FG917600) | 62 | 86876026573 |
| FG395900BEIG | Beige | Untouchable® Square Container (liner for FG917500/FG917600) | 37 | 86876026573 |
| FG395900GRAY | Gray | Untouchable® Square Container (liner for FG917500/FG917600) | 62 | 86876057560 |
| FG395900GRAY | Gray | Untouchable® Square Container (liner for FG917500/FG917600) | 37 | 86876057560 |
| FG395973BLUE | Blue | Square Recycling Container | 37 | 86876194258 |
| FG396300BEIG | Beige | Plaza® Container with Tray Top | 63 | 86876156096 |
| FG396300BLA | Black | Plaza® Container with Tray Top | 63 | 86876156409 |
| FG396400BEIG | Beige | Plaza® Container | 63 | 86876147995 |
| FG396400BLA | Black | Plaza® Container | 63 | 86876156447 |
| FG396400DGRN | Dark Green | Plaza® Container | 63 | 86876148008 |
| FG396500BEIG | Beige | Plaza® Container with Ash tray | 63 | 86876148015 |

| PART NO. | Color | DESCRIPTION | PAGE | UPC |
|---------------|-----------|--|------|-------------|
| FG396600DWOOD | Driftwood | Landmark Series® Classic Container, Ash/Trash Frame with FG356988 Rigid Liner | 60 | 86876039344 |
| FG396600SBLE | Sable | Landmark Series® Classic Container, Ash/Trash Frame with FG356988 Rigid Liner | 60 | 86876039351 |
| FG396700SBLE | Sable | Landmark Series® Classic Container, Funnel Top Frame with FG356988 Rigid Liner | 60 | 86876039375 |
| FG396873BLUE | Blue | Plaza® Bottle and Can Recycling Container | 63 | 86876194357 |
| FG397000BLA | Black | Landmark Series® Classic Container, Dome Top Frame with FG395800 Rigid Liner | 60 | 86876172874 |
| FG397000DWOOD | Driftwood | Landmark Series® Classic Container, Dome Top Frame with FG395800 Rigid Liner | 60 | 86876012989 |
| FG397000SBLE | Sable | Landmark Series® Classic Container, Dome Top Frame with FG395800 Rigid Liner | 60 | 86876013108 |
| FG397001BLA | Black | Landmark Series® Classic Container, Dome Top with Ash Tray, Frame and FG395800 Rigid Liner | 60 | 86876172881 |
| FG397001DWOOD | Driftwood | Landmark Series® Classic Container, Dome Top with Ash Tray, Frame and FG395800 Rigid Liner | 60 | 86876099027 |
| FG397001SBLE | Sable | Landmark Series® Classic Container, Dome Top with Ash Tray, Frame and FG395800 Rigid Liner | 60 | 86876099010 |
| FG397088BLA | Black | Landmark Series® Classic Container, Dome Top Frame with Lock Option, with FG395800 Rigid Liner | 60 | 86876172898 |
| FG397100DWOOD | Driftwood | Landmark Series® Classic Container, Ash/Trash Frame with FG395800 Rigid Liner | 60 | 86876013351 |
| FG397100SBLE | Sable | Landmark Series® Classic Container, Ash/Trash Frame with FG395800 Rigid Liner | 60 | 86876013382 |
| FG397200SBLE | Sable | Landmark Series® Classic Container, Funnel Top Frame with FG395800 Rigid Liner | 60 | 86876029345 |
| FG397500BLA | Black | Landmark Series® Classic Container, Dome Top Frame with FG395900 Rigid Liner | 60 | 86876172904 |
| FG397500BLA | Black | Landmark Series® Classic Container, Dome Top Frame with FG395900 Rigid Liner | 52 | 86876172904 |
| FG397500DWOOD | Driftwood | Landmark Series® Classic Container, Dome Top Frame with FG395900 Rigid Liner | 60 | 86876013467 |
| FG397500DWOOD | Driftwood | Landmark Series® Classic Container, Dome Top Frame with FG395900 Rigid Liner | 52 | 86876013467 |
| FG397500SBLE | Sable | Landmark Series® Classic Container, Dome Top Frame with FG395900 Rigid Liner | 60 | 86876013535 |
| FG397500SBLE | Sable | Landmark Series® Classic Container, Dome Top Frame with FG395900 Rigid Liner | 52 | 86876013535 |
| FG397501BLA | Black | Landmark Series® Classic Container, Dome Top with Ash tray, Frame and FG395900 Rigid Liner | 60 | 86876172911 |
| FG397501BLA | Black | Landmark Series® Classic Container, Dome Top with ash tray, Frame and FG395900 Rigid Liner | 52 | 86876172911 |
| FG397501DWOOD | Driftwood | Landmark Series® Classic Container, Dome Top with ash tray, Frame and FG395900 Rigid Liner | 60 | 86876099041 |

UTILITY AND RECYCLING REFUSE

DECORATIVE REFUSE

CLEANING

MATERIAL HANDLING

WASHROOM

FOODSERVICE

ACCESSORIES & INDEX



| PART NO. | Color | DESCRIPTION | PAGE | UPC |
|---------------|-------------------|--|------|--------------|
| FG397501DWOOD | Driftwood | Landmark Series® Classic Container, Dome Top with ash tray, Frame and FG395900 Rigid Liner | 52 | 86876099041 |
| FG397501SBLE | Sable | Landmark Series® Classic Container, Dome Top with ash tray, Frame and FG395900 Rigid Liner | 60 | 86876099034 |
| FG397501SBLE | Sable | Landmark Series® Classic Container, Dome Top with ash tray, Frame and FG395900 Rigid Liner | 52 | 86876099034 |
| FG397589BLA | Black | Landmark Series® Security Container with Lock and Clear Panels | 52 | 86876173932 |
| FG400055 | | AutoJanitor® BioFlush® Drain Maintenance Refill | 214 | 763905000550 |
| FG400573 | | Standard Aerosol — Vanilla Royale | 206 | 763905005739 |
| FG400586 | | Purinel® SC — Drain Maintainer & Cleaner | 214 | 763905005869 |
| FG400200 | CORL, ROCK | 20G Landmark Series® Panel for FG396600 and FG396700 | 60 | |
| FG400300 | BSTON, CORL, ROCK | 35G Landmark Series® Panel for FG397000, FG397001, FG397088, FG397100, FG397200 | 60 | |
| FG400400 | BSTON, CORL, ROCK | 50G Landmark Series® Panel for FG397500, FG397501 | 60 | |
| FG400600CLR | Clear | Clear Replacement Panel for FG397000, FG397001, FG397088, FG397100, FG397200 Containers | 60 | 86876173840 |
| FG400695 | White | Pump LED Dispenser — White | 263 | 763905006958 |
| FG400696 | | Standard Aerosol — Cinnamon Spice | 206 | 763905006965 |
| FG400700CLR | Clear | Clear Replacement Panel for FG397500, FG397501, FG397589 Containers | 61 | 86876173925 |
| FG400978 | | AutoJanitor® Cleaner & Deodorizer Refill — Linen Fresh™ | 214 | 763905009782 |
| FG400980 | | AutoJanitor® Cleaner & Deodorizer Refill — Mandarin Orange | 214 | 763905009805 |
| FG400982 | | AutoJanitor® Cleaner & Deodorizer Refill — Country Delight™ | 214 | 763905009829 |
| FG4009831 | | Standard Aerosol — Linen Fresh™ | 206 | 763905009836 |
| FG4009841 | | Standard Aerosol — Orchard Fields | 206 | 763905009843 |
| FG4009851 | | Standard Aerosol — Mountain Peaks | 206 | 763905009850 |
| FG400992A | | Pump — Linen Fresh™ | 263 | 763905009928 |
| FG401088 | | Digital Receiving Scale | 236 | 86876207934 |
| FG401186A | | AutoFlush® Sidemount Polished Chrome Urinal | 213 | 763905011860 |
| FG401187A | | AutoFlush® Sidemount Polished Chrome Toilet | 213 | 763905011877 |
| FG401192 | | Pump — Pure | 263 | 763905011921 |
| FG401206A | | AutoFlush® Sidemount Polished Chrome Toilet | 213 | 763905012065 |
| FG401207A | | Auto Flush® Sidemount Polished Chrome Urinal | 213 | |
| FG401231 | | Standard Aerosol — Preference Pack | 206 | 763905012317 |
| FG4012441 | | Microburst® 9000 Refill — Linen Fresh™ | 204 | 763905012447 |
| FG4012451 | | Microburst® 9000 Refill — Orchard Fields | 204 | 763905012454 |
| FG4012461 | | Microburst® 9000 Refill — Mountain Peaks | 204 | 763905012461 |
| FG4012471 | | Microburst® 9000 Refill — Ocean Breeze | 204 | 763905012478 |

| PART NO. | Color | DESCRIPTION | PAGE | UPC |
|-----------|-----------------------|---|------|--------------|
| FG4012481 | | Microburst® 9000 Refill — Country Delight™ | 204 | 763905012485 |
| FG4012491 | | Microburst® 9000 Refill — Preference Pack | 204 | 763905012492 |
| FG4012551 | | Microburst® 3000 Refill — Linen Fresh™ | 203 | 763905012553 |
| FG4012561 | | Microburst® 3000 Refill — Orchard Fields | 203 | 763905012560 |
| FG4012571 | | Microburst® 3000 Refill — Mountain Peaks | 203 | 763905012577 |
| FG4012581 | | Microburst® 3000 Refill — Ocean Breeze | 203 | 763905012584 |
| FG4012591 | | Microburst® 3000 Refill — Country Delight™ | 203 | 763905012591 |
| FG401260A | | Microburst® 3000 Refill — Preference Pack | 203 | 763905012607 |
| FG401266 | | Pump — Mountain Spa™ | 263 | 763905012669 |
| FG401310 | Polished Chrome/Black | OneShot® Liquid Dispenser — Polished Chrome/Black | 194 | 763905013109 |
| FG4013111 | | Enriched Lotion Hand Soap with Moisturizers | 194 | 763905013116 |
| FG4013131 | | Green Certified Lotion Soap | 194 | 763905013130 |
| FG401375 | White | Microburst® 9000 Economizer Dispenser — White | 204 | 763905013758 |
| FG400868 | White | Standard Aerosol Economizer — White | 206 | 763905008686 |
| FG401442 | White | Microburst® 3000 Economizer Dispenser — White | 203 | 763905014427 |
| FG401503 | | Standard Aerosol — Delicious Apple | 206 | 763905015035 |
| FG401504 | | Standard Aerosol — Mandarin Orange | 206 | 763905015042 |
| FG4015061 | | Standard Aerosol — Country Delight™ | 206 | 763905015066 |
| FG401528 | Brushed Chrome/Black | OneShot® Liquid Dispenser — Brushed Chrome/Black | 194 | 763905015288 |
| FG401532 | | AutoClean® Cleaner & Deodorizer Refill — Mandarin Orange | 214 | 763905015325 |
| FG4015411 | | Enriched Lotion Hand Soap with Moisturizers | 194 | 763905015417 |
| FG4015431 | | Green Certified Lotion Soap | 194 | 763905015431 |
| FG401544 | Polished Chrome | Manual Liquid Dispenser — Polished Chrome | 194 | 763905015448 |
| FG4015471 | | Standard Aerosol — Ocean Breeze | 206 | 763905015479 |
| FG401591 | | AutoClean® Cleaner & Deodorizer Refill — Linen Fresh™ | 214 | 763905015912 |
| FG401689 | | Microburst® 3000 Refill — Cinnamon Spice | 259 | 763905016896 |
| FG401690 | | Microburst® 3000 Refill — Mango | 203 | 763905016902 |
| FG401691 | | Microburst® 3000 Refill — Vanilla Royale | 203 | 763905016919 |
| FG401692 | | Microburst® 9000 Refill — Cinnamon Spice | 204 | 763905016926 |
| FG401693 | | Microburst® 9000 Refill — Mango | 204 | 763905016933 |
| FG401694 | | Microburst® 9000 Refill — Vanilla Royale | 204 | 763905016940 |
| FG401695 | | Standard Aerosol — Mango | 206 | 763905016957 |
| FG401804A | | AutoFlush® Clamp Polished Chrome Urinal | 213 | 763905018043 |
| FG401805A | | AutoFlush® Clamp Polished Chrome Toilet | 213 | 763905018050 |
| FG401832 | Polished Chrome/Black | OneShot® Liquid Dispenser Metal Spout — Polished Chrome/Black | 194 | 763905018326 |
| FG401904A | | Pump — Ocean Breeze | 263 | 763905019040 |
| FG401906A | | Pump — Country Delight™ | 263 | 763905019064 |
| FG401909 | | Standard Aerosol — Lemon | 206 | 763905019095 |

| PART NO. | Color | DESCRIPTION | PAGE | UPC |
|--------------|-----------------|---|------|--------------|
| FG401981 | | AutoFlush® Sidemount Polished Chrome Toilet — Metal | 213 | 86876274523 |
| FG401982 | | AutoFlush® Sidemount Polished Chrome Urinal — Metal | 213 | 86876274530 |
| FG402060A | | Auto Flush® Clamp Polished Chrome Urinal - Metal | 213 | |
| FG402059A | | AutoFlush® Clamp Polished Chrome Toilet — Metal | 213 | 763905020596 |
| FG402073 | Polished Chrome | OneShot® Liquid Dispenser — Polished Chrome | 194 | 86876275049 |
| FG402093 | | Microburst® 9000 Refill — Mandarin Orange | 204 | 763905020930 |
| FG402110 | | TCell™ Refill — Wakening Spring | 207 | 763905021104 |
| FG402111 | | TCell™ Refill — Polar Mist | 207 | 763905021111 |
| FG402112 | | TCell™ Refill — Blue Splash | 207 | 763905021128 |
| FG402113 | | TCell™ Refill — Citrus | 207 | 763905021135 |
| FG402187 | | TCell™ Refill — Crystal Breeze | 207 | 763905021876 |
| FG402236 | | TCell™ Refill Preference Pack | 207 | 763905022361 |
| FG402241 | Polished Chrome | OneShot® Liquid Dispenser Low Profile — Polished Chrome | 194 | 763905022415 |
| FG402243 | Polished Chrome | OneShot® Liquid Dispenser Low Profile Metal — Polished Chrome | 194 | 763905022439 |
| FG402310 | White | Clean Seat Foam 400 mL Dispenser — White | 215 | 763905023108 |
| FG402312 | | Clean Seat Foaming Refill | 215 | 763905023122 |
| FG402338 | White | Sanitary Bin 5 Gallon — White | 217 | 763905023382 |
| FG402339 | | Sanitary Bin 5 Gallon Liners — 15 per roll | 217 | 763905023399 |
| FG402348 | | SaniSense Bin Deodorizer™ | 217 | 763905023481 |
| FG402354 | | Microburst® 9000 Refill — Blue Splash | 204 | 763905023542 |
| FG402355 | | Microburst® 3000 Refill — Blue Splash | 203 | 763905023559 |
| FG402363 | | Enriched Lotion Free 'N Clean Soap | 193 | 763905023634 |
| FG402364 | | Enriched Lotion Free 'N Clean Soap | 193 | 763905023641 |
| FG402369 | | TCell™ Refill — Mango Blossom | 207 | 763905023696 |
| FG402408 | | Microburst® 3000 Refill — Mandarin Orange | 203 | 763905024082 |
| FG402430 | | TCell™ Heavy-Duty Dispenser | 207 | 763905024303 |
| FG402470 | | TCell™ Refill — Cucumber Melon | 207 | 763905024709 |
| FG402472 | | TCell™ Refill — Tropical Sunrise | 207 | 763905024723 |
| FG402473 | | TCell™ Refill — Summer Sorbet | 207 | 763905024730 |
| FG402498 | | TCell™ Refill — Pure™ Odor Neutralizer | 207 | 763905024983 |
| FG402537 | | Clean Seat Spray Refill | 215 | 763905525374 |
| FG404088 | | Digital Receiving Scale | 236 | 77177405310 |
| FG409100BLA | Black | Utility Cart, Open-Sided | 177 | 86876148947 |
| FG409100BLA | Black | Utility Cart, Open-Sided | 314 | 86876148947 |
| FG409100GRAY | Gray | Utility Cart, Open-Sided | 177 | 86876145076 |
| FG409100GRAY | Gray | Utility Cart, Open-Sided | 314 | 86876145076 |
| FG409100WHT | Off-White | Utility Cart, Open-Sided | 177 | 86876133424 |
| FG409100WHT | Off-White | Utility Cart, Open-Sided | 314 | 86876133424 |
| FG409300BLA | Black | Utility Cart with Enclosed End Panels on 3 Sides | 177 | 86876153729 |
| FG409300WHT | White | Utility Cart with Enclosed End Panels on 3 Sides | 177 | |
| FG409300BLA | Black | Utility Cart with Enclosed End Panels on 3 Sides | 314 | 86876153729 |
| FG409400GRAY | Gray | Instrument Cart with Lockable Doors and Sliding Drawers | 177 | 86876145069 |
| FG409500BLA | Black | Equipment Cart | 177 | 86876153750 |
| FG409600BLA | Black | 4-Shelf Cart, Open-Sided | 177 | 86876153736 |

| PART NO. | Color | DESCRIPTION | PAGE | UPC |
|--------------|--------|---|------|--------------|
| FG421288BLA | Black | Executive Single-Action Basic Mechanical Sweeper | 147 | 86876187373 |
| FG421388BLA | Black | Executive Dual-Action Bristle Mechanical Sweeper | 147 | 86876187380 |
| FG421588BLA | Black | Executive Dual-Action Brushless Mechanical Sweeper | 147 | 86876187397 |
| FG424288BLA | Black | 100 U.S. Gallon Stock Tank | 185 | 86876190465 |
| FG424300BLA | Black | 50 U.S. Gallon Stock Tank | 185 | 86876186024 |
| FG424700BLA | Black | 300 U.S. Gallon Stock Tank | 185 | 86876186055 |
| FG424806BLA | Black | Stock Tank Float Valve | 185 | 86876186062 |
| FG425100YEL | Yellow | Over-the-Spill® Station Kit includes, Pad Dispenser, 25 Large Pads, and Fasteners | 157 | 86876162486 |
| FG425200YEL | Yellow | Over-the-Spill® Station Pads, Large; Refill Pads for FG425100, Contains 25 Pads | 157 | 86876162493 |
| FG425300YEL | Yellow | Over-the-Spill® Station Pads, Medium; Refill Pads for FG425100, Contains 25 Pads | 157 | 86876162509 |
| FG425400YEL | Yellow | Over-the-Spill® Pad Tablet, Contains 25 Pads | 157 | 86876162516 |
| FG425500YEL | Yellow | Over-the-Spill® Mini Tablet, Contains 22 Pads | 157 | 86876193589 |
| FG430000BLA | Black | Convertible Utility Cart | 175 | 86876191523 |
| FG430000BLA | Black | Convertible Utility Cart | 312 | 86876191523 |
| FG440000BLA | Black | Triple® Trolley, Utility-Duty with Straight Handle and 3" (7.6 cm) Casters | 179 | 86876172997 |
| FG440100BLA | Black | Triple® Trolley, Standard Duty with User-Friendly Handle and 5" dia x .875" w (12.7 cm x 2.22 cm) Casters | 179 | 86876172980 |
| FG440300BLA | Black | Heavy-Duty Platform Truck | 179 | 86876184433 |
| FG440300BLA | Black | Heavy-Duty Platform Truck (Sm 24" x 36") | 315 | 86876184433 |
| FG440600BLA | Black | Heavy-Duty Platform Truck | 179 | 86876184440 |
| FG443600BLA | Black | Heavy-Duty Platform Truck | 179 | 86876184464 |
| FG443600BLA | Black | Heavy-Duty Platform Truck (Med 24" x 48") | 315 | 86876184464 |
| FG443610BLA | Black | Heavy-Duty Platform Truck | 179 | 86876184488 |
| FG444100BLA | Black | Heavy-Duty Platform Truck | 179 | 86876184501 |
| FG446300BLA | Black | A-Frame Panel Truck (24" x 48") | 180 | 86876202526 |
| FG446600BLA | Black | Heavy-Duty Platform Truck | 179 | 86876184532 |
| FG446610BLA | Black | Heavy-Duty Platform Truck | 179 | 86876184556 |
| FG446800BLA | Black | Sheet and Panel Truck (24" x 48") | 180 | 86876202557 |
| FG447100BLA | Black | Heavy-Duty Platform Truck | 179 | 86876184570 |
| FG447700BLA | Black | 5th Wheel Wagon Truck (24" x 48") | 179 | 86876202625 |
| FG448600BLA | Black | Side-Panel Platform Truck (24" x 48") | 181 | 86876202687 |
| FG450007 | White | Spray Dispenser 800 mL — White | 207 | 763905500074 |
| FG450008 | White | Clean Seat Soap Spray 400 mL Dispenser — White | 215 | 763905500081 |
| FG450009 | | Spray Hand Soap with Moisturizers | 207 | 763905500098 |
| FG450011 | | Spray Hand Soap with Moisturizers | 207 | 763905500111 |
| FG450017 | White | Foam Skin Care Dispenser 800 mL — White | 198 | 763905500173 |
| FG450019 | | Foam Hand Soap with Moisturizers | 198 | 763905000192 |
| FG450030 | | Spray Moisturizing Hand Sanitizer — E3 | 255 | 763905500302 |
| FG450034 | Black | Foam Skin Care Dispenser 800 mL — Black | 198 | 763905500340 |
| FG450088BEIG | Beige | Ergo Handle Utility Cart (Med) | 173 | 86876169188 |
| FG450088BEIG | Beige | HD 2-Shelf Utility Cart w/ Lipped Shelf (Small) | 314 | 86876169188 |
| FG450088BLA | Black | Ergo Handle Utility Cart (Med) | 173 | 86876184259 |
| FG450088BLA | Black | HD 2-Shelf Utility Cart w/ Lipped Shelf (Small) | 314 | 86876184259 |



UTILITY AND RECYCLING REFUSE

DECORATIVE REFUSE

CLEANING

MATERIAL HANDLING

WASHROOM

FOODSERVICE

ACCESSORIES & INDEX

| PART NO. | Color | DESCRIPTION | PAGE | UPC |
|---------------|------------------|--|------|--------------|
| FG450089BEIG | Beige | Flat Handle Utility Cart (Small) | 173 | 86876204803 |
| FG450089BLA | Black | Flat Handle Utility Cart (Small) | 173 | 86876204797 |
| FG450500BEIG | Beige | Ergo Handle Utility Cart (Small) | 173 | 86876125078 |
| FG450500BEIG | Beige | HD 2-Shelf Utility Cart Flat Shelf (Small) | 314 | 86876125078 |
| FG450500BLA | Black | Ergo Handle Utility Cart (Small) | 173 | 86876184372 |
| FG450500BLA | Black | HD 2-Shelf Utility Cart Flat Shelf (Small) | 314 | 86876184372 |
| FG450589BLA | Black | Flat Handle Utility Cart (Small) | 173 | 86876204902 |
| FG451288BLA | Black | TradeMaster® Cart with 2-Door Cabinet, Small | 175 | 86876175936 |
| FG451388BLA | Black | TradeMaster® Cart with 4 Drawers | 175 | 86876175943 |
| FG452010BLA | Black | Ergo Handle Utility Cart (Med) with Pneumatic Casters | 173 | 86876184297 |
| FG452088BEIG | Beige | Ergo Handle Utility Cart (Med) | 173 | 86876169201 |
| FG452088BEIG | Beige | HD 2-Shelf Utility Cart w/ Lipped Shelf (Med) | 314 | 86876169201 |
| FG452088BLA | Black | Ergo Handle Utility Cart (Med) | 173 | 86876184280 |
| FG452088BLA | Black | HD 2-Shelf Utility Cart w/ Lipped Shelf (Med) | 314 | 86876184280 |
| FG452089BEIG | Beige | Flat Handle Utility Cart (Med) | 173 | 86876204827 |
| FG452089BLA | Black | Flat Handle Utility Cart (Med) | 173 | 86876204810 |
| FG452500BEIG | Beige | Ergo Handle Utility Cart (Med) | 173 | 86876125092 |
| FG452500BEIG | Beige | HD 2-Shelf Utility Cart Flat Shelf (Med) | 314 | 86876125092 |
| FG452500BLA | Black | Ergo Handle Utility Cart (Med) | 173 | 86876184389 |
| FG452500BLA | Black | HD 2-Shelf Utility Cart Flat Shelf (Med) | 314 | 86876184389 |
| FG452589BLA | Black | Flat Handle Utility Cart (Med) | 173 | 86876204926 |
| FG453388BLA | Black | TradeMaster® Cart with 4 Drawers and Cabinet, Small | 175 | 86876175967 |
| FG454500BLA | Black | Ergo Handle Utility Cart (Large) | 173 | 86876202915 |
| FG454600BLA | Black | Ergo Handle Utility Cart (Large) | 173 | 86876184327 |
| FG454610BLA | Black | Ergo Handle Utility Cart (Large) with Pneumatic Casters | 173 | 86876184334 |
| FG4592000000 | | 8" Replacement Caster Set | 223 | 86876169409 |
| FG4592000000 | | 8" (20.3 cm) Pneumatic Caster Kit | 173 | 86876169409 |
| FG459300 | Red | Extension Drawer | 173 | |
| FG460800BLA | Black | Cube Truck | 168 | 86876183986 |
| FG460900BLA | Black | Lid for 8 ft. ³ Cube Trucks | 168 | 86876184051 |
| FG4610000000 | | Spring Kit for FG461100, FG461400 Trucks | 168 | 86876155440 |
| FG461100BLA | Black | Spring Platform Truck | 168 | 86876184013 |
| FG461200BLA | Black | Cube Truck | 168 | 86876183993 |
| FG461200DBLUE | Dark Blue | Cube Truck | 168 | 86876157307 |
| FG461300BLA | Black | Lid for 12 ft. ³ Cube Trucks | 168 | 86876184068 |
| FG461400BLA | Black | Cube Truck | 168 | 86876184006 |
| FG461500BLA | Black | Lid for 14 ft. ³ Cube Trucks | 168 | 86876184075 |
| FG461500BLA | Black | Lid for 16 ft. ³ Cube Trucks | 168 | 86876184075 |
| FG461600BLA | Black | Cube Truck | 168 | 86876184020 |
| FG461673BLUE | Blue | Recycling Cube Truck | 168 | 86876194319 |
| FG461700BLA | Black | Lid for 20 ft. ³ Cube Trucks | 168 | 86876184082 |
| FG461800BLA | Black | Spring Platform Truck | 168 | 86876184044 |
| FG461900BLA | Black | Cube Truck | 168 | 86876184037 |
| FG470800BLA | Black | Utility Truck, Heavy-Duty with 4" dia (10.2 cm) Casters | 168 | 86876184099 |
| FG471200BLA | Black | Utility Truck, Heavy-Duty with 4" dia (10.2 cm) Casters | 168 | 86876184105 |
| FG471600BLA | Black | Utility Truck, Heavy-Duty with 5" dia (12.7 cm) Casters | 168 | 86876184112 |
| FG472000BLA | Black | Utility Truck, Heavy-Duty with 5" dia (12.7 cm) Casters | 168 | 86876184129 |
| FG472600BLA | Black | Lid for 27 ft. ³ Cube Trucks | 168 | 86876184150 |
| FG472700BLA | Black | Utility Truck, Heavy-Duty with 5" dia (12.7 cm) Corner Casters | 168 | 86876184136 |
| FG472741BLA | Black | Towable Utility Truck, Heavy-Duty | 168 | 86876184143 |
| FG4870001 | White/Grey Pearl | Microburst® Duet Dispenser White/Grey Pearl | 205 | 763905700016 |

| PART NO. | Color | DESCRIPTION | PAGE | UPC |
|--------------|-------------------|--|------|--------------|
| FG4870002 | Black/Black Pearl | Microburst® Duet Dispenser Black/Black Pearl | 205 | 763905700023 |
| FG4870055 | Black/Chrome | Microburst® Duet Dispenser Black/Chrome | 205 | 763905700559 |
| FG4870056 | White/White | Microburst® Duet Dispenser White/White | 205 | 763905700566 |
| FG4870465 | Polished Chrome | OneShot® Foam Dispenser Low Profile Metal — Polished Chrome | 193 | 763905704656 |
| FG500288CLR | Clear | 295200, 295500, 295600, 614200 | 43 | 86876153569 |
| FG500388CLR | Clear | 261000, 294700, 295700, 307120 | 43 | 86876153576 |
| FG500394 | | OneShot® 800 mL Starter Kit (Chrome/Black Dispenser, Hand Wash Refill, 4 D Batteries) | 194 | 763905003940 |
| FG500409 | | AutoClean® LED Dispenser — Chrome (Kit w/ 3/4" Connector) | 214 | 763905004091 |
| FG500410 | | AutoClean® LED Dispenser — Chrome (Kit w/ 1 1/2" Connector) | 214 | 763905004107 |
| FG500449 | | OneShot® 1600 mL Starter Kit (Chrome/Black Dispenser, Hand Wash Refill, 4 D Batteries) | 194 | 763905004497 |
| FG500476 | | AutoClean® Service Dispenser — Chrome (Kit w/ 3/4" Connector) | 214 | 86876280883 |
| FG500488GRAY | Gray | 354600, 816088, 818488, 818588, 614300, 614400, 617700 | 43 | 86876153583 |
| FG500588GRAY | Gray | 352000, 356800, 356900, 782200, 782300, 817088, 818088, 818288, 818588 | 43 | 86876153590 |
| FG500688GRAY | Gray | 262000, 614687 | 43 | 86876153606 |
| FG500788GRAY | Gray | 263200, 263400, 263246, 263256 | 43 | 86876155884 |
| FG500888CLR | Clear | 264100, 264300, 395800, 395900, 905800, 9P9000, 264346, 264356, 9P9100, 965100, 965200 | 43 | 86876155914 |
| FG500988GRAY | Gray | 354000, 354100, 396600, 396700, 614500, 614600, 818288, 355400, 354220 | 43 | 86876155921 |
| FG501088GRAY | Gray | 50-Gal (208.2-L) Drum | 43 | 86876155938 |
| FG501188GRAY | Gray | 265500 | 43 | 86876155945 |
| FG501388CLR | Clear | 256B00, 256B06, 9W2700, 9W2706 | 43 | 86876155969 |
| FG501388GRAY | Gray | 256B00, 256B06, 9W2700, 9W2706 | 43 | 86876155952 |
| FG501688GRAY | Gray | 351700, 352600, 396300, 396400, 396500, 396800, 396900, 397000, 397100, 397200, 397500, 843000, 917100, 917200, 917300 | 43 | 86876155976 |
| FG502888GRAY | Gray | 50-Gallon (189.3-L) Container 9W2700, 9W2706 | 43 | 86876155983 |
| FG505012 | | Stock Tank Drain Plug Kit | 185 | 71691147305 |
| FG507900CLR | Clear | High-Density Coreless Roll Can Liners | 43 | 86876145649 |
| FG511400WHT | Off-White | SeBreeze® Adjustable Fan Dispenser | 263 | 86876126082 |
| FG564200BLA | Black | 7.5-Cu.-Ft. Big Wheel® Cart | 186 | 86876185904 |
| FG564210BLA | Black | 7.5-Cu.-Ft. Heavy-Duty Big Wheel® Cart | 186 | 86876185430 |
| FG565461BLA | Black | 3.5-Cu.-Ft. Big Wheel® Cart (Unassembled) | 186 | 86876185454 |
| FG571473 | Blue | 14-Gallon Recycling Box | 41 | |
| FG571473 | Green | 14-Gallon Recycling Box | 41 | |
| FG571873 | Blue | 18-Gallon Recycling Box | 41 | |
| FG571873 | Green | 18-Gallon Recycling Box | 41 | |
| FG572000WHT | White | Round Storage Container | 229 | 86876131222 |
| FG572024CLR | Clear | Round Storage Container | 229 | 86876131239 |
| FG572100WHT | White | Round Storage Container | 229 | 86876131246 |
| FG572124CLR | Clear | Round Storage Container | 229 | 86876131253 |

| PART NO. | Color | DESCRIPTION | PAGE | UPC |
|--------------|--------|---|------|-------------|
| FG572200YEL | Yellow | Color-Coded Round Container Lid | 229 | 86876131260 |
| FG572500YEL | Yellow | Color-Coded Round Container Lid | 229 | 86876131314 |
| FG572200YEL | Yellow | Lid for FG572000, FG572024, FG572100, FG572124 Round Storage Containers | 229 | 86876131260 |
| FG572300WHT | White | Round Storage Container | 229 | 86876131277 |
| FG572324CLR | Clear | Round Storage Container | 229 | 86876131284 |
| FG572400WHT | White | Round Storage Container | 229 | 86876131291 |
| FG572424CLR | Clear | Round Storage Container | 229 | 86876131307 |
| FG572500YEL | Yellow | Lid for FG572300, FG572324, FG572400, FG572424 Round Storage Containers | 229 | 86876131314 |
| FG573000YEL | Yellow | Color-Coded Round Container Lid | 229 | 86876131406 |
| FG572600WHT | White | Round Storage Container | 229 | 86876131321 |
| FG572624CLR | Clear | Round Storage Container | 229 | 86876131338 |
| FG572700WHT | White | Round Storage Container | 229 | 86876131345 |
| FG572724CLR | Clear | Round Storage Container | 229 | 86876131352 |
| FG572800WHT | White | Round Storage Container | 229 | 86876131369 |
| FG572824CLR | Clear | Round Storage Container | 229 | 86876131376 |
| FG572900WHT | White | Round Storage Container with Bail | 229 | 86876131383 |
| FG572924CLR | Clear | Round Storage Container with Bail | 229 | 86876131390 |
| FG573000YEL | Yellow | Lid for FG572600, FG572624, FG572700, FG572724, FG572800, FG572824, FG572900, FG572924 Round Storage Containers | 229 | 86876131406 |
| FG605SRW | | Dishwasher-Safe Mechanical Portion Control Scale | 235 | 77177404863 |
| FG611000YEL | Yellow | Hanging Safety Sign with Multilingual "Caution" Imprint and Falling Person Symbol | 154 | 86876159677 |
| FG611200YEL | Yellow | Floor Sign with Multilingual "Caution" Imprint, 2-Sided | 155 | 86876032994 |
| FG611277YEL | Yellow | Floor Sign with "Caution Wet Floor" Imprint, 2-Sided | 155 | 86876141702 |
| FG611278YEL | Yellow | Floor Sign with Multilingual "Closed" Imprint, 2-sided | 155 | 86876123470 |
| FG611400YEL | Yellow | Floor Sign with Multilingual "Caution" Imprint, 4-Sided | 155 | 86876123517 |
| FG611477YEL | Yellow | Floor Sign with "Caution Wet Floor" Imprint, 4-Sided | 155 | 86876141719 |
| FG611478YEL | Yellow | Floor Sign with Multilingual "Closed" Imprint, 4-Sided | 155 | 86876123531 |
| FG612788BLU | Blue | Side-Press Wringer for WaveBrake® Mop Bucket | 97 | 86876176605 |
| FG612788BRN | Brown | Side-Press Wringer for WaveBrake® Mop Bucket | 97 | 86876178258 |
| FG612788GRN | Green | Side-Press Wringer for WaveBrake® Mop Bucket | 97 | 86876176599 |
| FG612788RED | Red | Side-Press Wringer for WaveBrake® Mop Bucket | 97 | 86876176582 |
| FG612788YEL | Yellow | Side-Press Wringer for WaveBrake® Mop Bucket | 97 | 86876176575 |
| FG614000WHT | White | Sanitary Napkin Receptacle with Rigid Liner | 217 | 86876034165 |
| FG6141000000 | | Waxed Bags for Sanitary Napkin Receptacle | 217 | |
| FG614300 | Beige | 8G Resin Step-On | 36 | |
| FG614300 | Red | 8G Resin Step-On | 36 | |
| FG614300 | Black | 8G Resin Step-On | 36 | |
| FG614400 | Beige | 12G Resin Step-On | 36 | |
| FG614400 | Red | 12G Resin Step-On | 36 | |
| FG614400 | White | 12G Resin Step-On | 36 | |
| FG614500 | Beige | 18G Resin Step-On | 36 | |
| FG614500 | Red | 182G Resin Step-On | 36 | |
| FG614500 | White | 18G Resin Step-On | 36 | |
| FG614600 | Beige | 23G Resin Step-On | 36 | |
| FG614600 | Red | 23G Resin Step-On | 36 | |

| PART NO. | Color | DESCRIPTION | PAGE | UPC |
|--------------|----------|---|------|-------------|
| FG614600 | White | 23G Resin Step-On | 36 | |
| FG6162000000 | | Dual Waste Wire Bag Holder | 144 | 86876203912 |
| FG6163000000 | | Single Waste Wire Bag Holder | 144 | 86876203905 |
| FG617388BLA | Black | Janitorial Cleaning Cart – Traditional | 139 | 86876192292 |
| FG617388BLU | Blue | Janitorial Cleaning Cart – Traditional | 139 | 86876193176 |
| FG617900BLA | Black | Executive Cart Waste/Bag Lid with Storage – High-Capacity | 139 | 86876180749 |
| FG617900BLA | Black | Executive Cart Waste/Bag Lid with Storage – High-Capacity | 140 | 86876180749 |
| FG618000BLA | Black | Trades Cart with 5" (12.7 cm) Casters includes 2 parts boxes and 4 parts bins | 174 | 86876184419 |
| FG618088BLA | Black | Trades Cart with Locking Cabinet includes 2 parts boxes and 4 parts bins | 174 | 86876184426 |
| FG618100YEL | Yellow | Locking Cabinet Doors | 140 | 86876149630 |
| FG618100YEL | Yellow | Locking Cabinet Doors | 140 | 86876149630 |
| FG618400YEL | Yellow | 20' (6.1 m) Barrier Chain for FG611400 and Safety Cones | 155 | 86876130508 |
| FG618400YEL | Yellow | 20' (50.8 cm) Barrier Chain for G611400 and Safety Cones | 156 | 86876130508 |
| FG618688YEL | Yellow | 44 qt WaveBrake® Side-Press Bucket and Wringer with Drain | 96 | 86876191578 |
| FG618900BLA | Black | Executive Full-Size Housekeeping Cart – Traditional | 142 | 86876192407 |
| FG619000BLA | Black | Executive Compact Housekeeping Cart – Traditional | 142 | 86876192414 |
| FG619100BLA | Black | Executive Full-Size Housekeeping Cart with Doors – Traditional | 142 | 86876192421 |
| FG619200BLA | Black | Executive Compact Housekeeping Cart with Doors – Traditional | 142 | 86876192438 |
| FG619400STL | Steel | Pail and Mop Strainer Combination | 117 | 86876167528 |
| FG619500BLA | Black | Executive Adjustable Shelf Kit for Traditional Housekeeping Carts | 144 | 86876192452 |
| FG619500PLAT | Platinum | Executive Adjustable Shelf Kit for Traditional Housekeeping Carts | 144 | 86876162325 |
| FG619600BLA | Black | Executive Glass Rack for Traditional Housekeeping Carts | 144 | 86876192469 |
| FG619600PLAT | Platinum | Executive Glass Rack for Traditional Housekeeping Carts | 144 | 86876162349 |
| FG619700BLA | Black | Executive Locking Door Kit for Traditional Housekeeping Carts | 144 | 86876192476 |
| FG619900BLA | Black | Executive Locking Utility Drawer – Traditional | 144 | 86876192483 |
| FG627600YEL | Yellow | Safety Cone 36" (91.4 cm) with Multilingual "Caution" Imprint | 156 | 86876162660 |
| FG627677YEL | Yellow | Safety Cone 36" (91.4 cm) with Multilingual "Caution Wet Floor" Imprint | 156 | 86876162677 |
| FG627687YEL | Yellow | Safety Cone 36" (91.4 cm) with Multilingual "Caution Safety First" Imprint | 156 | 86876162684 |
| FG627700YEL | Yellow | Safety Cone 25.75" (65.4 cm) with Multilingual "Caution" Imprint | 156 | 86876162622 |
| FG627777YEL | Yellow | Safety Cone 25.75" (65.4 cm) with Multilingual "Caution Wet Floor" Imprint | 156 | 86876162639 |
| FG628400BLA | Black | Weight Ring – Single for all 36" (91.4 cm) Safety Cones | 66 | 86876162745 |
| FG628400BLA | Black | Weight Ring | 156 | 86876162745 |
| FG628700YEL | Yellow | Cone Barricade System Consists of FG627600, (1) Belt Cassette, and (1) Double Weight Ring | 156 | 86876162738 |

UTILITY AND RECYCLING REFUSE

DECORATIVE REFUSE

CLEANING

MATERIAL HANDLING

WASHROOM

FOODSERVICE

ACCESSORIES & INDEX



| PART NO. | Color | DESCRIPTION | PAGE | UPC |
|---------------|---------|---|------|-------------|
| FG628700YEL | Yellow | Cone Barricade System Consists of FG627600, (1) Belt Cassette, and (1) Double Weight Ring | 157 | 86876162738 |
| FG630200CLR | Clear | Space-Saving Square Container | 228 | 86876043983 |
| FG630400CLR | Clear | Space-Saving Square Container | 228 | 86876043990 |
| FG630600CLR | Clear | Space-Saving Square Container | 228 | 86876044003 |
| FG630800CLR | Clear | Space-Saving Square Container | 228 | 86876044010 |
| FG631000WHT | White | Toilet Bowl Brush, Plastic Handle, Polypropylene Fill | 132 | 86876007213 |
| FG631100WHT | White | Toilet Bowl Brush Holder, fits FG631000 Brush | 132 | 86876007220 |
| FG631200CLR | Clear | Space-Saving Square Container | 228 | 86876044027 |
| FG631800CLR | Clear | Space-Saving Square Container | 228 | 86876044034 |
| FG632000BRN | Brown | Toilet Bowl Brush, Plastic Handle, Polypropylene Fill | 132 | 86876007312 |
| FG632200CLR | Clear | Space-Saving Square Container | 228 | 86876044041 |
| FG632SRW | | Dishwasher-Safe Mechanical Portion Control Scale | 235 | 77177404856 |
| FG633700BLUE | Blue | Floor Scrub, Plastic Block, Bi-level, Polypropylene Fill | 131 | 86876141993 |
| FG634100BLA | Black | Plastic Block Counter Brush, Tampico Fill with 8" (20.3 cm) Bristle Coverage | 132 | 86876142013 |
| FG634200SILV | Silver | Plastic Block Counter Brush, Flagged Polypropylene Fill with 8" (20.3 cm) Bristle Coverage | 132 | 86876142020 |
| FG635100LAC | Lacquer | Wood Handle, Threaded, Lacquered | 128 | 86876007527 |
| FG635200NAT | Natural | Wood Handle, Tapered, Sanded | 128 | 86876007534 |
| FG635500GRAY | Gray | Aluminum Handle, Threaded Plastic Tip, Vinyl Grip | 128 | 86876007572 |
| FG635700BLA | Black | Super Self-Locking Wood Handle, Threaded Metal Tip | 128 | 86876128659 |
| FG636100LAC | Lacquer | Wood Handle, Threaded, Lacquered | 128 | 86876007596 |
| FG636200NAT | Natural | Wood Handle, Tapered, Sanded | 128 | 86876007602 |
| FG636400LAC | Lacquer | Wood Handle, Threaded Metal Tip, Lacquered | 128 | 86876007640 |
| FG637300BRN | Brown | Lobby Broom, 100% Corn Fill | 129 | |
| FG637400BLA | Black | Executive Lobby Broom w/ Vinyl Handle | 129 | 86876154962 |
| FG637500GRAY | Gray | Broom, 1" dia (2.5 cm) Vinyl- Coated Metal Handle, Flagged Polypropylene Fill | 129 | 86876142129 |
| FG638300BLUE | Blue | Corn Broom, Warehouse, 1.13" dia (2.9 cm) Stained/Lacquered Handle | 129 | 86876007824 |
| FG638400ORAN | Orange | Corn Broom, Warehouse, 1.13" dia (2.9 cm) Stained/Lacquered Handle | 129 | 86876007855 |
| FG638500GRAY | Gray | Broom, 1" dia (2.5 cm) Metal Handle, Flagged Polypropylene Fill | 129 | 86876142167 |
| FG638906BLA | Black | Jumbo Smooth Sweep Angle Broom, 17/8" dia (4.76 cm) Black Metal Handle, Polypropylene Fill | 129 | 86876194081 |
| FG639700GRAY | Gray | Broom Replacement Head, Thread fits FG635100, FG635500 Handles | 129 | 86876153514 |
| FG643500BRNZ | Bronze | Steel Sponge Mop with Cellulose Head | 117 | 86876034790 |
| FG643600YEL | Yellow | Steel Cellulose Replacement Head | 117 | 86876034806 |
| FG648200COBLT | Cobalt | Iron Handle Scrub Brush, Polypropylene Fill | 131 | 86876160499 |
| FG650900WHT | White | Color-Coded Square Container Lid | 228 | 86876044102 |
| FG652300WHT | White | Color-Coded Square Container Lid | 228 | 86876044140 |

| PART NO. | Color | DESCRIPTION | PAGE | UPC |
|--------------|----------------------|---|------|--------------|
| FG652300WHT | White | Lid for FG631200, FG631800, FG632200, FG9F0700, FG9F0800, FG9F0900 Space-Saving Containers | 228 | 86876044140 |
| FG738000YEL | Yellow | Tandem™ 31-Qt Bucket and Wringer Combo | 97 | 86876188233 |
| FG748000YEL | Yellow | 26 qt WaveBrake® Side-Press Bucket and Wringer | 95 | 86876184839 |
| FG750112 | | Enriched Foam Hand Soap with Moisturizers | 191 | 763905501125 |
| FG750127 | Black/Black Pearl | AutoFoam Dispenser — Black/Black Pearl | 195 | 763905501279 |
| FG750138 | White/Black Pearl | AutoFoam Dispenser — White/Black Pearl | 195 | 763905501385 |
| FG750139 | Black/Grey Pearl | AutoFoam Dispenser — Black/Grey Pearl | 195 | 763905501392 |
| FG750140 | White/Grey Pearl | AutoFoam Dispenser — White/Grey Pearl | 195 | 763905501408 |
| FG750176 | Metallic | Manual Spray Dispenser 400 mL — Metallic | 255 | 763905501767 |
| FG750243 | White | Sanitary Bin 3 Gallon — White | 217 | 86876283525 |
| FG750244 | Gray | Sanitary Bin 3 Gallon — Gray | 217 | 86876283532 |
| FG750354 | Polished Chrome | Venetian 5.5" in Polished Chrome | 211 | 763905503549 |
| FG750355 | Polished Chrome | Venetian 5.5" Polished Chrome | 211 | 763905503556 |
| FG750362 | | Microburst® 3000 Refill — Green Tea | 203 | 763905503624 |
| FG750363 | | Microburst® 3000 Refill — Cucumber Melon | 203 | 763905503631 |
| FG750366 | | Microburst® 9000 Refill — Cucumber Melon | 204 | 763905503662 |
| FG750386 | | Enriched Foam Hand Soap with Moisturizers | 193 | 763905503860 |
| FG750389 | | Enriched Foam Free 'N Clean Soap — E1 | 193 | 763905503891 |
| FG750390 | | Enriched Foam Free 'N Clean Soap — E1 | 193 | 763905503907 |
| FG750411 | Black/Chrome | AutoFoam Dispenser — Black/Chrome | 195 | 763905504119 |
| FG750443 | | Sanitary Bin 3 Gallon Liners — 15 per roll | 217 | 86876284317 |
| FG750517 | | Enriched Foam Hand Soap with Moisturizers | 193 | 763905505178 |
| FG750537 | | TCell™ Refill — Sugar Cookie | 267 | 763905505376 |
| FG750590 | | Foam Alcohol Hand Sanitizer | 254 | 763905505901 |
| FG750591 | | Enriched Foam Alcohol Hand Sanitizer — E3 | 253 | 763905505918 |
| FG750592 | | Foam Alcohol-Free Hand Sanitizer | 198 | 763905505925 |
| FG750593 | | Enriched Foam Alcohol-Free Hand Sanitizer | 191 | 763905505932 |
| FG750824 | Black | Hand Sanitizer Station (Metal Stand) — Black | 203 | 86876205749 |
| FG750905 | | TCell™ Refill — Vanilla Crème | 207 | 763905509053 |
| FG750907 | | TCell™ Refill — Cinnamon Spice | 207 | 763905509077 |
| FG751001 | | Foam Hair & Body Wash | 198 | 763905510011 |
| FG757088YEL | Yellow | WaveBrake® Bucket | 96 | 86876176537 |
| FG757579YEL | Yellow | Down-Press Wringer for WaveBrake® Bucket | 95 | 86876203172 |
| FG757588BLUE | Blue | Down-Press Wringer for WaveBrake® Bucket | 95 | 86876179354 |
| FG757588BRN | Brown | Down-Press Wringer for WaveBrake® Bucket | 95 | 86876179248 |
| FG757588YEL | Yellow | Down-Press Wringer for WaveBrake® Bucket | 95 | 86876179231 |
| FG757688YEL | Yellow | WaveBrake® 44-Qt Down-Press Combo | 95 | 86876191585 |
| FG757788BRN | Brown | WaveBrake® Down-Press Combo | 95 | 86876179170 |
| FG757788YEL | Yellow | WaveBrake® Down-Press Combo | 95 | 86876179156 |

| PART NO. | Color | DESCRIPTION | PAGE | UPC |
|---------------|----------------|--|------|-------------|
| FG757888BLUE | Blue | WaveBrake® Down-Press Combo | 95 | 86876179293 |
| FG757888GRN | Green | WaveBrake® Down-Press Combo | 95 | 86876179286 |
| FG757888RED | Red | WaveBrake® Down-Press Combo | 95 | 86876179279 |
| FG757900BRN | Brown | WaveBrake® Down-Press Institutional Combo | 95 | |
| FG758088BRN | Brown | 35 qt WaveBrake® Side-Press Bucket and Wringer | 95 | 86876176513 |
| FG758088YEL | Yellow | 35 qt WaveBrake® Side-Press Bucket and Wringer | 95 | 86876176421 |
| FG758888BLUE | Blue | 35 qt WaveBrake® Side-Press Bucket and Wringer | 95 | 86876176506 |
| FG758888GRN | Green | 35 qt WaveBrake® Side-Press Bucket and Wringer | 95 | 86876176490 |
| FG758888RED | Red | 35 qt WaveBrake® Side-Press Bucket and Wringer | 95 | 86876176483 |
| FG759088YEL | Yellow | 35 qt WaveBrake® Institutional Bucket and Sieve Wringer | 96 | 86876179187 |
| FG773488BLA | Black | 5-Drawer Mobile Work Center | 174 | 86876160031 |
| FG780508BLA | Black | Sturdy Chair™ Youth Seat with Wheels | 242 | 86876204704 |
| FG780508DGRN | Dark Green | Sturdy Chair™ Youth Seat with Wheels | 242 | 86876204728 |
| FG780508PLAT | Platinum | Sturdy Chair™ Youth Seat with Wheels | 242 | 86876204711 |
| FG780608BLA | Black | Sturdy Chair™ Youth Seat without Wheels | 242 | 86876204735 |
| FG780608DGRN | Dark Green | Sturdy Chair™ Youth Seat without Wheels | 242 | 86876204759 |
| FG780608PLAT | Platinum | Sturdy Chair™ Youth Seat without Wheels | 242 | 86876204742 |
| FG781408BLA | Black | Sturdy Chair™ Youth Seat, RTA (ready to assemble), No Wheels | 242 | 86876204766 |
| FG781408DGRN | Dark Green | Sturdy Chair™ Youth Seat, RTA (ready to assemble), No Wheels | 242 | 86876204780 |
| FG781408PLAT | Platinum | Sturdy Chair™ Youth Seat, RTA (ready to assemble), No Wheels | 242 | 86876204773 |
| FG781588BLA | Black | Tray for FG780508, FG780608, and FG781408 Chairs | 242 | 86876193831 |
| FG781588DGRN | Dark Green | Tray for FG780508, FG780608, and FG781408 Chairs | 242 | 86876188158 |
| FG781588PLAT | Platinum | Tray for FG780508, FG780608, and FG781408 Chairs | 242 | 86876188127 |
| FG781588RED | Red | Tray for FG780508, FG780608, and FG781408 Chairs | 242 | 86876188134 |
| FG781788WHT | White | Protective Liners for Baby Changing Stations, Laminated 2-Ply Tissue Paper | 216 | 86876193657 |
| FG781888LPLAT | Light Platinum | Baby Changing Station Horizontal | 216 | 86876192582 |
| FG781988LPLAT | Light Platinum | Baby Changing Station Vertical | 216 | 86876192599 |
| FG782200BEIG | Beige | Slim Jim® Wall-Mounted Container | 40 | 86876125511 |
| FG782200BRN | Brown | Slim Jim® Wall-Mounted Container | 40 | 86876125535 |
| FG810W | | Washable Mechanical Portion Control Scale | 235 | 77177404702 |
| FG816088BEIG | Beige | Marshal® Classic Container | 57 | 86876157017 |
| FG816088BLA | Black | Marshal® Classic Container | 57 | 86876157024 |
| FG816088BRN | Brown | Marshal® Classic Container | 57 | 86876157031 |
| FG816088OWHT | Off-White | Marshal® Classic Container | 57 | 86876157048 |
| FG817088BEIG | Beige | Marshal® Classic Container | 57 | 86876156881 |
| FG817088BLA | Black | Marshal® Classic Container | 57 | 86876156898 |
| FG817088BRN | Brown | Marshal® Classic Container | 57 | 86876156904 |
| FG817088OWHT | Off-White | Marshal® Classic Container | 57 | 86876156911 |
| FG818088BEIG | Beige | Ash/Trash Classic Container with Doors | 66 | 86876156935 |
| FG818088BRN | Brown | Ash/Trash Classic Container with Doors | 66 | 86876156959 |
| FG818288BEIG | Beige | Ash/Trash Classic Container without Doors | 66 | 86876156973 |

| PART NO. | Color | DESCRIPTION | PAGE | UPC |
|---------------|---------------|--|------|-------------|
| FG818488BEIG | Beige | Ash/Trash Classic Container with Doors | 66 | 86876157062 |
| FG818588BEIG | Beige | Ash/Trash Classic Container without Doors | 66 | 86876184990 |
| FG820BW | | Washable Mechanical Portion Control Scale | 235 | 77177404719 |
| FG8315ASWHT | White | Measuring Cup Set | 232 | 71691005063 |
| FG8316ASWHT | White | Measuring Spoon Set | 232 | 71691831631 |
| FG832W | | Washable Mechanical Portion Control Scale | 235 | 77177404764 |
| FG832WQ | | Washable Mechanical Portion Control Scale w/ QuickStop | 235 | 77177404757 |
| FG840W | | Washable Mechanical Portion Control Scale | 235 | 77177404665 |
| FG843088BEIG | Beige | 35-Gallon Ranger® Container | 62 | 86876187243 |
| FG843088BLA | Black | 35-Gallon Ranger® Container | 62 | 86876187960 |
| FG905800BLA | Black | Atrium® Classic Container with Funnel Top | 59 | 86876156379 |
| FG905886WGRAN | White Granite | Atrium® Classic Container with Funnel Top | 59 | 86876162820 |
| FG917188BEIG | Beige | 45-Gallon Ranger® Container with 2 Doors | 62 | 86876187267 |
| FG917188BLA | Black | 45-Gallon Ranger® Container with 2 Doors | 62 | 86876187250 |
| FG917388BEIG | Beige | 45-Gallon Ranger® Container with 4 Openings | 62 | 86876187281 |
| FG917388BLA | Black | 45-Gallon Ranger® Container with 4 Openings | 62 | 86876187274 |
| FG917500BEIG | Beige | 65-Gallon Ranger® Container with 2 Doors | 62 | 86876187304 |
| FG917500BLA | Black | 65-Gallon Ranger® Container with 2 Doors | 62 | 86876187298 |
| FG917600BEIG | Beige | 65-Gallon Ranger® Container with 4 Openings | 62 | 86876187328 |
| FG917600BLA | Black | 65-Gallon Ranger® Container with 4 Openings | 62 | 86876187311 |
| FG917700BEIG | Beige | Weighted Base Accessory for 45- and 65-Gallon Ranger® Containers | 62 | 86876187342 |
| FG917700BLA | Black | Weighted Base Accessory for 45- and 65-Gallon Ranger® Containers | 62 | 86876187335 |
| FG9B2200BRN | Brown | Plastic Foam Block, Medium Floor Sweep, Tampico Fill | 128 | 86876164091 |
| FG9B2900YEL | Yellow | Short Plastic-Handle Utility Brush, Synthetic Fill | 130 | 86876164169 |
| FG9B3200YEL | Yellow | Long Plastic-Handle Utility Brush, Synthetic Fill | 130 | 86876164190 |
| FG9B3400BRN | Brown | Deck Brush, Plastic Block, Palmyra Fill | 131 | 86876164213 |
| FG9B3600YEL | Yellow | Deck Brush, Plastic Block, Polypropylene Fill | 131 | 86876164237 |
| FG9B3700GRAY | Gray | Wash Brush, Plastic Block, Flagged Polystyrene Fill | 131 | 86876164244 |
| FG9B4400GRAY | Gray | Wire Brush with Scraper, Long Plastic Handle | 131 | 86876164329 |
| FG9B5500YEL | Yellow | Corn Whisk Broom | 129 | 86876164411 |
| FG9B5600BLA | Black | Tile and Grout Brush, Plastic Bristles | 131 | 86876164428 |
| FG9B57000000 | | Tile and Grout Brush, Brass Bristles | 131 | 86876164435 |
| FG9B5900BLA | Black | Extra-Large Dust Pan | 132 | 86876164459 |
| FG9B6000BLA | Black | Jumbo Dust Pan | 132 | 86876164466 |
| FG9B7200GRN | Green | Wash Brush, Plastic Block, Nylon Fill | 131 | 86876164251 |
| FG9C03060000 | | Executive Spray Bottle, 32-oz. 30"-42" (76.2 cm-106.6 cm) Lambswool Duster with Telescoping Plastic Handle | 149 | 86876180053 |
| FG9C04000000 | | | 125 | 86876169102 |
| FG9C2600BLA | Black | 18" (45.7 cm) Standard Floor Squeegee | 133 | 86876170450 |
| FG9C2700BLA | Black | 22" (55.9 cm) Standard Floor Squeegee | 133 | 86876170467 |

UTILITY AND RECYCLING REFUSE

DECORATIVE REFUSE

CLEANING

MATERIAL HANDLING

WASHROOM

FOODSERVICE

ACCESSORIES & INDEX



| PART NO. | Color | DESCRIPTION | PAGE | UPC |
|---------------|-----------|---|------|-------------|
| FG9C2800BLA | Black | 22" (55.9 cm) Heavy-Duty Floor Squeegee | 133 | 86876170474 |
| FG9C2900BLA | Black | 30" (76.2 cm) Heavy-Duty Floor Squeegee | 133 | 86876170481 |
| FG9C3100BLA | Black | 18" (45.7 cm) Straight Floor Squeegee | 133 | 86876170702 |
| FG9C3200BLA | Black | 24" (61 cm) Straight Floor Squeegee | 133 | 86876170719 |
| FG9C3300BLA | Black | 36" (91.4 cm) Straight Floor Squeegee | 133 | 86876170726 |
| FG9C3400BLA | Black | 24" (61 cm) Curved Floor Squeegee | 133 | 86876170733 |
| FG9C3500BLA | Black | 18" (45.7 cm) Replacement Blade for FG9C3100 | 133 | 86876170740 |
| FG9C3600BLA | Black | 24" (61 cm) Replacement Blade for FG9C3200 | 133 | 86876170757 |
| FG9C3700BLA | Black | 36" (91.4 cm) Replacement Blade for FG9C3300 | 133 | 86876170764 |
| FG9C4100BLA | Black | 18" (45.7 cm) Plastic Professional Squeegee with Black Dual Moss Rubber | 133 | 86876170672 |
| FG9C4200BLA | Black | 18" (45.7 cm) Plastic Scrub and Dry Squeegee with Black Dual Moss Rubber | 133 | 86876170818 |
| FG9C7400RED | Red | Dirty Water Bucket for WaveBrake® Combos | 97 | 86876176629 |
| FG9C7400YEL | Yellow | Dirty Water Bucket for WaveBrake® Combos | 97 | 86876176612 |
| FG9C83010000 | | SeBreeze® Odor-absorbing Gel — Fresh Apple | 263 | 86876177138 |
| FG9C84010000 | | SeBreeze® Odor-absorbing Gel — Citrus Breeze | 263 | 86876177022 |
| FG9C85010000 | | SeBreeze® Odor-absorbing Gel — Ocean Breeze | 263 | 86876177039 |
| FG9F1200CGRAY | Cool Gray | ProServe® Insulated End-Load, Full-Pan Carrier, Small | 238 | 86876166750 |
| FG9F1300CGRAY | Cool Gray | ProServe® Insulated End-Load, Full-Pan Carrier, Medium | 238 | 86876166767 |
| FG9F1400CGRAY | Cool Gray | ProServe® Insulated End-Load, Full-Pan Carrier, Large | 238 | 86876166774 |
| FG9F1500CGRAY | Cool Gray | ProServe® Insulated Top-Load, Half-Pan Carrier | 238 | 86876166781 |
| FG9F1600CGRAY | Cool Gray | ProServe® Insulated Top-Load, Full-Pan Carrier | 238 | 86876166798 |
| FG9F1900BLA | Black | ProServe® Insulated Carrier Dolly with Retention Strap | 238 | 86876166828 |
| FG9F3500RED | Red | ProServe® Pizza Delivery Bag, Small | 239 | 86876172577 |
| FG9F3600RED | Red | ProServe® Pizza Delivery Bag, Medium | 239 | 86876172584 |
| FG9F3700RED | Red | ProServe® Pizza Delivery Bag, Large | 239 | 86876172591 |
| FG9F3800RED | Red | ProServe® Pizza/Catering/Sandwich Delivery Bag, Medium | 239 | 86876172607 |
| FG9F3900RED | Red | ProServe® Pizza/Catering/Sandwich Delivery Bag, Large | 239 | 86876172614 |
| FG9F4000RED | Red | ProServe® Sandwich Delivery Bag | 239 | 86876172621 |
| FG9F43000000 | | Scoop Holder | 237 | 86876200362 |
| FG9F5000TBLE | Blue | 74-oz Scoop with Hand Guard | 237 | 86876200348 |
| FG9F5100TBLE | Blue | 74-oz Scoop with Hand Guard and Holder | 237 | 86876200355 |
| FG9F5300TBLE | Blue | Ice Tote | 237 | 86876200386 |
| FG9F5400TBLE | Blue | Ice Tote with Bin Hook Adapter | 237 | 86876200393 |
| FG9F5500BLA | Black | Ice Cart | 237 | 86876202427 |
| FG9F5600 | | Ice Bin Hook Adapter | 237 | |
| FG9F7300BLA | Black | Ice Tote Lid | 237 | 86876201772 |
| FG9F7500CLR | Clear | Bouncer® Contour Scoop for FG360088, FG360288, FG360388 Ingredient Bins (32-oz scoop) | 233 | 86876176773 |

| PART NO. | Color | DESCRIPTION | PAGE | UPC |
|--------------|--------|---|------|-------------|
| FG9F7600CLR | Clear | Bouncer® Contour Scoop for FG360088, FG360288, FG360388 Ingredient Bins and FG9G7800 | 223 | 86876176780 |
| FG9F7600CLR | Clear | Bouncer® Contour Scoop for FG360088, FG360288, FG360388 Ingredient Bins (64-oz scoop) | 233 | 86876176780 |
| FG9F7700CLR | Clear | Sliding Lid with 32-oz (0.9-L) Scoop for FG360088 Ingredient Bin | 222 | 86876176797 |
| FG9F7800CLR | Clear | Sliding Lid with 32-oz (0.9-L) Scoop for FG360288 Ingredient Bin | 222 | 86876176803 |
| FG9F7900CLR | Clear | Sliding Lid with 32-oz (0.9-L) Scoop for FG360388 Ingredient Bin | 222 | 86876176810 |
| FG9F8600WHT | White | "ICE ONLY" Container | 81 | 86876173086 |
| FG9F8600WHT | White | "ICE ONLY" Container | 237 | 86876173086 |
| FG9F9000CLR | Clear | Vinyl Rack Cover for FG9F9700, FG332000 Racks | 239 | 86876169508 |
| FG9F9700BLA | Black | ProServe® Standard Base Sheet Pan Rack | 239 | 86876166507 |
| FG9G5100CLR | Clear | Bouncer® Portioning Scoop for FG9G5700, FG9G5800 Shelf Ingredient Bins and FG9G7600, FG9G7300 | 223 | 86876183610 |
| FG9G5100CLR | Clear | Bouncer® Portioning Scoop — 2 Cup | 233 | 86876183610 |
| FG9G5200CLR | Clear | Bouncer® Portioning Scoop for FG9G7700, FG9G7400 Sliding Lid | 223 | 86876183627 |
| FG9G5200CLR | Clear | Bouncer® Portioning Scoop — 3 Cup | 233 | 86876183627 |
| FG9G5300CLR | Clear | Bouncer® Portioning Scoop for FG9G7800, FG9G7500 Sliding Lid | 223 | 86876183634 |
| FG9G5300CLR | Clear | Bouncer® Portioning Scoop — 4 Cup | 233 | 86876183634 |
| FG9G5400CLR | Clear | Bouncer® Portioning Scoop — 8 Cup | 233 | 86876183641 |
| FG9G5700WHT | White | 100-Cup Shelf Ingredient Bin with 2-Cup Scoop | 222 | 86876189957 |
| FG9G5800WHT | White | 200-Cup Shelf Ingredient Bin with 2-Cup Scoop | 222 | 86876189964 |
| FG9G5900CHRM | Chrome | Cart for Shelf Ingredient Bins | 223 | 86876189971 |
| FG9G6000WHT | White | 40-Cup Shelf Ingredient Bin with 1/2-Cup Scoop | 222 | 86876203578 |
| FG9G7300WHT | White | Sliding Lid w/ 2-Cup Scoop and FG261000 BRUTE® Container COMBO | 80 | 86876203745 |
| FG9G7300WHT | White | Sliding Lid w/ 2-Cup Scoop and FG261088 BRUTE® Container COMBO | 224 | 86876203745 |
| FG9G7400WHT | White | Sliding Lid w/ 3-Cup Scoop and FG262000 BRUTE® Container COMBO | 80 | 86876203752 |
| FG9G7400WHT | White | Sliding Lid w/ 3-Cup Scoop and FG262088 BRUTE® Container COMBO | 224 | 86876203752 |
| FG9G7500WHT | White | Sliding Lid w/ 4-Cup Scoop and FG263200 BRUTE® Container COMBO | 80 | 86876203769 |
| FG9G7500WHT | White | Sliding Lid w/ 4-Cup Scoop and FG263288 BRUTE® Container COMBO | 224 | 86876203769 |
| FG9G7600WHT | White | Sliding Lid with 2-Cup Scoop (fits FG261000 BRUTE® Container) | 80 | 86876203585 |
| FG9G7600WHT | White | Sliding Lid with 2-Cup Scoop (fits FG261088 BRUTE® Container) | 224 | 86876203585 |
| FG9G7700WHT | White | Sliding Lid with 3-Cup Scoop (fits FG262000 BRUTE® Container) | 80 | 86876203592 |

| PART NO. | Color | DESCRIPTION | PAGE | UPC |
|--------------|------------|--|------|-------------|
| FG9G7700WHT | White | Sliding Lid with 3-Cup Scoop (fits FG262088 BRUTE® Container) | 224 | 86876203592 |
| FG9G7800WHT | White | Sliding Lid with 4-Cup Scoop (fits FG263200 BRUTE® Container) | 80 | 86876203608 |
| FG9G7800WHT | White | Sliding Lid with 4-Cup Scoop (fits FG263288 BRUTE® Container) | 224 | 86876203608 |
| FG9G7900CHRM | Chrome | Mobile Rack for Shelf Ingredient Bins, 38" wide | 223 | 86876203776 |
| FG9G8000CHRM | Chrome | Mobile Rack for Shelf Ingredient Bins, 50" wide | 223 | 86876203783 |
| FG9G8200WHT | White | ½-Cup Measuring Scoop for FG9G6000 Shelf Ingredient Bin | 223 | 86876203868 |
| FG9G8200WHT | White | Measuring Scoop | 232 | 86876203868 |
| FG9M0100BLA | Black | Lobby Pro® Wet/Dry Cleaning Wand | 134 | 86876164596 |
| FG9P9000BEIG | Beige | Plaza® Jr. Container | 63 | 86876167030 |
| FG9P9000BLA | Black | Plaza® Jr. Container | 63 | 86876167047 |
| FG9P9000DGRN | Dark Green | Plaza® Jr. Container | 63 | 86876167023 |
| FG9P9100BLA | Black | Plaza® Jr. Container with Ash Tray Top | 63 | 86876167078 |
| FG9S0000YEL | Yellow | Pop-Up Safety Cone, 20" (50.8 cm) with Multilingual "Caution" Imprint and Wet Floor Symbol | 156 | 86876165951 |
| FG9S0100YEL | Yellow | Pop-Up Safety Cone, 30" (76.2 cm) with Multilingual "Caution" Imprint and Wet Floor Symbol | 156 | 86876165968 |
| FG9S0700YEL | Yellow | Folding Safety Cone with "Caution" Imprint, English, Spanish, French | 156 | 86876173345 |
| FG9S0725YEL | Yellow | Folding Safety Cone with International Wet Floor Symbol | 156 | 86876173352 |
| FG9S0925YEL | Yellow | Stable Safety Sign with International Wet Floor Symbol | 154 | 86876173321 |
| FG9S09DPYEL | Yellow | Stable Safety Sign with "Caution" Imprint, English, Spanish, French | 154 | 86876204643 |
| FG9S1100YEL | Yellow | Mobile Barrier | 157 | 86876166729 |
| FG9S1500YEL | Yellow | Site Safety Hanging Sign with "Closed for Cleaning" Imprint – English Only | 155 | 86876166590 |
| FG9S1600YEL | Yellow | Site Safety Hanging Sign with Multilingual "Closed for Cleaning" Imprint | 155 | 86876166606 |
| FG9S3000GRAY | Gray | BRUTE® Tote with Lid | 187 | 86876166156 |
| FG9S3000WHT | White | BRUTE® Tote with Lid | 187 | 86876166163 |
| FG9S3100GRAY | Gray | BRUTE® Tote with Lid | 187 | 86876166187 |
| FG9S3100WHT | White | BRUTE® Tote with Lid | 187 | 86876166194 |
| FG9T0000BLA | Black | Executive Protective Security Hood for Traditional Housekeeping Carts | 144 | 86876192490 |
| FG9T0000PLAT | Platinum | Executive Protective Security Hood for Traditional Housekeeping Carts | 144 | 86876164763 |
| FG9T1300BLA | Black | Structural Foam Tilt Truck, Utility-Duty | 164 | 86876184167 |
| FG9T1400BLA | Black | Structural Foam Tilt Truck, Standard-Duty | 164 | 86876184174 |
| FG9T1500BLA | Black | Structural Foam Tilt Truck, Standard-Duty | 164 | 86876184204 |
| FG9T1600BLA | Black | Structural Foam Tilt Truck, Heavy-Duty | 164 | 86876184211 |
| FG9T1700BLA | Black | Tilt Truck (RM) | 165 | 86876165593 |
| FG9T1800BLA | Black | Tilt Truck | 165 | 86876165609 |
| FG9T1900BLA | Black | Executive Full-Size Housekeeping Cart with Doors and Hood - Traditional | 140 | 86876192445 |
| FG9T2200BLA | Black | Lid for 1/2-Cubic-Yard Tilt Trucks | 165 | 86876184228 |
| FG9T2300BLA | Black | Lid for 1-Cubic-Yard Tilt Trucks | 164 | 86876184242 |

| PART NO. | Color | DESCRIPTION | PAGE | UPC |
|--------------|--------|--|------|-------------|
| FG9T4500 | Black | StockMate® ES Restocking Truck with Hinged Deck | 220 | |
| FG9T4800 | Black | StockMate® Restocking Truck, Standard Deck | 220 | |
| FG9T5000 | Black | StockMate® Restocking Truck, Standard Deck with Cardboard Management System, Polyurethane Wheels and Casters | 220 | |
| FG9T5200 | Black | StockMate® Restocking Truck, Utility Deck, Olefin Wheels and Casters | 220 | |
| FG9T6571BEIG | Beige | Utility Cart with 3" dia (7.6 cm) Swivel Casters | 177 | |
| FG9T6600BLA | Black | Flat Handle Utility Cart (Small) with 5" Casters | 173 | |
| FG9T6700BLA | Black | Flat Handle Utility Cart (Med) with 5" Casters | 173 | |
| FG9T6800BLA | Black | Executive Service Cart | 176 | 86876200447 |
| FG9T6800BLA | Black | Executive Service Cart | 313 | 86876200447 |
| FG9T7200BLA | Black | Janitorial Cleaning Cart – High-Capacity | 139 | 86876180572 |
| FG9T7300BLA | Black | Janitorial Cleaning Cart w/Bins – High-Capacity | 182 | 86876180589 |
| FG9T73010000 | | Lock 'N Go Accessory | 182 | |
| FG9T73010000 | | Lock 'N Go Accessory | 138 | 86876188363 |
| FG9T73010000 | | Lock 'N Go Accessory | 139 | 86876188363 |
| FG9T7400BLA | Black | Janitorial Cleaning Cart Full Swivel w/Bins – High-Capacity | 138 | |
| FG9T7500BLA | Black | Janitorial Cleaning Cart – High-Security | 138 | 86876180602 |
| FG9T7800BLA | Black | Executive Housekeeping Compact Cart – High-Security | 142 | 86876180633 |
| FG9T8200BLA | Black | Executive 10-Quart Heavy-Duty Caddy | 140 | 86876180671 |
| FG9T8200YEL | Yellow | 10-Quart Heavy-Duty Caddy | 140 | |
| FG9T8400YEL | Yellow | 30-Quart Organizing Bins – Yellow | 140 | 86876180695 |
| FG9T8600BLA | Black | Executive Preassembled Locking Security Hood | 140 | 86876180718 |
| FG9T89010000 | | Executive Triple Waste Wire Bag Divider | 140 | 86876186321 |
| FG9T9000BLA | Black | Executive 9-Pocket Fabric Hanging Organizer Cart Caddy | 144 | 86876182101 |
| FG9T9200BLA | Black | Janitorial Cleaning and Recycling Triple Capacity Cart – High-Capacity | 184 | 86876187946 |
| FG9W0000BLA | Black | Landmark Series® Standard Funnel Top | 61 | 86876166880 |
| FG9W0100BLA | Black | Landmark Series® Standard Dome Top | 61 | 86876166897 |
| FG9W0200BLA | Black | Landmark Series® Funnel Top with Panel Frame and FG395800 Rigid Liner | 61 | 86876166903 |
| FG9W0300BLA | Black | Landmark Series® Dome Top with Panel Frame and FG395800 Rigid Liner | 61 | 86876166910 |
| FG9W0400BLA | Black | Window Wash Kit for FG9W0000, FG9W0100, FG9W0200, FG9W0300 Containers | 61 | 86876166927 |
| FG9W1088GRAY | Gray | BRUTE® Confidential Document Rollout Container | 19 | 86876168778 |
| FG9W1188GRAY | Gray | BRUTE® Confidential Document Rollout Container | 19 | |
| FG9W1600L | Gray | Slim Jim® Confidential Document Lid | 26 | |
| FG9W2100GRAY | Gray | BRUTE® Rollout Container with Lid | 17 | 86876168792 |
| FG9W2173BLUE | Blue | BRUTE® Rollout Container with Lid | 17 | 86876194326 |
| FG9W2200GRAY | Gray | BRUTE® Rollout Container with Lid | 17 | 86876169058 |
| FG9W2273BLUE | Blue | BRUTE® Rollout Container with Lid | 17 | 86876194333 |

UTILITY AND RECYCLING REFUSE

DECORATIVE REFUSE

CLEANING

MATERIAL HANDLING

WASHROOM

FOODSERVICE

ACCESSORIES & INDEX



| PART NO. | Color | DESCRIPTION | PAGE | UPC |
|----------------|---------------------------|--|------|-------------|
| FG9W2700BLUE | Blue | BRUTE® Rollout Container with Lid | 17 | 86876176636 |
| FG9W2700GRAY | Gray | BRUTE® Rollout Container with Lid | 17 | 86876175387 |
| FG9W2700YEL | Yellow | BRUTE® Rollout Container with Lid | 17 | 86876176643 |
| FG9W2773BLUE | Blue | BRUTE® Recycling Rollout Container with Lid | 19 | 86876194340 |
| FG9W29000000 | | Security Kit for GroundsKeeper® Tuscan Receptacle | 66 | |
| FG9W3000BLA | Black | GroundsKeeper® Tuscan Receptacle | 66 | 86876173055 |
| FG9W3000SSTON | Sandstone | GroundsKeeper® Tuscan Receptacle | 66 | 86876173048 |
| FG9W3100SSBLA | Stainless Steel/Black Top | Infinity™ Base-Mount Smoking Receptacle | 67 | 86876183450 |
| FG9W3200SSBLA | Stainless Steel/Black Top | Infinity™ Wall-Mount Smoking Receptacle | 67 | 86876183467 |
| FG9W3300AGBRNZ | Aged Bronze | Infinity™ Traditional Smoking Receptacle | 67 | 86876183481 |
| FG9W3300ATPWTR | Antique Pewter | Infinity™ Traditional Smoking Receptacle | 67 | |
| FG9W3300BLA | Black | Infinity™ Traditional Smoking Receptacle | 67 | 86876183474 |
| FG9W3400AGBRNZ | Aged Bronze | Infinity™ Ultra-High-Capacity Smoking Receptacle | 67 | 86876183511 |
| FG9W3400ATPWTR | Antique Pewter | Infinity™ Ultra-High-Capacity Smoking Receptacle | 67 | 86876183528 |
| FG9W3400BLA | Black | Infinity™ Ultra-High-Capacity Smoking Receptacle | 67 | 86876183504 |
| FG9W7300BLA | Black | Executive Mega BRUTE® Mobile Collector – 1-Pack | 79 | 86876182644 |
| FG9W7200BLA | Black | Executive Mega BRUTE® Mobile Collector Lid | 79 | 86876182651 |
| FG9W8700YEL | Yellow | BRUTE® Rim Caddy for 44-Gallon Containers | 15 | 86876172539 |
| FGA11106BL00 | Blue | Web Foot® Wet Mop | 104 | 86876090185 |
| FGA11106WH00 | White | Web Foot® Wet Mop | 104 | 86876090161 |
| FGA11206BL00 | Blue | Web Foot® Wet Mop | 104 | 86876090451 |
| FGA11206GR00 | Green | Web Foot® Wet Mop | 104 | 86876090444 |
| FGA11206OR00 | Orange | Web Foot® Wet Mop | 104 | 86876090468 |
| FGA11206WH00 | White | Web Foot® Wet Mop | 104 | 86876090437 |
| FGA11306BL00 | Blue | Web Foot® Wet Mop | 104 | 86876090710 |
| FGA11306GR00 | Green | Web Foot® Wet Mop | 104 | 86876090703 |
| FGA11306OR00 | Orange | Web Foot® Wet Mop | 104 | 86876090727 |
| FGA11306WH00 | White | Web Foot® Wet Mop | 104 | 86876090697 |
| FGA15106BL00 | Blue | Web Foot® Wet Mop | 104 | 86876091274 |
| FGA15106GR00 | Green | Web Foot® Wet Mop | 104 | 86876091267 |
| FGA15106WH00 | White | Web Foot® Wet Mop | 104 | 86876091250 |
| FGA15206BL00 | Blue | Web Foot® Wet Mop | 104 | 86876091557 |
| FGA15206GR00 | Green | Web Foot® Wet Mop | 104 | 86876091540 |
| FGA15206OR00 | Orange | Web Foot® Wet Mop | 104 | 86876091564 |
| FGA15206WH00 | White | Web Foot® Wet Mop | 104 | 86876091533 |
| FGA15306BL00 | Blue | Web Foot® Wet Mop | 104 | 86876091830 |
| FGA15306GR00 | Green | Web Foot® Wet Mop | 104 | 86876145168 |
| FGA15306OR00 | Orange | Web Foot® Wet Mop | 104 | 86876091847 |
| FGA15306WH00 | White | Web Foot® Wet Mop | 104 | 86876091816 |
| FGA21106BL00 | Blue | Web Foot® Shrinkless® Wet Mop | 104 | 86876092356 |
| FGA21106GR00 | Green | Web Foot® Shrinkless® Wet Mop | 104 | 86876092349 |
| FGA21106WH00 | White | Web Foot® Shrinkless® Wet Mop | 104 | 86876055238 |
| FGA21206BL00 | Blue | Web Foot® Shrinkless® Wet Mop | 104 | 86876092516 |
| FGA21206GR00 | Green | Web Foot® Shrinkless® Wet Mop | 104 | 86876055429 |
| FGA21206WH00 | White | Web Foot® Shrinkless® Wet Mop | 104 | 86876055252 |

| PART NO. | Color | DESCRIPTION | PAGE | UPC |
|--------------|----------------|---------------------------------|------|-------------|
| FGA21306BL00 | Blue | Web Foot® Shrinkless® Wet Mop | 104 | 86876092660 |
| FGA21306GR00 | Green | Web Foot® Shrinkless® Wet Mop | 104 | 86876145175 |
| FGA21306WH00 | White | Web Foot® Shrinkless® Wet Mop | 104 | 86876055276 |
| FGA25106BL00 | Blue | Web Foot® Shrinkless® Wet Mop | 104 | 86876092998 |
| FGA25106GR00 | Green | Web Foot® Shrinkless® Wet Mop | 104 | 86876092981 |
| FGA25106OR00 | Orange | Web Foot® Shrinkless® Wet Mop | 104 | 86876145182 |
| FGA25106WH00 | White | Web Foot® Shrinkless® Wet Mop | 104 | 86876092974 |
| FGA25206BL00 | Blue | Web Foot® Shrinkless® Wet Mop | 104 | 86876093148 |
| FGA25206GR00 | Green | Web Foot® Shrinkless® Wet Mop | 104 | 86876093131 |
| FGA25206OR00 | Orange | Web Foot® Shrinkless® Wet Mop | 104 | 86876093155 |
| FGA25206WH00 | White | Web Foot® Shrinkless® Wet Mop | 104 | 86876093124 |
| FGA25306BL00 | Blue | Web Foot® Shrinkless® Wet Mop | 104 | 86876093254 |
| FGA25306GR00 | Green | Web Foot® Shrinkless® Wet Mop | 104 | 86876093247 |
| FGA25306OR00 | Orange | Web Foot® Shrinkless® Wet Mop | 104 | 86876145199 |
| FGA25306WH00 | White | Web Foot® Shrinkless® Wet Mop | 104 | 86876055344 |
| FGA41206WH00 | White | Web Foot® Finish Mop | 105 | 86876093490 |
| FGA41306WH00 | White | Web Foot® Finish Mop | 105 | 86876093506 |
| FGAB1 | | Anchoring Bolt | 70 | |
| FGAOT15BKPL | Black Gloss | Open Top 56L/15G | 53 | 97591018736 |
| FGAOT15SAPL | Satin Aluminum | Open Top 56L/15G | 53 | 97591018934 |
| FGAOT30BKPL | Textured Black | Open Top 113L/30G | 53 | 97591043950 |
| FGAOT35SA | Satin Aluminum | Open Top 132L/35G | 55 | 97591002124 |
| FGAOT35SAGL | Satin Aluminum | Open Top 79L/21G | 55 | 97591041758 |
| FGAOT35SAPL | Satin Aluminum | Open Top 79L/21G | 55 | 97591041802 |
| FGAOT62SA | Satin Aluminum | Open Top 234L/62G | 55 | 97591018002 |
| FGAOT62SAPL | Satin Aluminum | Open Top 208L/55G | 55 | 97591041970 |
| FGA81206 | Green | Web Foot® Microfiber String Mop | 103 | |
| FGA85206 | Green | Web Foot® Microfiber String Mop | 103 | |
| FGA85306 | Green | Web Foot® Microfiber String Mop | 103 | |
| FGA81306 | Green | Web Foot® Microfiber String Mop | 103 | |
| FGB25 | | Black Sand, Five 5-Lb Bags | 70 | |
| FGBBT1529BK | Black | Fits FGWB44, FGWB2029 | 42 | 97591030301 |
| FGBBT1529GR | Green | Fits FGWB44, FGWB2031 | 42 | 97591029800 |
| FGBP1 | | Label "Biohazard" | 56 | |
| FGC11106WH00 | White | Swinger Loop® Wet Mop | 105 | 86876057676 |
| FGC11206BL00 | Blue | Swinger Loop® Wet Mop | 105 | 86876057935 |
| FGC11206GR00 | Green | Swinger Loop® Wet Mop | 105 | 86876057928 |
| FGC11206WH00 | White | Swinger Loop® Wet Mop | 105 | 86876057911 |
| FGC11306BL00 | Blue | Swinger Loop® Wet Mop | 105 | 86876058178 |
| FGC11306GR00 | Green | Swinger Loop® Wet Mop | 105 | 86876058161 |
| FGC11306WH00 | White | Swinger Loop® Wet Mop | 105 | 86876058154 |
| FGC11406WH00 | White | Swinger Loop® Wet Mop | 105 | 86876058390 |
| FGC15106BL00 | Blue | Swinger Loop® Wet Mop | 105 | 86876058659 |
| FGC15106GR00 | Green | Swinger Loop® Wet Mop | 105 | 86876058642 |
| FGC15206BL00 | Blue | Swinger Loop® Wet Mop | 105 | 86876058895 |
| FGC15206GR00 | Green | Swinger Loop® Wet Mop | 105 | 86876058888 |
| FGC15206WH00 | White | Swinger Loop® Wet Mop | 105 | 86876145212 |

| PART NO. | Color | DESCRIPTION | PAGE | UPC |
|--------------|-----------------|--|------|-------------|
| FGC15306BL00 | Blue | Swinger Loop® Wet Mop | 105 | 86876059137 |
| FGC15306GR00 | Green | Swinger Loop® Wet Mop | 105 | 86876059120 |
| FGC15306WH00 | White | Swinger Loop® Wet Mop | 105 | 86876059113 |
| FGC15406BL00 | Blue | Swinger Loop® Wet Mop | 105 | 86876059373 |
| FGC15406WH00 | White | Swinger Loop® Wet Mop | 105 | 86876059359 |
| FGC21206BL00 | Blue | Swinger Loop® Shrinkless® Wet Mop | 105 | 86876059854 |
| FGC21206GR00 | Green | Swinger Loop® Shrinkless® Wet Mop | 105 | 86876059847 |
| FGC21306BL00 | Blue | Swinger Loop® Shrinkless® Wet Mop | 105 | 86876060096 |
| FGC21306GR00 | Green | Swinger Loop® Shrinkless® Wet Mop | 105 | 86876060089 |
| FGC21306WH00 | White | Swinger Loop® Shrinkless® Wet Mop | 105 | 86876060072 |
| FGC25206BL00 | Blue | Swinger Loop® Shrinkless® Wet Mop | 105 | 86876060812 |
| FGC25206GR00 | Green | Swinger Loop® Shrinkless® Wet Mop | 105 | 86876060805 |
| FGC25206WH00 | White | Swinger Loop® Shrinkless® Wet Mop | 105 | 86876060799 |
| FGC25306BL00 | Blue | Swinger Loop® Shrinkless® Wet Mop | 105 | 86876061055 |
| FGC25306GR00 | Green | Swinger Loop® Shrinkless® Wet Mop | 105 | 86876061048 |
| FGC25306OR00 | Orange | Swinger Loop® Shrinkless® Wet Mop | 105 | 86876171518 |
| FGC25306WH00 | White | Swinger Loop® Shrinkless® Wet Mop | 105 | 86876061031 |
| FGC25406WH00 | White | Swinger Loop® Shrinkless® Wet Mop | 105 | 86876061277 |
| FGC41206WH00 | White | Swinger Loop® Finish Mop | 107 | 86876061529 |
| FGC41306WH00 | White | Swinger Loop® Finish Mop | 107 | 86876145250 |
| FGCC16SSSGL | Stainless Steel | Open Top 56L/15G | 54 | 97591010570 |
| FGCL1 | | English/Spanish Label "Biohazard" | 52 | |
| FGCL2 | | English/Spanish Label "Soiled Linen" | 52 | |
| FGCL3 | | English/Spanish Label "Trash Only" | 52 | |
| FGCL4 | | English/Spanish Label "Infectious Waste" | 52 | |
| FGD11306WH00 | White | Super Stitch® Cotton Looped-End Wet Mop | 108 | 86876064094 |
| FGD21106BL00 | Blue | Super Stitch® Blend Mop | 109 | 86876064391 |
| FGD21106WH00 | White | Super Stitch® Blend Mop | 109 | 86876064377 |
| FGD21206BL00 | Blue | Super Stitch® Blend Mop | 109 | 86876064599 |
| FGD21206GR00 | Green | Super Stitch® Blend Mop | 109 | 86876064582 |
| FGD21206RD00 | Red | Super Stitch® Blend Mop | 109 | 86876155013 |
| FGD21206WH00 | White | Super Stitch® Blend Mop | 109 | 86876064575 |
| FGD21306BL00 | Blue | Super Stitch® Blend Mop | 109 | 86876064797 |
| FGD21306GR00 | Green | Super Stitch® Blend Mop | 109 | 86876064780 |
| FGD21306RD00 | Red | Super Stitch® Blend Mop | 109 | 86876155020 |
| FGD21306WH00 | White | Super Stitch® Blend Mop | 109 | 86876064773 |
| FGD21406WH00 | White | Super Stitch® Blend Mop | 109 | 86876171532 |
| FGD25106BL00 | Blue | Super Stitch® Blend Mop | 109 | 86876065190 |
| FGD25106WH00 | White | Super Stitch® Blend Mop | 109 | 86876065176 |
| FGD25206BL00 | Blue | Super Stitch® Blend Mop | 109 | 86876065398 |
| FGD25206GR00 | Green | Super Stitch® Blend Mop | 109 | 86876065381 |
| FGD25206RD00 | Red | Super Stitch® Blend Mop | 109 | 86876155037 |
| FGD25206WH00 | White | Super Stitch® Blend Mop | 109 | 86876065374 |
| FGD25306BL00 | Blue | Super Stitch® Blend Mop | 109 | 86876065596 |
| FGD25306GR00 | Green | Super Stitch® Blend Mop | 109 | 86876065589 |
| FGD25306RD00 | Red | Super Stitch® Blend Mop | 109 | 86876155044 |
| FGD25306WH00 | White | Super Stitch® Blend Mop | 109 | 86876065572 |
| FGD25406WH00 | White | Super Stitch® Blend Mop | 109 | 86876171549 |
| FGD41206WH00 | White | Super Stitch® Rayon Mop | 107 | 86876065978 |
| FGD41306WH00 | White | Super Stitch® Rayon Mop | 107 | 86876066012 |
| FGD45306WH00 | White | Super Stitch® Rayon Mop | 107 | 86876167283 |
| FGD51206WH00 | White | Super Stitch® Finish Mop | 107 | 86876154825 |
| FGD51306WH00 | White | Super Stitch® Finish Mop | 107 | 86876154832 |

| PART NO. | Color | DESCRIPTION | PAGE | UPC |
|--------------|--------------------------|--|------|-------------|
| FGD55206WH00 | White | Super Stitch® Finish Mop | 107 | 86876154931 |
| FGD55306WH00 | White | Super Stitch® Finish Mop | 107 | 86876154948 |
| FGDCR24CSM | Stardust Silver Metallic | Square Recycle with Bottle/Cans Lid/Label 109L/29G | 14 | 97591128657 |
| FGDCR24TSM | Stardust Silver Metallic | Square Recycle with Trash Lid/Label 109L/29G | 14 | 97591128671 |
| FGE05200WH00 | White | Finish Mop, Looped Fringe | 90 | 86876118339 |
| FGE13600WH00 | White | Universal Headband Cotton Mop | 110 | 86876050103 |
| FGE13800WH00 | White | Universal Headband Cotton Mop | 110 | 86876047813 |
| FGE13900WH00 | White | Universal Headband Cotton Mop | 110 | 86876047790 |
| FGE23600BL00 | Blue | Universal Headband Blue Blend Mop | 109 | 86876050141 |
| FGE23800BL00 | Blue | Universal Headband Blue Blend Mop | 109 | 86876050165 |
| FGE23900BL00 | Blue | Universal Headband Blue Blend Mop | 109 | 86876050172 |
| FGE43600WH00 | White | Universal Headband Rayon Mop | 109 | 86876050196 |
| FGE43800WH00 | White | Universal Headband Rayon Mop | 109 | 86876050219 |
| FGF11600WH00 | White | Premium Cut-End Cotton Mop | 111 | 86876050240 |
| FGF11700WH00 | White | Premium Cut-End Cotton Mop | 111 | 86876045925 |
| FGF11800WH00 | White | Premium Cut-End Cotton Mop | 111 | 86876044713 |
| FGF11900WH00 | White | Premium Cut-End Cotton Mop | 111 | 86876046038 |
| FGF13100BL00 | Blue | Synthetic Blend Mop | 113 | 86876116304 |
| FGF13100GR00 | Green | Synthetic Blend Mop | 113 | 86876116311 |
| FGF13100PINK | Pink | Synthetic Blend Mop | 113 | 86876116328 |
| FGF13200BL00 | Blue | Synthetic Blend Mop | 113 | 86876116342 |
| FGF13200GR00 | Green | Synthetic Blend Mop | 113 | 86876116359 |
| FGF13600BL00 | Blue | Synthetic Blend Mop | 113 | 86876116427 |
| FGF13600GR00 | Green | Synthetic Blend Mop | 113 | 86876116434 |
| FGF13700BL00 | Blue | Synthetic Blend Mop | 113 | 86876116465 |
| FGF13700GR00 | Green | Synthetic Blend Mop | 113 | 86876116472 |
| FGF13700PINK | Pink | Synthetic Blend Mop | 113 | 86876116489 |
| FGF15600WH00 | White | Premium Cut-End Cotton Mop | 111 | 86876050264 |
| FGF15700WH00 | White | Premium Cut-End Cotton Mop | 111 | 86876050271 |
| FGF15800WH00 | White | Premium Cut-End Cotton Mop | 111 | 86876046045 |
| FGF15900WH00 | White | Premium Cut-End Cotton Mop | 111 | 86876067385 |
| FGF21600WH00 | White | Premium Cut-End Cotton Mop | 111 | |
| FGF16600WH00 | White | Premium Bolt-On Cut-End Cotton Mop | 113 | 86876046052 |
| FGF16700WH00 | White | Premium Bolt-On Cut-End Cotton Mop | 113 | 86876067477 |
| FGF16800WH00 | White | Premium Bolt-On Cut-End Cotton Mop | 113 | 86876046069 |
| FGF21700WH00 | White | Premium 8-Ply Cut-End Cotton Mop | 113 | 86876067927 |
| FGF21800WH00 | White | Premium 8-Ply Cut-End Cotton Mop | 113 | 86876067958 |
| FGF21900WH00 | White | Premium 8-Ply Cut-End Cotton Mop | 113 | 86876067989 |
| FGF41600WH00 | White | Premium Cut-End Rayon Mop | 110 | 86876068948 |
| FGF41700WH00 | White | Premium Cut-End Rayon Mop | 110 | 86876045949 |
| FGF41800WH00 | White | Premium Cut-End Rayon Mop | 110 | 86876044720 |
| FGF46700WH00 | White | Premium Bolt-On Cut-End Rayon Mop | 112 | 86876069273 |
| FGF46800WH00 | White | Premium Bolt-On Cut-End Rayon Mop | 112 | 86876069303 |
| FGF51600BL00 | Blue | Premium Cut-End Blend Mop | 110 | 86876049145 |
| FGF51700BL00 | Blue | Premium Cut-End Blend Mop | 110 | 86876049152 |
| FGF51700WH00 | White | Premium Cut-End Blend Mop | 110 | 86876045932 |
| FGF51800BL00 | Blue | Premium Cut-End Blend Mop | 110 | 86876049169 |
| FGF51800WH00 | White | Premium Cut-End Blend Mop | 110 | 86876045857 |
| FGF51900BL00 | Blue | Premium Cut-End Blend Mop | 110 | 86876049121 |
| FGF55600BL00 | Blue | Premium Cut-End Blend Mop | 110 | 86876070408 |
| FGF55700BL00 | Blue | Premium Cut-End Blend Mop | 110 | 86876070521 |
| FGF55800BL00 | Blue | Premium Cut-End Blend Mop | 110 | 86876070644 |
| FGF56600BL00 | Blue | Premium Bolt-On Cut-End Blend Mop | 112 | 86876071009 |

UTILITY AND RECYCLING REFUSE

DECORATIVE REFUSE

CLEANING

MATERIAL HANDLING

WASHROOM

FOODSERVICE

ACCESSORIES & INDEX



| PART NO. | Color | DESCRIPTION | PAGE | UPC |
|--------------|-------|---|------|-------------|
| FGF56700BL00 | Blue | Premium Bolt-On Cut-End Blend Mop | 112 | 86876064537 |
| FGF56800BL00 | Blue | Premium Bolt-On Cut-End Blend Mop | 112 | 86876066043 |
| FGF55900 | Blue | Premium Cut-End Blend Mop | 110 | |
| FGG78004 | | PVA Sponge Mop | 117 | 41301112146 |
| FGG78112 | | PVA Sponge Mop Refill | 117 | 41301112153 |
| FGGO4300WH00 | White | Replacement Mop Head for FGGO4204 | 117 | |
| FGH115000000 | | Invader® Side-Gate Wet Mop Handle, Large Yellow Plastic Head, Hardwood Handle | 115 | 86876045444 |
| FGH116000000 | | Invader® Side-Gate Wet Mop Handle, Large Yellow Plastic Head, Hardwood Handle | 115 | 86876045956 |
| FGH124000000 | | User-Friendly Mop Handle with Side-Gate Head | 116 | 86876159417 |
| FGH125000000 | | Invader® Side-Gate Wet Mop Handle, Large Yellow Plastic Head, Gray Aluminum Handle | 115 | 86876050394 |
| FGH126000000 | | Invader® Side-Gate Wet Mop Handle, Large Yellow Plastic Head, Gray Aluminum Handle | 115 | 86876050400 |
| FGH12IGC | Cedar | In-Ground Post w/ Lumber-Finished Slats 128L/34G | 59 | 97591049488 |
| FGH12SMC | Cedar | Surface Post w/ Lumber-Finished Slats 128L/34G | 59 | 97591042885 |
| FGH135000000 | | Invader® Side-Gate Wet Mop Handle, Large Yellow Plastic Head, Vinyl-Covered Aluminum Handle | 115 | 86876047912 |
| FGH136000000 | | Invader® Side-Gate Wet Mop Handle, Large Yellow Plastic Head, Vinyl-Covered Aluminum Handle | 115 | 86876046168 |
| FGH145000000 | | Invader® Side-Gate Wet Mop Handle, Large Yellow Plastic Head, Fiberglass Handle | 115 | 86876052459 |
| FGH14600BL00 | Blue | Invader® Side-Gate Wet Mop Handle, Large Yellow Plastic Head, Fiberglass Handle | 115 | 86876146899 |
| FGH14600GR00 | Green | Invader® Side-Gate Wet Mop Handle, Large Yellow Plastic Head, Fiberglass Handle | 115 | 86876146875 |
| FGH14600GY00 | Gray | Invader® Side-Gate Wet Mop Handle, Large Yellow Plastic Head, Fiberglass Handle | 115 | 86876147353 |
| FGH14600RD00 | Red | Invader® Side-Gate Wet Mop Handle, Large Yellow Plastic Head, Fiberglass Handle | 115 | 86876146882 |
| FGH215000000 | | Gripper® Clamp-Style Wet Mop Handle, Plastic Yellow Head, Hardwood Handle | 115 | 86876045451 |
| FGH216000000 | | Gripper® Clamp-Style Wet Mop Handle, Plastic Yellow Head, Hardwood Handle | 115 | 86876046137 |
| FGH225000000 | | Gripper® Clamp-Style Wet Mop Handle, Plastic Yellow Head, Gray Aluminum Handle | 115 | 86876050448 |
| FGH226000000 | | Gripper® Clamp-Style Wet Mop Handle, Plastic Yellow Head, Gray Aluminum Handle | 115 | 86876046120 |
| FGH236000000 | | Gripper® Clamp-Style Wet Mop Handle, Plastic Yellow Head, Vinyl-Coated Aluminum Handle | 115 | 86876050462 |
| FGH245000000 | | Gripper® Clamp-Style Wet Mop Handle, Plastic Yellow Head, Fiberglass Handle | 115 | 86876052473 |
| FGH24600BL00 | Blue | Gripper® Clamp-Style Wet Mop Handle, Plastic Yellow Head, Fiberglass Handle | 115 | 86876146929 |
| FGH24600GR00 | Green | Gripper® Clamp-Style Wet Mop Handle, Plastic Yellow Head, Fiberglass Handle | 115 | 86876146905 |

| PART NO. | Color | DESCRIPTION | PAGE | UPC |
|--------------|--------|---|------|-------------|
| FGH24600GY00 | Gray | Gripper® Clamp-Style Wet Mop Handle, Plastic Yellow Head, Fiberglass Handle | 115 | 86876147360 |
| FGH24600RD00 | Red | Gripper® Clamp-Style Wet Mop Handle, Plastic Yellow Head, Fiberglass Handle | 115 | 86876146912 |
| FGH516000000 | | Easy-Change Wet Mop Handle, Large Steel Head, Wood Handle | 115 | 86876053647 |
| FGJ15100YL00 | Yellow | Trapper® Dust Mop | 121 | 86876093698 |
| FGJ15200YL00 | Yellow | Trapper® Dust Mop | 121 | 86876093810 |
| FGJ15300YL00 | Yellow | Trapper® Dust Mop | 121 | 86876093933 |
| FGJ15500YL00 | Yellow | Trapper® Dust Mop | 121 | 86876094176 |
| FGJ15700YL00 | Yellow | Trapper® Dust Mop | 121 | 86876094411 |
| FGJ15800YL00 | Yellow | Trapper® Dust Mop | 121 | 86876171587 |
| FGJ25200BL00 | Blue | Twisted-Loop Blend Dust Mop | 120 | 86876182170 |
| FGJ25300BL00 | Blue | Twisted-Loop Blend Dust Mop | 120 | 86876182194 |
| FGJ25500BL00 | Blue | Twisted-Loop Blend Dust Mop | 120 | 86876182217 |
| FGJ25700BL00 | Blue | Twisted-Loop Blend Dust Mop | 120 | 86876182231 |
| FGJ35200BL00 | Blue | Twisted-Loop Synthetic Dust Mop | 120 | 86876182323 |
| FGJ35300BL00 | Blue | Twisted-Loop Synthetic Dust Mop | 120 | 86876182330 |
| FGJ35500BL00 | Blue | Twisted-Loop Synthetic Dust Mop | 120 | 86876182347 |
| FGJ35700BL00 | Blue | Twisted-Loop Synthetic Dust Mop | 120 | 86876182354 |
| FGJ35800BL00 | Blue | Twisted-Loop Synthetic Dust Mop | 120 | 86876182361 |
| FGJ55300GR00 | Green | Twisted-Loop Blend Antimicrobial Dust Mop | 120 | 86876182286 |
| FGJ55500GR00 | Green | Twisted-Loop Blend Antimicrobial Dust Mop | 120 | 86876182293 |
| FGJ55700GR00 | Green | Twisted-Loop Blend Antimicrobial Dust Mop | 120 | 86876182309 |
| FGJ85200GR00 | Green | Microfiber Loop Dust Mop 18" | 119 | 86876194579 |
| FGJ85300GR00 | Green | Microfiber Loop Dust Mop 24" | 119 | 86876194586 |
| FGJ85500GR00 | Green | Microfiber Loop Dust Mop 36" | 119 | 86876194593 |
| FGJ85700GR00 | Green | Microfiber Loop Dust Mop 48" | 119 | 86876194609 |
| FGJ85800GR00 | Green | Microfiber Loop Dust Mop 60" | 119 | 86876204063 |
| FGJ85900GR00 | Green | Microfiber Loop Dust Mop 72" | 119 | 86876204070 |
| FGK15200BL00 | Blue | Kut-A-Way® Dust Mop | 121 | 86876081336 |
| FGK15200WH00 | White | Kut-A-Way® Dust Mop | 121 | 86876049176 |
| FGK15300BL00 | Blue | Kut-A-Way® Dust Mop | 121 | 86876081855 |
| FGK15300WH00 | White | Kut-A-Way® Dust Mop | 121 | 86876045499 |
| FGK15500BL00 | Blue | Kut-A-Way® Dust Mop | 121 | 86876082913 |
| FGK15500WH00 | White | Kut-A-Way® Dust Mop | 121 | 86876050677 |
| FGK15700BL00 | Blue | Kut-A-Way® Dust Mop | 121 | 86876083958 |
| FGK15700WH00 | White | Kut-A-Way® Dust Mop | 121 | 86876050691 |
| FGK15800WH00 | White | Kut-A-Way® Dust Mop | 121 | 86876050707 |
| FGK15900WH00 | White | Kut-A-Way® Dust Mop | 121 | 86876050714 |
| FGK165S | | Compact Portion Control Scale | 235 | 77177025013 |
| FGK32 | | Oven-Run Scale with 1 pt Measuring Cup | 235 | 77177125034 |
| FGK75300WH00 | White | Twisted-Loop Cotton Dust Mop | 120 | 86876182132 |
| FGK75500WH00 | White | Twisted-Loop Cotton Dust Mop | 120 | 86876182149 |
| FGKF165S | | Compact Portion Control Scale with Contoured Platform | 235 | 77177125027 |
| FGKR12 | | Anchoring Kit | 70 | |
| FGKR52C | | Anchoring Kit (concrete) | 70 | |
| FGL15300GR00 | Green | Blended Cut-End Disposable Dust Mop | 121 | 86876087369 |
| FGL15300WH00 | White | Blended Cut-End Disposable Dust Mop | 121 | 86876045505 |
| FGL15500WH00 | White | Blended Cut-End Disposable Dust Mop | 121 | 86876087598 |
| FGL15700GR00 | Green | Blended Cut-End Disposable Dust Mop | 121 | 86876087840 |
| FGL15700WH00 | White | Blended Cut-End Disposable Dust Mop | 121 | 86876087833 |
| FGL15800WH00 | White | Blended Cut-End Disposable Dust Mop | 121 | 86876087956 |

| PART NO. | Color | DESCRIPTION | PAGE | UPC |
|--------------|----------------------|--|------|-------------|
| FGL15900WH00 | White | Blended Cut-End Disposable Dust Mop | 121 | 86876088076 |
| FGL25300WH00 | White | Cut-End Disposable Cotton Dust Mop | 122 | 86876051841 |
| FGL25500WH00 | White | Cut-End Disposable Cotton Dust Mop | 122 | 86876051865 |
| FGL25700WH00 | White | Cut-End Disposable Cotton Dust Mop | 122 | 86876051889 |
| FGM116000000 | | Snap-On Dust Mop Handle, Hardwood | 122 | 86876046182 |
| FGM136000000 | | Snap-On Dust Mop Handle, Vinyl-Covered, Hardwood | 122 | 86876052824 |
| FGM146000000 | | Snap-On Dust Mop Handle, Fiberglass | 122 | 86876052497 |
| FGM15000WH00 | White | Cut-to-Length Dust Mop | 123 | 86876144383 |
| FGM251000000 | | Snap-On Wire Dust Mop Frame | 122 | 86876089394 |
| FGM252000000 | | Snap-On Wire Dust Mop Frame | 122 | 86876089417 |
| FGM253000000 | | Snap-On Wire Dust Mop Frame | 122 | 86876046199 |
| FGM255000000 | | Snap-On Wire Dust Mop Frame | 122 | 86876089479 |
| FGM257000000 | | Snap-On Wire Dust Mop Frame | 122 | 86876089516 |
| FGM258000000 | | Snap-On Wire Dust Mop Frame | 122 | 86876089530 |
| FGM259000000 | | Snap-On Wire Dust Mop Frame | 122 | 86876089554 |
| FGMT22 | Architectural Bronze | Americana Series™ Open Top | 59 | |
| FGMT22 | Black | Americana Series™ Open Top | 59 | |
| FGMT32 | Architectural Bronze | Americana Series™ Open Top | 59 | |
| FGMT32 | Black | Americana Series™ Open Top | 59 | |
| FGMT32 | Green | Americana Series™ Open Top | 59 | |
| FGP100S | | Briefcase Receiving Scale | 236 | 86876208009 |
| FGP11700WH00 | White | Standard Thickness Bonnet | 125 | 86876089738 |
| FGP11900WH00 | White | Standard Thickness Bonnet | 125 | 86876089745 |
| FGP12100WH00 | White | Standard Thickness Bonnet | 125 | 86876089752 |
| FGP250S | | Briefcase Receiving Scale | 236 | 86876208023 |
| FGP250SS | | Briefcase Receiving Scale | 236 | 77177068621 |
| FGP26700WH00 | White | Low-Profile with Green Scrub Strips Bonnet | 125 | 86876095418 |
| FGP26900WH00 | White | Low-Profile with Green Scrub Strips Bonnet | 125 | 86876095425 |
| FGP27100WH00 | White | Low-Profile with Green Scrub Strips Bonnet | 125 | 86876120578 |
| FGHPIG | | Towne Series In-Ground Pole with Hardware | 38 | |
| FGQ050000000 | | Microfiber Finish System, Includes Bucket with Lid, Sieve, 8 Pads, 1 Frame | 90 | 86876204865 |
| FGQ11000BK00 | Black | 11" (27.9 cm) HYGEN™ Hook-and-Loop Replacement Set for FGQ55000 | 80 | 86876174885 |
| FGQ18000BK00 | Black | 17" (43.2 cm) HYGEN™ Hook-and-Loop Replacement Set for FGQ56000 | 80 | 86876174892 |
| FGQ24000BK00 | Black | 24" (61 cm) Hook-and-Loop Replacement Set for FGQ57000 | 80 | 86876174908 |
| FGQ25700WH00 | White | 17" Microfiber Carpet Bonnet | 125 | 86876201062 |
| FGQ25900WH00 | White | 19" Microfiber Carpet Bonnet | 125 | 86876201079 |
| FGQ36000BK00 | Black | 35" (88.9 cm) HYGEN™ Hook-and-Loop Replacement Set for FGQ58000 | 79 | 86876174915 |
| FGQ40800GR00 | Green | 18" (45.7 cm) Light Commercial Microfiber Fringed Dust Mop | 88 | |
| FGQ40900BL00 | Blue | 18" (45.7 cm) Light Commercial Microfiber Damp Mop | 88 | |
| FGQ41000BL00 | Blue | 18" (45.7 cm) HYGEN™ Microfiber Super Scrubber Mop | 79 | 86876170016 |

| PART NO. | Color | DESCRIPTION | PAGE | UPC |
|--------------|--------|--|------|-------------|
| FGQ41000GR00 | Green | 18" (45.7 cm) HYGEN™ Microfiber Super Scrubber Mop | 79 | 86876174052 |
| FGQ41000RD00 | Red | 18" (45.7 cm) HYGEN™ Microfiber Super Scrubber Mop | 79 | 86876174045 |
| FGQ41100BL00 | Blue | 24" (61 cm) HYGEN™ Microfiber Damp Room Mop | 79 | 86876173734 |
| FGQ41200GR00 | Green | 18" (45.7 cm) HYGEN™ Microfiber Room Dust Mop | 78 | 86876175448 |
| FGQ41200WH00 | White | 18" (45.7 cm) HYGEN™ Microfiber Room Dust Mop | 78 | 86876170023 |
| FGQ41500BL00 | Blue | 18" (45.7 cm) HYGEN™ Microfiber Damp Mop with Scrubber | 79 | 86876174946 |
| FGQ41600BL00 | Blue | 18" (45.7 cm) HYGEN™ Microfiber High-Absorbency Mop | 79 | 86876174960 |
| FGQ41800GR00 | Green | 18" (45.7 cm) HYGEN™ Microfiber Fringed Dust Mop | 78 | 86876174939 |
| FGQ42400GR00 | Green | 24" (61 cm) HYGEN™ Microfiber Hall Dust Mop | 78 | 86876170139 |
| FGQ42500BL00 | Blue | 24" (61 cm) HYGEN™ Microfiber Damp Mop with Scrubber | 79 | 86876174953 |
| FGQ42600GR00 | Green | 24" (61 cm) HYGEN™ Microfiber Fringed Dust Mop | 78 | 86876182484 |
| FGQ43600GR00 | Green | 36" (91.4 cm) HYGEN™ Microfiber Hall Dust Mop | 78 | 86876170047 |
| FGQ43800GR00 | Green | 36" (91.4 cm) HYGEN™ Microfiber Fringed Dust Mop | 78 | 86876182491 |
| FGQ44800GR00 | Green | 48" (121.9 cm) HYGEN™ Microfiber Hall Dust Mop | 78 | 86876170146 |
| FGQ44900GR00 | Green | 48" (121.9 cm) HYGEN™ Microfiber Fringed dust Mop | 78 | 86876182507 |
| FGQ46000GR00 | Green | 60" (152.4 cm) HYGEN™ Microfiber Fringed Dust Mop | 78 | 86876182514 |
| FGQ48000BK00 | Black | 47" (119.4 cm) HYGEN™ Hook-and-Loop Replacement Set for FGQ59000 | 80 | 86876174922 |
| FGQ55000YL00 | Yellow | 11" (27.9 cm) HYGEN™ Quick-Connect Wet/Dry Frame | 80 | 86876174823 |
| FGQ55900BK00 | Black | 18" (45.7 cm) Light and Commercial Quick-Connect Wet/Dry Plastic Frame | 85 | 86876186079 |
| FGQ56000YL00 | Yellow | 17" (43.2 cm) (45.7 cm) HYGEN™ Quick-Connect Wet/Dry Frame | 80 | 86876174830 |
| FGQ57000YL00 | Yellow | 24" (61 cm) HYGEN™ Quick-Connect Wet/Dry Frame with Squeegee | 80 | 86876174847 |
| FGQ58000YL00 | Yellow | 35" (88.9 cm) HYGEN™ Quick-Connect Hall Dusting Frame | 80 | 86876174854 |
| FGQ59000YL00 | Yellow | 47" (119.4 cm) HYGEN™ Quick-Connect Hall Dusting Frame | 80 | 86876174861 |
| FGQ59500YL00 | Yellow | 59" (149.9 cm) HYGEN™ Quick-Connect Hall Dusting Frame | 80 | 86876182477 |
| FGQ60000BK00 | Black | 59" (149.9 cm) HYGEN™ Hook-and-Loop Replacement Set for FGQ59500 | 80 | 86876186345 |
| FGQ61000YL00 | Yellow | HYGEN™ Microfiber Bathroom Cloth (Yellow) | 76 | 86876170085 |
| FGQ62000BL00 | Blue | HYGEN™ Microfiber General-Purpose Cloth (Blue) | 76 | 86876179088 |
| FGQ62000GR00 | Green | HYGEN™ Microfiber General-Purpose Cloth (Green) | 76 | 86876170092 |
| FGQ62000RD00 | Red | HYGEN™ Microfiber General-Purpose Cloth (Red) | 76 | 86876179101 |
| FGQ62006GR00 | Green | HYGEN™ Microfiber General-Purpose Cloth (Green) | 76 | 86876170092 |
| FGQ63000BL00 | Blue | HYGEN™ Microfiber Glass/Mirror Cloth (Blue) | 76 | 86876170108 |
| FGQ63006BL00 | Blue | HYGEN™ Microfiber Glass/Mirror Cloth (Blue) | 76 | 86876178616 |

UTILITY AND RECYCLING REFUSE

DECORATIVE REFUSE

CLEANING

MATERIAL HANDLING

WASHROOM

FOODSERVICE

ACCESSORIES & INDEX



| PART NO. | Color | DESCRIPTION | PAGE | UPC |
|--------------|-----------------|---|------|-------------|
| FGQ64000GR00 | Green | HYGEN™ Microfiber XL General-Purpose Cloth (Green) | 76 | 86876170115 |
| FGQ65000GR00 | Green | HYGEN™ Microfiber All-Purpose Mitt with Thumb | 86 | 86876173765 |
| FGQ65100BL00 | Blue | HYGEN™ Microfiber Glass/Mirror Mitt with Thumb | 86 | 86876173772 |
| FGQ65200GR00 | Green | HYGEN™ Microfiber Dusting Mitt with Thumb | 86 | 86876200966 |
| FGQ70100BK00 | Black | ACME to HYGEN™ Quick-Connect Adapter | 81 | 86876201000 |
| FGQ74500YL00 | Yellow | 20"–40" (50.8 cm–101.6 cm) HYGEN™ Quick-Connect Short Extension Handle | 81 | 86876182453 |
| FGQ74900YL00 | Yellow | 52" (132 cm) Light Commercial Quick-Connect Steel Handle | 88 | 86876186086 |
| FGQ75000YL00 | Yellow | 58" (147.3 cm) HYGEN™ Quick-Connect Handle | 81 | 86876174809 |
| FGQ75500YL00 | Yellow | 48"–72" (121.9 cm–182.9 cm) HYGEN™ Quick-Connect Ergo Adjustable Handle | 81 | 86876182460 |
| FGQ760000000 | | 48"–72" (121.9–182.9 cm) HYGEN™ Quick-Connect Ergo Adjustable Handle | 81 | 86876174816 |
| FGQ76500YL00 | Yellow | 4"–8" HYGEN™ Quick-Connect Extension Pole | 81 | 86876201017 |
| FGQ77000YL00 | Yellow | 6"–12" HYGEN™ Quick-Connect Extension Pole | 81 | 86876201024 |
| FGQ77500YL00 | Yellow | 6"–18" HYGEN™ Quick-Connect Extension Pole | 81 | 86876201116 |
| FGQ80000WH00 | White | 18" (45.7 cm) Microfiber Finish Pad | 90 | 86876173710 |
| FGQ80500WH00 | White | FLOW™ Nylon Flat Mop | 89 | 86876192377 |
| FGQ81000YL00 | Yellow | 18" (45.7 cm) HYGEN™ Microfiber Super Scrubber Mop | 79 | 86876173727 |
| FGQ82000BL00 | Blue | 11" (27.9 cm) HYGEN™ Microfiber Wall/Stair Damp Mop | 79 | 86876173741 |
| FGQ85000BK00 | Black | HYGEN™ Quick-Connect Flexible Dusting Wand with Microfiber Sleeve | 86 | 86876174977 |
| FGQ85100GR00 | Green | HYGEN™ Wand Duster Microfiber Replacement Sleeve | 86 | 86876174984 |
| FGQ85200WH00 | White | Executive 22" HYGEN™ Multipurpose Flexible Microfiber Duster and Frame | 86 | 86876200942 |
| FGQ85300WH00 | White | Executive 22" HYGEN™ Multipurpose Flexible Microfiber Duster | 86 | 86876200959 |
| FGQ85500BK00 | Black | 11" HYGEN™ Microfiber Flexi-Frame | 77 | 86876200898 |
| FGQ85600GR00 | Green | HYGEN™ Microfiber Flexi-Frame Duster Cover | 77 | 86876200904 |
| FGQ86100WH00 | White | 11" HYGEN™ Microfiber Flexi-Frame Hi-Pile Cover | 77 | 86876200911 |
| FGQ87100BL00 | Black | HYGEN™ Microfiber Flexi-Frame Glass Cover | 77 | 86876201109 |
| FGQ88100YL00 | Yellow | HYGEN™ Microfiber Flexi-Frame Tub and Tile Cover | 77 | 86876200928 |
| FGQ89100BL00 | Blue | HYGEN™ Microfiber Flexi-Frame Damp Mop Cover | 77 | 86876201789 |
| FGQ90088YEL | Yellow | HYGEN™ Press Wring Bucket | 82 | 86876176827 |
| FGQ93000BLUE | Blue | Finish Bucket | 90 | |
| FGQ95088YEL | Yellow | HYGEN™ Changing Bucket | 82 | 86876206418 |
| FGQ966000000 | | HYGEN™ PULSE™ Caddy | 83 | 86876192360 |
| FGQ966000000 | | Rubbermaid PULSE™ Caddy | 85 | 86876192360 |
| FGQ977000000 | | FLOW™ Replacement Bladder | 89 | 86876192391 |
| FGQ97900YL00 | Yellow | FLOW™ Flat Mop Finish Kit | 89 | 86876192346 |
| FGR1012EBK | Black | Smokers' Station® Wall-Mount Urn w/ Keyed Cam Lock | 65 | 97591027042 |
| FGR1012SS | Stainless Steel | Smokers' Station® Wall-Mount Urn w/ Keyed Cam Lock | 65 | 97591027004 |

| PART NO. | Color | DESCRIPTION | PAGE | UPC |
|----------------|--|---|------|-------------|
| FGR12SU201PL | Brown Gloss Trim w/ Brown Panels | Ash/Trash 45L/12G | 58 | 97591028575 |
| FGR1536EGLBK | Black Gloss | Push Door 56L/15G | 53 | 97591059418 |
| FGR1536EOTGLBK | Black Gloss | Dome Top 56L/15G | 40 | 97591107089 |
| FGR1536EOTPLBK | Black Gloss | Dome Top 56L/15G | 40 | 97591105351 |
| FGR1536EPLBK | Black Gloss | Push Door 56L/15G | 53 | 97591061763 |
| FGR1536MCGL | Mirror Chrome | Push Door 56L/15G | 53 | 97591058503 |
| FGR1536MCPL | Mirror Chrome | Push Door 56L/15G | 53 | 97591060858 |
| FGR1536SSSGL | Stainless Steel | Push Door 56L/15G | 53 | 97591011065 |
| FGR1536SSSPL | Stainless Steel | Push Door 56L/15G | 53 | 97591011157 |
| FGR1639EHBZ | Hammertone Bronze | Aladdin Smokers' Station® | 69 | |
| FGR1639EHGR | Hammertone Charcoal | Aladdin Smokers' Station® | 69 | |
| FGR18SU201PL | Brown Gloss Trim w/ Brown Panels | Ash/Trash 90L/24G | 58 | 97591065761 |
| FGR18WU500PL | Black Gloss w/ Anthracite Metallic Perf Panels | Ash/Trash Weather Shield 90L/24G | 58 | 97591107911 |
| FGR1BK | Black | Smokers' Pole | 69 | 97591109113 |
| FGR1SM | Silver Metallic | Smokers' Pole | 69 | 97591109106 |
| FGR2030EPLBK | Black Gloss | Eclipse Open Top Metal Refuse | 57 | 97591123928 |
| FGR2030SSPL | Stainless Steel | Eclipse Open Top Metal Refuse | 57 | 97591121856 |
| FGR32EGLBK | Black Gloss | Open Top 56L/15G | 27 | 97591055717 |
| FGR32EGLWH | Sky White Gloss | Open Top 56L/15G | 27 | 97591055663 |
| FGR32SSSGL | Stainless Steel | Open Top 56L/15G | 27 | 97591010990 |
| FGR36HT201PL | Brown Gloss Trim w/ Brown Panels | Hinged Top 109L/29G | 58 | 97591024607 |
| FGR36HT500PL | Black Gloss w/ Anthracite Metallic Perf Panels | Hinged Top 109L/29G | 58 | 97591106204 |
| FGR38HT201PL | Brown Gloss Trim w/ Brown Panels | Hinged Top 143L/38G | 58 | 97591025710 |
| FGR38HT500PL | Black Gloss w/ Anthracite Metallic Perf Panels | Hinged Top 143L/38G | 58 | 97591106242 |
| FGR48HT201PL | Brown Gloss Trim w/ Brown Panels | Hinged Top 181L/48G | 58 | 97591001288 |
| FGR48HT500PL | Black Gloss w/ Anthracite Metallic Perf Panels | Hinged Top 181L/48G | 58 | 97591106259 |
| FGR93400BK | Black | Metropolitan Smokers' Station | 68 | 86876194371 |
| FGR93400SM | Silver Metallic | Metropolitan Smokers' Station | 68 | 86876194388 |
| FGS21600GY00 | Gray | Wall Washer Kit Includes 1 Wood Handle, 1 Plastic Head, 2 Cotton Pads | 132 | 86876126006 |
| FGS22600GY00 | Gray | Wall Washer Kit Includes 1 Aluminum Handle, 1 Plastic Head, 2 Cotton Pads | 132 | 86876125634 |
| FGS25 | | White Silica Sand, five 5-lb Bags | 70 | |
| FGS29900WH00 | White | Wall Washer Replacement Pads, Launderable Cotton | 132 | 86876126020 |
| FGS3ETBKPL | Black Gloss | Open Top 94L/25G | 50 | 97591106686 |
| FGS3ETHBZPL | Textured Bronze | Open Top 94L/25G | 50 | 97591103791 |
| FGS3ETSMPLBK | Stardust Silver Metallic w/ Black Lid | Open Top 94L/25G | 50 | 97591108314 |
| FGS3SSSSPL | Stainless Steel | Open Top 94L/25G | 50 | 97591107034 |
| FGS55ETBKPL | Textured Black | Open Top 193L/51G | 50 | 97591106693 |

| PART NO. | Color | DESCRIPTION | PAGE | UPC |
|---------------|---------------------------------------|---|------|-------------|
| FGS55ETSMPLBK | Stardust Silver Metallic w/ Black Lid | Open Top 193L/51G | 50 | 97591113608 |
| FGS55STSSPL | Stainless Steel | Open Top 193L/51G | 50 | 97591107126 |
| FGSBR52BK | Black | Street Basket | 64 | 97591101254 |
| FGSBR52 | Galvanized Steel | Street Basket | 64 | 97591101254 |
| FGSC10ERBTBK | Textured Black | Square Open Top 37L/10G | 14 | 97591107195 |
| FGSC14EPLTBK | Textured Black | Square Open Top 60L/16G | 14 | 97591107256 |
| FGSC14ERBTBK | Textured Black | Square Open Top 90L/24G | 14 | 97591107232 |
| FGSC14SSPL | Stainless Steel | Square Open Top 60L/16G | 14 | 97591107263 |
| FGSC14SSRB | Stainless Steel | Square Open Top 90L/24G | 14 | 97591107249 |
| FGSC18EPLSM | Stardust Silver Metallic | Square Open Top 75L/20G | 14 | 97591123331 |
| FGSC18EPLTBK | Textured Black | Square Open Top 75L/20G | 14 | 97591107294 |
| FGSC18ERBDP | Desert Pearl | Square Open Top 109L/29G | 14 | 97591123324 |
| FGSC18ERBSM | Stardust Silver Metallic | Square Open Top 109L/29G | 14 | 97591123348 |
| FGSC18ERBTBK | Textured Black | Square Open Top 109L/29G | 14 | 97591107270 |
| FGSC18SSPL | Stainless Steel | Square Open Top 75L/20G | 14 | 97591107300 |
| FGSC18SSRB | Stainless Steel | Square Open Top 109L/29G | 14 | 97591107287 |
| FGSC22EPLSM | Stardust Silver Metallic | Square Open Top 151L/40G | 14 | 97591123379 |
| FGSC22EPLTBK | Textured Black | Square Open Top 151L/40G | 14 | 97591123416 |
| FGSC22ERBDP | Desert Pearl | Square Open Top 189L/50G | 14 | 97591123409 |
| FGSC22ERBSM | Stardust Silver Metallic | Square Open Top 189L/50G | 14 | 97591123386 |
| FGSC22ERBTBK | Textured Black | Square Open Top 189L/50G | 14 | 97591123423 |
| FGSC22SSPL | Stainless Steel | Square Open Top 151L/40G | 14 | 97591123355 |
| FGSC22SSRB | Stainless Steel | Square Open Top 189L/50G | 14 | 97591123362 |
| FGSCSUSS | Stainless Steel | Square Sand Urn | 15 | 97591107188 |
| FGSCSUTBK | Textured Black | Square Sand Urn | 15 | 97591107171 |
| FGSH12EPLSM | Stardust Silver Metallic | Open Top 45L/12G | 54 | 97591123232 |
| FGSH12EPLTBK | Textured Black | Open Top 45L/12G | 54 | 97591123256 |
| FGSH12SSPL | Stainless Steel | Open Top 45L/12G | 54 | 97591123263 |
| FGSO1220PLBK | Black Gloss w/ Chrome Trim | Open Top 45L/12G | 54 | 97591123218 |
| FGSO12SSSPL | Stainless Steel | Open Top 45L/12G | 54 | 97591123225 |
| FGSO16SSSGL | Stainless Steel | Flat Top 45L/12G | 54 | 97591010754 |
| FGSO16SUSSSGL | Stainless Steel | Ash/Trash 45L/12G | 54 | 97591010839 |
| FGSO820PLANT | Anthracite w/ Chrome Trim | Flat Top 34L/9G | 54 | 97591101124 |
| FGSO820PLBK | Black Gloss w/ Chrome Trim | Flat Top 34L/9G | 54 | 97591041093 |
| FGSO8SSSPL | Stainless Steel | Flat Top 34L/9G | 54 | 97591104293 |
| FGSO8SU20PLBK | Black Gloss w/ Chrome Trim | Ash/Trash 34L/9G | 54 | 97591011980 |
| FGSO8SUSSSPL | Stainless Steel | Ash/Trash 34L/9G | 54 | 97591104309 |
| FGSR14EPLSM | Stardust Silver Metallic | Small Rectangle 49L/13G | 51 | 97591123430 |
| FGSR14EPLTBK | Textured Black | Small Rectangle 49L/13G | 51 | 97591110614 |
| FGSR14ERBDP | Desert Pearl | Small Rectangle 94L/25G | 51 | 97591123461 |
| FGSR14ERBSM | Stardust Silver Metallic | Small Rectangle 94L/25G | 51 | 97591123447 |
| FGSR14ERBTBK | Textured Black | Small Rectangle 94L/25G | 51 | 97591110553 |
| FGSR14SSPL | Stainless Steel | Small Rectangle 49L/13G | 51 | 97591110621 |
| FGSR14SSRB | Stainless Steel | Small Rectangle 94L/25G | 51 | 97591110577 |
| FGSR18EPLSM | Stardust Silver Metallic | Large Rectangle 85L/22.5G | 51 | 97591123478 |
| FGSR18EPLTBK | Textured Black | Large Rectangle 85L/22.5G | 51 | 97591110652 |
| FGSR18ERBDP | Desert Pearl | Large Rectangle 151L/40G | 51 | 97591123508 |
| FGSR18ERBSM | Stardust Silver Metallic | Large Rectangle 151L/40G | 51 | 97591123485 |
| FGSR18ERBTBK | Textured Black | Large Rectangle 151L/40G | 51 | 97591110638 |
| FGSR18SSPL | Stainless Steel | Large Rectangle 85L/22.5G | 51 | 97591110669 |
| FGSR18SSRB | Stainless Steel | Large Rectangle 151L/40G | 51 | 97591110645 |
| FGSSIG | | Smokers' Station® Wall-Mount In-Ground Pole w/ Hardware For Fgr1012 | 65 | 97591034057 |

| PART NO. | Color | DESCRIPTION | PAGE | UPC |
|--------------|-----------------|--|------|-------------|
| FGSSSM | | Smokers' Station® Wall-Mount/ Surface-Mount Pole w/ Hardware For Fgr1012 | 65 | 97591034200 |
| FGST12EPLRD | Red Gloss | Square Step Can 45L/12G | 52 | 97591001233 |
| FGST12EPLWH | Sky White Gloss | Square Step Can 45L/12G | 52 | 97591074053 |
| FGST12ERBRD | Red Gloss | Square Step Can 45L/12G | 52 | 97591074329 |
| FGST12ERBWH | Sky White Gloss | Square Step Can 45L/12G | 52 | 97591074039 |
| FGST12SSPL | Stainless Steel | Square Step Can 45L/12G | 52 | 97591074022 |
| FGST12SSRB | Stainless Steel | Square Step Can 45L/12G | 52 | 97591074008 |
| FGST24EPLRD | Red Gloss | Square Step Can 90L/24G | 52 | 97591002469 |
| FGST24EPLWH | Sky White Gloss | Square Step Can 90L/24G | 52 | 97591074114 |
| FGST24ERBRD | Red Gloss | Square Step Can 90L/24G | 52 | 97591073988 |
| FGST24ERBWH | Sky White Gloss | Square Step Can 91L/24G | 52 | 97591074091 |
| FGST24SSPL | Stainless Steel | Square Step Can 90L/24G | 52 | 97591074084 |
| FGST24SSRB | Stainless Steel | Square Step Can 91L/24G | 52 | 97591074060 |
| FGST40EPLRD | Red Gloss | Square Step Can 151L/40G | 52 | 97591002452 |
| FGST40EPLRD | Red Gloss | Square Step Can w/ Wheels 151L/40G | 52 | 97591002452 |
| FGST40EPLWH | Sky White Gloss | Square Step Can 151 L/40 G | 52 | 97591074176 |
| FGST40ERBRD | Red Gloss | Square Step Can 151L/40G | 52 | 97591074336 |
| FGST40ERBRD | Red Gloss | Square Step Can w/ Wheels 151L/40G | 52 | 97591074336 |
| FGST40EWRBWH | Sky White Gloss | Square Step Can w/ Wheels 151L/40G | 52 | 97591073902 |
| FGST7EPLRD | Red Gloss | Square Step Can 26L/7G | 52 | 97591006450 |
| FGST7EPLWH | Sky White Gloss | Square Step Can 26L/7G | 52 | 97591073728 |
| FGST7ERBRD | Red Gloss | Square Step Can 26L/7G | 52 | 97591005743 |
| FGST7ERBWH | Sky White Gloss | Square Step Can 26L/7G | 52 | 97591073711 |
| FGST7SSPL | Stainless Steel | Square Step Can 26L/7G | 52 | |
| FGST7SSRB | Stainless Steel | Square Step Can 26L/7G | 52 | |
| FGT11000GY00 | Gray | Overhead Dusting Tool with Launderable Head, 51" I (129.5 cm) Extension Handle | 125 | 86876125894 |
| FGT12000GY00 | Gray | Overhead Dusting Tool with Angled Launderable Head, 51" I (129.5 cm) Extension Handle | 125 | 86876125931 |
| FGT13000GY00 | Gray | Overhead Dusting Tool with Launderable Head, 8 1/2" I (2.6 m) Extension Handle | 125 | 86876125955 |
| FGT19900WH00 | White | Overhead Dusting Tool Replacement Head fits FGT11000, FGT12000, FGT13000 | 125 | 86876125979 |
| FGT20006WH00 | White | Nylon Finish Mop | 114 | 86876149203 |
| FGT20106WH00 | White | Nylon Finish Mop | 114 | 86876149210 |
| FGT25500WH00 | White | Rough-Floor Wet Mop | 114 | 86876161892 |
| FGT25600WH00 | White | Rough-Floor Wet Mop | 114 | 86876161908 |
| FGT30000WH00 | White | Clean Room Mop | 114 | 86876144390 |
| FGT30100WH00 | White | Clean Room Mop | 114 | 86876153361 |
| FGT410000000 | | Flexible-Head Overhead Dusting Tool, Flexible Head with 60" I (152.4 cm) Aluminum Handle | 125 | 86876050905 |
| FGT81206GR00 | Green | Web Foot® Microfiber Tube Mop | 103 | 86876201222 |
| FGT81306GR00 | Green | Web Foot® Microfiber Tube Mop | 103 | 86876201239 |
| FGT85206GR00 | Green | Web Foot® Microfiber Tube Mop | 103 | 86876201246 |
| FGT85306GR00 | Green | Web Foot® Microfiber Tube Mop | 103 | 86876201253 |
| FGU110000000 | | Wedge Mop Handle and Frame, Wood Handle with Metal Frame | 123 | 86876047929 |
| FGU12000YL00 | Yellow | Trapper® Wedge Mop Dust Mop Head, Looped-End | 123 | 86876145113 |

UTILITY AND RECYCLING REFUSE

DECORATIVE REFUSE

CLEANING

MATERIAL HANDLING

WASHROOM

FOODSERVICE

ACCESSORIES & INDEX



UTILITY AND
RECYCLING REFUSE

DECORATIVE REFUSE

CLEANING

MATERIAL HANDLING

WASHROOM

FOODSERVICE

ACCESSORIES
& INDEX

| PART NO. | Color | DESCRIPTION | PAGE | UPC |
|--------------|-----------------|---|------|-------------|
| FGU13000WH00 | White | Kut-A-Way® Wedge Mop Dust Mop Head, Cut-End | 123 | 86876144376 |
| FGU13067WH00 | White | Kut-A-Way® Wedge Mop Kit, Contains FGU13000 Mop, FGU11000 Handle, and Frame | 123 | 86876147889 |
| FGU21000WH00 | | Laundry Net, Synthetic Mesh Bag with Locking Closure | 116 | |
| FGU650SA | Satin Aluminum | Smokers' Station® Wall-Mount Urn | 65 | 97591012109 |
| FGV11600WH00 | White | Economy Cotton Cut-End Mop | 112 | 86876045994 |
| FGV11700WH00 | White | Economy Cotton Cut-End Mop | 112 | 86876046007 |
| FGV11800WH00 | White | Economy Cotton Cut-End Mop | 112 | 86876046014 |
| FGV11900WH00 | White | Economy Cotton Cut-End Mop | 112 | 86876046021 |
| FGV15600WH00 | White | Economy Cotton Cut-End Mop | 112 | 86876050998 |
| FGV15700WH00 | White | Economy Cotton Cut-End Mop | 112 | 86876051001 |
| FGV15800WH00 | White | Economy Cotton Cut-End Mop | 112 | 86876051018 |
| FGV15900WH00 | White | Economy Cotton Cut-End Mop | 112 | 86876051025 |
| FGV41600WH00 | White | Economy Rayon Cut-End Mop | 112 | 86876051049 |
| FGV41700WH00 | White | Economy Rayon Cut-End Mop | 112 | 86876045901 |
| FGV41800WH00 | White | Economy Rayon Cut-End Mop | 112 | 86876045918 |
| FGV41900WH00 | White | Economy Rayon Cut-End Mop | 112 | 86876051056 |
| FGWB2629GR | Green | Steel Wastebasket Open Top | 42 | 97591087800 |
| FGWB26AL | Almond | Steel Wastebasket Open Top | 42 | 97591042144 |
| FGWB26BK | Black | Steel Wastebasket Open Top | 42 | 97591086339 |
| FGWB26GR | Green | Steel Wastebasket Open Top | 42 | 97591085851 |
| FGWB29RSS | Stainless Steel | Concept Collection™ Open-Top Wastebasket | 39 | 97591106228 |
| FGWB30RAL | Almond | Steel Wastebasket Open Top | 42 | 97591042151 |
| FGWB30RGR | Green | Steel Wastebasket Open Top | 42 | 97591086360 |
| FGWB96RAL | Almond | Steel Wastebasket Open Top | 42 | 97591042168 |
| FGWB96RBK | Black | Steel Wastebasket Open Top | 42 | 97591087183 |
| FGWHB14EBK | Black | Hide-a-Bag Open-Top Wastebasket, Black | 39 | 97591109038 |
| FGWHB14SS | Stainless Steel | Hide-a-Bag Open-Top Wastebasket, Stainless | 39 | 97591109045 |
| FGWMB20BK | Black | Concept Collection™ Open-Top Wastebasket | 39 | 97591080061 |
| FGWMB30RBK | Black | Concept Collection™ Open-Top Wastebasket | 39 | 97591011324 |
| FGWU | | Weather Urn Top | 70 | |
| FGWU | | Weather Urn Top | 70 | |
| FGWU1 | | Weather Urn Tops | 70 | |
| FGWU3 | | Weather Urn Tops | 70 | |
| FGY16R | | Mechanical Portion Control Scale | 235 | 77177035357 |
| FGY32R | | Mechanical Portion Control Scale | 235 | 77177035333 |
| FGYG180R | | Mechanical Portion Control Scale | 235 | 77177035210 |
| FGYG425R | | Mechanical Portion Control Scale | 235 | 77177035418 |
| FGYG450R | | Mechanical Portion Control Scale | 235 | 77177035524 |
| M1564200 | | Wheel for FG564200, FG564261 | 186 | 86876173819 |
| M1566000 | | Wheel for FG566061 | 186 | 86876173970 |

| COMPONENT PART | COMPONENT DESCRIPTION | FITS | PAGE # (OF 'FITS' SKU) |
|----------------|---|---------------|------------------------|
| 1790072 | Glutton® 1-Stream Recycling Insert, Green | 1792373 | 41 |
| 1791803 | SRP Endcaps with 2 Screws, Black | FGQ55000YL00 | 81 |
| 1791803 | SRP Endcaps with 2 Screws, Black | FGQ56000YL00 | 81 |
| 1791803 | SRP Endcaps with 2 Screws, Black | FGQ58000YL00 | 283 |
| 1791803 | SRP Endcaps with 2 Screws, Black | FGQ59000YL00 | 283 |
| FG1005L40000 | 3.5" Casters with Hardware | FG130500BLA | 165 |
| FG1005L40000 | 3.5" Casters with Hardware | FG130500BLU | 165 |
| FG1005L40000 | 3.5" Casters with Hardware | FG130500RED | 165 |
| FG1005L40000 | 3.5" Casters with Hardware | FG130500YEL | 165 |
| FG1005L40000 | 3.5" Casters with Hardware | FG130573BLU | 165 |
| FG1005L40000 | 3.5" Casters with Hardware | FG130600BLA | 165 |
| FG1011L10000 | 12" Wheel with Hardware | FG101100BLA | 164 |
| FG1011L20000 | 4" Caster with Hardware | FG101100BLA | 164 |
| FG1013L10000 | 12" Wheel with Hardware | FG101300BLA | 164 |
| FG1013L20000 | 4" Caster with Hardware | FG101300BLA | 164 |
| FG1013L20000 | 4" Caster with Hardware | FG9T1400BLA | 164 |
| FG1014L30000 | 12" Wheel with Hardware | FG131400BLA | 165 |
| FG1025L40000 | 4" Swivel Caster with Hardware | FG102500BLA | 165 |
| FG1025L40000 | 4" Swivel Caster with Hardware | FG102600BLA | 165 |
| FG1025L40000 | 4" Swivel Caster with Hardware | FG103500BLA | 165 |
| FG1025L40000 | 4" Swivel Caster with Hardware | FG103600BLA | 165 |
| FG1025L40000 | 4" Swivel Caster with Hardware | FG104500BLA | 165 |
| FG1025L40000 | 4" Swivel Caster with Hardware | FG104600BLA | 165 |
| FG1025L5BLA | Frame Assembly for Tilt Truck, Black | FG102500BLA | 165 |
| FG1025L5RED | Frame Assembly for Tilt Truck, Red | FG102500BLA | 165 |
| FG1026L5BLA | Frame Assembly for Tilt Truck, Black | FG102600BLA | 165 |
| FG1026L5RED | Frame Assembly for Tilt Truck, Red | FG102600BLA | 165 |
| FG1026L60000 | 12" Wheel with Hardware | FG103500BLA | 165 |
| FG1026L60000 | 12" Wheel with Hardware | FG103600BLA | 165 |
| FG1026L60000 | 12" Wheel with Hardware | FG104500BLA | 165 |
| FG1026L60000 | 12" Wheel with Hardware | FG104600BLA | 165 |
| FG1035L5BLA | Frame Assembly for Tilt Truck, Black | FG103500BLA | 165 |
| FG1035L5RED | Frame Assembly for Tilt Truck, Red | FG103500BLA | 165 |
| FG1045L5BLA | Frame Assembly for Tilt Truck, Black | FG104500BLA | 165 |
| FG1045L5RED | Frame Assembly for Tilt Truck, Red | FG104500BLA | 165 |
| FG1046L5RED | Frame Assembly for Tilt Truck, Red | FG104600BLA | 165 |
| FG1054L40000 | 6" Swivel Caster with Hardware | FG105943BLA | 167 |
| FG1054L40000 | 6" Swivel Caster with Hardware | FG107443BLA | 167 |
| FG1054L50000 | 6" Rigid Caster with Hardware | FG107443BLA | 167 |
| FG1304L2RED | Frame Assembly for Tilt Truck, Red | FG130400BLA | 165 |
| FG1304L30000 | 4" Swivel Threaded Caster | FG130400BLA | 165 |
| FG1305L2BLA | Frame Assembly for Tilt Truck, Black | FG130500BLA | 165 |
| FG1305L2BLA | Frame Assembly for Tilt Truck, Black | FG130500DBLUE | 165 |
| FG1305L2BLA | Frame Assembly for Tilt Truck, Black | FG130500RED | 165 |
| FG1305L2BLA | Frame Assembly for Tilt Truck, Black | FG130500YEL | 165 |

| COMPONENT PART | COMPONENT DESCRIPTION | FITS | PAGE # (OF 'FITS' SKU) |
|----------------|--|---------------|------------------------|
| FG1305L2BLA | Frame Assembly for Tilt Truck, Black | FG130600BLA | 165 |
| FG1305L2RED | Frame Assembly for Tilt Truck, Red | FG130500BLA | 165 |
| FG1305L2RED | Frame Assembly for Tilt Truck, Red | FG130500DBLUE | 165 |
| FG1305L2RED | Frame Assembly for Tilt Truck, Red | FG130500RED | 165 |
| FG1305L2RED | Frame Assembly for Tilt Truck, Red | FG130500YEL | 165 |
| FG1305L2RED | Frame Assembly for Tilt Truck, Red | FG130600BLA | 165 |
| FG1305L4BLA | 1/2 & 1 cu yd Tilt Truck Handle, Black | FG130500BLA | 165 |
| FG1305L4BLA | 1/2 & 1 cu yd Tilt Truck Handle, Black | FG130500DBLUE | 165 |
| FG1305L4BLA | 1/2 & 1 cu yd Tilt Truck Handle, Black | FG130500RED | 165 |
| FG1305L4BLA | 1/2 & 1 cu yd Tilt Truck Handle, Black | FG130542BLA | 166 |
| FG1305L4BLA | 1/2 & 1 cu yd Tilt Truck Handle, Black | FG130573BLUE | 165 |
| FG1305L4BLA | 1/2 & 1 cu yd Tilt Truck Handle, Black | FG130600BLA | 165 |
| FG1305L4BLA | 1/2 & 1 cu yd Tilt Truck Handle, Black | FG130641BLA | 166 |
| FG1305L4BLA | 1/2 & 1 cu yd Tilt Truck Handle, Black | FG131400BLA | 165 |
| FG1305L4BLA | 1/2 & 1 cu yd Tilt Truck Handle, Black | FG131500BLA | 165 |
| FG1305L4BLA | 1/2 & 1 cu yd Tilt Truck Handle, Black | FG131500DBLUE | 165 |
| FG1305L4BLA | 1/2 & 1 cu yd Tilt Truck Handle, Black | FG131500RED | 165 |
| FG1305L4BLA | 1/2 & 1 cu yd Tilt Truck Handle, Black | FG131500YEL | 165 |
| FG1305L4BLA | 1/2 & 1 cu yd Tilt Truck Handle, Black | FG131600BLA | 165 |
| FG1305L4RED | 1/2 & 1 cu yd Tilt Truck Handle, Red | FG130500BLA | 165 |
| FG1305L4RED | 1/2 & 1 cu yd Tilt Truck Handle, Red | FG130500DBLUE | 165 |
| FG1305L4RED | 1/2 & 1 cu yd Tilt Truck Handle, Red | FG130500RED | 165 |
| FG1305L4RED | 1/2 & 1 cu yd Tilt Truck Handle, Red | FG130542BLA | 166 |
| FG1305L4RED | 1/2 & 1 cu yd Tilt Truck Handle, Red | FG130573BLUE | 165 |
| FG1305L4RED | 1/2 & 1 cu yd Tilt Truck Handle, Red | FG130600BLA | 165 |
| FG1305L4RED | 1/2 & 1 cu yd Tilt Truck Handle, Red | FG130641BLA | 166 |
| FG1305L4RED | 1/2 & 1 cu yd Tilt Truck Handle, Red | FG131400BLA | 165 |
| FG1305L4RED | 1/2 & 1 cu yd Tilt Truck Handle, Red | FG131500BLA | 165 |
| FG1305L4RED | 1/2 & 1 cu yd Tilt Truck Handle, Red | FG131500DBLUE | 165 |
| FG1305L4RED | 1/2 & 1 cu yd Tilt Truck Handle, Red | FG131500RED | 165 |
| FG1305L4RED | 1/2 & 1 cu yd Tilt Truck Handle, Red | FG131500YEL | 165 |
| FG1305L4RED | 1/2 & 1 cu yd Tilt Truck Handle, Red | FG131600BLA | 165 |
| FG1314L2BLA | Frame Assembly for Tilt Truck, Black | FG131400BLA | 165 |
| FG1314L30000 | 5" Swivel Threaded Caster | FG131400BLA | 165 |
| FG1315L2BLA | Frame Assembly for Tilt Truck, Black | FG131500BLA | 165 |
| FG1315L2BLA | Frame Assembly for Tilt Truck, Black | FG131500DBLUE | 165 |
| FG1315L2BLA | Frame Assembly for Tilt Truck, Black | FG131500RED | 165 |

| COMPONENT PART | COMPONENT DESCRIPTION | FITS | PAGE # (OF 'FITS' SKU) |
|----------------|---|---------------|------------------------|
| FG1315L2BLA | Frame Assembly for Tilt Truck, Black | FG131600BLA | 165 |
| FG1315L2RED | Frame Assembly for Tilt Truck, Red | FG131500BLA | 165 |
| FG1315L2RED | Frame Assembly for Tilt Truck, Red | FG131500DBLUE | 165 |
| FG1315L2RED | Frame Assembly for Tilt Truck, Red | FG131500RED | 165 |
| FG1315L2RED | Frame Assembly for Tilt Truck, Red | FG131600BLA | 165 |
| FG1315L30000 | 12" Wheel for 1 cu yd Tilt Truck | FG131500BLA | 165 |
| FG1315L30000 | 12" Wheel for 1 cu yd Tilt Truck | FG131500DBLUE | 165 |
| FG1315L30000 | 12" Wheel for 1 cu yd Tilt Truck | FG131500RED | 165 |
| FG1315L30000 | 12" Wheel for 1 cu yd Tilt Truck | FG131500YEL | 165 |
| FG1315L30000 | 12" Wheel for 1 cu yd Tilt Truck | FG9T1500BLA | 164 |
| FG1316L4RED | Hitch For Towable Trainable Tile Truck, Red | FG131641BLA | 166 |
| FG1316L4RED | Hitch For Towable Trainable Tile Truck, Red | FG472741BLA | 168 |
| FG2523L10000 | Step Stool Caster | FG252300BEIG | 284 |
| FG2523L10000 | Step Stool Caster | FG252300BLA | 284 |
| FG2523L3BLA | Step Stool Step Pad, Black | FG252300BEIG | 284 |
| FG2531L4BLA | Lobby Pro® Dust Pan Wheels, Black | FG253100BLA | 129 |
| FG2532L1BLA | Lobby Pro® Dust Pan Cover, Black | FG253200BLA | 129 |
| FG2532L2BLA | Lobby Pro® Handle, Black | FG253200BLA | 129 |
| FG2532L3BLA | Lobby Pro® Pan, Black | FG253300BLA | 129 |
| FG256RL2DGRN | Glutton® Square Insert, Dark Green | 1792339 | 41 |
| FG256RL2DGRN | Glutton® Square Insert, Dark Green | 1792340 | 41 |
| FG256RL2DGRN | Glutton® Square Insert, Dark Green | 1792371 | 41 |
| FG256RL2DGRN | Glutton® Square Insert, Dark Green | 1792372 | 41 |
| FG256RL2DGRN | Glutton® Square Insert, Dark Green | 1792373 | 41 |
| FG256RL2DGRN | Glutton® Square Insert, Dark Green | 1792374 | 41 |
| FG256RL3DGRN | Glutton® Paper Insert, Dark Green | 1792339 | 41 |
| FG256RL3DGRN | Glutton® Paper Insert, Dark Green | 1792340 | 41 |
| FG256RL3DGRN | Glutton® Paper Insert, Dark Green | 1792372 | 41 |
| FG256RL3DGRN | Glutton® Paper Insert, Dark Green | 1792373 | 41 |
| FG256RL4DGRN | Glutton® Circle Insert, Dark Green | 1792339 | 41 |
| FG256RL4DGRN | Glutton® Circle Insert, Dark Green | 1792340 | 41 |
| FG256RL4DGRN | Glutton® Circle Insert, Dark Green | 1792371 | 41 |
| FG256RL4DGRN | Glutton® Circle Insert, Dark Green | 1792372 | 41 |
| FG256RL4DGRN | Glutton® Circle Insert, Dark Green | 1792373 | 41 |
| FG256RL4DGRN | Glutton® Circle Insert, Dark Green | 1792374 | 41 |
| FG256RL5DGRN | Glutton® Triangle Insert, Dark Green | 1792339 | 41 |
| FG256RL5DGRN | Glutton® Triangle Insert, Dark Green | 1792340 | 41 |
| FG256RL5DGRN | Glutton® Triangle Insert, Dark Green | 1792371 | 41 |
| FG256RL5DGRN | Glutton® Triangle Insert, Dark Green | 1792372 | 41 |

UTILITY AND RECYCLING REFUSE

DECORATIVE REFUSE

CLEANING

MATERIAL HANDLING

WASHROOM

FOODSERVICE

ACCESSORIES & INDEX



| COMPONENT PART | COMPONENT DESCRIPTION | FITS | PAGE # (OF 'FITS' SKU) |
|----------------|--|---------------|---------------------------|
| FG256RL5DGRN | Glutton® Triangle Insert, Dark Green | 1792373 | 41 |
| FG256RL5DGRN | Glutton® Triangle Insert, Dark Green | 1792374 | 41 |
| FG2570L4BEIG | Replacement GroundsKeeper® Receptacle, Beige | FG257088BEIG | 284 |
| FG2570L4BEIG | Replacement GroundsKeeper® Receptacle, Beige | FG257088BLA | 284 |
| FG2570L4BEIG | Replacement GroundsKeeper® Receptacle, Beige | FG9W3000BLA | 284 |
| FG2570L4BEIG | Replacement GroundsKeeper® Receptacle, Beige | FG9W3000SSTON | 284 |
| FG2570L4BLA | Replacement GroundsKeeper® Receptacle, Black | FG257088BEIG | 284 |
| FG2570L4BLA | Replacement GroundsKeeper® Receptacle, Black | FG257088BLA | 284 |
| FG2570L4BLA | Replacement GroundsKeeper® Receptacle, Black | FG257088BRN | 284 |
| FG2570L4BLA | Replacement GroundsKeeper® Receptacle, Black | FG9W3000BLA | 284 |
| FG2570L4BLA | Replacement GroundsKeeper® Receptacle, Black | FG9W3000SSTON | 284 |
| FG2570L4BRN | Replacement GroundsKeeper® Receptacle, Brown | FG257088BEIG | 284 |
| FG2570L4BRN | Replacement GroundsKeeper® Receptacle, Brown | FG257088BLA | 284 |
| FG2570L4BRN | Replacement GroundsKeeper® Receptacle, Brown | FG9W3000BLA | 284 |
| FG2570L4BRN | Replacement GroundsKeeper® Receptacle, Brown | FG9W3000SSTON | 284 |
| FG2586L1BLA | Smoking Urn Metal Liner, Black | FG258600BLA | 80 |
| FG2650L10000 | 3" Plastic Dolly Caster | FG265000BLA | 94 |
| FG2664L1BEIG | Untouchable® Square Swing Top Replaceable Doors, Beige | FG266400BEIG | 113 |
| FG2664L1BEIG | Untouchable® Square Swing Top Replaceable Doors, Beige | FG266400GRAY | 113 |
| FG2664L1GRAY | Untouchable® Square Swing Top Replaceable Doors, Gray | FG266400BEIG | 113 |
| FG2779L1BEIG | Untouchable® Round Swing Top Replaceable Door, Beige | FG267200BEIG | 113 |
| FG3316L2WHT | Replacement Cutting Board, White | FG331600BLA | 319 |
| FG3421L60000 | 3" Caster Kit (4) | FG342100BLA | 233 |
| FG3421L60000 | 3" Caster Kit (4) | FG9T6571BEIG | 233 |
| FG3424L60000 | 4" Swivel Caster with Insert | FG335588PLAT | 233 |
| FG3424L60000 | 4" Swivel Caster with Insert | FG342488BLA | 233 |
| FG3424L60000 | 4" Swivel Caster with Insert | FG342488OWHT | 233 |
| FG3424L60000 | 4" Swivel Caster with Insert | FG342488PLAT | 233 |
| FG3424L60000 | 4" Swivel Caster with Insert | FG342488RED | 233 |
| FG3424L60000 | 4" Swivel Caster with Insert | FG345700BLA | 233 |
| FG3424L60000 | 4" Swivel Caster with Insert | FG409100BLA | 234 |
| FG3424L60000 | 4" Swivel Caster with Insert | FG409100BLA | 234 |
| FG3424L60000 | 4" Swivel Caster with Insert | FG409100GRAY | 234 |
| FG3424L60000 | 4" Swivel Caster with Insert | FG409100GRAY | 234 |
| FG3424L60000 | 4" Swivel Caster with Insert | FG409100OWHT | 234 |
| FG3424L60000 | 4" Swivel Caster with Insert | FG409100OWHT | 234 |
| FG3424L60000 | 4" Swivel Caster with Insert | FG409300BLA | 234 |
| FG3424L60000 | 4" Swivel Caster with Insert | FG409300OWHT | 234 |
| FG3424L60000 | 4" Swivel Caster with Insert | FG409400GRAY | 234 |
| FG3424L60000 | 4" Swivel Caster with Insert | FG409400GRAY | 234 |
| FG3424L60000 | 4" Swivel Caster with Insert | FG409500BLA | 234 |
| FG3424L60000 | 4" Swivel Caster with Insert | FG9T6800BLA | 232 |
| FG3424L60000 | 4" Swivel Caster with Insert | FG9T7200BLA | 193 |
| FG3424L60000 | 4" Swivel Caster with Insert | FG9T7300BLA | 192 |
| FG3424L60000 | 4" Swivel Caster with Insert | FG9T7400BLA | 192 |
| FG3424L60000 | 4" Swivel Caster with Insert | FG9T7800BLA | 195 |
| FG3530L10000 | 3" Swivel Caster with Stem and Hardware | FG264000BLA | 94 |
| FG3530L10000 | 3" Swivel Caster with Stem and Hardware | FG353000BLA | 94 |

| COMPONENT PART | COMPONENT DESCRIPTION | FITS | PAGE # (OF 'FITS' SKU) |
|----------------|--|---------------|---------------------------|
| FG3559L30000 | Axle for BRUTE® Rollout Containers | 1829410 | 99 |
| FG3559L30000 | Axle for BRUTE® Rollout Containers | 1829411 | 99 |
| FG3559L30000 | Axle for BRUTE® Rollout Containers | FG9W2700BLUE | 99 |
| FG3559L30000 | Axle for BRUTE® Rollout Containers | FG9W2700GRAY | 99 |
| FG3559L30000 | Axle for BRUTE® Rollout Containers | FG9W2773BLUE | 100 |
| FG3964L30000 | Plaza® Container Latch Kit | FG396400BEIG | 75 |
| FG3964L30000 | Plaza® Container Latch Kit | FG396400BLA | 75 |
| FG3964L30000 | Plaza® Container Latch Kit | FG396500BEIG | 75 |
| FG3964L50000 | Plaza® Container Hardware Kit | FG396400BEIG | 75 |
| FG3964L50000 | Plaza® Container Hardware Kit | FG396400BLA | 75 |
| FG3964L50000 | Plaza® Container Hardware Kit | FG396400DGRN | 75 |
| FG3964L50000 | Plaza® Container Hardware Kit | FG396500BEIG | 75 |
| FG3964L60000 | Plaza® Container Lock & Key | FG396300BEIG | 75 |
| FG3964L60000 | Plaza® Container Lock & Key | FG396300BLA | 75 |
| FG3964L60000 | Plaza® Container Lock & Key | FG396400BEIG | 75 |
| FG3964L60000 | Plaza® Container Lock & Key | FG396400BLA | 75 |
| FG3964L60000 | Plaza® Container Lock & Key | FG396400DGRN | 75 |
| FG3964L60000 | Plaza® Container Lock & Key | FG396500BEIG | 75 |
| FG3964L60000 | Plaza® Container Lock & Key | FG396900DGRN | 117 |
| FG3964L60000 | Plaza® Container Lock & Key | FG9P9000BEIG | 75 |
| FG3964L60000 | Plaza® Container Lock & Key | FG9P9000BLA | 75 |
| FG3964L60000 | Plaza® Container Lock & Key | FG9P9000DGRN | 75 |
| FG3965L10000 | Plaza® Container Ash Tray Kit | FG396500BEIG | 75 |
| FG3965L10000 | Plaza® Container Ash Tray Kit | FG9P9100BLA | 75 |
| FG3970L40000 | Landmark Series® Lock & Keys | FG397000BLA | 73 |
| FG3970L40000 | Landmark Series® Lock & Keys | FG397000DWOOD | 73 |
| FG3970L40000 | Landmark Series® Lock & Keys | FG397500BLA | 76 |
| FG3970L40000 | Landmark Series® Lock & Keys | FG397500DWOOD | 76 |
| FG3970L40000 | Landmark Series® Lock & Keys | FG397500SBLE | 76 |
| FG3972L20000 | Hardware Kit | FG397000BLA | 73 |
| FG3972L20000 | Hardware Kit | FG397000DWOOD | 73 |
| FG3972L20000 | Hardware Kit | FG397001BLA | 73 |
| FG3972L20000 | Hardware Kit | FG397001DWOOD | 73 |
| FG3972L20000 | Hardware Kit | FG397001SBLE | 73 |
| FG3972L20000 | Hardware Kit | FG397088BLA | 73 |
| FG3972L20000 | Hardware Kit | FG397100DWOOD | 73 |
| FG3972L20000 | Hardware Kit | FG397100SBLE | 73 |
| FG3972L20000 | Hardware Kit | FG397200SBLE | 73 |
| FG3972L20000 | Hardware Kit | FG397500BLA | 76 |
| FG3972L20000 | Hardware Kit | FG397500DWOOD | 76 |
| FG3972L20000 | Hardware Kit | FG397500SBLE | 76 |
| FG3972L20000 | Hardware Kit | FG397501BLA | 76 |
| FG3972L20000 | Hardware Kit | FG397501DWOOD | 76 |
| FG3972L20000 | Hardware Kit | FG397501SBLE | 76 |
| FG3975L1BLA | Landmark Series® Dome Top Replacement, Black | FG397000BLA | 73 |
| FG3975L1BLA | Landmark Series® Dome Top Replacement, Black | FG397000DWOOD | 73 |
| FG3975L1BLA | Landmark Series® Dome Top Replacement, Black | FG397500BLA | 76 |
| FG3975L1BLA | Landmark Series® Dome Top Replacement, Black | FG397500DWOOD | 76 |
| FG3975L1BLA | Landmark Series® Dome Top Replacement, Black | FG397500SBLE | 76 |
| FG3975L1DWOOD | Landmark Series® Dome Top Replacement, Driftwood | FG397000BLA | 73 |
| FG3975L1DWOOD | Landmark Series® Dome Top Replacement, Driftwood | FG397000DWOOD | 73 |
| FG3975L1DWOOD | Landmark Series® Dome Top Replacement, Driftwood | FG397500BLA | 76 |
| FG3975L1DWOOD | Landmark Series® Dome Top Replacement, Driftwood | FG397500DWOOD | 76 |
| FG3975L1DWOOD | Landmark Series® Dome Top Replacement, Driftwood | FG397500SBLE | 76 |
| FG3975L1SBLE | Landmark Series® Dome Top Replacement, Sable | FG397000BLA | 73 |

| COMPONENT PART | COMPONENT DESCRIPTION | FITS | PAGE # (OF 'FITS' SKU) |
|----------------|---|---------------|------------------------|
| FG3975L1SBLE | Landmark Series® Dome Top Replacement, Sable | FG397000DWOOD | 73 |
| FG3975L1SBLE | Landmark Series® Dome Top Replacement, Sable | FG397500BLA | 76 |
| FG3975L1SBLE | Landmark Series® Dome Top Replacement, Sable | FG397500DWOOD | 76 |
| FG3975L1SBLE | Landmark Series® Dome Top Replacement, Sable | FG397500SBLE | 76 |
| FG3975L3DWOOD | Landmark Series® Stationary/ Moving Collar, Driftwood | FG397000BLA | 73 |
| FG3975L3DWOOD | Landmark Series® Stationary/ Moving Collar, Driftwood | FG397000DWOOD | 73 |
| FG3975L3DWOOD | Landmark Series® Stationary/ Moving Collar, Driftwood | FG397500BLA | 76 |
| FG3975L3DWOOD | Landmark Series® Stationary/ Moving Collar, Driftwood | FG397500DWOOD | 76 |
| FG3975L3DWOOD | Landmark Series® Stationary/ Moving Collar, Driftwood | FG397500SBLE | 76 |
| FG3975L3SBLE | Landmark Series® Stationary/ Moving Collar, Sable | FG397000BLA | 73 |
| FG3975L3SBLE | Landmark Series® Stationary/ Moving Collar, Sable | FG397000DWOOD | 73 |
| FG3975L3SBLE | Landmark Series® Stationary/ Moving Collar, Sable | FG397500BLA | 76 |
| FG3975L3SBLE | Landmark Series® Stationary/ Moving Collar, Sable | FG397500DWOOD | 76 |
| FG3975L3SBLE | Landmark Series® Stationary/ Moving Collar, Sable | FG397500SBLE | 76 |
| FG3975L6DWOOD | Landmark Series® Deco Leg | FG397500BLA | 76 |
| FG3975L6DWOOD | Landmark Series® Deco Leg | FG397500DWOOD | 76 |
| FG4094L1BLA | Door Kit with Lock for Xtra™ Cart, Black | FG409400GRAY | 234 |
| FG4094L1BLA | Door Kit with Lock for Xtra™ Cart, Black | FG409500BLA | 234 |
| FG4094L1LGRAY | Door Kit with Lock for Xtra™ Cart, Gray | FG409400GRAY | 234 |
| FG4094L1LGRAY | Door Kit with Lock for Xtra™ Cart, Gray | FG409500BLA | 234 |
| FG4401L10000 | Caterer's Trolley Wheel Kit | FG440186BLA | 318 |
| FG4401L10000 | Caterer's Trolley Wheel Kit | FG9F1600CGRAY | 317 |
| FG4402L10000 | 5" Rubber Swivel Caster | FG131500BLA | 240 |
| FG4402L10000 | 5" Rubber Swivel Caster | FG131500DBLUE | 240 |
| FG4402L10000 | 5" Rubber Swivel Caster | FG131500RED | 240 |
| FG4402L10000 | 5" Rubber Swivel Caster | FG131500YEL | 240 |
| FG4402L10000 | 5" Rubber Swivel Caster | FG440300BLA | 323 |
| FG4402L40000 | 8" Pneumatic Rigid Caster | FG443610BLA | 218 |
| FG4402L40000 | 8" Pneumatic Rigid Caster | FG446610BLA | 218 |
| FG4403L10000 | Hardware Kit | FG440300 | 323 |
| FG4403L10000 | Hardware Kit | FG440600 | 218 |
| FG4403L10000 | Hardware Kit | FG443600 | 218 |
| FG4403L10000 | Hardware Kit | FG443610 | 218 |
| FG4403L10000 | Hardware Kit | FG444100 | 218 |
| FG4403L10000 | Hardware Kit | FG446200 | 220 |
| FG4403L10000 | Hardware Kit | FG446300 | 220 |
| FG4403L10000 | Hardware Kit | FG446400 | 220 |
| FG4403L10000 | Hardware Kit | FG446600 | 218 |
| FG4403L10000 | Hardware Kit | FG446700 | 220 |
| FG4403L10000 | Hardware Kit | FG446800 | 220 |
| FG4403L10000 | Hardware Kit | FG446900 | 220 |
| FG4403L10000 | Hardware Kit | FG447100 | 218 |
| FG4403L10000 | Hardware Kit | FG448600 | 223 |
| FG4406L60000 | 6" Poly Swivel and Fixed Caster Replacement Kit | FG440600BLA | 218 |
| FG4436L80000 | 8" TPR Swivel and Fixed Caster Replacement Kit | FG443600BLA | 218 |
| FG4436L80000 | 8" TPR Swivel and Fixed Caster Replacement Kit | FG446600BLA | 218 |
| FG4436L80000 | 8" TPR Swivel and Fixed Caster Replacement Kit | FG448600BLA | 223 |
| FG4436M10000 | 8" Pneumatic Swivel & Fixed Caster Replacement Kit | FG443610BLA | 218 |

| COMPONENT PART | COMPONENT DESCRIPTION | FITS | PAGE # (OF 'FITS' SKU) |
|----------------|--|--------------|------------------------|
| FG4436M10000 | 8" Pneumatic Swivel & Fixed Caster Replacement Kit | FG446610BLA | 218 |
| FG4441L10000 | 8" Poly Swivel and Fixed Caster Replacement Kit | FG444100BLA | 218 |
| FG4441L10000 | 8" Poly Swivel and Fixed Caster Replacement Kit | FG446300BLA | 220 |
| FG4441L10000 | 8" Poly Swivel and Fixed Caster Replacement Kit | FG446800BLA | 220 |
| FG4441L10000 | 8" Poly Swivel and Fixed Caster Replacement Kit | FG447100BLA | 218 |
| FG4500L50000 | Hardware Kit | FG452010BEIG | 230 |
| FG4500L50000 | Hardware Kit | FG452010BLA | 230 |
| FG4500M20000 | Hardware Kit | FG450088BEIG | 230 |
| FG4500M20000 | Hardware Kit | FG450088BLA | 230 |
| FG4500M20000 | Hardware Kit | FG452010BEIG | 230 |
| FG4500M20000 | Hardware Kit | FG452010BLA | 230 |
| FG4500M20000 | Hardware Kit | FG452088BEIG | 230 |
| FG4500M20000 | Hardware Kit | FG452088BLA | 230 |
| FG4500M20000 | Hardware Kit | FG452500BEIG | 230 |
| FG4500M20000 | Hardware Kit | FG452500BLA | 230 |
| FG4500M20000 | Hardware Kit | FG454600BLA | 230 |
| FG4500M20000 | Hardware Kit | FG454610BEIG | 230 |
| FG4500M20000 | Hardware Kit | FG454610BLA | 230 |
| FG4501L10000 | 5" Rigid Caster | FG430000BLA | 320 |
| FG4501L10000 | 5" Rigid Caster | FG430000BLA | 320 |
| FG4501L10000 | 5" Rigid Caster | FG440100BLA | 323 |
| FG4501L10000 | 5" Rigid Caster | FG440100BLA | 323 |
| FG4501L10000 | 5" Rigid Caster | FG450088BEIG | 230 |
| FG4501L10000 | 5" Rigid Caster | FG450088BLA | 230 |
| FG4501L10000 | 5" Rigid Caster | FG450500BEIG | 230 |
| FG4501L10000 | 5" Rigid Caster | FG450500BEIG | 230 |
| FG4501L10000 | 5" Rigid Caster | FG450500BLA | 230 |
| FG4501L10000 | 5" Rigid Caster | FG450500BLA | 230 |
| FG4501L10000 | 5" Rigid Caster | FG452500BEIG | 230 |
| FG4501L10000 | 5" Rigid Caster | FG452500BLA | 230 |
| FG4501L10000 | 5" Rigid Caster | FG618000BLA | 227 |
| FG4501L20000 | 5" Swivel Caster | FG440100BLA | 323 |
| FG4501L20000 | 5" Swivel Caster | FG450088BEIG | 230 |
| FG4501L20000 | 5" Swivel Caster | FG450088BLA | 230 |
| FG4501L20000 | 5" Swivel Caster | FG450500BEIG | 230 |
| FG4501L20000 | 5" Swivel Caster | FG450500BLA | 230 |
| FG4501L20000 | 5" Swivel Caster | FG450500BLA | 230 |
| FG4501L20000 | 5" Swivel Caster | FG452088BEIG | 230 |
| FG4501L20000 | 5" Swivel Caster | FG452088BLA | 230 |
| FG4501L20000 | 5" Swivel Caster | FG452500BEIG | 230 |
| FG4501L20000 | 5" Swivel Caster | FG452500BLA | 230 |
| FG4505L30000 | Caster Kit for Flat Shelf Carts | FG450089BEIG | 230 |
| FG4505L30000 | Caster Kit for Flat Shelf Carts | FG450089BLA | 230 |
| FG4505L30000 | Caster Kit for Flat Shelf Carts | FG450500BEIG | 230 |
| FG4505L30000 | Caster Kit for Flat Shelf Carts | FG450589BEIG | 230 |
| FG4505L30000 | Caster Kit for Flat Shelf Carts | FG450589BLA | 230 |
| FG4505L30000 | Caster Kit for Flat Shelf Carts | FG452089BEIG | 230 |
| FG4505L30000 | Caster Kit for Flat Shelf Carts | FG452089BLA | 230 |
| FG4505L30000 | Caster Kit for Flat Shelf Carts | FG452500BEIG | 230 |
| FG4505L30000 | Caster Kit for Flat Shelf Carts | FG452500BLA | 230 |
| FG4505L30000 | Caster Kit for Flat Shelf Carts | FG452589BEIG | 230 |
| FG4505L30000 | Caster Kit for Flat Shelf Carts | FG452589BLA | 230 |
| FG4510L30000 | Hardware Kit | FG450088BEIG | 230 |
| FG4510L30000 | Hardware Kit | FG450088BLA | 230 |
| FG4510L30000 | Hardware Kit | FG452088BLA | 230 |
| FG4510L30000 | Hardware Kit | FG454600BEIG | 230 |
| FG4510L30000 | Hardware Kit | FG454600BLA | 230 |
| FG4512L3RED | Left Door (Small) for TradeMaster® Cart | FG451288BLA | 226 |
| FG4512L4RED | Right Door (Small) for TradeMaster® Cart | FG451288BLA | 226 |

UTILITY AND RECYCLING REFUSE

DECORATIVE REFUSE

CLEANING

MATERIAL HANDLING

WASHROOM

FOODSERVICE

ACCESSORIES & INDEX



| COMPONENT PART | COMPONENT DESCRIPTION | FITS | PAGE # (OF 'FITS' SKU) |
|----------------|---|---------------|------------------------|
| FG6189L30000 | Vacuum Cleaner Holder Kit | FG619000BLA | 200 |
| FG6189L30000 | Vacuum Cleaner Holder Kit | FG619100BLA | 200 |
| FG6189L30000 | Vacuum Cleaner Holder Kit | FG619200BLA | 200 |
| FG6191L10000 | Lock with Key Set | FG619100BLA | 200 |
| FG6191L10000 | Lock with Key Set | FG619200BLA | 200 |
| FG6191L10000 | Lock with Key Set | FG619700BLA | 201 |
| FG6191L10000 | Lock with Key Set | FG9T1900BLA | 200 |
| FG7570L20000 | 3" Plastic Caster with Metal Axle | FG748000YEL | 148 |
| FG7570L20000 | 3" Plastic Caster with Metal Axle | FG757088YEL | 149 |
| FG7570L20000 | 3" Plastic Caster with Metal Axle | FG757688YEL | 148 |
| FG7570L20000 | 3" Plastic Caster with Metal Axle | FG757788BRN | 146 |
| FG7570L20000 | 3" Plastic Caster with Metal Axle | FG757788YEL | 146 |
| FG7570L20000 | 3" Plastic Caster with Metal Axle | FG758888BLUE | 146 |
| FG7570L20000 | 3" Plastic Caster with Metal Axle | FG758888GRN | 146 |
| FG7570L20000 | 3" Plastic Caster with Metal Axle | FG758888RED | 146 |
| FG7570L20000 | 3" Plastic Caster with Metal Axle | FG759088YEL | 146 |
| FG7570L20000 | 3" Plastic Caster with Metal Axle | FGQ93000BLUE | |
| FG7575L70000 | Pan Head Screws (4) | FG757579YEL | 149 |
| FG7575L8BLA | WaveBrake® Gear and Rack Replacement | FG757588BLUE | 149 |
| FG7575L8BLA | WaveBrake® Gear and Rack Replacement | FG757588BRN | 149 |
| FG7575L8BLA | WaveBrake® Gear and Rack Replacement | FG757688YEL | 148 |
| FG7575L8BLA | WaveBrake® Gear and Rack Replacement | FG757788BRN | 146 |
| FG7575L8BLA | WaveBrake® Gear and Rack Replacement | FG757788YEL | 146 |
| FG7575L8BLA | WaveBrake® Gear and Rack Replacement | FG757888BLUE | 146 |
| FG7575L8BLA | WaveBrake® Gear and Rack Replacement | FG757888GRN | 146 |
| FG7575L8BLA | WaveBrake® Gear and Rack Replacement | FG757888RED | 146 |
| FG7806L8BLA | 3 Point Strap For High Chair | FG780508BLA | 314 |
| FG7806L8BLA | 3 Point Strap For High Chair | FG780508DGRN | 314 |
| FG7806L8BLA | 3 Point Strap For High Chair | FG780608BLA | 314 |
| FG7806L8BLA | 3 Point Strap For High Chair | FG780608DGRN | 314 |
| FG7806L8BLA | 3 Point Strap For High Chair | FG780608PLAT | 314 |
| FG7806L8BLA | 3 Point Strap For High Chair | FG781408BLA | 314 |
| FG7806L8BLA | 3 Point Strap For High Chair | FG781408DGRN | 314 |
| FG7806L8BLA | 3 Point Strap For High Chair | FG781408PLAT | 314 |
| FG7818L20000 | Safety Strap Kit | FG781888PLAT | 315 |
| FG7818L40000 | Baby Changing Station Horizontal Belt Kit | FG781888PLAT | 315 |
| FG7931L30000 | 6" Rigid Casters (2) | FG440300BLA | 323 |
| FG8170L1BEIG | Repleaceable Marshal Top with Hardware, Beige | FG817088BEIG | 72 |
| FG8170L1BEIG | Repleaceable Marshal Top with Hardware, Beige | FG817088BLA | 72 |
| FG8170L1BEIG | Repleaceable Marshal Top with Hardware, Beige | FG817088BRN | 72 |
| FG9054L2BLA | UBO Strap Replacement (2) | FG905800BLA | 72 |
| FG9054L2WGRAN | UBO Strap Replacement (2) | FG905886WGRAN | 72 |
| FG9171L4BLA | Base Ring | FG917188BEIG | 74 |
| FG9171L4BLA | Base Ring | FG917388BEIG | 74 |
| FG9171L4BLA | Base Ring | FG917388BLA | 74 |
| FG9171L4BLA | Base Ring | FG917500BEIG | 74 |
| FG9171L4BLA | Base Ring | FG917500BLA | 74 |
| FG9171L4BLA | Base Ring | FG917600BEIG | 74 |
| FG9171L4BLA | Base Ring | FG917600BLA | 74 |
| FG9511L2YEL | Middle Panel (2) | FG951100YEL | 211 |

| COMPONENT PART | COMPONENT DESCRIPTION | FITS | PAGE # (OF 'FITS' SKU) |
|----------------|-----------------------------------|--------------|------------------------|
| FG9T06L10000 | 16" Pneumatic Tire | FG130641BLA | 241 |
| FG9T06L10000 | 16" Pneumatic Tire | FG131641BLA | 241 |
| FG9T13L30000 | 10" Wheel | FG9T1300BLA | 239 |
| FG9T13L30000 | 10" Wheel | FG9T1700BLA | 240 |
| FG9T14L10000 | 10" Wheel | FG9T1400BLA | 239 |
| FG9T15L10000 | 5" Swivel Caster | FG9T1500BLA | 239 |
| FG9T15L10000 | 5" Swivel Caster | FG9T1500BLA | 239 |
| FG9T15L10000 | 5" Swivel Caster | FG9T1600BLA | 239 |
| FG9T15L10000 | 5" Swivel Caster | FG9T1600BLA | 239 |
| FG9T17L10000 | 4" Swivel Caster | FG9T1700BLA | 240 |
| FG9T18L10000 | 4" Swivel Caster | FG9T1800BLA | 240 |
| FG9T28L3BLA | 10ft Electrical Power Strip | FG9T3500BLA | 235 |
| FG9T57L2RED | Light Bulb Strap | FG9T5800BLA | 228 |
| FG9T57L5BLA | Strap For Ladder Cart | FG9T5800BLA | 228 |
| FG9T66L10000 | 5" Caster Kit | FG9T6600BLA | 230 |
| FG9T66L10000 | 5" Caster Kit | FG9T6700BLA | 230 |
| FG9T73L4BLA | Bottom Base | FG9T7200BLA | 193 |
| FG9T73L4BLA | Bottom Base | FG9T7300BLA | 192 |
| FG9T73L4BLA | Bottom Base | FG9T7400BLA | 192 |
| FG9T73L4BLA | Bottom Base | FG9T7500BLA | 192 |
| FG9T73L4BLA | Bottom Base | FG9T7800BLA | 195 |
| FG9T73L4BLA | Bottom Base | FG9T7900BLA | 193 |
| FG9T73L4BLA | Bottom Base | FG9T7900BLA | 193 |
| FG9T73L5BLA | Handle | FG9T7200BLA | 193 |
| FG9T73L5BLA | Handle | FG9T7300BLA | 192 |
| FG9T73L5BLA | Handle | FG9T7400BLA | 192 |
| FG9T73L5BLA | Handle | FG9T7500BLA | 192 |
| FG9T73L5BLA | Handle | FG9T7800BLA | 195 |
| FG9T73L5BLA | Handle | FG9T7900BLA | 193 |
| FG9T73L5BLA | Handle | FG9T7900BLA | 193 |
| FG9T73L60000 | Aluminum Uprights Kit | FG9T7200BLA | 193 |
| FG9T73L60000 | Aluminum Uprights Kit | FG9T7300BLA | 192 |
| FG9T73L60000 | Aluminum Uprights Kit | FG9T7400BLA | 192 |
| FG9T73L60000 | Aluminum Uprights Kit | FG9T7500BLA | 192 |
| FG9T73L60000 | Aluminum Uprights Kit | FG9T7800BLA | 195 |
| FG9T73L60000 | Aluminum Uprights Kit | FG9T7900BLA | 193 |
| FG9T73L60000 | Aluminum Uprights Kit | FG9T7900BLA | 193 |
| FG9T73L8BLA | Folding Bag/Bucket Platform | FG9T7300BLA | 192 |
| FG9T73L8BLA | Folding Bag/Bucket Platform | FG9T7400BLA | 192 |
| FG9T73L8BLA | Folding Bag/Bucket Platform | FG9T7500BLA | 192 |
| FG9T73L8BLA | Folding Bag/Bucket Platform | FG9T7800BLA | 195 |
| FG9T73L8BLA | Folding Bag/Bucket Platform | FG9T7900BLA | 193 |
| FG9T73L8BLA | Folding Bag/Bucket Platform | FG9T9200BLA | 194 |
| FG9T73L9GRAY | Wheel & Axle Parts | FG9T7200BLA | 193 |
| FG9T73L9GRAY | Wheel & Axle Parts | FG9T7300BLA | 192 |
| FG9T73L9GRAY | Wheel & Axle Parts | FG9T7800BLA | 195 |
| FG9T73M20000 | Lock And Key | FG9T7500BLA | 192 |
| FG9T73M20000 | Lock And Key | FG9T7800BLA | 195 |
| FG9T73M4BLA | Tool Grip Rack and Caps | FG9T7200BLA | 193 |
| FG9T73M4BLA | Tool Grip Rack and Caps | FG9T7300BLA | 192 |
| FG9T73M4BLA | Tool Grip Rack and Caps | FG9T7400BLA | 192 |
| FG9T73M4BLA | Tool Grip Rack and Caps | FG9T7500BLA | 192 |
| FG9T73M4BLA | Tool Grip Rack and Caps | FG9T7800BLA | 195 |
| FG9T73M5BLA | Rubber Tool Grip | FG9T7200BLA | 193 |
| FG9T73M5BLA | Rubber Tool Grip | FG9T7300BLA | 192 |
| FG9T73M5BLA | Rubber Tool Grip | FG9T7400BLA | 192 |
| FG9T73M5BLA | Rubber Tool Grip | FG9T7500BLA | 192 |
| FG9T73M5BLA | Rubber Tool Grip | FG9T7800BLA | 195 |
| FG9T73M6BLA | Handle Tool Grip Cap | FG9T7200BLA | 193 |
| FG9T73M6BLA | Handle Tool Grip Cap | FG9T7300BLA | 192 |
| FG9T73M6BLA | Handle Tool Grip Cap | FG9T7400BLA | 192 |
| FG9T73M6BLA | Handle Tool Grip Cap | FG9T7500BLA | 192 |
| FG9T73M6BLA | Handle Tool Grip Cap | FG9T7800BLA | 195 |
| FG9T73M6BLA | Handle Tool Grip Cap | FG9T7900BLA | 193 |
| FG9T73M6BLA | Handle Tool Grip Cap | FG9T7900BLA | 193 |
| FG9W04L3BLA | Squeegee for Window Wash | FG9W0400BLA | 77 |
| FG9W21L10000 | Wheel Set (2) | FG9W2100GRAY | 99 |
| FG9W21L2BLA | Replacement Rollout Axle Carriage | FG9W1188GRAY | 100 |
| FG9W21L2BLA | Replacement Rollout Axle Carriage | FG9W1900RED | 101 |

UTILITY AND RECYCLING REFUSE
DECORATIVE REFUSE
CLEANING
MATERIAL HANDLING
WASHROOM
FOODSERVICE
ACCESSORIES & INDEX



| COMPONENT PART | COMPONENT DESCRIPTION | FITS | PAGE # (OF 'FITS' SKU) |
|----------------|------------------------------------|----------------|---------------------------|
| FG9W21L2BLA | Replacement Rollout Axle Carriage | FG9W2000RED | |
| FG9W21L2BLA | Replacement Rollout Axle Carriage | FG9W2100GRAY | 99 |
| FG9W21L2BLA | Replacement Rollout Axle Carriage | FG9W2200GRAY | 99 |
| FG9W27L10000 | Replacement Wheels/Push Caps (2) | FG9W2700BLUE | 99 |
| FG9W27L10000 | Replacement Wheels/Push Caps (2) | FG9W2700GRAY | 99 |
| FG9W27L10000 | Replacement Wheels/Push Caps (2) | FG9W2700YEL | 99 |
| FG9W27L10000 | Replacement Wheels/Push Caps (2) | FG9W2773BLUE | 100 |
| FG9W27L2BLA | Replacement Lid/Handle | FG9W2700BLUE | 99 |
| FG9W27L2BLA | Replacement Lid/Handle | FG9W2700GRAY | 99 |
| FG9W27L2BLA | Replacement Lid/Handle | FG9W2700YEL | 99 |
| FG9W27L2BLA | Replacement Lid/Handle | FG9W2773BLUE | 100 |
| FG9W31L1BLA | Funnel Top Domed Cap | FG9W3100SSBLA | 82 |
| FG9W31L1BLA | Funnel Top Domed Cap | FG9W3200SSBLA | 82 |
| FG9W31L1BLA | Funnel Top Domed Cap | FG9W3300BLA | 82 |
| FG9W34L1AGBRNZ | Domed Cap | FG9W3400AGBRNZ | 82 |
| FG9W34L1AGBRNZ | Domed Cap | FG9W3400ATPWTR | 82 |
| FG9W34L1AGBRNZ | Domed Cap | FG9W3400BLA | 82 |
| FG9W71L1GRAY | 5" Caster Kit | FG9W7100BLA | |
| FG9W71L2BLA | 12" Wheel Kit | FG9W7100BLA | |
| FG9W71L5RED | Door Latch, Red | FG9W7100BLA | |
| FG9W71L6BLA | Doors With Latch, Black | FG9W7100BLA | |
| FG9W71L8BLA | Hinge Kit | FG9W7100BLA | |
| FG9W87L1YEL | BRUTE® Rim Caddy Bag Strap, Yellow | FG9W8700YEL | 95 |
| FGQ966L10000 | PULSE™ Caddy Connect | FGQ966000000 | 135 |
| FGQ969L10000 | PULSE™ Red Cap | 1835529 | 137 |
| FGQ969L10000 | PULSE™ Red Cap | FGQ966000000 | 135 |
| FGQ979L20000 | FLOW™ Clean Connect | FGQ98900YL00 | 142 |

UTILITY AND
RECYCLING REFUSE

DECORATIVE REFUSE

CLEANING

MATERIAL HANDLING

WASHROOM

FOODSERVICE

ACCESSORIES
& INDEX



© 2019 Rubbermaid Commercial Products LLC
8900 Northpointe Executive Drive, Huntersville, NC 28078
Visit rubbermaidcommercial.com for more information.

RCP1566 REV 06/19