



S H E L V I N G f o r L I F E[®]

Camshelving[®] Premium, Elements & Basics Plus Series



2021 Product Specification and Price List

CAMBRO
TRUSTED FOR GENERATIONS[™]

www.cambro.com

CAMSHELVING®

PREMIUM series | **ELEMENTS** series | **BASICS PLUS** series

Rust and Corrosion Free

Backed by a lifetime warranty against rust and corrosion, Camshelving storage systems eliminate the inconvenience and costs associated with restoring or replacing degraded shelving. Only Cambro offers Shelving for Life®.

Multi Environment Use

From freezers to coolers, ware washing or dry storage, Camshelving is designed to withstand all storage applications and temperatures—impervious to moisture, chemicals, salt, food acids, and humidity.

Easy to Clean

Cleaning shelving shouldn't be a major production. Whether daily or scheduled, cleaning can be done quickly and easily without interrupting storage space or normal, day-to-day operations.

Easy to Adjust & Assemble

Each shelf can be easily and independently adjusted to accommodate a variety of storage products and packages as product and storage needs change. Units ship in one box with pre-assembled post frames.

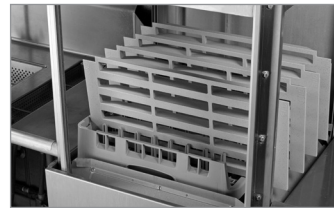
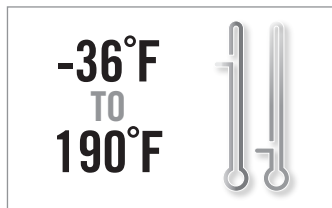

Maximized Space Utilization

Components have been thoughtfully designed to maximize storage space, even in space-restricted areas. Position shelves anywhere along the post, with dovetails spaced 4" apart.

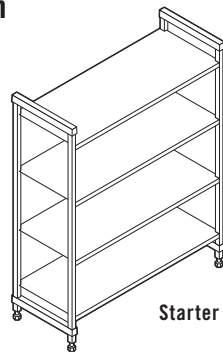

Starter Unit

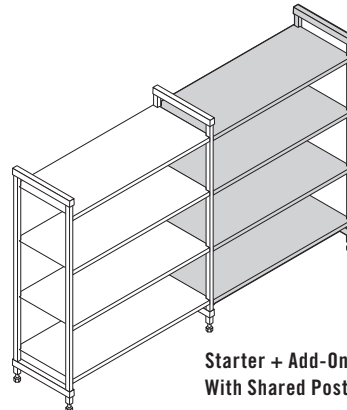

Starter + Add-On Unit With Shared Post

Shared Post

Space is money. Shelving units are designed to be interconnected, without compromising weight-bearing capacity all while maximizing usable storage space.

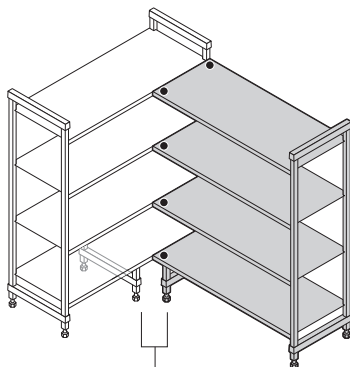

Corner Unit
Starter Unit + Add-On Unit using 1 set of Corner Connectors per shelf and 2 Dunnage Stands.

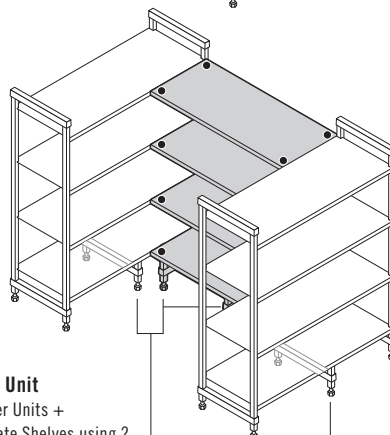

U-Shape Unit
Two Starter Units + Intermediate Shelves using 2 sets of Corner Connectors per shelf and 4 Dunnage Stands.

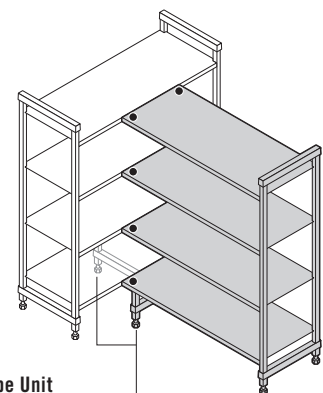

T-Shape Unit
Starter unit + Add-on unit using 1 set of corner connectors per shelf and 2 dunnage stands.

Corner Connectors ● = Corner Connectors

Convert unusable space into continuous, easy-access storage areas using corner connectors. (Corner connectors are for use only with shelves 24" - 48" long.)

Camshelving is covered under the following US Patents:

D498,664 S, D508,646 S, D512,867 S, D623,929 S, D624,764 S, D648,582 S, D630,935 S, D648,159 S, D651,433 S, D648,160 S, D697,391 S, D727,715 S, D728,347 S, D728,348 S, D707,994 S, D739,989 S, D663,912 S, D736,488 S, D739,989 S, US 6,981,454B2, D760,519 S.

CAMSHELVING® SERIES BUYERS GUIDE

All Camshelving lines offer a lifetime warranty against rust and corrosion for shelf plates, posts and traverses.



	PREMIUM series	ELEMENTS series	BASICS PLUS series
Shelf Depths	14", 18", 21", 24"	14", 18", 21", 24"	18", 21", 24"
Shelf Lengths	24", 30", 36", 42", 48", 54", 60", 72"	24", 30", 36", 42", 48", 54", 60", 72"	30", 36", 42", 48", 54", 60"
Post Heights	Stationary: 32", 56", 64", 72", 84" Mobile: 35", 59", 67", 75" (includes casters)	Stationary: 30", 64", 72", 84" Mobile: 27", 70", 78" (includes casters)	Stationary: 64", 72", 84"
Weight-Bearing Capacity (based on 24" - 48" length)	Stationary Unit: 800 lbs. per shelf, 2000 lbs. per unit. Mobile Unit: 750 lbs. per unit. Corner Unit: 400 lbs. per shelf, 1800 lbs. per unit.	Stationary Unit: 800 lbs. per shelf, 2000 lbs. per unit. Mobile Unit: 750 lbs. per unit. Corner Unit: 400 lbs. per shelf, 1800 lbs. per unit.	Stationary Unit: 600 lbs. per shelf, 1800 lbs. per unit. Corner Unit: 300 lbs. per shelf, 1350 lbs. per unit.
Shelf Plates	Interchangeable with Elements Series. Features Camguard® antimicrobial.	Interchangeable with Premium Series. Features Camguard antimicrobial.	Not interchangeable with Premium or Elements Series.
Mobility	Available in Mobile and High Density Storage System.	Available in Mobile.	Not available.
Assembly	Quickest and easiest to assemble due to molded-in dovetails.	Simple to assemble. Contains separate dovetails that must be attached to the post.	Simple to assemble. Contains separate dovetails that must be attached to the post.
ACCESSORIES			
Bottom Shelf Dunnage Stand	✓	✓	✓
Shelf Rails	✓	✓	✓
Vertical Drying and Storage Cradle (Trays / Cutting Boards / Lids)	✓	✓	✓
Dome Drying and Storage Cradle	✓	✓	✓
Angled Drying and Storage Cradle	✓	✓	✓
Ultimate #10 Can Rack	✓	✓	
Shelf Divider Panel	✓	✓	✓
Shelf Divider Bar (for Food Pans or Food Boxes)	✓	✓	
Single Shelf Sheet Pan/Tray Rack	✓	✓	✓
Single Shelf Security Cage	✓	✓	✓
Full Wrap Security Cage	✓		

CAMSHELVING® SERIES OVERALL LENGTH QUICK REFERENCE GUIDE

Straight Unit: Starter Unit + Add-On Unit with Shared Posts

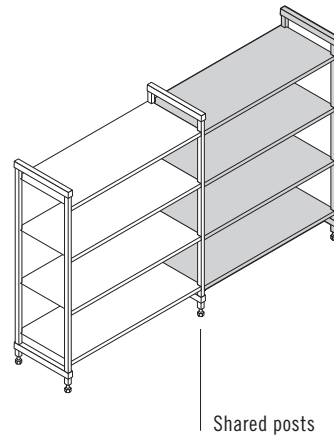
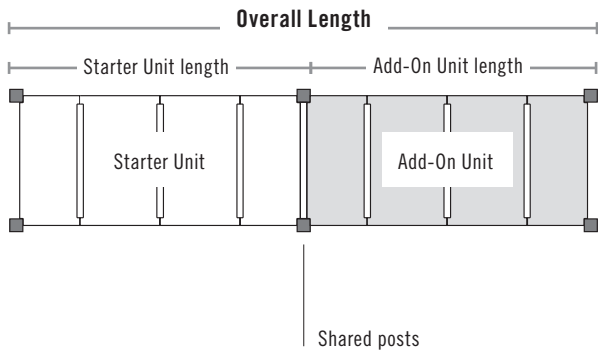

Corner Unit: Starter Unit + Add-On Unit with Corner Connectors

• = Corner Connectors

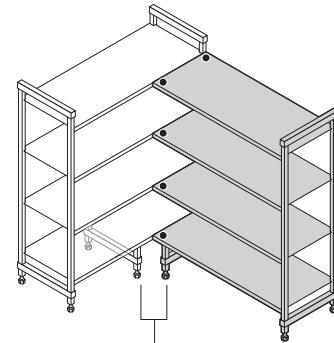
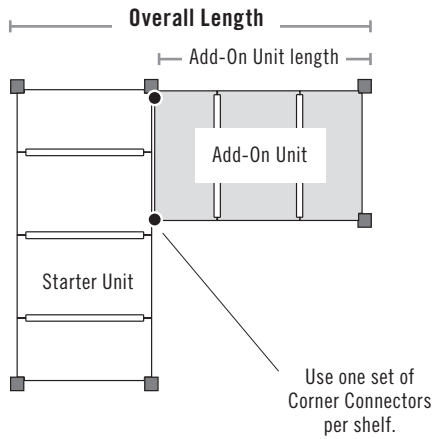

Use One Dunnage Stand under each Starter and Add-On Unit.

Corner Connectors are for use only with shelves 24" - 48" long.

U-Shape Unit: Two Starter Units + Intermediate Shelves with Corner Connectors

• = Corner Connectors

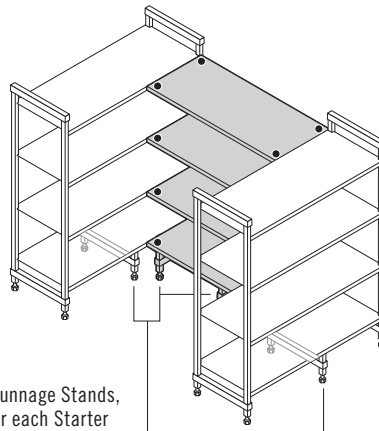
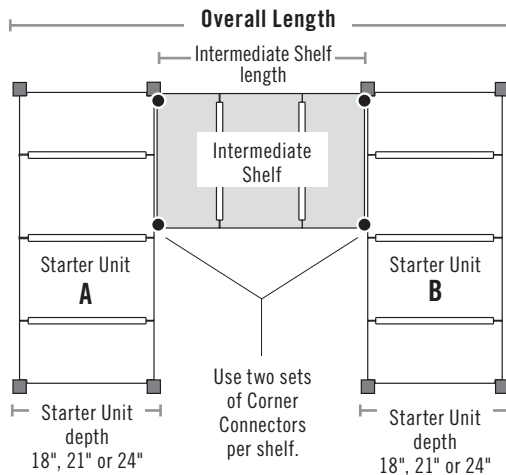

Use four Dunnage Stands, one under each Starter Unit and two under the bottom Intermediate Shelf.

Straight Unit: Starter Unit + Add-On Unit with Shared Posts

PREMIUM® / BASICS PLUS® SERIES				
STARTER & ADD-ON UNIT	STARTER UNIT ACTUAL LENGTH		ADD-ON UNIT ACTUAL LENGTH	OVERALL LENGTH
24"	24"	+	22¼"	= 46¼"
30"	30"	+	28¼"	= 58¼"
36"	36"	+	34¼"	= 70¼"
42"	42"	+	40¼"	= 82¼"
48"	48"	+	46¼"	= 94¼"
54"	54"	+	52¼"	= 106¼"
60"	60"	+	58¼"	= 118¼"
72"	72"	+	70¼"	= 142¼"

24" and 72" are not available in Camshelving Basics Plus Series.

ELEMENTS® SERIES				
STARTER UNIT ACTUAL LENGTH		ADD-ON UNIT ACTUAL LENGTH		OVERALL LENGTH
24"	+	22"	=	46"
30"	+	28"	=	58"
36"	+	34"	=	70"
42"	+	40"	=	82"
48"	+	46"	=	94"
54"	+	52"	=	106"
60"	+	58"	=	118"
72"	+	70"	=	142"

Corner Unit: Starter Unit + Add-On Unit with Corner Connectors

PREMIUM / ELEMENTS / BASICS PLUS SERIES				
ADD-ON UNIT	ADD-ON UNIT ACTUAL LENGTH		18" STARTER UNIT DEPTH	OVERALL LENGTH
24"	23"	+	18"	= 41"
30"	29"	+	18"	= 47"
36"	35"	+	18"	= 53"
42"	41"	+	18"	= 59"
48"	47"	+	18"	= 65"

24" unit not available in Camshelving Basics Plus Series.

PREMIUM / ELEMENTS / BASICS PLUS SERIES				
ADD-ON UNIT ACTUAL LENGTH		21" STARTER UNIT DEPTH		OVERALL LENGTH
23"	+	21"	=	44"
29"	+	21"	=	50"
35"	+	21"	=	56"
41"	+	21"	=	62"
47"	+	21"	=	68"

PREMIUM / ELEMENTS / BASICS PLUS SERIES				
ADD-ON UNIT ACTUAL LENGTH		24" STARTER UNIT DEPTH		OVERALL LENGTH
23"	+	24"	=	47"
29"	+	24"	=	53"
35"	+	24"	=	59"
41"	+	24"	=	65"
47"	+	24"	=	71"

U-Shape Unit: Two Starter Units + Intermediate Shelves with Corner Connectors

PREMIUM / ELEMENTS / BASICS PLUS SERIES				
INTERMEDIATE SHELF	INTERMEDIATE SHELF ACTUAL LENGTH		18" DEPTH STARTER UNIT A+B	OVERALL LENGTH
36"	34"	+	36"	= 70"
42"	40"	+	36"	= 76"
48"	46"	+	36"	= 82"

PREMIUM / ELEMENTS / BASICS PLUS SERIES				
INTERMEDIATE SHELF ACTUAL LENGTH		21" DEPTH STARTER UNIT A+B		OVERALL LENGTH
34"	+	42"	=	76"
40"	+	42"	=	82"
46"	+	42"	=	88"

PREMIUM / ELEMENTS / BASICS PLUS SERIES				
INTERMEDIATE SHELF ACTUAL LENGTH		24" DEPTH STARTER UNIT A+B		OVERALL LENGTH
34"	+	48"	=	82"
40"	+	48"	=	88"
46"	+	48"	=	94"

CAMSHELVING PREMIUM® AND ELEMENTS® SERIES SPACE REFERENCE GUIDE

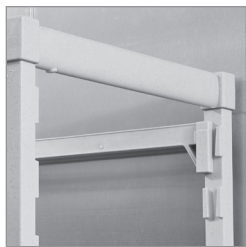
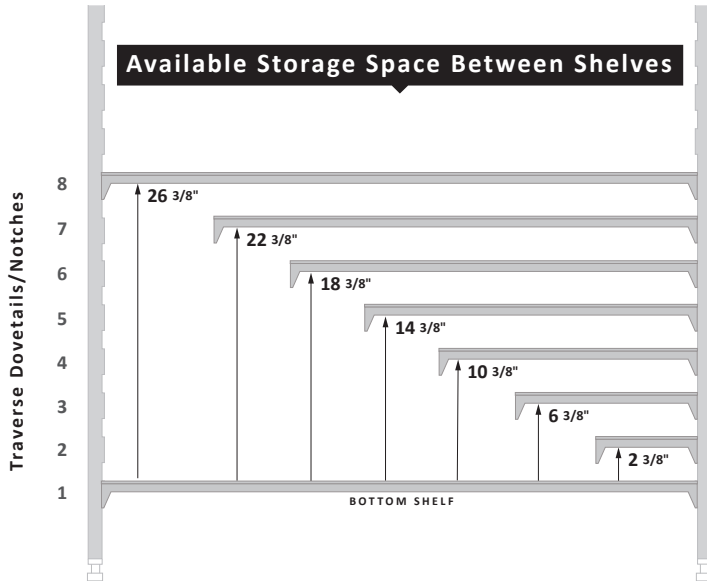
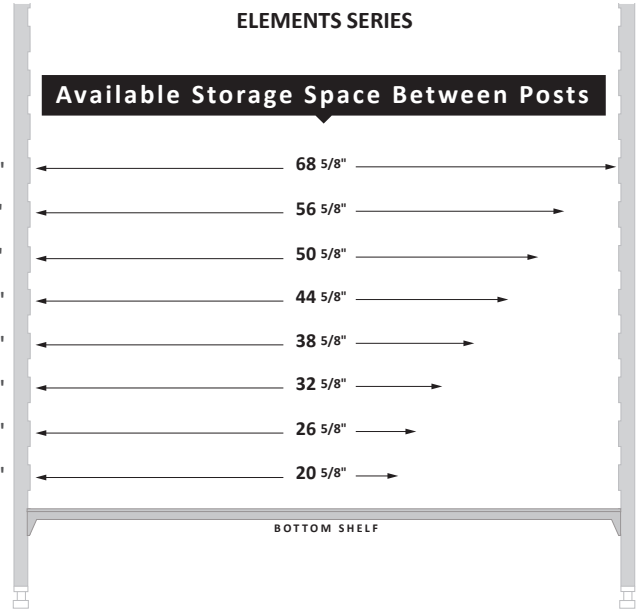
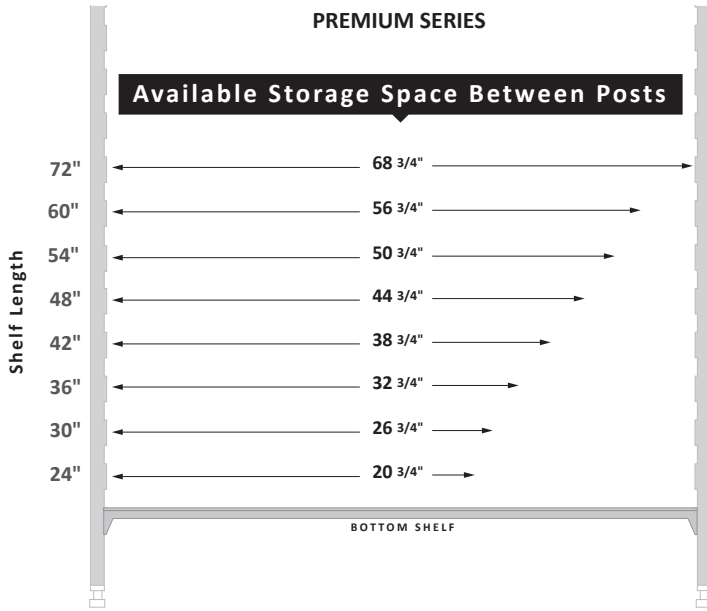

Traverse Dovetails

POST HEIGHT	NUMBER OF DOVETAILS PER POST*
STATIONARY UNIT	
30"	5
32"	6
56"	12
64"	14
72"	16
84"	19
MOBILE UNIT	
27"	3
35"	6
59"	12
67" or 70"	14
75" or 78"	16

*Also equals maximum number of shelves per unit.



CAMSHELVING BASICS® PLUS SERIES SPACE REFERENCE GUIDE

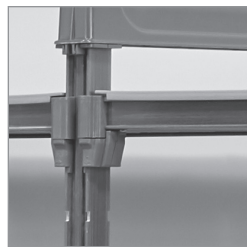
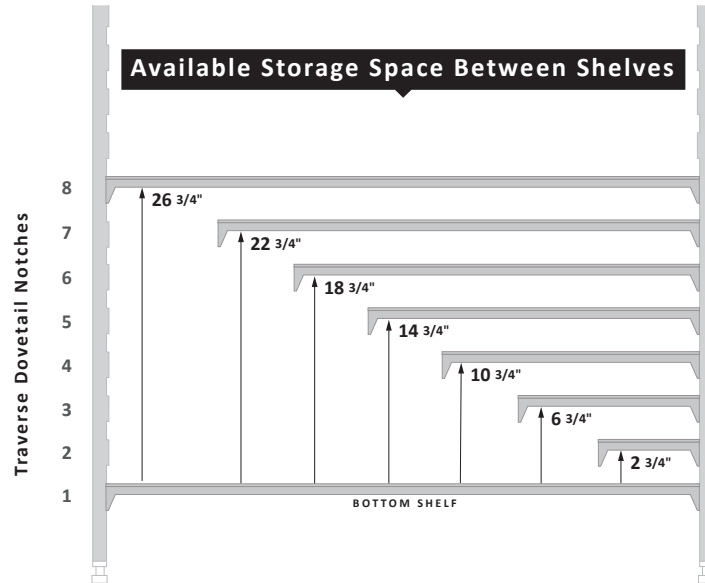
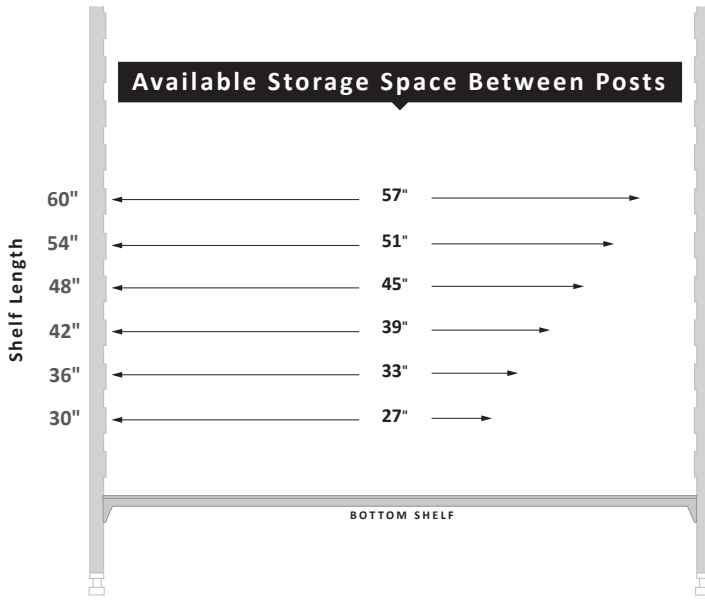

Traverse Dovetails

POST HEIGHT	NUMBER OF DOVETAILS PER POST*
64"	14
72"	16
84"	19

*Also equals maximum number of shelves per unit.



CAMSHELVING

PREMIUM[®]

series

STATIONARY | MOBILE | HIGH DENSITY

WHY CHOOSE PREMIUM?

In high volume foodservice operations with frequent deliveries and constant loading and off-loading of products, stability, strength and sanitary storage should never be compromised. Premium Series does precisely what it was designed to do – hold the heaviest products with the roughest handling, in any environment. It is also the easiest to clean and adjust.

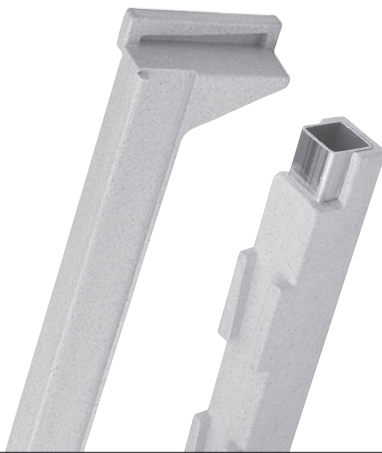

camguard.

ANTIMICROBIAL SHELF PLATES



Post Connectors, Corner Connectors, Floor Fastener, Wall Fastener, Identification Tags, Full Wrap Security Cage, Single Shelf Security Cage, Ultimate #10 Can Rack, Shelf Rails, Shelf Divider Bars, High Density Track and Extension Kits are not NSF Listed.

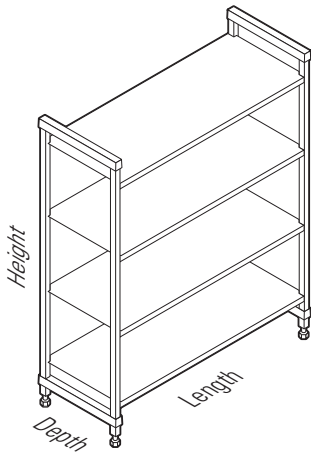

Stationary Unit Sizes

4 Depths		
14"	18"	21"
24"		
8 Lengths		
24"	30"	36"
42"	48"	54"
60"	72"	
5 Heights		
32"	56"	64"
72"	84"	

Mobile Unit Sizes

3 Depths		
18"	21"	24"
3 Lengths		
36"	42"	48"
4 Heights		
35"	59"	67"
75"		

High Density Unit Sizes

3 Depths		
18"	21"	24"
5 Lengths		
36"	42"	48"
54"	60"	
2 Heights		
67"	75"	

Weight Bearing Capacity

Weight must be evenly distributed across the entire shelf.

		UNIT LENGTH 24" – 48"	UNIT LENGTH 54" – 72"
SINGLE UNIT	Unit only	2,000 lbs.	2,000 lbs.
	Shelf only	800	600
	Unit with dunnage stand*	2,400	2,300
	Bottom shelf with dunnage stand*	1,200	900
CORNER UNIT*** With 2 Dunnage Stands required	Unit only	1,800	—
	Shelf only	400	—
	Bottom shelf with dunnage stands*	600	—
MOBILE UNIT	Unit only**	750	—

*Dunnage Stands add stability and increase weight bearing capacity on bottom shelf only. Highly recommended for Starter Units 54" and longer, all Corner Units, U-Shape Units and units specified for heavier loads. (See Overall Length Quick Reference Guide).

**Due to the weight bearing capacity of casters, maximum weight load on an entire Mobile Unit is 750 lbs.

***Corner connectors are for use only with shelves 24" - 48" long.



CAMSHELVING PREMIUM® SERIES – STARTER, ADD-ON AND MOBILE UNITS

V4 4-Shelf Vented Stationary Starter and Add-On Units

HEIGHTS	DEPTHS	LENGTHS
3	3	8
64"	18"	24" 48"
72"	21"	30" 54"
84"	24"	36" 60"
		42" 72"

V5 5-Shelf Vented Stationary Starter and Add-On Units

HEIGHTS	DEPTHS	LENGTHS
3	3	8
64"	18"	24" 48"
72"	21"	30" 54"
84"	24"	36" 60"
		42" 72"

S4 4-Shelf Solid Stationary Starter and Add-On Units

HEIGHTS	DEPTHS	LENGTHS
3	3	8
64"	18"	24" 48"
72"	21"	30" 54"
84"	24"	36" 60"
		42" 72"

S5 5-Shelf Solid Stationary Starter and Add-On Units

HEIGHT	DEPTHS	LENGTHS
1	3	8
84"	18"	24" 48"
	21"	30" 54"
	24"	36" 60"
		42" 72"

VS4 4-Shelf Vented and Solid Stationary Starter and Add-On Units (3 vented + 1 solid)

HEIGHTS	DEPTHS	LENGTHS
3	3	8
64"	18"	24" 48"
72"	21"	30" 54"
84"	24"	36" 60"
		42" 72"

VS5 5-Shelf Vented and Solid Stationary Starter and Add-On Units (4 vented + 1 solid)

HEIGHT	DEPTHS	LENGTHS
1	3	8
84"	18"	24" 48"
	21"	30" 54"
	24"	36" 60"
		42" 72"

V4 4-Shelf Vented Mobile Starter Units

HEIGHTS*	DEPTHS	LENGTHS
2	3	3
67"	18"	36"
75"	21"	42"
	24"	48"

*Includes 5" casters.

V5 5-Shelf Vented Mobile Starter Units

HEIGHTS*	DEPTHS	LENGTHS
2	3	3
67"	18"	36"
75"	21"	42"
	24"	48"

*Includes 5" casters.

V4

4-Shelf Vented Stationary Starter and Add-On Units

V5

5-Shelf Vented Stationary Starter and Add-On Units

Units ship complete in 1 box and include 1 or 2 factory assembled post kits, traverses and shelf plates.

NOTE: Due to unit weight, units 72" long and/or 84" high, ship in 2 or 3 separate boxes with 1 or 2 unassembled post kits and 1 box of 4 or 5 shelves. These products are identified with PKG in the code.

64"
HEIGHT

18"
DEPTH

Starter

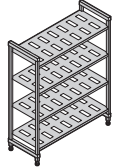

Add-On

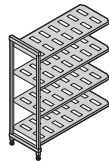

LENGTH	CODE	LIST PRICE EA.
24"	CPU182464V4	\$ 512.60
30"	CPU183064V4	579.60
36"	CPU183664V4	617.00
42"	CPU184264V4	692.00
48"	CPU184864V4	719.00
54"	CPU185464V4	793.40
60"	CPU186064V4	844.40
72"	CPU187264V4PKG	944.20

LENGTH	CODE	LIST PRICE EA.
22¼"	CPA182464V4	\$ 397.40
28¼"	CPA183064V4	464.40
34¼"	CPA183664V4	501.80
40¼"	CPA184264V4	576.80
46¼"	CPA184864V4	603.80
52¼"	CPA185464V4	678.20
58¼"	CPA186064V4	729.20
70¼"	CPA187264V4PKG	829.00

21"
DEPTH

24"	CPU212464V4	\$ 552.60
30"	CPU213064V4	628.40
36"	CPU213664V4	673.20
42"	CPU214264V4	758.40
48"	CPU214864V4	790.60
54"	CPU215464V4	875.40
60"	CPU216064V4	933.60
72"	CPU217264V4PKG	1,049.40

22¼"	CPA212464V4	\$ 434.40
28¼"	CPA213064V4	510.20
34¼"	CPA213664V4	555.00
40¼"	CPA214264V4	640.20
46¼"	CPA214864V4	672.40
52¼"	CPA215464V4	757.20
58¼"	CPA216064V4	815.40
70¼"	CPA217264V4PKG	931.20

24"
DEPTH

24"	CPU242464V4	\$ 561.60
30"	CPU243064V4	640.80
36"	CPU243664V4	691.20
42"	CPU244264V4	766.80
48"	CPU244864V4	817.00
54"	CPU245464V4	887.80
60"	CPU246064V4	940.00
72"	CPU247264V4PKG	1,064.80

22¼"	CPA242464V4	\$ 442.60
28¼"	CPA243064V4	521.80
34¼"	CPA243664V4	572.20
40¼"	CPA244264V4	647.80
46¼"	CPA244864V4	698.00
52¼"	CPA245464V4	768.80
58¼"	CPA246064V4	821.00
70¼"	CPA247264V4PKG	945.80

Starter

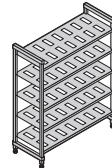

Add-On

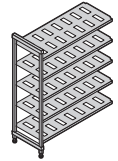

LENGTH	CODE	LIST PRICE EA.
24"	CPU182464V5	\$ 583.15
30"	CPU183064V5	666.90
36"	CPU183664V5	713.65
42"	CPU184264V5	807.40
48"	CPU184864V5	841.15
54"	CPU185464V5	934.15
60"	CPU186064V5	997.90
72"	CPU187264V5PKG	1,122.65

LENGTH	CODE	LIST PRICE EA.
22¼"	CPA182464V5	\$ 467.95
28¼"	CPA183064V5	551.70
34¼"	CPA183664V5	598.45
40¼"	CPA184264V5	692.20
46¼"	CPA184864V5	725.95
52¼"	CPA185464V5	818.95
58¼"	CPA186064V5	882.70
70¼"	CPA187264V5PKG	1,007.45

24"	CPU212464V5	\$ 631.65
30"	CPU213064V5	726.40
36"	CPU213664V5	782.40
42"	CPU214264V5	888.90
48"	CPU214864V5	929.15
54"	CPU215464V5	1,035.15
60"	CPU216064V5	1,107.90
72"	CPU217264V5PKG	1,252.65

22¼"	CPA212464V5	\$ 513.45
28¼"	CPA213064V5	608.20
34¼"	CPA213664V5	664.20
40¼"	CPA214264V5	770.70
46¼"	CPA214864V5	810.95
52¼"	CPA215464V5	916.95
58¼"	CPA216064V5	989.70
70¼"	CPA217264V5PKG	1,134.45

24"	CPU242464V5	\$ 642.50
30"	CPU243064V5	741.50
36"	CPU243664V5	804.50
42"	CPU244264V5	899.00
48"	CPU244864V5	961.75
54"	CPU245464V5	1,050.25
60"	CPU246064V5	1,115.50
72"	CPU247264V5PKG	1,271.50

22¼"	CPA242464V5	\$ 523.50
28¼"	CPA243064V5	622.50
34¼"	CPA243664V5	685.50
40¼"	CPA244264V5	780.00
46¼"	CPA244864V5	842.75
52¼"	CPA245464V5	931.25
58¼"	CPA246064V5	996.50
70¼"	CPA247264V5PKG	1,152.50

Color: Speckled Gray (480).

S4

4-Shelf Solid Stationary Starter and Add-On Units

VS4

4-Shelf Vented and Solid Stationary Starter and Add-On Units

(3 Vented + 1 Solid)

Units ship complete in 1 box and include 1 or 2 factory assembled post kits, traverses and shelf plates.

NOTE: Due to unit weight, units 72" long and/or 84" high, ship in 2 or 3 separate boxes with 1 or 2 unassembled post kits and 1 box of 4 or 5 shelves. These products are identified with PKG in the code.

64"
HEIGHT

Starter

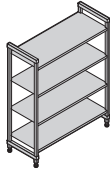

Add-On

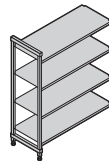

18"
DEPTH

LENGTH	CODE	LIST PRICE EA.
24"	CPU182464S4	\$ 526.40
30"	CPU183064S4	594.60
36"	CPU183664S4	635.40
42"	CPU184264S4	715.20
48"	CPU184864S4	741.20
54"	CPU185464S4	821.40
60"	CPU186064S4	877.60
72"	CPU187264S4PKG	981.20

LENGTH	CODE	LIST PRICE EA.
22¼"	CPA182464S4	\$ 411.20
28¾"	CPA183064S4	479.40
34¼"	CPA183664S4	520.20
40¼"	CPA184264S4	600.00
46¼"	CPA184864S4	626.00
52¼"	CPA185464S4	706.20
58¼"	CPA186064S4	762.40
70¼"	CPA187264S4PKG	866.00

Starter

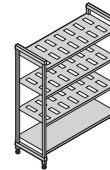

Add-On

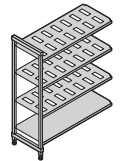

LENGTH	CODE	LIST PRICE EA.
24"	CPU182464VS4	\$ 516.05
30"	CPU183064VS4	583.35
36"	CPU183664VS4	621.60
42"	CPU184264VS4	697.80
48"	CPU184864VS4	724.55
54"	CPU185464VS4	800.40
60"	CPU186064VS4	852.70
72"	CPU187264VS4PKG	953.45

LENGTH	CODE	LIST PRICE EA.
22¼"	CPA182464VS4	\$ 400.85
28¾"	CPA183064VS4	468.15
34¼"	CPA183664VS4	506.40
40¼"	CPA184264VS4	582.60
46¼"	CPA184864VS4	609.35
52¼"	CPA185464VS4	685.20
58¼"	CPA186064VS4	737.50
70¼"	CPA187264VS4PKG	838.25

21"
DEPTH

24"	CPU212464S4	\$ 565.60
30"	CPU213064S4	648.40
36"	CPU213664S4	696.80
42"	CPU214264S4	783.80
48"	CPU214864S4	825.20
54"	CPU215464S4	911.40
60"	CPU216064S4	971.40
72"	CPU217264S4PKG	1,097.80

22¼"	CPA212464S4	\$ 447.40
28¾"	CPA213064S4	530.20
34¼"	CPA213664S4	578.60
40¼"	CPA214264S4	665.60
46¼"	CPA214864S4	707.00
52¼"	CPA215464S4	793.20
58¼"	CPA216064S4	853.20
70¼"	CPA217264S4PKG	979.60

24"	CPU212464VS4	\$ 555.85
30"	CPU213064VS4	633.40
36"	CPU213664VS4	679.10
42"	CPU214264VS4	764.75
48"	CPU214864VS4	799.25
54"	CPU215464VS4	884.40
60"	CPU216064VS4	943.05
72"	CPU217264VS4PKG	1,061.50

22¼"	CPA212464VS4	\$ 437.65
28¾"	CPA213064VS4	515.20
34¼"	CPA213664VS4	560.90
40¼"	CPA214264VS4	646.55
46¼"	CPA214864VS4	681.05
52¼"	CPA215464VS4	766.20
58¼"	CPA216064VS4	824.85
70¼"	CPA217264VS4PKG	943.30

24"
DEPTH

24"	CPU242464S4	\$ 588.40
30"	CPU243064S4	670.80
36"	CPU243664S4	724.00
42"	CPU244264S4	800.60
48"	CPU244864S4	854.60
54"	CPU245464S4	932.00
60"	CPU246064S4	990.60
72"	CPU247264S4PKG	1,120.20

22¼"	CPA242464S4	\$ 469.40
28¾"	CPA243064S4	551.80
34¼"	CPA243664S4	605.00
40¼"	CPA244264S4	681.60
46¼"	CPA244864S4	735.60
52¼"	CPA245464S4	813.00
58¼"	CPA246064S4	871.60
70¼"	CPA247264S4PKG	1,001.20

24"	CPU242464VS4	\$ 568.30
30"	CPU243064VS4	648.30
36"	CPU243664VS4	699.40
42"	CPU244264VS4	775.25
48"	CPU244864VS4	826.40
54"	CPU245464VS4	898.85
60"	CPU246064VS4	952.65
72"	CPU247264VS4PKG	1,078.65

22¼"	CPA242464VS4	\$ 449.30
28¾"	CPA243064VS4	529.30
34¼"	CPA243664VS4	580.40
40¼"	CPA244264VS4	656.25
46¼"	CPA244864VS4	707.40
52¼"	CPA245464VS4	779.85
58¼"	CPA246064VS4	833.65
70¼"	CPA247264VS4PKG	959.65

Color: Speckled Gray (480).

V4

4-Shelf Vented Stationary Starter and Add-On Units

V5

5-Shelf Vented Stationary Starter and Add-On Units

Units ship complete in 1 box and include 1 or 2 factory assembled post kits, traverses and shelf plates.

NOTE: Due to unit weight, units 72" long and/or 84" high, ship in 2 or 3 separate boxes with 1 or 2 unassembled post kits and 1 box of 4 or 5 shelves. These products are identified with PKG in the code.

72"
HEIGHT

18"
DEPTH

Starter

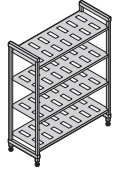

Add-On

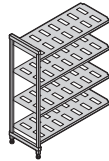

LENGTH	CODE	LIST PRICE EA.
24"	CPU182472V4	\$ 517.70
30"	CPU183072V4	584.70
36"	CPU183672V4	622.10
42"	CPU184272V4	697.10
48"	CPU184872V4	724.10
54"	CPU185472V4	798.50
60"	CPU186072V4	849.50
72"	CPU187272V4PKG	949.30

LENGTH	CODE	LIST PRICE EA.
22¼"	CPA182472V4	\$ 399.95
28¾"	CPA183072V4	466.95
34¼"	CPA183672V4	504.35
40¼"	CPA184272V4	579.35
46¼"	CPA184872V4	606.35
52¼"	CPA185472V4	680.75
58¼"	CPA186072V4	731.75
70¼"	CPA187272V4PKG	831.55

Starter

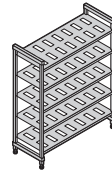

Add-On

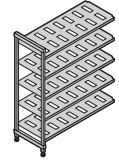

LENGTH	CODE	LIST PRICE EA.
24"	CPU182472V5	\$ 588.25
30"	CPU183072V5	672.00
36"	CPU183672V5	718.75
42"	CPU184272V5	812.50
48"	CPU184872V5	846.25
54"	CPU185472V5	939.25
60"	CPU186072V5	1,003.00
72"	CPU187272V5PKG	1,127.75

LENGTH	CODE	LIST PRICE EA.
22¼"	CPA182472V5	\$ 470.50
28¾"	CPA183072V5	554.25
34¼"	CPA183672V5	601.00
40¼"	CPA184272V5	694.75
46¼"	CPA184872V5	728.50
52¼"	CPA185472V5	821.50
58¼"	CPA186072V5	885.25
70¼"	CPA187272V5PKG	1,010.00

21"
DEPTH

24"	CPU212472V4	\$ 557.30
30"	CPU213072V4	633.10
36"	CPU213672V4	677.90
42"	CPU214272V4	763.10
48"	CPU214872V4	795.30
54"	CPU215472V4	880.10
60"	CPU216072V4	938.30
72"	CPU217272V4PKG	1,054.10

22¼"	CPA212472V4	\$ 436.75
28¾"	CPA213072V4	512.55
34¼"	CPA213672V4	557.35
40¼"	CPA214272V4	642.55
46¼"	CPA214872V4	674.75
52¼"	CPA215472V4	759.55
58¼"	CPA216072V4	817.75
70¼"	CPA217272V4PKG	933.55

24"	CPU212472V5	\$ 636.35
30"	CPU213072V5	731.10
36"	CPU213672V5	787.10
42"	CPU214272V5	893.60
48"	CPU214872V5	933.85
54"	CPU215472V5	1,039.85
60"	CPU216072V5	1,112.60
72"	CPU217272V5PKG	1,257.35

22¼"	CPA212472V5	\$ 515.80
28¾"	CPA213072V5	610.55
34¼"	CPA213672V5	666.55
40¼"	CPA214272V5	773.05
46¼"	CPA214872V5	813.30
52¼"	CPA215472V5	919.30
58¼"	CPA216072V5	992.05
70¼"	CPA217272V5PKG	1,136.80

24"
DEPTH

24"	CPU242472V4	\$ 567.00
30"	CPU243072V4	646.20
36"	CPU243672V4	696.60
42"	CPU244272V4	772.20
48"	CPU244872V4	822.40
54"	CPU245472V4	893.20
60"	CPU246072V4	945.40
72"	CPU247272V4PKG	1,070.20

22¼"	CPA242472V4	\$ 445.30
28¾"	CPA243072V4	524.50
34¼"	CPA243672V4	574.90
40¼"	CPA244272V4	650.50
46¼"	CPA244872V4	700.70
52¼"	CPA245472V4	771.50
58¼"	CPA246072V4	823.70
70¼"	CPA247272V4PKG	948.50

24"	CPU242472V5	\$ 647.90
30"	CPU243072V5	746.90
36"	CPU243672V5	809.90
42"	CPU244272V5	904.40
48"	CPU244872V5	967.15
54"	CPU245472V5	1,055.65
60"	CPU246072V5	1,120.90
72"	CPU247272V5PKG	1,276.90

22¼"	CPA242472V5	\$ 526.20
28¾"	CPA243072V5	625.20
34¼"	CPA243672V5	688.20
40¼"	CPA244272V5	782.70
46¼"	CPA244872V5	845.45
52¼"	CPA245472V5	933.95
58¼"	CPA246072V5	999.20
70¼"	CPA247272V5PKG	1,155.20

Color: Speckled Gray (480).

S4

4-Shelf Solid Stationary Starter and Add-On Units

VS4

4-Shelf Vented and Solid Stationary Starter and Add-On Units

(3 Vented + 1 Solid)

Units ship complete in 1 box and include 1 or 2 factory assembled post kits, traverses and shelf plates.

NOTE: Due to unit weight, units 72" long and/or 84" high, ship in 2 or 3 separate boxes with 1 or 2 unassembled post kits and 1 box of 4 or 5 shelves. These products are identified with PKG in the code.

72"
HEIGHT

Starter

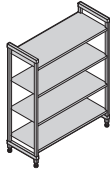

Add-On

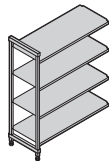

18"
DEPTH

LENGTH	CODE	LIST PRICE EA.
24"	CPU182472S4	\$ 531.50
30"	CPU183072S4	599.70
36"	CPU183672S4	640.50
42"	CPU184272S4	720.30
48"	CPU184872S4	746.30
54"	CPU185472S4	826.50
60"	CPU186072S4	882.70
72"	CPU187272S4PKG	986.30

LENGTH	CODE	LIST PRICE EA.
22¼"	CPA182472S4	\$ 413.75
28¾"	CPA183072S4	481.95
34¼"	CPA183672S4	522.75
40¼"	CPA184272S4	602.55
46¼"	CPA184872S4	628.55
52¼"	CPA185472S4	708.75
58¼"	CPA186072S4	764.95
70¼"	CPA187272S4PKG	868.55

Starter

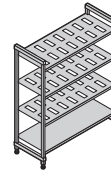

Add-On

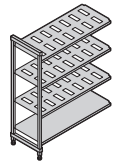

LENGTH	CODE	LIST PRICE EA.
24"	CPU182472VS4	\$ 521.15
30"	CPU183072VS4	588.45
36"	CPU183672VS4	626.70
42"	CPU184272VS4	702.90
48"	CPU184872VS4	729.65
54"	CPU185472VS4	805.50
60"	CPU186072VS4	857.80
72"	CPU187272VS4PKG	958.55

LENGTH	CODE	LIST PRICE EA.
22¼"	CPA182472VS4	\$ 403.40
28¾"	CPA183072VS4	470.70
34¼"	CPA183672VS4	508.95
40¼"	CPA184272VS4	585.15
46¼"	CPA184872VS4	611.90
52¼"	CPA185472VS4	687.75
58¼"	CPA186072VS4	740.05
70¼"	CPA187272VS4PKG	840.80

21"
DEPTH

24"	CPU212472S4	\$ 570.30
30"	CPU213072S4	653.10
36"	CPU213672S4	701.50
42"	CPU214272S4	788.50
48"	CPU214872S4	829.90
54"	CPU215472S4	916.10
60"	CPU216072S4	976.10
72"	CPU217272S4PKG	1,102.50

22¼"	CPA212472S4	\$ 449.75
28¾"	CPA213072S4	532.55
34¼"	CPA213672S4	580.95
40¼"	CPA214272S4	667.95
46¼"	CPA214872S4	709.35
52¼"	CPA215472S4	795.55
58¼"	CPA216072S4	855.55
70¼"	CPA217272S4PKG	981.95

24"	CPU212472VS4	\$ 560.55
30"	CPU213072VS4	638.10
36"	CPU213672VS4	683.80
42"	CPU214272VS4	769.45
48"	CPU214872VS4	803.95
54"	CPU215472VS4	889.10
60"	CPU216072VS4	947.75
72"	CPU217272VS4PKG	1,066.20

22¼"	CPA212472VS4	\$ 440.00
28¾"	CPA213072VS4	517.55
34¼"	CPA213672VS4	563.25
40¼"	CPA214272VS4	648.90
46¼"	CPA214872VS4	683.40
52¼"	CPA215472VS4	768.55
58¼"	CPA216072VS4	827.20
70¼"	CPA217272VS4PKG	945.65

24"
DEPTH

24"	CPU242472S4	\$ 593.80
30"	CPU243072S4	676.20
36"	CPU243672S4	729.40
42"	CPU244272S4	806.00
48"	CPU244872S4	860.00
54"	CPU245472S4	937.40
60"	CPU246072S4	996.00
72"	CPU247272S4PKG	1,125.60

22¼"	CPA242472S4	\$ 472.10
28¾"	CPA243072S4	554.50
34¼"	CPA243672S4	607.70
40¼"	CPA244272S4	684.30
46¼"	CPA244872S4	738.30
52¼"	CPA245472S4	815.70
58¼"	CPA246072S4	874.30
70¼"	CPA247272S4PKG	1,003.90

24"	CPU242472VS4	\$ 573.70
30"	CPU243072VS4	653.70
36"	CPU243672VS4	704.80
42"	CPU244272VS4	780.65
48"	CPU244872VS4	831.80
54"	CPU245472VS4	904.25
60"	CPU246072VS4	958.05
72"	CPU247272VS4PKG	1,084.05

22¼"	CPA242472VS4	\$ 452.00
28¾"	CPA243072VS4	532.00
34¼"	CPA243672VS4	583.10
40¼"	CPA244272VS4	658.95
46¼"	CPA244872VS4	710.10
52¼"	CPA245472VS4	782.55
58¼"	CPA246072VS4	836.35
70¼"	CPA247272VS4PKG	962.35

Color: Speckled Gray (480).

V4PKG

4-Shelf Vented Stationary Starter and Add-On Units

V5PKG

5-Shelf Vented Stationary Starter and Add-On Units

Units ship in 2 or 3 separate boxes with 1 or 2 unassembled post kits and 1 box of 4 or 5 shelves.

84"
HEIGHT

18"
DEPTH

Starter

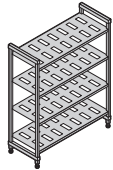

Add-On

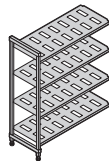

LENGTH	CODE	LIST PRICE EA.
24"	CPU182484V4PKG	\$ 554.30
30"	CPU183084V4PKG	621.30
36"	CPU183684V4PKG	658.70
42"	CPU184284V4PKG	733.70
48"	CPU184884V4PKG	760.70
54"	CPU185484V4PKG	835.10
60"	CPU186084V4PKG	886.10
72"	CPU187284V4PKG	985.90

LENGTH	CODE	LIST PRICE EA.
22¼"	CPA182484V4PKG	\$ 418.25
28¼"	CPA183084V4PKG	485.25
34¼"	CPA183684V4PKG	522.65
40¼"	CPA184284V4PKG	597.65
46¼"	CPA184884V4PKG	624.65
52¼"	CPA185484V4PKG	699.05
58¼"	CPA186084V4PKG	750.05
70¼"	CPA187284V4PKG	849.85

Starter

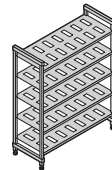

Add-On

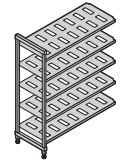

LENGTH	CODE	LIST PRICE EA.
24"	CPU182484V5PKG	\$ 624.85
30"	CPU183084V5PKG	708.60
36"	CPU183684V5PKG	755.35
42"	CPU184284V5PKG	849.10
48"	CPU184884V5PKG	882.85
54"	CPU185484V5PKG	975.85
60"	CPU186084V5PKG	1,039.60
72"	CPU187284V5PKG	1,164.35

LENGTH	CODE	LIST PRICE EA.
22¼"	CPA182484V5PKG	\$ 488.80
28¼"	CPA183084V5PKG	572.55
34¼"	CPA183684V5PKG	619.30
40¼"	CPA184284V5PKG	713.05
46¼"	CPA184884V5PKG	746.80
52¼"	CPA185484V5PKG	839.80
58¼"	CPA186084V5PKG	903.55
70¼"	CPA187284V5PKG	1,028.30

21"
DEPTH

24"	CPU212484V4PKG	\$ 593.90
30"	CPU213084V4PKG	669.70
36"	CPU213684V4PKG	714.50
42"	CPU214284V4PKG	799.70
48"	CPU214884V4PKG	831.90
54"	CPU215484V4PKG	916.70
60"	CPU216084V4PKG	974.90
72"	CPU217284V4PKG	1,090.70

22¼"	CPA212484V4PKG	\$ 455.05
28¼"	CPA213084V4PKG	530.85
34¼"	CPA213684V4PKG	593.15
40¼"	CPA214284V4PKG	660.85
46¼"	CPA214884V4PKG	693.05
52¼"	CPA215484V4PKG	777.85
58¼"	CPA216084V4PKG	836.05
70¼"	CPA217284V4PKG	951.85

24"	CPU212484V5PKG	\$ 672.95
30"	CPU213084V5PKG	767.70
36"	CPU213684V5PKG	823.70
42"	CPU214284V5PKG	930.20
48"	CPU214884V5PKG	970.45
54"	CPU215484V5PKG	1,076.45
60"	CPU216084V5PKG	1,149.20
72"	CPU217284V5PKG	1,293.95

22¼"	CPA212484V5PKG	\$ 534.10
28¼"	CPA213084V5PKG	628.85
34¼"	CPA213684V5PKG	684.85
40¼"	CPA214284V5PKG	791.35
46¼"	CPA214884V5PKG	831.60
52¼"	CPA215484V5PKG	937.60
58¼"	CPA216084V5PKG	1,010.35
70¼"	CPA217284V5PKG	1,155.10

24"
DEPTH

24"	CPU242484V4PKG	\$ 603.50
30"	CPU243084V4PKG	682.70
36"	CPU243684V4PKG	733.10
42"	CPU244284V4PKG	808.70
48"	CPU244884V4PKG	858.90
54"	CPU245484V4PKG	929.70
60"	CPU246084V4PKG	981.90
72"	CPU247284V4PKG	1,106.70

22¼"	CPA242484V4PKG	\$ 463.55
28¼"	CPA243084V4PKG	542.75
34¼"	CPA243684V4PKG	593.15
40¼"	CPA244284V4PKG	668.75
46¼"	CPA244884V4PKG	718.95
52¼"	CPA245484V4PKG	789.75
58¼"	CPA246084V4PKG	841.95
70¼"	CPA247284V4PKG	966.75

24"	CPU242484V5PKG	\$ 684.40
30"	CPU243084V5PKG	783.40
36"	CPU243684V5PKG	846.40
42"	CPU244284V5PKG	940.90
48"	CPU244884V5PKG	1,003.65
54"	CPU245484V5PKG	1,092.15
60"	CPU246084V5PKG	1,157.40
72"	CPU247284V5PKG	1,313.40

22¼"	CPA242484V5PKG	\$ 544.45
28¼"	CPA243084V5PKG	643.45
34¼"	CPA243684V5PKG	706.45
40¼"	CPA244284V5PKG	800.95
46¼"	CPA244884V5PKG	863.70
52¼"	CPA245484V5PKG	952.20
58¼"	CPA246084V5PKG	1,017.45
70¼"	CPA247284V5PKG	1,173.45

Color: Speckled Gray (480).

S4PKG

4-Shelf Solid Stationary Starter and Add-On Units

S5PKG

5-Shelf Solid Stationary Starter and Add-On Units

Units ship in 2 or 3 separate boxes with 1 or 2 unassembled post kits and
1 box of 4 or 5 shelves.

84"
HEIGHT

Starter

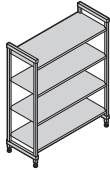

Add-On

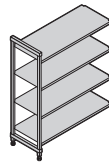

18"
DEPTH

LENGTH	CODE	LIST PRICE EA.
24"	CPU182484S4PKG	\$ 568.10
30"	CPU183084S4PKG	636.30
36"	CPU183684S4PKG	677.10
42"	CPU184284S4PKG	756.90
48"	CPU184884S4PKG	782.90
54"	CPU185484S4PKG	863.10
60"	CPU186084S4PKG	919.30
72"	CPU187284S4PKG	1,022.90

LENGTH	CODE	LIST PRICE EA.
22¼"	CPA182484S4PKG	\$ 432.05
28¾"	CPA183084S4PKG	500.25
34¼"	CPA183684S4PKG	541.05
40¼"	CPA184284S4PKG	620.85
46¼"	CPA184884S4PKG	646.85
52¼"	CPA185484S4PKG	727.05
58¼"	CPA186084S4PKG	783.25
70¼"	CPA187284S4PKG	886.85

Starter

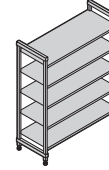

Add-On

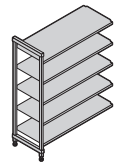

LENGTH	CODE	LIST PRICE EA.
24"	CPU182484S5PKG	\$ 642.10
30"	CPU183084S5PKG	727.35
36"	CPU183684S5PKG	778.35
42"	CPU184284S5PKG	878.10
48"	CPU184884S5PKG	910.60
54"	CPU185484S5PKG	1,010.85
60"	CPU186084S5PKG	1,081.10
72"	CPU187284S5PKG	1,210.60

LENGTH	CODE	LIST PRICE EA.
22¼"	CPA182484S5PKG	\$ 506.05
28¾"	CPA183084S5PKG	591.30
34¼"	CPA183684S5PKG	642.30
40¼"	CPA184284S5PKG	742.05
46¼"	CPA184884S5PKG	774.55
52¼"	CPA185484S5PKG	874.80
58¼"	CPA186084S5PKG	945.05
70¼"	CPA187284S5PKG	1,074.55

21"
DEPTH

24"	CPU212484S4PKG	\$ 606.90
30"	CPU213084S4PKG	689.70
36"	CPU213684S4PKG	738.10
42"	CPU214284S4PKG	825.10
48"	CPU214884S4PKG	866.50
54"	CPU215484S4PKG	952.70
60"	CPU216084S4PKG	1,012.70
72"	CPU217284S4PKG	1,139.10

22¼"	CPA212484S4PKG	\$ 468.05
28¾"	CPA213084S4PKG	550.85
34¼"	CPA213684S4PKG	599.25
40¼"	CPA214284S4PKG	686.25
46¼"	CPA214884S4PKG	727.65
52¼"	CPA215484S4PKG	813.85
58¼"	CPA216084S4PKG	873.85
70¼"	CPA217284S4PKG	1,000.25

24"	CPU212484S5PKG	\$ 689.20
30"	CPU213084S5PKG	792.70
36"	CPU213684S5PKG	853.20
42"	CPU214284S5PKG	961.95
48"	CPU214884S5PKG	1,013.70
54"	CPU215484S5PKG	1,121.45
60"	CPU216084S5PKG	1,196.45
72"	CPU217284S5PKG	1,354.45

22¼"	CPA212484S5PKG	\$ 550.35
28¾"	CPA213084S5PKG	653.85
34¼"	CPA213684S5PKG	714.35
40¼"	CPA214284S5PKG	823.10
46¼"	CPA214884S5PKG	874.85
52¼"	CPA215484S5PKG	982.60
58¼"	CPA216084S5PKG	1,057.60
70¼"	CPA217284S5PKG	1,215.60

24"
DEPTH

24"	CPU242484S4PKG	\$ 630.30
30"	CPU243084S4PKG	712.70
36"	CPU243684S4PKG	765.90
42"	CPU244284S4PKG	842.50
48"	CPU244884S4PKG	896.50
54"	CPU245484S4PKG	973.90
60"	CPU246084S4PKG	1,032.50
72"	CPU247284S4PKG	1,162.10

22¼"	CPA242484S4PKG	\$ 490.35
28¾"	CPA243084S4PKG	572.75
34¼"	CPA243684S4PKG	625.95
40¼"	CPA244284S4PKG	702.55
46¼"	CPA244884S4PKG	756.55
52¼"	CPA245484S4PKG	833.95
58¼"	CPA246084S4PKG	892.55
70¼"	CPA247284S4PKG	1,022.15

24"	CPU242484S5PKG	\$ 717.90
30"	CPU243084S5PKG	820.90
36"	CPU243684S5PKG	887.40
42"	CPU244284S5PKG	983.15
48"	CPU244884S5PKG	1,050.65
54"	CPU245484S5PKG	1,147.40
60"	CPU246084S5PKG	1,220.65
72"	CPU247284S5PKG	1,382.65

22¼"	CPA242484S5PKG	\$ 577.95
28¾"	CPA243084S5PKG	680.95
34¼"	CPA243684S5PKG	747.45
40¼"	CPA244284S5PKG	843.20
46¼"	CPA244884S5PKG	910.70
52¼"	CPA245484S5PKG	1,007.45
58¼"	CPA246084S5PKG	1,080.70
70¼"	CPA247284S5PKG	1,242.70

Color: Speckled Gray (480).

VS4PKG

4-Shelf Vented and Solid Stationary Starter and Add-On Units

(3 vented + 1 solid)

VS5PKG

5-Shelf Vented and Solid Stationary Starter and Add-On Units

(4 vented + 1 solid)

Units ship in 2 or 3 separate boxes with 1 or 2 unassembled post kits and 1 box of 4 or 5 shelves.

84"
HEIGHT

18"
DEPTH

Starter

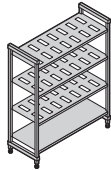

Add-On

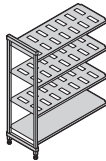

LENGTH	CODE	LIST PRICE EA.
24"	CPU182484VS4PKG	\$ 557.75
30"	CPU183084VS4PKG	625.05
36"	CPU183684VS4PKG	663.30
42"	CPU184284VS4PKG	739.50
48"	CPU184884VS4PKG	766.25
54"	CPU185484VS4PKG	842.10
60"	CPU186084VS4PKG	894.40
72"	CPU187284VS4PKG	995.15

LENGTH	CODE	LIST PRICE EA.
22¼"	CPA182484VS4PKG	\$ 421.70
28¾"	CPA183084VS4PKG	489.00
34¼"	CPA183684VS4PKG	527.25
40¼"	CPA184284VS4PKG	603.45
46¼"	CPA184884VS4PKG	630.20
52¼"	CPA185484VS4PKG	706.05
58¼"	CPA186084VS4PKG	758.35
70¼"	CPA187284VS4PKG	859.10

Starter

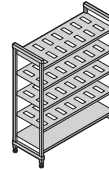

Add-On

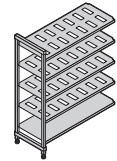

LENGTH	CODE	LIST PRICE EA.
24"	CPU182484VS5PKG	\$ 628.30
30"	CPU183084VS5PKG	712.35
36"	CPU183684VS5PKG	759.95
42"	CPU184284VS5PKG	854.90
48"	CPU184884VS5PKG	888.40
54"	CPU185484VS5PKG	982.85
60"	CPU186084VS5PKG	1,047.90
72"	CPU187284VS5PKG	1,173.60

LENGTH	CODE	LIST PRICE EA.
22¼"	CPA182484VS5PKG	\$ 492.25
28¾"	CPA183084VS5PKG	576.30
34¼"	CPA183684VS5PKG	623.90
40¼"	CPA184284VS5PKG	718.85
46¼"	CPA184884VS5PKG	752.35
52¼"	CPA185484VS5PKG	846.80
58¼"	CPA186084VS5PKG	911.85
70¼"	CPA187284VS5PKG	1,037.55

21"
DEPTH

24"	CPU212484VS4PKG	\$ 597.15
30"	CPU213084VS4PKG	674.70
36"	CPU213684VS4PKG	720.40
42"	CPU214284VS4PKG	806.05
48"	CPU214884VS4PKG	840.55
54"	CPU215484VS4PKG	925.70
60"	CPU216084VS4PKG	984.35
72"	CPU217284VS4PKG	1,102.80

22¼"	CPA212484VS4PKG	\$ 458.30
28¾"	CPA213084VS4PKG	535.85
34¼"	CPA213684VS4PKG	581.55
40¼"	CPA214284VS4PKG	667.20
46¼"	CPA214884VS4PKG	701.70
52¼"	CPA215484VS4PKG	786.85
58¼"	CPA216084VS4PKG	845.50
70¼"	CPA217284VS4PKG	963.95

24"	CPU212484VS5PKG	\$ 676.20
30"	CPU213084VS5PKG	772.70
36"	CPU213684VS5PKG	829.60
42"	CPU214284VS5PKG	936.55
48"	CPU214884VS5PKG	979.10
54"	CPU215484VS5PKG	1,085.45
60"	CPU216084VS5PKG	1,158.65
72"	CPU217284VS5PKG	1,306.05

22¼"	CPA212484VS5PKG	\$ 537.35
28¾"	CPA213084VS5PKG	633.85
34¼"	CPA213684VS5PKG	690.75
40¼"	CPA214284VS5PKG	797.70
46¼"	CPA214884VS5PKG	840.25
52¼"	CPA215484VS5PKG	946.60
58¼"	CPA216084VS5PKG	1,019.80
70¼"	CPA217284VS5PKG	1,167.20

24"
DEPTH

24"	CPU242484VS4PKG	\$ 610.20
30"	CPU243084VS4PKG	690.20
36"	CPU243684VS4PKG	741.30
42"	CPU244284VS4PKG	817.15
48"	CPU244884VS4PKG	868.30
54"	CPU245484VS4PKG	940.75
60"	CPU246084VS4PKG	994.55
72"	CPU247284VS4PKG	1,120.55

22¼"	CPA242484VS4PKG	\$ 470.25
28¾"	CPA243084VS4PKG	550.25
34¼"	CPA243684VS4PKG	601.35
40¼"	CPA244284VS4PKG	677.20
46¼"	CPA244884VS4PKG	728.35
52¼"	CPA245484VS4PKG	800.80
58¼"	CPA246084VS4PKG	854.60
70¼"	CPA247284VS4PKG	980.60

24"	CPU242484VS5PKG	\$ 691.10
30"	CPU243084VS5PKG	790.90
36"	CPU243684VS5PKG	854.60
42"	CPU244284VS5PKG	949.35
48"	CPU244884VS5PKG	1,013.05
54"	CPU245484VS5PKG	1,103.20
60"	CPU246084VS5PKG	1,170.05
72"	CPU247284VS5PKG	1,327.25

22¼"	CPA242484VS5PKG	\$ 551.15
28¾"	CPA243084VS5PKG	650.95
34¼"	CPA243684VS5PKG	714.65
40¼"	CPA244284VS5PKG	809.40
46¼"	CPA244884VS5PKG	873.10
52¼"	CPA245484VS5PKG	963.25
58¼"	CPA246084VS5PKG	1,030.10
70¼"	CPA247284VS5PKG	1,187.30

Color: Speckled Gray (480).

V4

4-Shelf Vented Mobile Starter Units

V5

5-Shelf Vented Mobile Starter Units

Units ship complete in 1 box and include 1 or 2 factory assembled post kits, traverses, shelf plates and 4 swivel, total locking casters.

67"

HEIGHT includes 5" casters.

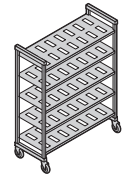
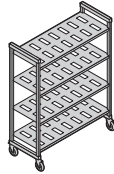

18"

DEPTH

CODE	DIMENSIONS D x L x H	LIST PRICE EA.
CPMU183667V4	18" x 36" x 67"	\$ 914.90
CPMU184267V4	18" x 42" x 67"	989.90
CPMU184867V4	18" x 48" x 67"	1,016.90

21"

DEPTH

CPMU213667V4	21" x 36" x 67"	\$ 970.80
CPMU214267V4	21" x 42" x 67"	1,056.00
CPMU214867V4	21" x 48" x 67"	1,088.20

24"

DEPTH

CPMU243667V4	24" x 36" x 67"	\$ 988.90
CPMU244267V4	24" x 42" x 67"	1,064.50
CPMU244867V4	24" x 48" x 67"	1,114.70

75"

HEIGHT includes 5" casters.

18"

DEPTH

CODE	DIMENSIONS D x L x H	LIST PRICE EA.
CPMU183675V4	18" x 36" x 75"	\$ 919.90
CPMU184275V4	18" x 42" x 75"	994.90
CPMU184875V4	18" x 48" x 75"	1,021.90

21"

DEPTH

CPMU213675V4	21" x 36" x 75"	\$ 975.90
CPMU214275V4	21" x 42" x 75"	1,061.10
CPMU214875V4	21" x 48" x 75"	1,093.30

24"

DEPTH

CPMU243675V4	24" x 36" x 75"	\$ 994.30
CPMU244275V4	24" x 42" x 75"	1,069.90
CPMU244875V4	24" x 48" x 75"	1,120.10

18"

DEPTH

CODE	DIMENSIONS D x L x H	LIST PRICE EA.
CPMU183667V5	18" x 36" x 67"	\$ 1,011.55
CPMU184267V5	18" x 42" x 67"	1,105.30
CPMU184867V5	18" x 48" x 67"	1,139.05

21"

DEPTH

CPMU213667V5	21" x 36" x 67"	\$ 1,080.00
CPMU214267V5	21" x 42" x 67"	1,186.50
CPMU214867V5	21" x 48" x 67"	1,226.75

24"

DEPTH

CPMU243667V5	24" x 36" x 67"	\$ 1,102.20
CPMU244267V5	24" x 42" x 67"	1,196.70
CPMU244867V5	24" x 48" x 67"	1,259.45

18"

DEPTH

CODE	DIMENSIONS D x L x H	LIST PRICE EA.
CPMU183675V5	18" x 36" x 75"	\$ 1,016.55
CPMU184275V5	18" x 42" x 75"	1,110.30
CPMU184875V5	18" x 48" x 75"	1,144.05

21"

DEPTH

CPMU213675V5	21" x 36" x 75"	\$ 1,085.10
CPMU214275V5	21" x 42" x 75"	1,191.60
CPMU214875V5	21" x 48" x 75"	1,231.85

24"

DEPTH

CPMU243675V5	24" x 36" x 75"	\$ 1,107.60
CPMU244275V5	24" x 42" x 75"	1,202.10
CPMU244875V5	24" x 48" x 75"	1,264.85

HIGH DENSITY STORAGE FLOOR TRACK SYSTEM

Maximize storage capacity by creating storage aisles in all available space. This simple system is composed of stationary starter units anchored to a raised floor track system at both ends with high density mobile units installed in between. Easy to install track requires no drilling or gluing.



Increases Storage Capacity Up To

50%

High Density Mobile Units ship complete in 1 box and include factory assembled post kits, vented or solid shelves and high density casters and donut bumpers. Full track and extension kits ship complete with required hardware.

Stationary Starter Units are required to anchor the system at both ends (see Premium Series Stationary Starter Unit spec pages). The Ultimate #10 Can Rack Unit may also be installed on either end, offering high capacity can storage in a compact space.



Active aisle of 30"–36" provides easy access to all stored product.

Stationary Unit*

High Density Mobile Units

Stationary Unit

Raised Floor Track provides a smooth and level surface to easily roll mobile units. Raised track ensures dirt will not get trapped and is easy to clean. Aluminum track and stainless steel hardware are rust resistant.

*It is recommended to use a stationary unit for every 15' of track to further stabilize the system.



Grooved casters roll easily and securely on raised track.

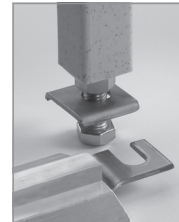

Raised track connects easily to the bottom of a stationary unit that works as a system anchor. No bolts, no glue or drilling into the floor are required. Easy and fast set up.

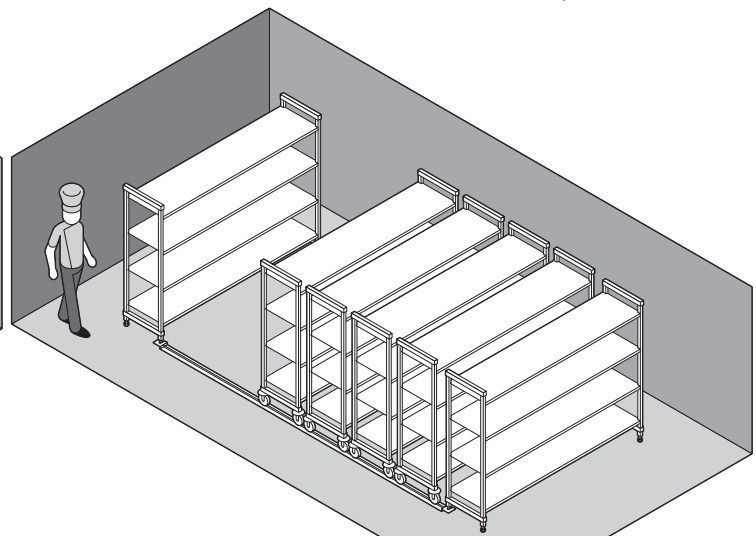
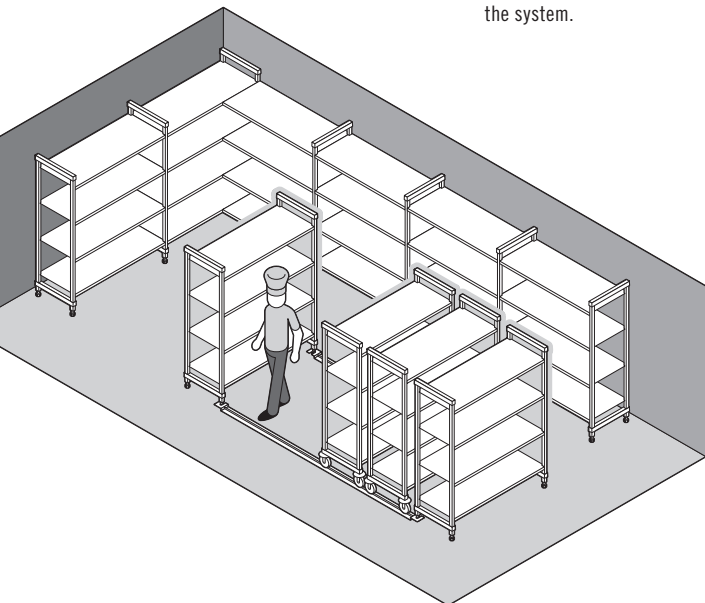

High Density Full Track and Track Extension Kits

Each kit ships complete in 1 box with aluminum raised track rails and stainless steel hardware required to complete installation.

CODE	DESCRIPTION	CASE PACK	LIST PRICE EA.
Full Track Kits			
CSMHDTK10	10' Track for 3 Mobile Units*	1	\$ 638.60
CSMHDTK12	12' Track for 4 Mobile Units*	1	736.45
CSMHDTK145	14.5' Track for 5 Mobile Units*	1	829.15

Color: Silver (000). *Based on 24" deep mobile units.

Full Track Kits include: Track rails, rail joiners, end plates, 8 stainless steel leveling feet (for stationary units) and required hardware.

CODE	DESCRIPTION	CASE PACK	LIST PRICE EA.
Track Extension Kits			
CSMHDTKE4	4.5' Track Extension	1	\$ 240.90
CSMHDTKE5	5' Track Extension	1	257.25
CSMHDTKE6	6' Track Extension	1	305.40

Color: Silver (000). **Extension Track Kits include:** Track rails (1 set), 2 rail joiners, and required hardware.



Track rail (underside) shown with end plate installed.



Track rail (underside) shown with track rail joiner partially installed.

It is highly recommended to install a stationary starter unit every 15' of track to further stabilize the system.

High Density Floor Fastener

Secure stationary unit front posts with rails directly to the floor for added safety and stability where required. Made of stainless steel. Bolts not included.



Hole diameter 9/16".

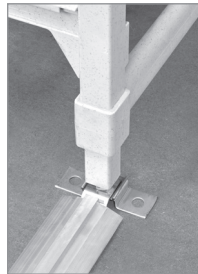

CODE	DIMENSION D x L x H	LIST PRICE EA.
------	------------------------	-------------------

Premium Series High Density

CSHDF 1 3/8" x 4 1/4" x 1/2" \$ 41.35

Case Pack: 4 Color: Silver (000).

High Density Caster With Donut Bumper



CODE	SIZE	LIST PRICE EA.
CPMCHD	5"	\$ 55.55

Case Pack: 2 Color: Gray (000).



V4

4-Shelf Vented High Density Mobile Units

S4

4-Shelf Solid High Density Mobile Units

Units ship complete in 1 box and include 1 or 2 factory assembled post kits, traverses, shelf plates, 4 high density casters and 4 donut bumpers.

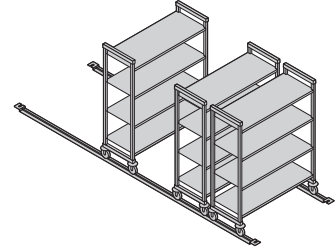
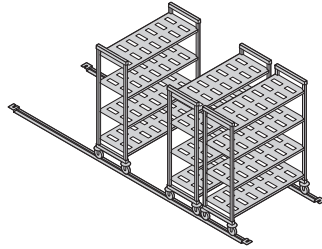

67"

HEIGHT includes 5" casters.

21"

DEPTH

CODE	DIMENSIONS D x L x H	LIST PRICE EA.
CPHU213667V4	21" x 36" x 67"	\$ 992.50
CPHU214267V4	21" x 42" x 67"	1,077.70
CPHU214867V4	21" x 48" x 67"	1,109.90
CPHU215467V4	21" x 54" x 67"	1,194.70
CPHU216067V4	21" x 60" x 67"	1,252.90

24"

DEPTH

CPHU243667V4	24" x 36" x 67"	\$ 1,010.70
CPHU244267V4	24" x 42" x 67"	1,086.30
CPHU244867V4	24" x 48" x 67"	1,136.50
CPHU245467V4	24" x 54" x 67"	1,207.30
CPHU246067V4	24" x 60" x 67"	1,259.50

75"

HEIGHT includes 5" casters.

21"

DEPTH

CODE	DIMENSIONS D x L x H	LIST PRICE EA.
CPHU213675V4	21" x 36" x 75"	\$ 997.70
CPHU214275V4	21" x 42" x 75"	1,082.90
CPHU214875V4	21" x 48" x 75"	1,115.10
CPHU215475V4	21" x 54" x 75"	1,199.90
CPHU216075V4	21" x 60" x 75"	1,258.10

24"

DEPTH

CPHU243675V4	24" x 36" x 75"	\$ 1,016.00
CPHU244275V4	24" x 42" x 75"	1,091.60
CPHU244875V4	24" x 48" x 75"	1,141.80
CPHU245475V4	24" x 54" x 75"	1,212.60
CPHU246075V4	24" x 60" x 75"	1,264.80

21"

DEPTH

CODE	DIMENSIONS D x L x H	LIST PRICE EA.
CPHU213667S4	21" x 36" x 67"	\$ 1,016.10
CPHU214267S4	21" x 42" x 67"	1,103.10
CPHU214867S4	21" x 48" x 67"	1,144.50
CPHU215467S4	21" x 54" x 67"	1,230.70
CPHU216067S4	21" x 60" x 67"	1,290.70

24"

DEPTH

CPHU243667S4	24" x 36" x 67"	\$ 1,043.50
CPHU244267S4	24" x 42" x 67"	1,120.10
CPHU244867S4	24" x 48" x 67"	1,174.10
CPHU245467S4	24" x 54" x 67"	1,251.50
CPHU246067S4	24" x 60" x 67"	1,310.10

21"

DEPTH

CODE	DIMENSIONS D x L x H	LIST PRICE EA.
CPHU213675S4	21" x 36" x 75"	\$ 1,021.30
CPHU214275S4	21" x 42" x 75"	1,108.30
CPHU214875S4	21" x 48" x 75"	1,149.70
CPHU215475S4	21" x 54" x 75"	1,235.90
CPHU216075S4	21" x 60" x 75"	1,295.90

24"

DEPTH

CPHU243675S4	24" x 36" x 75"	\$ 1,048.80
CPHU244275S4	24" x 42" x 75"	1,125.40
CPHU244875S4	24" x 48" x 75"	1,179.40
CPHU245475S4	24" x 54" x 75"	1,256.80
CPHU246075S4	24" x 60" x 75"	1,315.40



High Density Mobile Post Kits

Ships **unassembled** in 1 box. Includes 2 mobile posts, post connectors, 2 high density casters and donut bumpers. Mobile and stationary posts are not interchangeable.

67"

HEIGHT includes 5" casters.

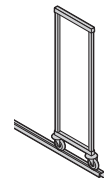

18"
DEPTH

CODE	DIMENSIONS D x H	LIST PRICE EA.
CPMPKHD1867	18" x 67"	\$ 253.00

21"
DEPTH

CPMPKHD2167	21" x 67"	\$ 255.85
-------------	-----------	-----------

24"
DEPTH

CPMPKHD2467	24" x 67"	\$ 256.75
-------------	-----------	-----------

75"

HEIGHT includes 5" casters.

18"
DEPTH

CODE	DIMENSIONS D x H	LIST PRICE EA.
CPMPKHD1875	18" x 75"	\$ 255.55

21"
DEPTH

CPMPKHD2175	21" x 75"	\$ 258.45
-------------	-----------	-----------

24"
DEPTH

CPMPKHD2475	24" x 75"	\$ 259.40
-------------	-----------	-----------



Color: Speckled Gray (480).

Stationary Post Kits

Ships **unassembled** in 1 box.
Includes 2 stationary posts and post connectors.
Mobile and stationary posts are not interchangeable.

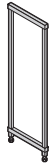

32"
HEIGHT

CODE	DIMENSIONS D x H	LIST PRICE EA.
CPPK1432	14" x 32"	\$ 73.80
CPPK1832	18" x 32"	79.00
CPPK2132	21" x 32"	82.00
CPPK2432	24" x 32"	82.85

56"
HEIGHT

CPPK1456	14" x 56"	\$ 100.85
CPPK1856	18" x 56"	106.05
CPPK2156	21" x 56"	109.10
CPPK2456	24" x 56"	109.90

64"
HEIGHT

CPPK1464	14" x 64"	\$ 110.00
CPPK1864	18" x 64"	115.20
CPPK2164	21" x 64"	118.20
CPPK2464	24" x 64"	119.00

72"
HEIGHT

CPPK1472	14" x 72"	\$ 112.65
CPPK1872	18" x 72"	117.75
CPPK2172	21" x 72"	120.55
CPPK2472	24" x 72"	121.70

84"
HEIGHT

CPPK1484	14" x 84"	\$ 130.80
CPPK1884	18" x 84"	136.05
CPPK2184	21" x 84"	138.85
CPPK2484	24" x 84"	139.95

Color: Speckled Gray (480).

Standard Mobile Post Kits

Ships **unassembled** in 1 box. Includes 2 mobile posts,
post connectors and 2 swivel, total locking casters.
Mobile and stationary posts are not interchangeable.



35"
HEIGHT
includes
5" casters.

CODE	DIMENSIONS D x H	LIST PRICE EA.
CPMPK1835	18" x 35"	\$ 226.00
CPMPK2135	21" x 35"	228.85
CPMPK2435	24" x 35"	229.85

59"
HEIGHT
includes
5" casters.

CPMPK1859	18" x 59"	\$ 254.50
CPMPK2159	21" x 59"	257.45
CPMPK2459	24" x 59"	258.40

67"
HEIGHT
includes
5" casters.

CPMPK1867	18" x 67"	\$ 264.15
CPMPK2167	21" x 67"	267.00
CPMPK2467	24" x 67"	267.85

75"
HEIGHT
includes
5" casters.

CPMPK1875	18" x 75"	\$ 266.65
CPMPK2175	21" x 75"	269.55
CPMPK2475	24" x 75"	270.55

Color: Speckled Gray (480).

Standard Mobile Donut Bumper

Offers added protection during transport and when maneuvering mobile units into place against walls or alongside other units for storage. Cannot be used on High Density Mobile Units.



CODE	DIAMETER	LIST PRICE EA.
CPMDB	3½"	\$ 9.60

Case Pack: 4 Color: Gray (000).

V1

Single Vented Shelf Kits

S1

Single Solid Shelf Kits

Includes 2 shelf traverses and vented or solid shelf plates.
Fits mobile or stationary units. Ships in 1 box.

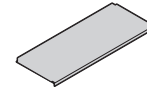
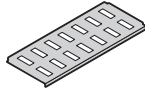

14"
DEPTH

CODE	DIMENSIONS D x L	LIST PRICE EA.
CPSK1424V1	14" x 24"	\$ 68.80
CPSK1430V1	14" x 30"	85.50
CPSK1436V1	14" x 36"	94.75
CPSK1442V1	14" x 42"	108.45
CPSK1448V1	14" x 48"	120.15
CPSK1454V1	14" x 54"	133.75
CPSK1460V1	14" x 60"	143.50
CPSK1472V1	14" x 72"	168.50

14"
DEPTH

CODE	DIMENSIONS D x L	LIST PRICE EA.
CPSK1424S1	14" x 24"	\$ 70.50
CPSK1430S1	14" x 30"	87.55
CPSK1436S1	14" x 36"	97.30
CPSK1442S1	14" x 42"	112.05
CPSK1448S1	14" x 48"	123.50
CPSK1454S1	14" x 54"	138.15
CPSK1460S1	14" x 60"	149.05
CPSK1472S1	14" x 72"	174.85

18"
DEPTH

CPSK1824V1	18" x 24"	\$ 70.55
CPSK1830V1	18" x 30"	87.30
CPSK1836V1	18" x 36"	96.65
CPSK1842V1	18" x 42"	115.40
CPSK1848V1	18" x 48"	122.15
CPSK1854V1	18" x 54"	140.75
CPSK1860V1	18" x 60"	153.50
CPSK1872V1	18" x 72"	178.45

18"
DEPTH

CPSK1824S1	18" x 24"	\$ 74.00
CPSK1830S1	18" x 30"	91.05
CPSK1836S1	18" x 36"	101.25
CPSK1842S1	18" x 42"	121.20
CPSK1848S1	18" x 48"	127.70
CPSK1854S1	18" x 54"	147.75
CPSK1860S1	18" x 60"	161.80
CPSK1872S1	18" x 72"	187.70

21"
DEPTH

CPSK2124V1	21" x 24"	\$ 79.05
CPSK2130V1	21" x 30"	98.00
CPSK2136V1	21" x 36"	109.20
CPSK2142V1	21" x 42"	130.50
CPSK2148V1	21" x 48"	138.55
CPSK2154V1	21" x 54"	159.75
CPSK2160V1	21" x 60"	174.30
CPSK2172V1	21" x 72"	203.25

21"
DEPTH

CPSK2124S1	21" x 24"	\$ 82.30
CPSK2130S1	21" x 30"	103.00
CPSK2136S1	21" x 36"	115.10
CPSK2142S1	21" x 42"	136.85
CPSK2148S1	21" x 48"	147.20
CPSK2154S1	21" x 54"	168.75
CPSK2160S1	21" x 60"	183.75
CPSK2172S1	21" x 72"	215.35

24"
DEPTH

CPSK2424V1	24" x 24"	\$ 80.90
CPSK2430V1	24" x 30"	100.70
CPSK2436V1	24" x 36"	113.30
CPSK2442V1	24" x 42"	132.20
CPSK2448V1	24" x 48"	144.75
CPSK2454V1	24" x 54"	162.45
CPSK2460V1	24" x 60"	175.50
CPSK2472V1	24" x 72"	206.70

24"
DEPTH

CPSK2424S1	24" x 24"	\$ 87.60
CPSK2430S1	24" x 30"	108.20
CPSK2436S1	24" x 36"	121.50
CPSK2442S1	24" x 42"	140.65
CPSK2448S1	24" x 48"	154.15
CPSK2454S1	24" x 54"	173.50
CPSK2460S1	24" x 60"	188.15
CPSK2472S1	24" x 72"	220.55

V4 4-Shelf Vented Kits

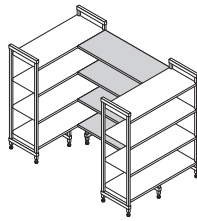

Includes 8 shelf traverses and vented or solid shelf plates. Fits mobile or stationary units.
Ships in 1 box. Install with 8 sets of corner connectors (CPC8) to create a U-shape unit.

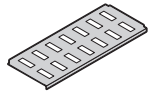

18"
DEPTH

CODE	DIMENSIONS D x L	LIST PRICE EA.
CPSK1836V4	18" x 36"	\$ 386.60
CPSK1842V4	18" x 42"	461.60
CPSK1848V4	18" x 48"	488.60

21"
DEPTH

CPSK2136V4	21" x 36"	\$ 436.80
CPSK2142V4	21" x 42"	522.00
CPSK2148V4	21" x 48"	554.20

24"
DEPTH

CPSK2436V4	24" x 36"	\$ 453.20
CPSK2442V4	24" x 42"	528.80
CPSK2448V4	24" x 48"	579.00

S4 4-Shelf Solid Kits

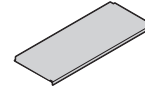

18"
DEPTH

CODE	DIMENSIONS D x L	LIST PRICE EA.
CPSK1836S4	18" x 36"	\$ 405.00
CPSK1842S4	18" x 42"	484.80
CPSK1848S4	18" x 48"	510.80

21"
DEPTH

CPSK2136S4	21" x 36"	\$ 460.40
CPSK2142S4	21" x 42"	547.40
CPSK2148S4	21" x 48"	588.80

24"
DEPTH

CPSK2436S4	24" x 36"	\$ 486.00
CPSK2442S4	24" x 42"	562.60
CPSK2448S4	24" x 48"	616.60

V5 5-Shelf Vented Kits

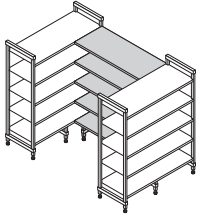

Includes 10 shelf traverses and vented or solid shelf plates. Fits mobile or stationary units.
Ships in 1 box. Install with 10 sets of corner connectors (CPC10) to create a U-shape unit.

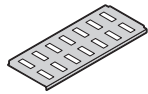

18"
DEPTH

CODE	DIMENSIONS D x L	LIST PRICE EA.
CPSK1836V5	18" x 36"	\$ 483.25
CPSK1842V5	18" x 42"	577.00
CPSK1848V5	18" x 48"	610.75

21"
DEPTH

CPSK2136V5	21" x 36"	\$ 546.00
CPSK2142V5	21" x 42"	652.50
CPSK2148V5	21" x 48"	692.75

24"
DEPTH

CPSK2436V5	24" x 36"	\$ 566.50
CPSK2442V5	24" x 42"	661.00
CPSK2448V5	24" x 48"	723.75

S5 5-Shelf Solid Kits

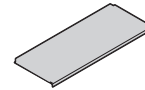

18"
DEPTH

CODE	DIMENSIONS D x L	LIST PRICE EA.
CPSK1836S5	18" x 36"	\$ 506.25
CPSK1842S5	18" x 42"	606.00
CPSK1848S5	18" x 48"	638.50

21"
DEPTH

CPSK2136S5	21" x 36"	\$ 575.50
CPSK2142S5	21" x 42"	684.25
CPSK2148S5	21" x 48"	736.00

24"
DEPTH

CPSK2436S5	24" x 36"	\$ 607.50
CPSK2442S5	24" x 42"	703.25
CPSK2448S5	24" x 48"	770.75



VS4 4-Shelf Kits

(3 Vented + 1 Solid)

Includes 8 shelf traverses and vented or solid shelf plates.
Fits mobile or stationary units. Ships in one carton. Install with
8 sets of corner connectors (CPCC8) to create a U-shape unit.

18"
DEPTH

CODE	DIMENSIONS D x L	LIST PRICE EA.
CPSK1836VS4	18" x 36"	\$ 391.20
CPSK1842VS4	18" x 42"	467.40
CPSK1848VS4	18" x 48"	494.15

21"
DEPTH

CPSK2136VS4	21" x 36"	\$ 442.70
CPSK2142VS4	21" x 42"	528.35
CPSK2148VS4	21" x 48"	562.85

24"
DEPTH

CPSK2436VS4	24" x 36"	\$ 461.40
CPSK2442VS4	24" x 42"	537.25
CPSK2448VS4	24" x 48"	588.40



VS5 5-Shelf Kits

(4 Vented + 1 Solid)

Includes 10 shelf traverses and vented or solid shelf plates.
Fits mobile or stationary units. Ships in one carton. Install with
10 sets of corner connectors (CPCC10) to create a U-shape unit.

18"
DEPTH

CODE	DIMENSIONS D x L	LIST PRICE EA.
CPSK1836VS5	18" x 36"	\$ 487.85
CPSK1842VS5	18" x 42"	582.80
CPSK1848VS5	18" x 48"	616.30

21"
DEPTH

CPSK2136VS5	21" x 36"	\$ 551.90
CPSK2142VS5	21" x 42"	658.85
CPSK2148VS5	21" x 48"	701.40

24"
DEPTH

CPSK2436VS5	24" x 36"	\$ 574.70
CPSK2442VS5	24" x 42"	669.45
CPSK2448VS5	24" x 48"	733.15

Color: Speckled Gray (480).

Corner Connectors

Unique patented design ensures maximum shelf space utilization. Use 1 set per shelf to connect starter and add-on units in corners. Connect 4 or 5 intermediate shelves between 2 starter units (2 sets required per shelf). Available as a single set or 8 or 10 set packs.

CODE	DESCRIPTION	LIST PRICE EA.
CPCC1	1 Set for 1 shelf	\$ 5.55
CPCC8	8 Sets for 4 shelves	44.40
CPCC10	10 Sets for 5 shelves	55.50

Color: Speckled Gray (480).

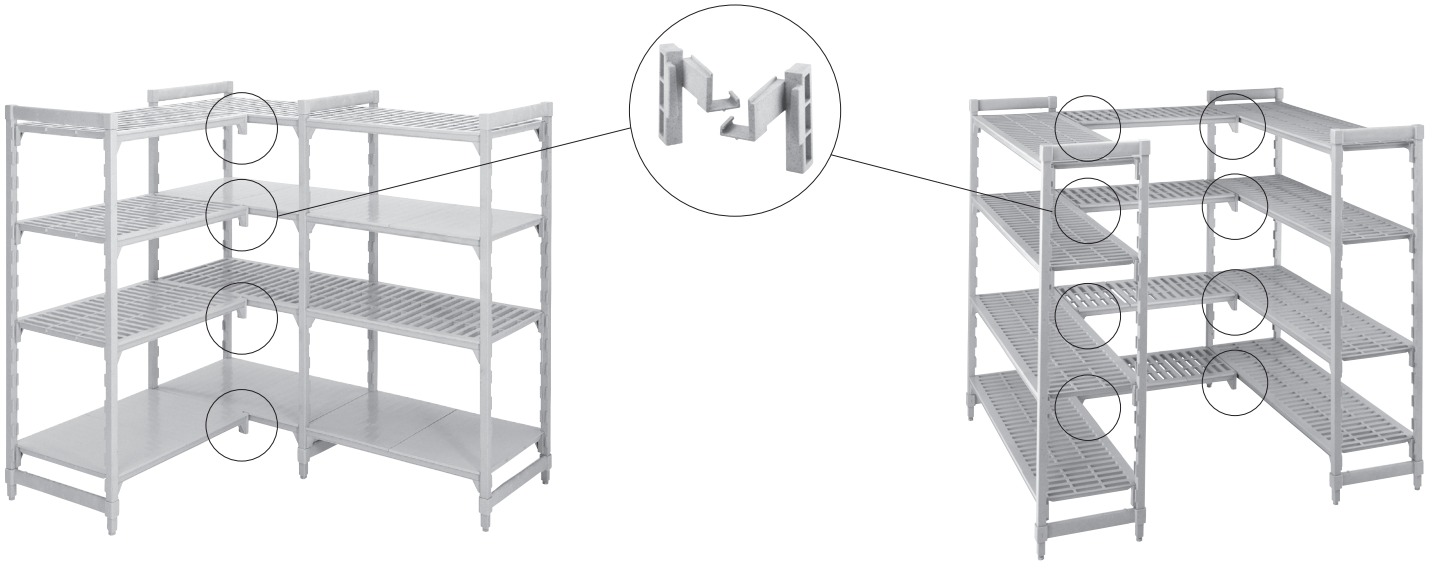

Bottom Shelf Dunnage Stands

Increase weight bearing capacity on bottom shelf only. Add to any shelf length. Highly recommended for starter units 54" and longer and all corner units, intermediate units and units specified for heavier load volume on and off bottom shelves.

CODE	DIMENSIONS D x H	LIST PRICE EA.
Dunnage Stand – Low (bottom shelf installed on lowest post dovetails)		
CPDS14H6	14" x 7½"	\$ 73.25
CPDS18H6	18" x 7½"	75.65
CPDS21H6	21" x 7½"	77.55
CPDS24H6	24" x 7½"	79.50

Dunnage Stand – Tall (bottom shelf installed on 2nd set up of post dovetails)		
CPDS14H11	14" x 11⅜"	79.30
CPDS18H11	18" x 11⅜"	81.75
CPDS21H11	21" x 11⅜"	83.65
CPDS24H11	24" x 11⅜"	85.60

Case Pack: 1 Color: Speckled Gray (480).

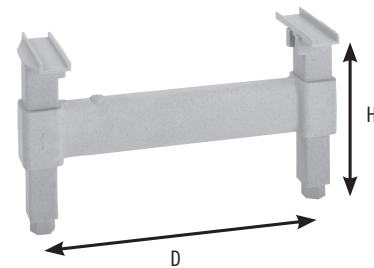

Bottom Shelf with Dunnage Stand

UNIT LENGTH	WEIGHT BEARING
Standard Unit	
24" - 48"	1,200 lbs.
54" - 72"	900
Corner Unit with 2 Dunnage Stands	
24" - 48"	600

Shelf Traverses

Available in single or double packs. Use a single set to add an open shelf for divider bars or drying racks. Add single traverse on the back of the unit for extra support when significant space is required between the bottom and second shelf or when placing rolling equipment under the first shelf.



LENGTH	SINGLE PACK CODE*	LIST PRICE EA.	DOUBLE PACK CODE**	LIST PRICE EA.
24"	CPTR24	\$ 32.30	CPTR242PK	\$ 56.50
30"	CPTR30	34.90	CPTR302PK	61.20
36"	CPTR36	38.00	CPTR362PK	66.50
42"	CPTR42	40.60	CPTR422PK	72.50
48"	CPTR48	44.30	CPTR482PK	79.10
54"	CPTR54	48.10	CPTR542PK	85.80
60"	CPTR60	51.80	CPTR602PK	92.50
72"	CPTR72	56.50	—	—

*Case Pack: 1 **Case Pack: 2 Color: Speckled Gray (480).



CAMSHELVING ELEMENTS® series

STATIONARY | MOBILE | UNDERCOUNTER

WHY CHOOSE ELEMENTS?

Made from a revolutionary, extremely strong composite material with a smooth, easy to clean surface. Elements Series is stronger than common wire shelving. It's lighter in weight than Camshelving Premium Series and totally impervious to moisture, chemicals and liquids that can destroy shelving over time. Elements Series is designed for medium to heavy storage use in freezers, coolers, dry storage or warewashing areas. It easily supports the performance demands of a busy foodservice operation.

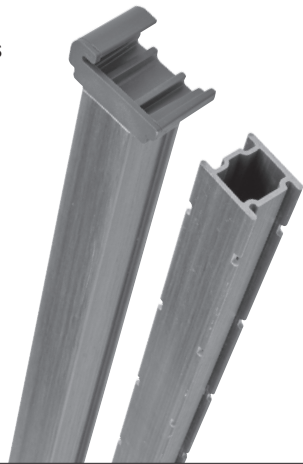

camguard.
ANTIMICROBIAL SHELF PLATES



COMPONENT



Post Connectors, Corner Connectors, Floor Fastener, Wall Fastener, Identification Tags, Single Shelf Security Cage, Ultimate #10 Can Rack, and Shelf Divider Bars are not NSF Listed.

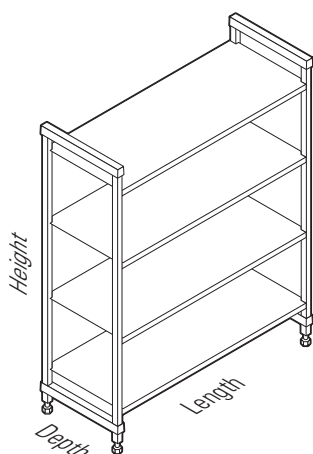

Stationary Unit Sizes

4 Depths		
14"	18"	
21"	24"	
8 Lengths		
24"	30"	36"
42"	48"	54"
60"	72"	
3 Heights		
64"	72"	84"

Mobile Unit Sizes

3 Depths		
18"	21"	24"
5 Lengths		
36"	42"	48"
54"	60"	
2 Heights		
70"	78"	

Undercounter Unit Sizes

2 Depths	
14"	18"
3 Lengths	
24"	36" 48"
2 Heights	
27" mobile	30" stationary

Weight Bearing Capacity

Weight must be evenly distributed across the entire shelf.

		UNIT LENGTH 24" – 48"	UNIT LENGTH 54" – 72"
SINGLE UNIT	Unit only	2,000 lbs.	2,000 lbs.
	Shelf only	800	600
	Unit with dunnage stand*	2,400	2,300
	Bottom shelf with dunnage stand*	1,200	900
CORNER UNIT*** With 2 Dunnage Stands required	Unit only	1,800	—
	Shelf only	400	—
	Bottom shelf with dunnage stands*	600	—
MOBILE UNIT	Unit only**	750	—

*Dunnage Stands add stability and increase weight bearing capacity on bottom shelf only. Add to any shelf length. Highly recommended for Starter Units 54" and longer, all Corner Units, U-Shape Units and units specified for heavier loads (See page 04).

**Due to the weight bearing capacity of casters, maximum weight load on an entire Mobile Unit is 750 lbs.

***Corner connectors are for use only with shelves 24" - 48" long.



CAMSHELVING ELEMENTS® SERIES – STARTER, ADD-ON AND MOBILE UNITS

V4 4-Shelf or 5-Shelf Vented
V5 Stationary Starter
 and Add-On Units

HEIGHTS	DEPTHS	LENGTHS	
3	3	8	
64"	18"	24"	48"
72"	21"	30"	54"
84"	24"	36"	60"
		42"	72"

V2 2-Shelf Undercounter Vented
 Stationary Starter Units

HEIGHT	DEPTH	LENGTHS
1	1	2
30"	18"	36"
		48"

S4 4-Shelf Solid Stationary
 Starter and Add-On Units

HEIGHTS	DEPTHS	LENGTHS	
3	3	8	
64"	18"	24"	48"
72"	21"	30"	54"
84"	24"	36"	60"
		42"	72"

S5 5-Shelf Solid Stationary
 Starter and Add-On Units

HEIGHT	DEPTHS	LENGTHS	
1	3	8	
84"	18"	24"	48"
	21"	30"	54"
	24"	36"	60"
		42"	72"

VS4 4-Shelf Vented and Solid
 Stationary Starter and
 Add-On Units (3 vented + 1 solid)

HEIGHTS	DEPTHS	LENGTHS	
3	3	8	
64"	18"	24"	48"
72"	21"	30"	54"
84"	24"	36"	60"
		42"	72"

VS5 5-Shelf Vented and Solid
 Stationary Starter and
 Add-On Units (4 vented + 1 solid)

HEIGHT	DEPTHS	LENGTHS	
1	3	8	
84"	18"	24"	48"
	21"	30"	54"
	24"	36"	60"
		42"	72"

V4 4-Shelf or 5-Shelf Vented
V5 Mobile Starter Units

HEIGHTS*	DEPTHS	LENGTHS	
2	3	5	
70"	18"	36"	54"
78"	21"	42"	60"
	24"	48"	

*Includes 5" casters.

V2 2-Shelf Undercounter Vented
 Mobile Starter Units

HEIGHT*	DEPTH	LENGTHS
1	1	3
27"	14"	24"
		36"
		48"

*Includes 5" casters.

V4

4-Shelf Vented Stationary
Starter and Add-On Units

V5

5-Shelf Vented Stationary
Starter and Add-On Units

Units ship complete in 1 box and include 1 or 2 factory assembled post kits,
traverses, dovetails and shelf plates.

64"

HEIGHT

Starter

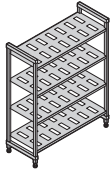

Add-On

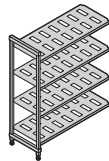

18"

DEPTH

LENGTH	CODE	LIST PRICE EA.
24"	ESU182464V4	\$ 416.90
30"	ESU183064V4	429.90
36"	ESU183664V4	472.70
42"	ESU184264V4	530.70
48"	ESU184864V4	551.50
54"	ESU185464V4	609.10
60"	ESU186064V4	648.70
72"	ESU187264V4	725.90

LENGTH	CODE	LIST PRICE EA.
22"	EA182464V4	\$ 330.25
28"	EA183064V4	343.25
34"	EA183664V4	386.05
40"	EA184264V4	444.05
46"	EA184864V4	464.85
52"	EA185464V4	522.45
58"	EA186064V4	562.05
70"	EA187264V4	639.25

Starter

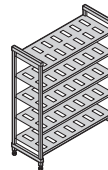

Add-On

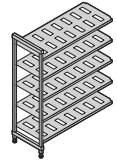

LENGTH	CODE	LIST PRICE EA.
24"	ESU182464V5	\$ 477.80
30"	ESU183064V5	494.05
36"	ESU183664V5	547.55
42"	ESU184264V5	620.05
48"	ESU184864V5	646.05
54"	ESU185464V5	718.05
60"	ESU186064V5	767.55
72"	ESU187264V5	864.05

LENGTH	CODE	LIST PRICE EA.
22"	EA182464V5	\$ 391.15
28"	EA183064V5	407.40
34"	EA183664V5	460.90
40"	EA184264V5	533.40
46"	EA184864V5	559.40
52"	EA185464V5	631.40
58"	EA186064V5	680.90
70"	EA187264V5	777.40

21"

DEPTH

24"	ESU212464V4	\$ 450.20
30"	ESU213064V4	466.60
36"	ESU213664V4	516.00
42"	ESU214264V4	581.60
48"	ESU214864V4	606.60
54"	ESU215464V4	672.40
60"	ESU216064V4	717.60
72"	ESU217264V4	807.40

22"	EA212464V4	\$ 361.30
28"	EA213064V4	377.70
34"	EA213664V4	427.10
40"	EA214264V4	492.70
46"	EA214864V4	517.70
52"	EA215464V4	583.50
58"	EA216064V4	628.70
70"	EA217264V4	718.50

24"	ESU212464V5	\$ 518.30
30"	ESU213064V5	538.80
36"	ESU213664V5	600.55
42"	ESU214264V5	682.55
48"	ESU214864V5	713.80
54"	ESU215464V5	796.05
60"	ESU216064V5	852.55
72"	ESU217264V5	964.80

22"	EA212464V5	\$ 429.40
28"	EA213064V5	449.90
34"	EA213664V5	511.65
40"	EA214264V5	593.65
46"	EA214864V5	624.90
52"	EA215464V5	707.15
58"	EA216064V5	763.65
70"	EA217264V5	875.90

24"

DEPTH

24"	ESU242464V4	\$ 461.40
30"	ESU243064V4	487.00
36"	ESU243664V4	530.00
42"	ESU244264V4	588.80
48"	ESU244864V4	627.20
54"	ESU245464V4	682.00
60"	ESU246064V4	722.80
72"	ESU247264V4	819.20

22"	EA242464V4	\$ 371.80
28"	EA243064V4	397.40
34"	EA243664V4	440.40
40"	EA244264V4	499.20
46"	EA244864V4	537.60
52"	EA245464V4	592.40
58"	EA246064V4	633.20
70"	EA247264V4	729.60

24"	ESU242464V5	\$ 531.95
30"	ESU243064V5	563.95
36"	ESU243664V5	617.70
42"	ESU244264V5	691.20
48"	ESU244864V5	739.20
54"	ESU245464V5	807.70
60"	ESU246064V5	858.70
72"	ESU247264V5	979.20

22"	EA242464V5	\$ 442.35
28"	EA243064V5	474.35
34"	EA243664V5	528.10
40"	EA244264V5	601.60
46"	EA244864V5	649.60
52"	EA245464V5	718.10
58"	EA246064V5	769.10
70"	EA247264V5	889.60

Color: Brushed Graphite (580).

S4

4-Shelf Solid Stationary Starter and Add-On Units

VS4

4-Shelf Vented and Solid Stationary Starter and Add-On Units

(3 Vented + 1 Solid)

Units ship complete in 1 box and include 1 or 2 factory assembled post kits, traverses, dovetails and shelf plates.

64"
HEIGHT

Starter

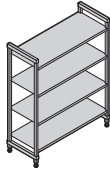

Add-On

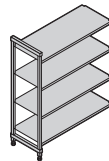

18"
DEPTH

LENGTH	CODE	LIST PRICE EA.
24"	ESU182464S4	\$ 439.90
30"	ESU183064S4	441.30
36"	ESU183664S4	486.70
42"	ESU184264S4	548.70
48"	ESU184864S4	568.50
54"	ESU185464S4	630.90
60"	ESU186064S4	674.30
72"	ESU187264S4	754.50

LENGTH	CODE	LIST PRICE EA.
22"	EA182464S4	\$ 353.25
28"	EA183064S4	354.65
34"	EA183664S4	400.05
40"	EA184264S4	462.05
46"	EA184864S4	481.85
52"	EA185464S4	544.25
58"	EA186064S4	587.65
70"	EA187264S4	667.85

Starter

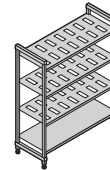

Add-On

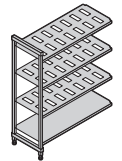

LENGTH	CODE	LIST PRICE EA.
24"	ESU182464VS4	\$ 422.65
30"	ESU183064VS4	432.75
36"	ESU183664VS4	476.20
42"	ESU184264VS4	535.20
48"	ESU184864VS4	555.75
54"	ESU185464VS4	614.55
60"	ESU186064VS4	655.10
72"	ESU187264VS4	733.05

LENGTH	CODE	LIST PRICE EA.
22"	EA182464VS4	\$ 336.00
28"	EA183064VS4	346.10
34"	EA183664VS4	389.55
40"	EA184264VS4	448.55
46"	EA184864VS4	469.10
52"	EA185464VS4	527.90
58"	EA186064VS4	568.45
70"	EA187264VS4	646.40

21"
DEPTH

24"	ESU212464S4	\$ 464.40
30"	ESU213064S4	482.20
36"	ESU213664S4	534.40
42"	ESU214264S4	601.40
48"	ESU214864S4	633.40
54"	ESU215464S4	700.40
60"	ESU216064S4	747.00
72"	ESU217264S4	844.60

22"	EA212464S4	\$ 375.50
28"	EA213064S4	393.30
34"	EA213664S4	445.50
40"	EA214264S4	512.50
46"	EA214864S4	544.50
52"	EA215464S4	611.50
58"	EA216064S4	658.10
70"	EA217264S4	755.70

24"	ESU212464VS4	\$ 453.75
30"	ESU213064VS4	470.50
36"	ESU213664VS4	520.60
42"	ESU214264VS4	586.55
48"	ESU214864VS4	613.30
54"	ESU215464VS4	679.40
60"	ESU216064VS4	724.95
72"	ESU217264VS4	816.70

22"	EA212464VS4	\$ 364.85
28"	EA213064VS4	381.60
34"	EA213664VS4	431.70
40"	EA214264VS4	497.65
46"	EA214864VS4	524.40
52"	EA215464VS4	590.50
58"	EA216064VS4	636.05
70"	EA217264VS4	727.80

24"
DEPTH

24"	ESU242464S4	\$ 473.40
30"	ESU243064S4	504.00
36"	ESU243664S4	555.40
42"	ESU244264S4	614.80
48"	ESU244864S4	656.20
54"	ESU245464S4	716.40
60"	ESU246064S4	761.80
72"	ESU247264S4	862.00

22"	EA242464S4	\$ 383.80
28"	EA243064S4	414.40
34"	EA243664S4	465.80
40"	EA244264S4	525.20
46"	EA244864S4	566.60
52"	EA245464S4	626.80
58"	EA246064S4	672.20
70"	EA247264S4	772.40

24"	ESU242464VS4	\$ 464.40
30"	ESU243064VS4	491.25
36"	ESU243664VS4	536.35
42"	ESU244264VS4	595.30
48"	ESU244864VS4	634.45
54"	ESU245464VS4	690.60
60"	ESU246064VS4	732.55
72"	ESU247264VS4	829.90

22"	EA242464VS4	\$ 374.80
28"	EA243064VS4	401.65
34"	EA243664VS4	446.75
40"	EA244264VS4	505.70
46"	EA244864VS4	544.85
52"	EA245464VS4	601.00
58"	EA246064VS4	642.95
70"	EA247264VS4	740.30

Color: Brushed Graphite (580).

V4

4-Shelf Vented Stationary
Starter and Add-On Units

V5

5-Shelf Vented Stationary
Starter and Add-On Units

Units ship complete in 1 box and include 1 or 2 factory assembled post kits,
traverses, dovetails and shelf plates.

72"
HEIGHT

Starter

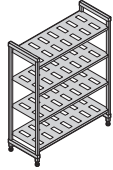

Add-On

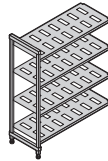

18"
DEPTH

LENGTH	CODE	LIST PRICE EA.
24"	ESU182472V4	\$ 420.90
30"	ESU183072V4	433.90
36"	ESU183672V4	476.70
42"	ESU184272V4	534.70
48"	ESU184872V4	555.50
54"	ESU185472V4	613.10
60"	ESU186072V4	652.70
72"	ESU187272V4	729.90

LENGTH	CODE	LIST PRICE EA.
22"	EA182472V4	\$ 332.25
28"	EA183072V4	345.25
34"	EA183672V4	388.05
40"	EA184272V4	446.05
46"	EA184872V4	466.85
52"	EA185472V4	524.45
58"	EA186072V4	564.05
70"	EA187272V4	641.25

Starter

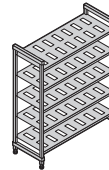

Add-On

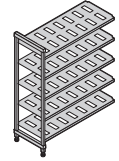

LENGTH	CODE	LIST PRICE EA.
24"	ESU182472V5	\$ 481.80
30"	ESU183072V5	498.05
36"	ESU183672V5	551.55
42"	ESU184272V5	624.05
48"	ESU184872V5	650.05
54"	ESU185472V5	722.05
60"	ESU186072V5	771.55
72"	ESU187272V5	868.05

LENGTH	CODE	LIST PRICE EA.
22"	EA182472V5	\$ 393.15
28"	EA183072V5	409.40
34"	EA183672V5	462.90
40"	EA184272V5	535.40
46"	EA184872V5	561.40
52"	EA185472V5	633.40
58"	EA186072V5	682.90
70"	EA187272V5	779.40

21"
DEPTH

24"	ESU212472V4	\$ 454.00
30"	ESU213072V4	470.40
36"	ESU213672V4	519.80
42"	ESU214272V4	585.40
48"	ESU214872V4	610.40
54"	ESU215472V4	676.20
60"	ESU216072V4	721.40
72"	ESU217272V4	811.20

22"	EA212472V4	\$ 363.20
28"	EA213072V4	379.60
34"	EA213672V4	429.00
40"	EA214272V4	494.60
46"	EA214872V4	519.60
52"	EA215472V4	585.40
58"	EA216072V4	630.60
70"	EA217272V4	720.40

24"	ESU212472V5	\$ 522.10
30"	ESU213072V5	542.60
36"	ESU213672V5	604.35
42"	ESU214272V5	686.35
48"	ESU214872V5	717.60
54"	ESU215472V5	799.85
60"	ESU216072V5	856.35
72"	ESU217272V5	968.60

22"	EA212472V5	\$ 431.30
28"	EA213072V5	451.80
34"	EA213672V5	513.55
40"	EA214272V5	595.55
46"	EA214872V5	626.80
52"	EA215472V5	709.05
58"	EA216072V5	765.55
70"	EA217272V5	877.80

24"
DEPTH

24"	ESU242472V4	\$ 465.30
30"	ESU243072V4	490.90
36"	ESU243672V4	533.90
42"	ESU244272V4	592.70
48"	ESU244872V4	631.10
54"	ESU245472V4	685.90
60"	ESU246072V4	726.70
72"	ESU247272V4	823.10

22"	EA242472V4	\$ 373.75
28"	EA243072V4	399.35
34"	EA243672V4	442.35
40"	EA244272V4	501.15
46"	EA244872V4	539.55
52"	EA245472V4	594.35
58"	EA246072V4	635.15
70"	EA247272V4	731.55

24"	ESU242472V5	\$ 535.85
30"	ESU243072V5	567.85
36"	ESU243672V5	621.60
42"	ESU244272V5	695.10
48"	ESU244872V5	743.10
54"	ESU245472V5	811.60
60"	ESU246072V5	862.60
72"	ESU247272V5	983.10

22"	EA242472V5	\$ 444.30
28"	EA243072V5	476.30
34"	EA243672V5	530.05
40"	EA244272V5	603.55
46"	EA244872V5	651.55
52"	EA245472V5	720.05
58"	EA246072V5	771.05
70"	EA247272V5	891.55

Color: Brushed Graphite (580).

S4

4-Shelf Solid Stationary Starter and Add-On Units

VS4

4-Shelf Vented and Solid Stationary Starter and Add-On Units

(3 Vented + 1 Solid)

Units ship complete in 1 box and include 1 or 2 factory assembled post kits, traverses, dovetails and shelf plates.

72"
HEIGHT

Starter

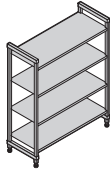

Add-On

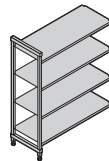

18"
DEPTH

LENGTH	CODE	LIST PRICE EA.
24"	ESU182472S4	\$ 443.90
30"	ESU183072S4	445.30
36"	ESU183672S4	490.70
42"	ESU184272S4	552.70
48"	ESU184872S4	572.50
54"	ESU185472S4	634.90
60"	ESU186072S4	678.30
72"	ESU187272S4	758.50

LENGTH	CODE	LIST PRICE EA.
22"	EA182472S4	\$ 355.25
28"	EA183072S4	356.65
34"	EA183672S4	402.05
40"	EA184272S4	464.05
46"	EA184872S4	483.85
52"	EA185472S4	546.25
58"	EA186072S4	589.65
70"	EA187272S4	669.85

Starter

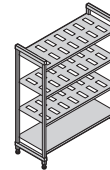

Add-On

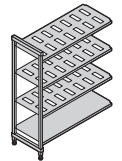

LENGTH	CODE	LIST PRICE EA.
24"	ESU182472VS4	\$ 426.65
30"	ESU183072VS4	436.75
36"	ESU183672VS4	480.20
42"	ESU184272VS4	539.20
48"	ESU184872VS4	559.75
54"	ESU185472VS4	618.55
60"	ESU186072VS4	659.10
72"	ESU187272VS4	737.05

LENGTH	CODE	LIST PRICE EA.
22"	EA182472VS4	\$ 338.00
28"	EA183072VS4	348.10
34"	EA183672VS4	391.55
40"	EA184272VS4	450.55
46"	EA184872VS4	471.10
52"	EA185472VS4	529.90
58"	EA186072VS4	570.45
70"	EA187272VS4	648.40

21"
DEPTH

24"	ESU212472S4	\$ 468.20
30"	ESU213072S4	486.00
36"	ESU213672S4	538.20
42"	ESU214272S4	605.20
48"	ESU214872S4	637.20
54"	ESU215472S4	704.20
60"	ESU216072S4	750.80
72"	ESU217272S4	848.40

22"	EA212472S4	\$ 377.40
28"	EA213072S4	395.20
34"	EA213672S4	447.40
40"	EA214272S4	514.40
46"	EA214872S4	546.40
52"	EA215472S4	613.40
58"	EA216072S4	660.00
70"	EA217272S4	757.60

24"	ESU212472VS4	\$ 457.55
30"	ESU213072VS4	474.30
36"	ESU213672VS4	524.40
42"	ESU214272VS4	590.35
48"	ESU214872VS4	617.10
54"	ESU215472VS4	683.20
60"	ESU216072VS4	728.75
72"	ESU217272VS4	820.50

22"	EA212472VS4	\$ 366.75
28"	EA213072VS4	383.50
34"	EA213672VS4	433.60
40"	EA214272VS4	499.55
46"	EA214872VS4	526.30
52"	EA215472VS4	592.40
58"	EA216072VS4	637.95
70"	EA217272VS4	729.70

24"
DEPTH

24"	ESU242472S4	\$ 477.30
30"	ESU243072S4	507.90
36"	ESU243672S4	559.30
42"	ESU244272S4	618.70
48"	ESU244872S4	660.10
54"	ESU245472S4	720.30
60"	ESU246072S4	765.70
72"	ESU247272S4	865.90

22"	EA242472S4	\$ 385.75
28"	EA243072S4	416.35
34"	EA243672S4	467.75
40"	EA244272S4	527.15
46"	EA244872S4	568.55
52"	EA245472S4	628.75
58"	EA246072S4	674.15
70"	EA247272S4	774.35

24"	ESU242472VS4	\$ 468.30
30"	ESU243072VS4	495.15
36"	ESU243672VS4	540.25
42"	ESU244272VS4	599.20
48"	ESU244872VS4	638.35
54"	ESU245472VS4	694.50
60"	ESU246072VS4	736.45
72"	ESU247272VS4	833.80

22"	EA242472VS4	\$ 376.75
28"	EA243072VS4	403.60
34"	EA243672VS4	448.70
40"	EA244272VS4	507.65
46"	EA244872VS4	546.80
52"	EA245472VS4	602.95
58"	EA246072VS4	644.90
70"	EA247272VS4	742.25

Color: Brushed Graphite (580).

V4

4-Shelf Vented Stationary Starter and Add-On Units

V5

5-Shelf Vented Stationary Starter and Add-On Units

Units ship complete in 1 box and include 1 or 2 factory assembled post kits, traverses, dovetails and shelf plates.

84"
HEIGHT

18"
DEPTH

Starter

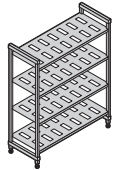

Add-On

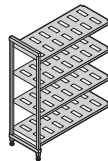

LENGTH	CODE	LIST PRICE EA.
24"	ESU182484V4	\$ 448.50
30"	ESU183084V4	461.50
36"	ESU183684V4	504.30
42"	ESU184284V4	562.30
48"	ESU184884V4	583.10
54"	ESU185484V4	640.70
60"	ESU186084V4	680.30
72"	ESU187284V4	757.50

LENGTH	CODE	LIST PRICE EA.
22"	EA182484V4	\$ 346.05
28"	EA183084V4	359.05
34"	EA183684V4	401.85
40"	EA184284V4	459.85
46"	EA184884V4	480.65
52"	EA185484V4	538.25
58"	EA186084V4	577.85
70"	EA187284V4	655.05

Starter

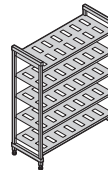

Add-On

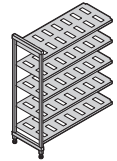

LENGTH	CODE	LIST PRICE EA.
24"	ESU182484V5	\$ 509.40
30"	ESU183084V5	525.65
36"	ESU183684V5	579.15
42"	ESU184284V5	651.65
48"	ESU184884V5	677.65
54"	ESU185484V5	749.65
60"	ESU186084V5	799.15
72"	ESU187284V5	895.65

LENGTH	CODE	LIST PRICE EA.
22"	EA182484V5	\$ 406.95
28"	EA183084V5	423.20
34"	EA183684V5	476.70
40"	EA184284V5	549.20
46"	EA184884V5	575.20
52"	EA185484V5	647.20
58"	EA186084V5	696.70
70"	EA187284V5	793.20

21"
DEPTH

LENGTH	CODE	LIST PRICE EA.
24"	ESU212484V4	\$ 481.50
30"	ESU213084V4	497.90
36"	ESU213684V4	547.30
42"	ESU214284V4	612.90
48"	ESU214884V4	637.90
54"	ESU215484V4	703.70
60"	ESU216084V4	748.90
72"	ESU217284V4	838.70

LENGTH	CODE	LIST PRICE EA.
22"	EA212484V4	\$ 376.95
28"	EA213084V4	393.35
34"	EA213684V4	442.75
40"	EA214284V4	508.35
46"	EA214884V4	533.35
52"	EA215484V4	599.15
58"	EA216084V4	644.35
70"	EA217284V4	734.15

LENGTH	CODE	LIST PRICE EA.
24"	ESU212484V5	\$ 549.60
30"	ESU213084V5	570.10
36"	ESU213684V5	631.85
42"	ESU214284V5	713.85
48"	ESU214884V5	745.10
54"	ESU215484V5	827.35
60"	ESU216084V5	883.85
72"	ESU217284V5	996.10

LENGTH	CODE	LIST PRICE EA.
22"	EA212484V5	\$ 445.05
28"	EA213084V5	465.55
34"	EA213684V5	527.30
40"	EA214284V5	609.30
46"	EA214884V5	640.55
52"	EA215484V5	722.80
58"	EA216084V5	779.30
70"	EA217284V5	891.55

24"
DEPTH

LENGTH	CODE	LIST PRICE EA.
24"	ESU242484V4	\$ 492.80
30"	ESU243084V4	518.40
36"	ESU243684V4	561.40
42"	ESU244284V4	620.20
48"	ESU244884V4	658.60
54"	ESU245484V4	713.40
60"	ESU246084V4	754.20
72"	ESU247284V4	850.60

LENGTH	CODE	LIST PRICE EA.
22"	EA242484V4	\$ 387.50
28"	EA243084V4	413.10
34"	EA243684V4	456.10
40"	EA244284V4	514.90
46"	EA244884V4	553.30
52"	EA245484V4	608.10
58"	EA246084V4	648.90
70"	EA247284V4	745.30

LENGTH	CODE	LIST PRICE EA.
24"	ESU242484V5	\$ 563.35
30"	ESU243084V5	595.35
36"	ESU243684V5	649.10
42"	ESU244284V5	722.60
48"	ESU244884V5	770.60
54"	ESU245484V5	839.10
60"	ESU246084V5	890.10
72"	ESU247284V5	1,010.60

LENGTH	CODE	LIST PRICE EA.
22"	EA242484V5	\$ 458.05
28"	EA243084V5	490.05
34"	EA243684V5	543.80
40"	EA244284V5	617.30
46"	EA244884V5	665.30
52"	EA245484V5	733.80
58"	EA246084V5	784.80
70"	EA247284V5	905.30

Color: Brushed Graphite (580).

S4

4-Shelf Solid Stationary Starter and Add-On Units

S5

5-Shelf Solid Stationary Starter and Add-On Units

Units ship complete in 1 box and include 1 or 2 factory assembled post kits, traverses, dovetails and shelf plates.

84"

HEIGHT

Starter

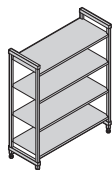

Add-On

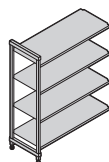

18"

DEPTH

LENGTH	CODE	LIST PRICE EA.
24"	ESU182484S4	\$ 471.50
30"	ESU183084S4	472.90
36"	ESU183684S4	518.30
42"	ESU184284S4	580.30
48"	ESU184884S4	600.10
54"	ESU185484S4	662.50
60"	ESU186084S4	705.90
72"	ESU187284S4	786.10

LENGTH	CODE	LIST PRICE EA.
22"	EA182484S4	\$ 369.05
28"	EA183084S4	370.45
34"	EA183684S4	415.85
40"	EA184284S4	477.85
46"	EA184884S4	497.65
52"	EA185484S4	560.05
58"	EA186084S4	603.45
70"	EA187284S4	683.65

Starter

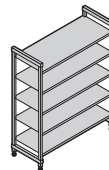

Add-On

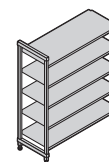

LENGTH	CODE	LIST PRICE EA.
24"	ESU182484S5	\$ 538.15
30"	ESU183084S5	539.90
36"	ESU183684S5	596.65
42"	ESU184284S5	674.15
48"	ESU184884S5	698.90
54"	ESU185484S5	776.90
60"	ESU186084S5	831.15
72"	ESU187284S5	931.40

LENGTH	CODE	LIST PRICE EA.
22"	EA182484S5	\$ 435.70
28"	EA183084S5	437.45
34"	EA183684S5	494.20
40"	EA184284S5	571.70
46"	EA184884S5	596.45
52"	EA185484S5	674.45
58"	EA186084S5	728.70
70"	EA187284S5	828.95

21"

DEPTH

24"	ESU212484S4	\$ 495.70
30"	ESU213084S4	513.50
36"	ESU213684S4	565.70
42"	ESU214284S4	632.70
48"	ESU214884S4	664.70
54"	ESU215484S4	731.70
60"	ESU216084S4	778.30
72"	ESU217284S4	875.90

22"	EA212484S4	\$ 391.15
28"	EA213084S4	408.95
34"	EA213684S4	461.15
40"	EA214284S4	528.15
46"	EA214884S4	560.15
52"	EA215484S4	627.15
58"	EA216084S4	673.75
70"	EA217284S4	771.35

24"	ESU212484S5	\$ 567.35
30"	ESU213084S5	589.60
36"	ESU213684S5	654.85
42"	ESU214284S5	738.60
48"	ESU214884S5	778.60
54"	ESU215484S5	862.35
60"	ESU216084S5	920.60
72"	ESU217284S5	1,042.60

22"	EA212484S5	\$ 462.80
28"	EA213084S5	485.05
34"	EA213684S5	550.30
40"	EA214284S5	634.05
46"	EA214884S5	674.05
52"	EA215484S5	757.80
58"	EA216084S5	816.05
70"	EA217284S5	938.05

24"

DEPTH

24"	ESU242484S4	\$ 504.80
30"	ESU243084S4	535.40
36"	ESU243684S4	586.80
42"	ESU244284S4	646.20
48"	ESU244884S4	687.60
54"	ESU245484S4	747.80
60"	ESU246084S4	793.20
72"	ESU247284S4	893.40

22"	EA242484S4	\$ 399.50
28"	EA243084S4	430.10
34"	EA243684S4	481.50
40"	EA244284S4	540.90
46"	EA244884S4	582.30
52"	EA245484S4	642.50
58"	EA246084S4	687.90
70"	EA247284S4	788.10

24"	ESU242484S5	\$ 578.35
30"	ESU243084S5	616.60
36"	ESU243684S5	680.85
42"	ESU244284S5	755.10
48"	ESU244884S5	806.85
54"	ESU245484S5	882.10
60"	ESU246084S5	938.85
72"	ESU247284S5	1,064.10

22"	EA242484S5	\$ 473.05
28"	EA243084S5	511.30
34"	EA243684S5	575.55
40"	EA244284S5	649.80
46"	EA244884S5	701.55
52"	EA245484S5	776.80
58"	EA246084S5	833.55
70"	EA247284S5	958.80

Color: Brushed Graphite (580).

VS4

4-Shelf Vented and Solid Stationary Starter and Add-On Units

(3 vented + 1 solid)

VS5

5-Shelf Vented and Solid Stationary Starter and Add-On Units

(4 vented + 1 solid)

Units ship complete in 1 box and include 1 or 2 factory assembled post kits, traverses, dovetails and shelf plates.

84"

HEIGHT

Starter

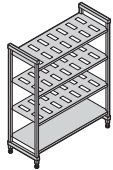

Add-On

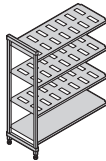
18"
DEPTH

LENGTH	CODE	LIST PRICE EA.
24"	ESU182484VS4	\$ 454.25
30"	ESU183084VS4	464.35
36"	ESU183684VS4	507.80
42"	ESU184284VS4	566.80
48"	ESU184884VS4	587.35
54"	ESU185484VS4	646.15
60"	ESU186084VS4	686.70
72"	ESU187284VS4	764.65

LENGTH	CODE	LIST PRICE EA.
22"	EA182484VS4	\$ 351.80
28"	EA183084VS4	361.90
34"	EA183684VS4	405.35
40"	EA184284VS4	464.35
46"	EA184884VS4	484.90
52"	EA185484VS4	543.70
58"	EA186084VS4	584.25
70"	EA187284VS4	662.20

Starter

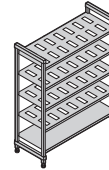

Add-On

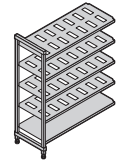

LENGTH	CODE	LIST PRICE EA.
24"	ESU182484VS5	\$ 515.15
30"	ESU183084VS5	528.50
36"	ESU183684VS5	582.65
42"	ESU184284VS5	656.15
48"	ESU184884VS5	681.90
54"	ESU185484VS5	755.10
60"	ESU186084VS5	805.55
72"	ESU187284VS5	902.80

LENGTH	CODE	LIST PRICE EA.
22"	EA182484VS5	\$ 412.70
28"	EA183084VS5	426.05
34"	EA183684VS5	480.20
40"	EA184284VS5	553.70
46"	EA184884VS5	579.45
52"	EA185484VS5	652.65
58"	EA186084VS5	703.10
70"	EA187284VS5	800.35

21"
DEPTH

24"	ESU212484VS4	\$ 485.05
30"	ESU213084VS4	501.80
36"	ESU213684VS4	551.90
42"	ESU214284VS4	617.85
48"	ESU214884VS4	644.60
54"	ESU215484VS4	710.70
60"	ESU216084VS4	756.25
72"	ESU217284VS4	848.00

22"	EA212484VS4	\$ 380.50
28"	EA213084VS4	397.25
34"	EA213684VS4	447.35
40"	EA214284VS4	513.30
46"	EA214884VS4	540.05
52"	EA215484VS4	606.15
58"	EA216084VS4	651.70
70"	EA217284VS4	743.45

24"	ESU212484VS5	\$ 553.15
30"	ESU213084VS5	574.00
36"	ESU213684VS5	636.45
42"	ESU214284VS5	718.80
48"	ESU214884VS5	751.80
54"	ESU215484VS5	834.35
60"	ESU216084VS5	891.20
72"	ESU217284VS5	1,005.40

22"	EA212484VS5	\$ 448.60
28"	EA213084VS5	469.45
34"	EA213684VS5	531.90
40"	EA214284VS5	614.25
46"	EA214884VS5	647.25
52"	EA215484VS5	729.80
58"	EA216084VS5	786.65
70"	EA217284VS5	900.85

24"
DEPTH

24"	ESU242484VS4	\$ 495.80
30"	ESU243084VS4	522.65
36"	ESU243684VS4	567.75
42"	ESU244284VS4	626.70
48"	ESU244884VS4	665.85
54"	ESU245484VS4	722.00
60"	ESU246084VS4	763.95
72"	ESU247284VS4	861.30

22"	EA242484VS4	\$ 390.50
28"	EA243084VS4	417.35
34"	EA243684VS4	462.45
40"	EA244284VS4	521.40
46"	EA244884VS4	560.55
52"	EA245484VS4	616.70
58"	EA246084VS4	658.65
70"	EA247284VS4	756.00

24"	ESU242484VS5	\$ 566.35
30"	ESU243084VS5	599.60
36"	ESU243684VS5	655.45
42"	ESU244284VS5	729.10
48"	ESU244884VS5	777.85
54"	ESU245484VS5	847.70
60"	ESU246084VS5	899.85
72"	ESU247284VS5	1,021.30

22"	EA242484VS5	\$ 461.05
28"	EA243084VS5	494.30
34"	EA243684VS5	550.15
40"	EA244284VS5	623.80
46"	EA244884VS5	672.55
52"	EA245484VS5	742.40
58"	EA246084VS5	794.55
70"	EA247284VS5	916.00

Color: Brushed Graphite (580).

V4

4-Shelf Vented Mobile Starter Units

V5

5-Shelf Vented Mobile Starter Units

Units ship complete in 1 box and include 1 or 2 factory assembled mobile post kits, traverses, dovetails, shelf plates and 4 swivel, total locking casters.

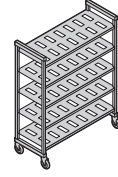
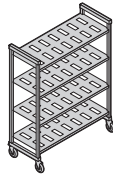

70"

HEIGHT includes 5" casters.

18"

DEPTH

CODE	DIMENSIONS D x L x H	LIST PRICE EA.
EMU183670V4	18" x 36" x 70"	\$ 740.90
EMU184270V4	18" x 42" x 70"	798.70
EMU184870V4	18" x 48" x 70"	819.70
EMU185470V4	18" x 54" x 70"	877.10
EMU186070V4	18" x 60" x 70"	916.70

21"

DEPTH

EMU213670V4	21" x 36" x 70"	\$ 784.00
EMU214270V4	21" x 42" x 70"	849.80
EMU214870V4	21" x 48" x 70"	875.00
EMU215470V4	21" x 54" x 70"	940.40
EMU216070V4	21" x 60" x 70"	985.40

24"

DEPTH

EMU243670V4	24" x 36" x 70"	\$ 798.20
EMU244270V4	24" x 42" x 70"	856.80
EMU244870V4	24" x 48" x 70"	895.20
EMU245470V4	24" x 54" x 70"	950.00
EMU246070V4	24" x 60" x 70"	990.80

78"

HEIGHT includes 5" casters.

18"

DEPTH

CODE	DIMENSIONS D x L x H	LIST PRICE EA.
EMU183678V4	18" x 36" x 78"	\$ 744.90
EMU184278V4	18" x 42" x 78"	802.70
EMU184878V4	18" x 48" x 78"	823.70
EMU185478V4	18" x 54" x 78"	881.10
EMU186078V4	18" x 60" x 78"	920.70

21"

DEPTH

EMU213678V4	21" x 36" x 78"	\$ 787.70
EMU214278V4	21" x 42" x 78"	853.50
EMU214878V4	21" x 48" x 78"	878.70
EMU215478V4	21" x 54" x 78"	944.10
EMU216078V4	21" x 60" x 78"	989.10

24"

DEPTH

EMU243678V4	24" x 36" x 78"	\$ 802.10
EMU244278V4	24" x 42" x 78"	860.70
EMU244878V4	24" x 48" x 78"	899.10
EMU245478V4	24" x 54" x 78"	953.90
EMU246078V4	24" x 60" x 78"	994.70

18"

DEPTH

CODE	DIMENSIONS D x L x H	LIST PRICE EA.
EMU183670V5	18" x 36" x 70"	\$ 822.80
EMU184270V5	18" x 42" x 70"	895.05
EMU184870V5	18" x 48" x 70"	921.30
EMU185470V5	18" x 54" x 70"	993.05
EMU186070V5	18" x 60" x 70"	1,042.55

21"

DEPTH

EMU213670V5	21" x 36" x 70"	\$ 875.55
EMU214270V5	21" x 42" x 70"	957.80
EMU214870V5	21" x 48" x 70"	989.30
EMU215470V5	21" x 54" x 70"	1,071.05
EMU216070V5	21" x 60" x 70"	1,127.30

24"

DEPTH

EMU243670V5	24" x 36" x 70"	\$ 892.95
EMU244270V5	24" x 42" x 70"	966.20
EMU244870V5	24" x 48" x 70"	1,014.20
EMU245470V5	24" x 54" x 70"	1,082.70
EMU246070V5	24" x 60" x 70"	1,133.70

18"

DEPTH

CODE	DIMENSIONS D x L x H	LIST PRICE EA.
EMU183678V5	18" x 36" x 78"	\$ 826.80
EMU184278V5	18" x 42" x 78"	899.05
EMU184878V5	18" x 48" x 78"	925.30
EMU185478V5	18" x 54" x 78"	997.05
EMU186078V5	18" x 60" x 78"	1,046.55

21"

DEPTH

EMU213678V5	21" x 36" x 78"	\$ 879.25
EMU214278V5	21" x 42" x 78"	961.50
EMU214878V5	21" x 48" x 78"	993.00
EMU215478V5	21" x 54" x 78"	1,074.75
EMU216078V5	21" x 60" x 78"	1,131.00

24"

DEPTH

EMU243678V5	24" x 36" x 78"	\$ 896.85
EMU244278V5	24" x 42" x 78"	970.10
EMU244878V5	24" x 48" x 78"	1,018.10
EMU245478V5	24" x 54" x 78"	1,086.60
EMU246078V5	24" x 60" x 78"	1,137.60

Color: Brushed Graphite (580).



V2 2-Shelf Vented Undercounter Stationary Units

Stationary units include 2 factory assembled stationary post kits, 4 stationary traverses, stationary traverse dovetails and shelf plates. Units ship complete in 1 box.

30"
HEIGHT

18"
DEPTH

CODE	DIMENSIONS D x L	LIST PRICE EA.
ESU183630V2	18" x 36"	\$ 298.40
ESU184830V2	18" x 48"	336.70



V2 2-Shelf Vented Undercounter Mobile Units

Mobile units include 2 factory assembled mobile post kits, 4 mobile traverses, mobile traverse dovetails, shelf plates, and 4 premium swivel casters with total locking brake. Units ship complete in 1 box.

27"
HEIGHT includes 5" casters.

14"
DEPTH

CODE	DIMENSIONS D x L	LIST PRICE EA.
EMU142427V2	14" x 24"	\$ 513.60
EMU143627V2	14" x 36"	577.10
EMU144827V2	14" x 48"	616.50



Standard Stationary Post Kits

Ships **unassembled** in 1 box. Includes 2 stationary posts, post connectors and post connector wedges.



30"
HEIGHT

CODE	DIMENSIONS D x H	LIST PRICE EA.
EPK1830	18" x 30"	\$ 76.55

Height is suitable for undercounter or table.



64"
HEIGHT

EPK1464	14" x 64"	\$ 82.80
EPK1864	18" x 64"	86.65
EPK2164	21" x 64"	88.90
EPK2464	24" x 64"	89.60

72"
HEIGHT

EPK1472	14" x 72"	\$ 84.70
EPK1872	18" x 72"	88.65
EPK2172	21" x 72"	90.80
EPK2472	24" x 72"	91.55

84"
HEIGHT

EPK1484	14" x 84"	\$ 98.45
EPK1884	18" x 84"	102.45
EPK2184	21" x 84"	104.55
EPK2484	24" x 84"	105.30

Color: Brushed Graphite (580).

V1

Stationary Single Vented Shelf Kits

Includes 2 stationary shelf traverses, stationary traverse dovetails and vented or solid shelf plates. Fits stationary units only. Ships in 1 box.

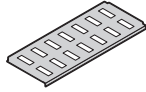

14"
DEPTH

CODE	DIMENSIONS D x L	LIST PRICE EA.
ESK1424V1	14" x 24"	\$ 60.50
ESK1430V1	14" x 30"	63.85
ESK1436V1	14" x 36"	73.40
ESK1442V1	14" x 42"	84.00
ESK1448V1	14" x 48"	93.00
ESK1454V1	14" x 54"	103.55
ESK1460V1	14" x 60"	111.10
ESK1472V1	14" x 72"	130.40

18"
DEPTH

ESK1824V1	18" x 24"	\$ 60.90
ESK1830V1	18" x 30"	64.15
ESK1836V1	18" x 36"	74.85
ESK1842V1	18" x 42"	89.35
ESK1848V1	18" x 48"	94.55
ESK1854V1	18" x 54"	108.95
ESK1860V1	18" x 60"	118.85
ESK1872V1	18" x 72"	138.15

21"
DEPTH

ESK2124V1	21" x 24"	\$ 68.10
ESK2130V1	21" x 30"	72.20
ESK2136V1	21" x 36"	84.55
ESK2142V1	21" x 42"	100.95
ESK2148V1	21" x 48"	107.20
ESK2154V1	21" x 54"	123.65
ESK2160V1	21" x 60"	134.95
ESK2172V1	21" x 72"	157.40

24"
DEPTH

ESK2424V1	24" x 24"	\$ 70.55
ESK2430V1	24" x 30"	76.95
ESK2436V1	24" x 36"	87.70
ESK2442V1	24" x 42"	102.40
ESK2448V1	24" x 48"	112.00
ESK2454V1	24" x 54"	125.70
ESK2460V1	24" x 60"	135.90
ESK2472V1	24" x 72"	160.00

S1

Stationary Single Solid Shelf Kits

Includes 2 stationary shelf traverses, stationary traverse dovetails and vented or solid shelf plates. Fits stationary units only. Ships in 1 box.

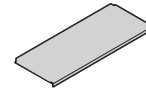

14"
DEPTH

CODE	DIMENSIONS D x L	LIST PRICE EA.
ESK1424S1	14" x 24"	\$ 61.60
ESK1430S1	14" x 30"	65.15
ESK1436S1	14" x 36"	75.35
ESK1442S1	14" x 42"	86.75
ESK1448S1	14" x 48"	95.65
ESK1454S1	14" x 54"	106.95
ESK1460S1	14" x 60"	115.35
ESK1472S1	14" x 72"	135.35

18"
DEPTH

ESK1824S1	18" x 24"	\$ 66.65
ESK1830S1	18" x 30"	67.00
ESK1836S1	18" x 36"	78.35
ESK1842S1	18" x 42"	93.85
ESK1848S1	18" x 48"	98.80
ESK1854S1	18" x 54"	114.40
ESK1860S1	18" x 60"	125.25
ESK1872S1	18" x 72"	145.30

21"
DEPTH

ESK2124S1	21" x 24"	\$ 71.65
ESK2130S1	21" x 30"	76.10
ESK2136S1	21" x 36"	89.15
ESK2142S1	21" x 42"	105.90
ESK2148S1	21" x 48"	113.90
ESK2154S1	21" x 54"	130.65
ESK2160S1	21" x 60"	142.30
ESK2172S1	21" x 72"	166.70

24"
DEPTH

ESK2424S1	24" x 24"	\$ 73.55
ESK2430S1	24" x 30"	81.20
ESK2436S1	24" x 36"	94.05
ESK2442S1	24" x 42"	108.90
ESK2448S1	24" x 48"	119.25
ESK2454S1	24" x 54"	134.30
ESK2460S1	24" x 60"	145.65
ESK2472S1	24" x 72"	170.70

V4 Stationary 4-Shelf Vented Kits

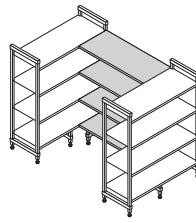

Includes 8 stationary shelf traverses, stationary traverse dovetails and vented or solid shelf plates.
Ships in 1 box. Fits stationary units only. Install with 8 sets of corner connectors (ECC8) to create a U-shape unit.

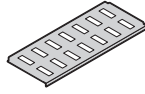

18"
DEPTH

CODE	DIMENSIONS D x L	LIST PRICE EA.
ESK1836V4	18" x 36"	\$ 299.40
ESK1842V4	18" x 42"	357.40
ESK1848V4	18" x 48"	378.20

21"
DEPTH

ESK2136V4	21" x 36"	\$ 338.20
ESK2142V4	21" x 42"	403.80
ESK2148V4	21" x 48"	428.80

24"
DEPTH

ESK2436V4	24" x 36"	\$ 350.80
ESK2442V4	24" x 42"	409.60
ESK2448V4	24" x 48"	448.00

S4 Stationary 4-Shelf Solid Kits

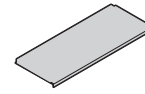

18"
DEPTH

CODE	DIMENSIONS D x L	LIST PRICE EA.
ESK1836S4	18" x 36"	\$ 313.40
ESK1842S4	18" x 42"	375.40
ESK1848S4	18" x 48"	395.20

21"
DEPTH

ESK2136S4	21" x 36"	\$ 356.60
ESK2142S4	21" x 42"	423.60
ESK2148S4	21" x 48"	455.60

24"
DEPTH

ESK2436S4	24" x 36"	\$ 376.20
ESK2442S4	24" x 42"	435.60
ESK2448S4	24" x 48"	477.00

V5 Stationary 5-Shelf Vented Kits

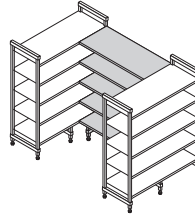

Includes 10 stationary shelf traverses, stationary traverse dovetails and vented or solid shelf plates.
Ships in 1 box. Fits stationary units only. Install with 10 sets of corner connectors (ECC10) to create a U-shape unit.

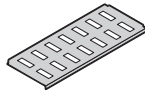

18"
DEPTH

CODE	DIMENSIONS D x L	LIST PRICE EA.
ESK1836V5	18" x 36"	\$ 374.25
ESK1842V5	18" x 42"	446.75
ESK1848V5	18" x 48"	472.75

21"
DEPTH

ESK2136V5	21" x 36"	\$ 422.75
ESK2142V5	21" x 42"	504.75
ESK2148V5	21" x 48"	536.00

24"
DEPTH

ESK2436V5	24" x 36"	\$ 438.50
ESK2442V5	24" x 42"	512.00
ESK2448V5	24" x 48"	560.00

S5 Stationary 5-Shelf Solid Kits

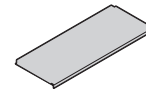

18"
DEPTH

CODE	DIMENSIONS D x L	LIST PRICE EA.
ESK1836S5	18" x 36"	\$ 391.75
ESK1842S5	18" x 42"	469.25
ESK1848S5	18" x 48"	494.00

21"
DEPTH

ESK2136S5	21" x 36"	\$ 445.75
ESK2142S5	21" x 42"	529.50
ESK2148S5	21" x 48"	569.50

24"
DEPTH

ESK2436S5	24" x 36"	\$ 470.25
ESK2442S5	24" x 42"	544.50
ESK2448S5	24" x 48"	596.25

VS4

Stationary 4-Shelf Kits

(3 Vented + 1 Solid)

Includes 8 stationary shelf traverses, stationary traverse dovetails and vented or solid shelf plates. Ships in 1 box.
Fits stationary units only. Install with 8 sets of corner connectors (ECC8) to create a U-shape unit.

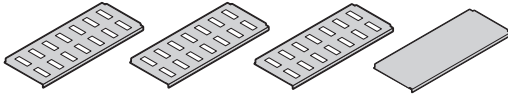

18"
DEPTH

CODE	DIMENSIONS D x L	LIST PRICE EA.
ESK1836VS4	18" x 36"	\$ 302.90
ESK1842VS4	18" x 42"	361.90
ESK1848VS4	18" x 48"	382.45

21"
DEPTH

ESK2136VS4	21" x 36"	\$ 342.80
ESK2142VS4	21" x 42"	408.75
ESK2148VS4	21" x 48"	435.50

24"
DEPTH

ESK2436VS4	24" x 36"	\$ 357.15
ESK2442VS4	24" x 42"	416.10
ESK2448VS4	24" x 48"	455.25

VS5

Stationary 5-Shelf Kits

(4 Vented + 1 Solid)

Includes 10 stationary shelf traverses, stationary traverse dovetails and vented or solid shelf plates. Ships in 1 box.
Fits stationary units only. Install with 10 sets of corner connectors (ECC10) to create a U-shape unit.

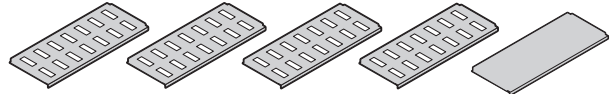

18"
DEPTH

CODE	DIMENSIONS D x L	LIST PRICE EA.
ESK1836VS5	18" x 36"	\$ 377.75
ESK1842VS5	18" x 42"	451.25
ESK1848VS5	18" x 48"	477.00

21"
DEPTH

ESK2136VS5	21" x 36"	\$ 427.35
ESK2142VS5	21" x 42"	509.70
ESK2148VS5	21" x 48"	542.70

24"
DEPTH

ESK2436VS5	24" x 36"	\$ 444.85
ESK2442VS5	24" x 42"	518.50
ESK2448VS5	24" x 48"	567.25

Color: Brushed Graphite (580).



Mobile Post Kits

Ships **unassembled** in 1 box. Includes 2 mobile posts, post connectors, post connector wedges and 2 swivel, total locking casters.

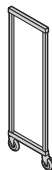

70"
HEIGHT

CODE	DIMENSIONS D x L	LIST PRICE EA.
EMPK1870	18" x 70"	\$ 206.65
EMPK2170	21" x 70"	208.90
EMPK2470	24" x 70"	209.60

78"
HEIGHT

EMPK1878	18" x 78"	\$ 208.65
EMPK2178	21" x 78"	210.75
EMPK2478	24" x 78"	211.55

Color: Brushed Graphite (580).

Donut Bumper

Offers added protection during transport and when maneuvering mobile units into place against walls or alongside other units for storage.

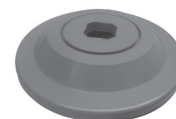

CODE	DIAMETER	LIST PRICE EA.
CSMHDDB	5"	\$ 11.00

Case Pack: 4 Color: Gray (000).

V1

Mobile Single Vented Shelf Kits

Includes 2 mobile shelf traverses, mobile traverse dovetails and vented shelf plates. Fits mobile units only. Ships in 1 box.

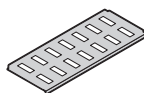

18"
DEPTH

CODE	DIMENSIONS D x L	LIST PRICE EA.
EMSK1836V1	18" x 36"	\$ 81.90
EMSK1842V1	18" x 42"	96.35
EMSK1848V1	18" x 48"	101.60
EMSK1854V1	18" x 54"	115.95
EMSK1860V1	18" x 60"	125.85

21"
DEPTH

EMSK2136V1	21" x 36"	\$ 91.55
EMSK2142V1	21" x 42"	108.00
EMSK2148V1	21" x 48"	114.30
EMSK2154V1	21" x 54"	130.65
EMSK2160V1	21" x 60"	141.90

24"
DEPTH

EMSK2436V1	24" x 36"	\$ 94.75
EMSK2442V1	24" x 42"	109.40
EMSK2448V1	24" x 48"	119.00
EMSK2454V1	24" x 54"	132.70
EMSK2460V1	24" x 60"	142.90

Color: Brushed Graphite (580).

S1

Mobile Single Solid Shelf Kits

Includes 2 mobile shelf traverses, mobile traverse dovetails and solid shelf plates. Fits mobile units only. Ships in 1 box.

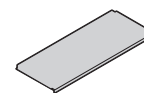

18"
DEPTH

CODE	DIMENSIONS D x L	LIST PRICE EA.
EMSK1836S1	18" x 36"	\$ 85.40
EMSK1842S1	18" x 42"	100.80
EMSK1848S1	18" x 48"	105.85
EMSK1854S1	18" x 54"	121.35
EMSK1860S1	18" x 60"	132.25

21"
DEPTH

EMSK2136S1	21" x 36"	\$ 96.20
EMSK2142S1	21" x 42"	112.90
EMSK2148S1	21" x 48"	120.95
EMSK2154S1	21" x 54"	137.65
EMSK2160S1	21" x 60"	149.25

24"
DEPTH

EMSK2436S1	24" x 36"	\$ 101.00
EMSK2442S1	24" x 42"	115.90
EMSK2448S1	24" x 48"	126.35
EMSK2454S1	24" x 54"	141.35
EMSK2460S1	24" x 60"	152.65

Corner Connectors

Unique patented design ensures maximum shelf space utilization. Use 1 set per shelf to connect starter and add-on units in corners. Connect 4 or 5 intermediate shelves between 2 starter units (2 sets required per shelf). Available as a single set or 8 or 10 set packs.

CODE	DESCRIPTION	LIST PRICE EA.
ECC1	1 Set for 1 shelf	\$ 5.95
ECC8	8 Sets for 4 shelves	47.60
ECC10	10 Sets for 5 shelves	59.50

Color: Brushed Graphite (580).

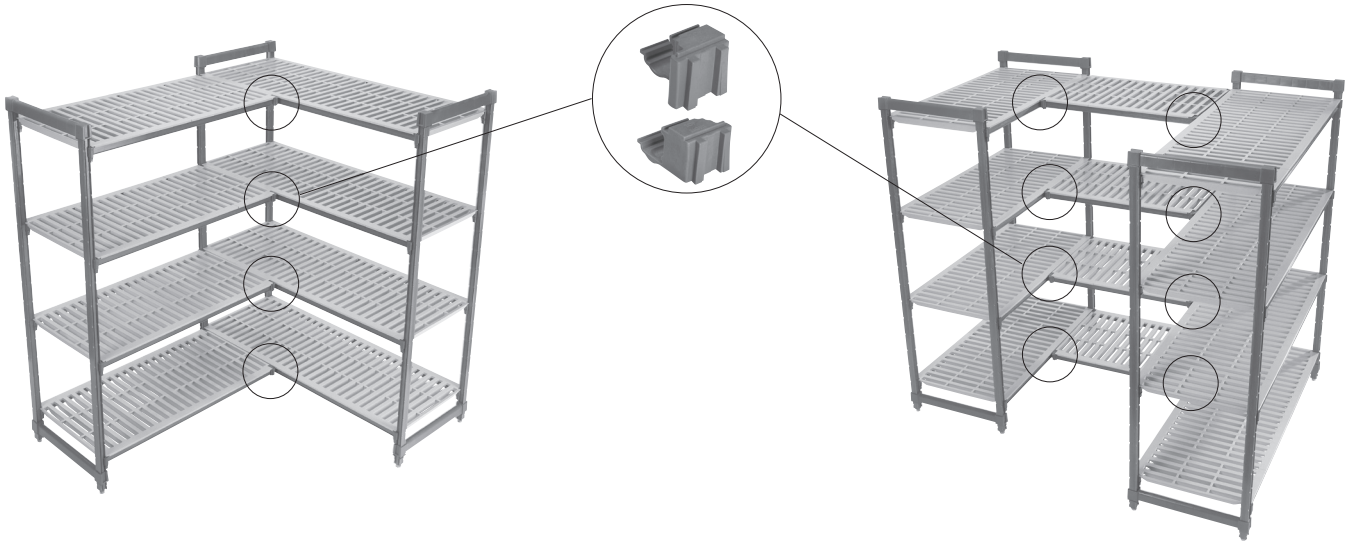

Bottom Shelf Dunnage Stands

Increase weight bearing capacity on bottom shelf only. Add to any shelf length. Highly recommended for starter units 54" and longer and all corner units, intermediate units and units specified for heavier load volume on and off bottom shelves.

CODE	DIMENSIONS D x H	LIST PRICE EA.
Dunnage Stand – Low (bottom shelf installed on lowest set of open post locations for dovetails)		
EDS14H6	14" x 6½"	\$ 52.80
EDS18H6	18" x 6½"	54.50
EDS21H6	21" x 6½"	55.95
EDS24H6	24" x 6½"	57.25
Dunnage Stand – Tall (bottom shelf installed up on 2nd set of open post locations for dovetails)		
EDS14H10	14" x 10½"	57.60
EDS18H10	18" x 10½"	59.30
EDS21H10	21" x 10½"	60.70
EDS24H10	24" x 10½"	62.05

Case Pack: 1 Color: Brushed Graphite (580).

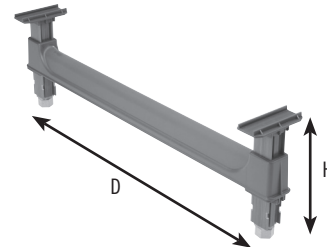
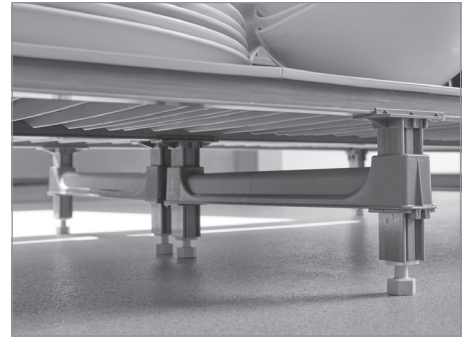

Bottom Shelf with Dunnage Stand

UNIT LENGTH	WEIGHT BEARING
Standard Unit	
24" - 48"	1,200 lbs.
54" - 72"	900
Corner Unit with 2 Dunnage Stands	
24" - 48"	600

Shelf Traverses

Available in single or double packs, stationary or mobile. Use two traverses to add an open shelf for divider bars or drying cradles. Add one stationary traverse onto back posts of a stationary unit for extra support when placing rolling equipment under the first shelf. Traverse dovetails included.

Stationary

LENGTH	SINGLE PACK CODE*	LIST PRICE EA.	DOUBLE PACK CODE**	LIST PRICE EA.
24"	ETR24	\$ 28.30	ETR242PK	\$ 53.90
30"	ETR30	30.60	ETR302PK	58.40
36"	ETR36	31.80	ETR362PK	60.70
42"	ETR42	34.00	ETR422PK	64.80
48"	ETR48	37.10	ETR482PK	70.70
54"	ETR54	40.20	ETR542PK	76.70
60"	ETR60	43.30	ETR602PK	82.70
72"	ETR72	49.50	—	—

*Case Pack: 1 **Case Pack: 2 Color: Brushed Graphite (580).

Mobile

LENGTH	SINGLE PACK CODE*	LIST PRICE EA.	DOUBLE PACK CODE**	LIST PRICE EA.
36"	EMTR36	\$ 43.50	EMTR362PK	\$ 69.00
42"	EMTR42	47.15	EMTR422PK	74.80
48"	EMTR48	50.75	EMTR482PK	80.50
54"	EMTR54	54.35	EMTR542PK	86.20
60"	EMTR60	58.00	EMTR602PK	92.00

*Case Pack: 1 **Case Pack: 2 Color: Brushed Graphite (580).



Stationary Traverse



Mobile Traverse



CAMSHELVING

BASICS® PLUS

series

STATIONARY

WHY CHOOSE BASICS PLUS?

Just because the budget is tight and storage needs are less rigorous, it doesn't mean that shelving performance and storage efficiencies should be compromised. Basics Plus Series is made from the same high performing, strong composite material as Elements Series and has the same design features. It's lighter in weight and less in cost but still strong enough to handle light to medium storage demands.



COMPONENT

Post Connectors, Corner Connectors, Floor Fastener, Wall Fastener, Shelf Rails, Single Shelf Security Cage, Shelf Divider Panels and Identification Tags are not NSF listed.

Stationary Unit Sizes

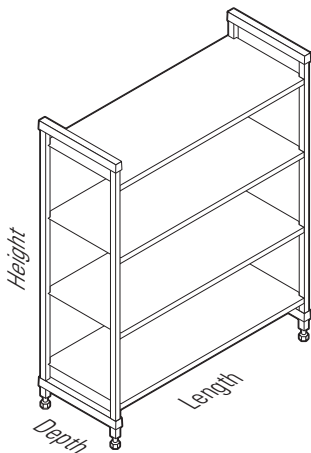

3 Depths		
18"	21"	24"
6 Lengths		
30"	36"	42"
48"	54"	60"
3 Heights		
64"	72"	84"



Weight Bearing Capacity

Weight must be evenly distributed across the entire shelf.

		UNIT LENGTH 30" – 48"	UNIT LENGTH 54" – 60"
SINGLE UNIT	Unit only	1,800 lbs.	1,800 lbs.
	Shelf only	700	500
	Unit with dunnage stand*	2,100	2,100
	Bottom shelf with dunnage stand*	1,000	800
CORNER UNIT** With 2 Dunnage Stands required	Unit only	1,350	—
	Shelf only	300	—
	Bottom shelf with dunnage stands*	450	—

*Dunnage Stands add stability and increase weight bearing capacity on bottom shelf only. Highly recommended for Starter Units 54" and longer, all Corner Units, U-Shape Units and units specified for heavier loads. (See Overall Length Quick Reference Guide).

**Corner connectors are for use only with shelves 30" - 48" long.



CAMSHELVING BASICS PLUS® SERIES – STARTER AND ADD-ON UNITS

V4 4-Shelf Vented Stationary Starter and Add-On Units

HEIGHTS	DEPTHS	LENGTHS	
3	3	6	
64"	18"	30"	48"
72"	21"	36"	54"
84"	24"	42"	60"

V5 5-Shelf Vented Stationary Starter and Add-On Units

HEIGHTS	DEPTHS	LENGTHS	
3	3	6	
64"	18"	30"	48"
72"	21"	36"	54"
84"	24"	42"	60"

S4 4-Shelf Solid Stationary Starter and Add-On Units

HEIGHTS	DEPTHS	LENGTHS	
3	3	6	
64"	18"	30"	48"
72"	21"	36"	54"
84"	24"	42"	60"

S5 5-Shelf Solid Stationary Starter and Add-On Units

HEIGHT	DEPTHS	LENGTHS	
1	3	6	
84"	18"	30"	48"
	21"	36"	54"
	24"	42"	60"

VS4 4-Shelf Vented and Solid Stationary Starter and Add-On Units (3 vented + 1 solid)

HEIGHTS	DEPTHS	LENGTHS	
3	3	6	
64"	18"	30"	48"
72"	21"	36"	54"
84"	24"	42"	60"

VS5 5-Shelf Vented and Solid Stationary Starter and Add-On Units (4 vented + 1 solid)

HEIGHT	DEPTHS	LENGTHS	
1	3	6	
84"	18"	30"	48"
	21"	36"	54"
	24"	42"	60"

V4

4-Shelf Vented Stationary Starter and Add-On Units

V5

5-Shelf Vented Stationary Starter and Add-On Units

Units ship complete in 1 box and include 1 or 2 factory assembled post kits, traverses, dovetails and shelf plates.

64"

HEIGHT

18"

DEPTH

Starter

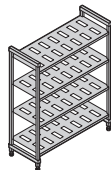

Add-On

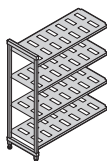

LENGTH	CODE	LIST PRICE EA.
30"	CBU183064V4	\$ 344.30
36"	CBU183664V4	378.10
42"	CBU184264V4	424.70
48"	CBU184864V4	441.30
54"	CBU185464V4	487.50
60"	CBU186064V4	518.90

LENGTH	CODE	LIST PRICE EA.
28¼"	CBA183064V4	\$ 274.95
34¼"	CBA183664V4	308.75
40¼"	CBA184264V4	355.35
46¼"	CBA184864V4	371.95
52¼"	CBA185464V4	418.15
58¼"	CBA186064V4	449.55

Starter

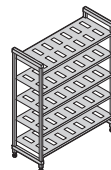

Add-On

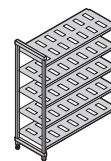

LENGTH	CODE	LIST PRICE EA.
30"	CBU183064V5	\$ 395.70
36"	CBU183664V5	437.95
42"	CBU184264V5	496.20
48"	CBU184864V5	516.95
54"	CBU185464V5	574.70
60"	CBU186064V5	613.95

LENGTH	CODE	LIST PRICE EA.
28¼"	CBA183064V5	\$ 326.35
34¼"	CBA183664V5	368.60
40¼"	CBA184264V5	426.85
46¼"	CBA184864V5	447.60
52¼"	CBA185464V5	505.35
58¼"	CBA186064V5	544.60

21"

DEPTH

30"	CBU213064V4	\$ 373.20
36"	CBU213664V4	412.80
42"	CBU214264V4	465.40
48"	CBU214864V4	485.20
54"	CBU215464V4	538.20
60"	CBU216064V4	574.00

28¼"	CBA213064V4	\$ 302.10
34¼"	CBA213664V4	341.70
40¼"	CBA214264V4	394.30
46¼"	CBA214864V4	414.10
52¼"	CBA215464V4	467.10
58¼"	CBA216064V4	502.90

30"	CBU213064V5	\$ 430.95
36"	CBU213664V5	480.45
42"	CBU214264V5	546.20
48"	CBU214864V5	570.95
54"	CBU215464V5	637.20
60"	CBU216064V5	681.95

28¼"	CBA213064V5	\$ 359.85
34¼"	CBA213664V5	409.35
40¼"	CBA214264V5	475.10
46¼"	CBA214864V5	499.85
52¼"	CBA215464V5	566.10
58¼"	CBA216064V5	610.85

24"

DEPTH

30"	CBU243064V4	\$ 389.60
36"	CBU243664V4	424.20
42"	CBU244264V4	471.00
48"	CBU244864V4	501.80
54"	CBU245464V4	545.80
60"	CBU246064V4	578.20

28¼"	CBA243064V4	\$ 317.90
34¼"	CBA243664V4	352.50
40¼"	CBA244264V4	399.30
46¼"	CBA244864V4	430.10
52¼"	CBA245464V4	474.10
58¼"	CBA246064V4	506.50

30"	CBU243064V5	\$ 451.15
36"	CBU243664V5	494.40
42"	CBU244264V5	552.90
48"	CBU244864V5	591.40
54"	CBU245464V5	646.40
60"	CBU246064V5	686.90

28¼"	CBA243064V5	\$ 379.45
34¼"	CBA243664V5	422.70
40¼"	CBA244264V5	481.20
46¼"	CBA244864V5	519.70
52¼"	CBA245464V5	574.70
58¼"	CBA246064V5	615.20

S4

4-Shelf Solid Stationary Starter and Add-On Units

VS4

4-Shelf Vented and Solid Stationary Starter and Add-On Units

(3 Vented + 1 Solid)

Units ship complete in 1 box and include 1 or 2 factory assembled post kits, traverses, dovetails and shelf plates.

64"
HEIGHT

Starter

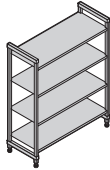

Add-On

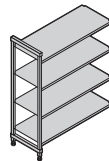

18"
DEPTH

LENGTH	CODE	LIST PRICE EA.
30"	CBU183064S4	\$ 353.10
36"	CBU183664S4	389.50
42"	CBU184264S4	439.10
48"	CBU184864S4	454.70
54"	CBU185464S4	504.70
60"	CBU186064S4	539.50

LENGTH	CODE	LIST PRICE EA.
28¼"	CBA183064S4	\$ 283.75
34¼"	CBA183664S4	320.15
40¼"	CBA184264S4	369.75
46¼"	CBA184864S4	385.35
52¼"	CBA185464S4	435.35
58¼"	CBA186064S4	470.15

Starter

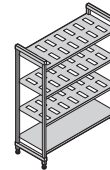

Add-On

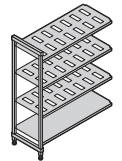

LENGTH	CODE	LIST PRICE EA.
30"	CBU183064VS4	\$ 346.50
36"	CBU183664VS4	380.95
42"	CBU184264VS4	428.30
48"	CBU184864VS4	444.65
54"	CBU185464VS4	491.80
60"	CBU186064VS4	524.05

LENGTH	CODE	LIST PRICE EA.
28¼"	CBA183064VS4	\$ 277.15
34¼"	CBA183664VS4	311.60
40¼"	CBA184264VS4	358.95
46¼"	CBA184864VS4	375.30
52¼"	CBA185464VS4	422.45
58¼"	CBA186064VS4	454.70

21"
DEPTH

30"	CBU213064S4	\$ 385.60
36"	CBU213664S4	427.60
42"	CBU214264S4	481.00
48"	CBU214864S4	506.80
54"	CBU215464S4	560.40
60"	CBU216064S4	597.40

28¼"	CBA213064S4	\$ 314.50
34¼"	CBA213664S4	356.50
40¼"	CBA214264S4	409.90
46¼"	CBA214864S4	435.70
52¼"	CBA215464S4	489.30
58¼"	CBA216064S4	526.30

30"	CBU213064VS4	\$ 376.30
36"	CBU213664VS4	416.50
42"	CBU214264VS4	469.30
48"	CBU214864VS4	490.60
54"	CBU215464VS4	543.75
60"	CBU216064VS4	579.85

28¼"	CBA213064VS4	\$ 305.20
34¼"	CBA213664VS4	345.40
40¼"	CBA214264VS4	398.20
46¼"	CBA214864VS4	419.50
52¼"	CBA215464VS4	472.65
58¼"	CBA216064VS4	508.75

24"
DEPTH

30"	CBU243064S4	\$ 403.40
36"	CBU243664S4	444.40
42"	CBU244264S4	492.00
48"	CBU244864S4	525.20
54"	CBU245464S4	573.20
60"	CBU246064S4	609.40

28¼"	CBA243064S4	\$ 331.70
34¼"	CBA243664S4	372.70
40¼"	CBA244264S4	420.30
46¼"	CBA244864S4	453.50
52¼"	CBA245464S4	501.50
58¼"	CBA246064S4	537.70

30"	CBU243064VS4	\$ 393.05
36"	CBU243664VS4	429.25
42"	CBU244264VS4	476.25
48"	CBU244864VS4	507.65
54"	CBU245464VS4	552.65
60"	CBU246064VS4	586.00

28¼"	CBA243064VS4	\$ 321.35
34¼"	CBA243664VS4	357.55
40¼"	CBA244264VS4	404.55
46¼"	CBA244864VS4	435.95
52¼"	CBA245464VS4	480.95
58¼"	CBA246064VS4	514.30

Color: Brushed Graphite (580).

V4

4-Shelf Vented Stationary Starter and Add-On Units

V5

5-Shelf Vented Stationary Starter and Add-On Units

Units ship complete in 1 box and include 1 or 2 factory assembled post kits, traverses, dovetails and shelf plates.

72"
HEIGHT

18"
DEPTH

Starter

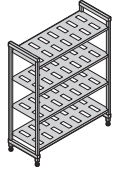

Add-On

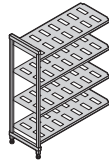

LENGTH	CODE	LIST PRICE EA.
30"	CBU183072V4	\$ 347.40
36"	CBU183672V4	381.20
42"	CBU184272V4	427.80
48"	CBU184872V4	444.40
54"	CBU185472V4	490.60
60"	CBU186072V4	522.00

LENGTH	CODE	LIST PRICE EA.
28¼"	CBA183072V4	\$ 276.50
34¼"	CBA183672V4	310.30
40¼"	CBA184272V4	356.90
46¼"	CBA184872V4	373.50
52¼"	CBA185472V4	419.70
58¼"	CBA186072V4	451.10

Starter

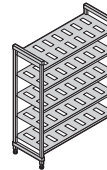

Add-On

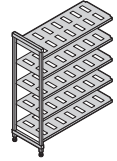

LENGTH	CODE	LIST PRICE EA.
30"	CBU183072V5	\$ 398.80
36"	CBU183672V5	441.05
42"	CBU184272V5	499.30
48"	CBU184872V5	520.05
54"	CBU185472V5	577.80
60"	CBU186072V5	617.05

LENGTH	CODE	LIST PRICE EA.
28¼"	CBA183072V5	\$ 327.90
34¼"	CBA183672V5	370.15
40¼"	CBA184272V5	428.40
46¼"	CBA184872V5	449.15
52¼"	CBA185472V5	506.90
58¼"	CBA186072V5	546.15

21"
DEPTH

30"	CBU213072V4	\$ 376.20
36"	CBU213672V4	415.80
42"	CBU214272V4	468.40
48"	CBU214872V4	488.20
54"	CBU215472V4	541.20
60"	CBU216072V4	577.00

28¼"	CBA213072V4	\$ 303.60
34¼"	CBA213672V4	343.20
40¼"	CBA214272V4	395.80
46¼"	CBA214872V4	415.60
52¼"	CBA215472V4	468.60
58¼"	CBA216072V4	504.40

30"	CBU213072V5	\$ 433.95
36"	CBU213672V5	483.45
42"	CBU214272V5	549.20
48"	CBU214872V5	573.95
54"	CBU215472V5	640.20
60"	CBU216072V5	684.95

28¼"	CBA213072V5	\$ 361.35
34¼"	CBA213672V5	410.85
40¼"	CBA214272V5	476.60
46¼"	CBA214872V5	501.35
52¼"	CBA215472V5	567.60
58¼"	CBA216072V5	612.35

24"
DEPTH

30"	CBU243072V4	\$ 392.70
36"	CBU243672V4	427.30
42"	CBU244272V4	474.10
48"	CBU244872V4	504.90
54"	CBU245472V4	548.90
60"	CBU246072V4	581.30

28¼"	CBA243072V4	\$ 319.45
34¼"	CBA243672V4	354.05
40¼"	CBA244272V4	400.85
46¼"	CBA244872V4	431.65
52¼"	CBA245472V4	475.65
58¼"	CBA246072V4	508.05

30"	CBU243072V5	\$ 454.25
36"	CBU243672V5	497.50
42"	CBU244272V5	556.00
48"	CBU244872V5	594.50
54"	CBU245472V5	649.50
60"	CBU246072V5	690.00

28¼"	CBA243072V5	\$ 381.00
34¼"	CBA243672V5	424.25
40¼"	CBA244272V5	482.75
46¼"	CBA244872V5	521.25
52¼"	CBA245472V5	576.25
58¼"	CBA246072V5	616.75

S4

4-Shelf Solid Stationary Starter and Add-On Units

VS4

4-Shelf Vented and Solid Stationary Starter and Add-On Units

(3 Vented + 1 Solid)

Units ship complete in 1 box and include 1 or 2 factory assembled post kits, traverses, dovetails and shelf plates.

72"
HEIGHT

Starter

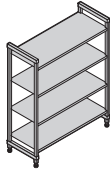

Add-On

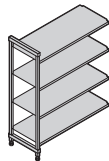

18"
DEPTH

LENGTH	CODE	LIST PRICE EA.
30"	CBU183072S4	\$ 356.20
36"	CBU183672S4	392.60
42"	CBU184272S4	442.20
48"	CBU184872S4	457.80
54"	CBU185472S4	507.80
60"	CBU186072S4	542.60

LENGTH	CODE	LIST PRICE EA.
28¼"	CBA183072S4	\$ 285.30
34¼"	CBA183672S4	321.70
40¼"	CBA184272S4	371.30
46¼"	CBA184872S4	386.90
52¼"	CBA185472S4	436.90
58¼"	CBA186072S4	471.70

Starter

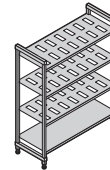

Add-On

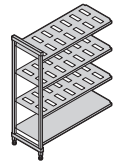

LENGTH	CODE	LIST PRICE EA.
30"	CBU183072VS4	\$ 349.60
36"	CBU183672VS4	384.05
42"	CBU184272VS4	431.40
48"	CBU184872VS4	447.75
54"	CBU185472VS4	494.90
60"	CBU186072VS4	527.15

LENGTH	CODE	LIST PRICE EA.
28¼"	CBA183072VS4	\$ 278.70
34¼"	CBA183672VS4	313.15
40¼"	CBA184272VS4	360.50
46¼"	CBA184872VS4	376.85
52¼"	CBA185472VS4	424.00
58¼"	CBA186072VS4	456.25

21"
DEPTH

30"	CBU213072S4	\$ 388.60
36"	CBU213672S4	430.60
42"	CBU214272S4	484.00
48"	CBU214872S4	509.80
54"	CBU215472S4	563.40
60"	CBU216072S4	600.40

28¼"	CBA213072S4	\$ 316.00
34¼"	CBA213672S4	358.00
40¼"	CBA214272S4	411.40
46¼"	CBA214872S4	437.20
52¼"	CBA215472S4	490.80
58¼"	CBA216072S4	527.80

30"	CBU213072VS4	\$ 379.30
36"	CBU213672VS4	419.50
42"	CBU214272VS4	472.30
48"	CBU214872VS4	493.60
54"	CBU215472VS4	546.75
60"	CBU216072VS4	582.85

28¼"	CBA213072VS4	\$ 306.70
34¼"	CBA213672VS4	346.90
40¼"	CBA214272VS4	399.70
46¼"	CBA214872VS4	421.00
52¼"	CBA215472VS4	474.15
58¼"	CBA216072VS4	510.25

24"
DEPTH

30"	CBU243072S4	\$ 406.50
36"	CBU243672S4	447.50
42"	CBU244272S4	495.10
48"	CBU244872S4	528.30
54"	CBU245472S4	576.30
60"	CBU246072S4	612.50

28¼"	CBA243072S4	\$ 333.25
34¼"	CBA243672S4	374.25
40¼"	CBA244272S4	421.85
46¼"	CBA244872S4	455.05
52¼"	CBA245472S4	503.05
58¼"	CBA246072S4	539.25

30"	CBU243072VS4	\$ 396.15
36"	CBU243672VS4	432.35
42"	CBU244272VS4	479.35
48"	CBU244872VS4	510.75
54"	CBU245472VS4	555.75
60"	CBU246072VS4	589.10

28¼"	CBA243072VS4	\$ 322.90
34¼"	CBA243672VS4	359.10
40¼"	CBA244272VS4	406.10
46¼"	CBA244872VS4	437.50
52¼"	CBA245472VS4	482.50
58¼"	CBA246072VS4	515.85

Color: Brushed Graphite (580).

V4

4-Shelf Vented Stationary Starter and Add-On Units

V5

5-Shelf Vented Stationary Starter and Add-On Units

Units ship complete in 1 box and include 1 or 2 factory assembled post kits, traverses, dovetails and shelf plates.

84"

HEIGHT

Starter

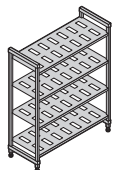

Add-On

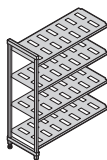

18"

DEPTH

LENGTH	CODE	LIST PRICE EA.
30"	CBU183084V4	\$ 369.60
36"	CBU183684V4	403.40
42"	CBU184284V4	450.00
48"	CBU184884V4	466.60
54"	CBU185484V4	512.80
60"	CBU186084V4	544.20

LENGTH	CODE	LIST PRICE EA.
28¼"	CBA183084V4	\$ 287.60
34¼"	CBA183684V4	321.40
40¼"	CBA184284V4	368.00
46¼"	CBA184884V4	384.60
52¼"	CBA185484V4	430.80
58¼"	CBA186084V4	462.20

Starter

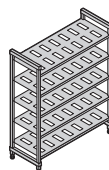

Add-On

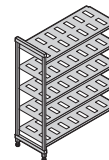

LENGTH	CODE	LIST PRICE EA.
30"	CBU183084V5	\$ 421.00
36"	CBU183684V5	463.25
42"	CBU184284V5	521.50
48"	CBU184884V5	542.25
54"	CBU185484V5	600.00
60"	CBU186084V5	639.25

LENGTH	CODE	LIST PRICE EA.
28¼"	CBA183084V5	\$ 339.00
34¼"	CBA183684V5	381.25
40¼"	CBA184284V5	439.50
46¼"	CBA184884V5	460.25
52¼"	CBA185484V5	518.00
58¼"	CBA186084V5	557.25

21"

DEPTH

30"	CBU213084V4	\$ 398.30
36"	CBU213684V4	437.90
42"	CBU214284V4	490.50
48"	CBU214884V4	510.30
54"	CBU215484V4	563.30
60"	CBU216084V4	599.10

28¼"	CBA213084V4	\$ 314.65
34¼"	CBA213684V4	354.25
40¼"	CBA214284V4	406.85
46¼"	CBA214884V4	426.65
52¼"	CBA215484V4	479.65
58¼"	CBA216084V4	515.45

30"	CBU213084V5	\$ 456.05
36"	CBU213684V5	505.55
42"	CBU214284V5	571.30
48"	CBU214884V5	596.05
54"	CBU215484V5	662.30
60"	CBU216084V5	707.05

28¼"	CBA213084V5	\$ 372.40
34¼"	CBA213684V5	421.90
40¼"	CBA214284V5	487.65
46¼"	CBA214884V5	512.40
52¼"	CBA215484V5	578.65
58¼"	CBA216084V5	623.40

24"

DEPTH

30"	CBU243084V4	\$ 414.70
36"	CBU243684V4	449.30
42"	CBU244284V4	496.10
48"	CBU244884V4	526.90
54"	CBU245484V4	570.90
60"	CBU246084V4	603.30

28¼"	CBA243084V4	\$ 330.45
34¼"	CBA243684V4	365.05
40¼"	CBA244284V4	411.85
46¼"	CBA244884V4	442.65
52¼"	CBA245484V4	486.65
58¼"	CBA246084V4	519.05

30"	CBU243084V5	\$ 476.25
36"	CBU243684V5	519.50
42"	CBU244284V5	578.00
48"	CBU244884V5	616.50
54"	CBU245484V5	671.50
60"	CBU246084V5	712.00

28¼"	CBA243084V5	\$ 392.00
34¼"	CBA243684V5	435.25
40¼"	CBA244284V5	493.75
46¼"	CBA244884V5	532.25
52¼"	CBA245484V5	587.25
58¼"	CBA246084V5	627.75

S4

4-Shelf Solid Stationary Starter and Add-On Units

S5

5-Shelf Solid Stationary Starter and Add-On Units

Units ship complete in 1 box and include 1 or 2 factory assembled post kits, traverses, dovetails and shelf plates.

84"
HEIGHT

Starter

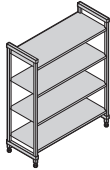

Add-On

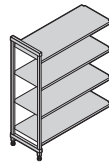

18"
DEPTH

LENGTH	CODE	LIST PRICE EA.
30"	CBU183084S4	\$ 378.40
36"	CBU183684S4	414.80
42"	CBU184284S4	464.40
48"	CBU184884S4	480.00
54"	CBU185484S4	530.00
60"	CBU186084S4	564.80

LENGTH	CODE	LIST PRICE EA.
28¼"	CBA183084S4	\$ 296.40
34¼"	CBA183684S4	332.80
40¼"	CBA184284S4	382.40
46¼"	CBA184884S4	398.00
52¼"	CBA185484S4	448.00
58¼"	CBA186084S4	482.80

Starter

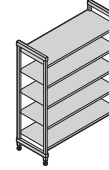

Add-On

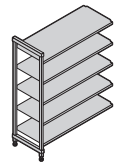

LENGTH	CODE	LIST PRICE EA.
30"	CBU183084S5	\$ 432.00
36"	CBU183684S5	477.50
42"	CBU184284S5	539.50
48"	CBU184884S5	559.00
54"	CBU185484S5	621.50
60"	CBU186084S5	665.00

LENGTH	CODE	LIST PRICE EA.
28¼"	CBA183084S5	\$ 350.00
34¼"	CBA183684S5	395.50
40¼"	CBA184284S5	457.50
46¼"	CBA184884S5	477.00
52¼"	CBA185484S5	539.50
58¼"	CBA186084S5	583.00

21"
DEPTH

30"	CBU213084S4	\$ 410.70
36"	CBU213684S4	452.70
42"	CBU214284S4	506.10
48"	CBU214884S4	531.90
54"	CBU215484S4	585.50
60"	CBU216084S4	622.50

28¼"	CBA213084S4	\$ 327.05
34¼"	CBA213684S4	369.05
40¼"	CBA214284S4	422.45
46¼"	CBA214884S4	448.25
52¼"	CBA215484S4	501.85
58¼"	CBA216084S4	538.85

30"	CBU213084S5	\$ 471.55
36"	CBU213684S5	524.05
42"	CBU214284S5	590.80
48"	CBU214884S5	623.05
54"	CBU215484S5	690.05
60"	CBU216084S5	736.30

28¼"	CBA213084S5	\$ 387.90
34¼"	CBA213684S5	440.40
40¼"	CBA214284S5	507.15
46¼"	CBA214884S5	539.40
52¼"	CBA215484S5	606.40
58¼"	CBA216084S5	652.65

24"
DEPTH

30"	CBU243084S4	\$ 428.50
36"	CBU243684S4	469.50
42"	CBU244284S4	517.10
48"	CBU244884S4	550.30
54"	CBU245484S4	598.30
60"	CBU246084S4	634.50

28¼"	CBA243084S4	\$ 344.25
34¼"	CBA243684S4	385.25
40¼"	CBA244284S4	432.85
46¼"	CBA244884S4	466.05
52¼"	CBA245484S4	514.05
58¼"	CBA246084S4	550.25

30"	CBU243084S5	\$ 493.50
36"	CBU243684S5	544.75
42"	CBU244284S5	604.25
48"	CBU244884S5	645.75
54"	CBU245484S5	705.75
60"	CBU246084S5	751.00

28¼"	CBA243084S5	\$ 409.25
34¼"	CBA243684S5	460.50
40¼"	CBA244284S5	520.00
46¼"	CBA244884S5	561.50
52¼"	CBA245484S5	621.50
58¼"	CBA246084S5	666.75

Color: Brushed Graphite (580).

VS4

4-Shelf Vented and Solid Stationary Starter and Add-On Units

(3 vented + 1 solid)

VS5

5-Shelf Vented and Solid Stationary Starter and Add-On Units

(4 vented + 1 solid)

Units ship complete in 1 box and include 1 or 2 factory assembled post kits, traverses, dovetails and shelf plates.

84"

HEIGHT

18"

DEPTH

Starter

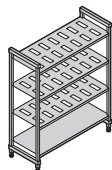

Add-On

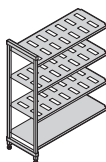

LENGTH	CODE	LIST PRICE EA.
30"	CBU183084VS4	\$ 371.80
36"	CBU183684VS4	406.25
42"	CBU184284VS4	453.60
48"	CBU184884VS4	469.95
54"	CBU185484VS4	517.10
60"	CBU186084VS4	549.35

LENGTH	CODE	LIST PRICE EA.
28¼"	CBA183084VS4	\$ 289.80
34¼"	CBA183684VS4	324.25
40¼"	CBA184284VS4	371.60
46¼"	CBA184884VS4	387.95
52¼"	CBA185484VS4	435.10
58¼"	CBA186084VS4	467.35

Starter

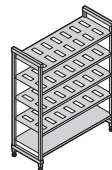

Add-On

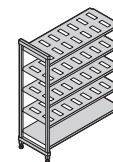

LENGTH	CODE	LIST PRICE EA.
30"	CBU183084VS5	\$ 423.20
36"	CBU183684VS5	466.10
42"	CBU184284VS5	525.10
48"	CBU184884VS5	545.60
54"	CBU185484VS5	604.30
60"	CBU186084VS5	644.40

LENGTH	CODE	LIST PRICE EA.
28¼"	CBA183084VS5	\$ 341.20
34¼"	CBA183684VS5	384.10
40¼"	CBA184284VS5	443.10
46¼"	CBA184884VS5	463.60
52¼"	CBA185484VS5	522.30
58¼"	CBA186084VS5	562.40

21"

DEPTH

30"	CBU213084VS4	\$ 401.40
36"	CBU213684VS4	441.60
42"	CBU214284VS4	494.40
48"	CBU214884VS4	515.70
54"	CBU215484VS4	568.85
60"	CBU216084VS4	604.95

28¼"	CBA213084VS4	\$ 317.75
34¼"	CBA213684VS4	357.95
40¼"	CBA214284VS4	410.75
46¼"	CBA214884VS4	432.05
52¼"	CBA215484VS4	485.20
58¼"	CBA216084VS4	521.30

30"	CBU213084VS5	\$ 459.15
36"	CBU213684VS5	509.25
42"	CBU214284VS5	575.20
48"	CBU214884VS5	601.45
54"	CBU215484VS5	667.85
60"	CBU216084VS5	712.90

28¼"	CBA213084VS5	\$ 375.50
34¼"	CBA213684VS5	425.60
40¼"	CBA214284VS5	491.55
46¼"	CBA214884VS5	517.80
52¼"	CBA215484VS5	584.20
58¼"	CBA216084VS5	629.25

24"

DEPTH

30"	CBU243084VS4	\$ 418.15
36"	CBU243684VS4	454.35
42"	CBU244284VS4	501.35
48"	CBU244884VS4	532.75
54"	CBU245484VS4	577.75
60"	CBU246084VS4	611.10

28¼"	CBA243084VS4	\$ 333.90
34¼"	CBA243684VS4	370.10
40¼"	CBA244284VS4	417.10
46¼"	CBA244884VS4	448.50
52¼"	CBA245484VS4	493.50
58¼"	CBA246084VS4	526.85

30"	CBU243084VS5	\$ 479.70
36"	CBU243684VS5	524.55
42"	CBU244284VS5	583.25
48"	CBU244884VS5	622.35
54"	CBU245484VS5	678.35
60"	CBU246084VS5	719.80

28¼"	CBA243084VS5	\$ 395.45
34¼"	CBA243684VS5	440.30
40¼"	CBA244284VS5	499.00
46¼"	CBA244884VS5	538.10
52¼"	CBA245484VS5	594.10
58¼"	CBA246084VS5	635.55



Stationary Post Kits

Ships **unassembled** in 1 box. Includes 2 stationary posts, post connectors and post connector wedges.



64"
HEIGHT

CODE	DIMENSIONS D x H	LIST PRICE EA.
CBPK1864	18" x 64"	\$ 69.35
CBPK2164	21" x 64"	71.10
CBPK2464	24" x 64"	71.70

72"
HEIGHT

CBPK1872	18" x 72"	\$ 70.90
CBPK2172	21" x 72"	72.60
CBPK2472	24" x 72"	73.25

84"
HEIGHT

CBPK1884	18" x 84"	\$ 82.00
CBPK2184	21" x 84"	83.65
CBPK2484	24" x 84"	84.25

Color: Brushed Graphite (580).

V1

Single Vented Shelf Kits

S1

Single Solid Shelf Kits

Includes 2 shelf traverses, traverse dovetails and vented or solid shelf plates. Ships in 1 box.

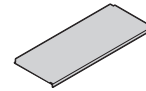
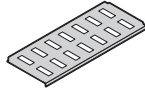

18"
DEPTH

CODE	DIMENSIONS D x L	LIST PRICE EA.
CBSK1830V1	18" x 30"	\$ 51.40
CBSK1836V1	18" x 36"	59.85
CBSK1842V1	18" x 42"	71.50
CBSK1848V1	18" x 48"	75.65
CBSK1854V1	18" x 54"	87.20
CBSK1860V1	18" x 60"	95.05

18"
DEPTH

CODE	DIMENSIONS D x L	LIST PRICE EA.
CBSK1830S1	18" x 30"	\$ 53.60
CBSK1836S1	18" x 36"	62.70
CBSK1842S1	18" x 42"	75.10
CBSK1848S1	18" x 48"	79.00
CBSK1854S1	18" x 54"	91.50
CBSK1860S1	18" x 60"	100.20

21"
DEPTH

CBSK2130V1	21" x 30"	\$ 57.75
CBSK2136V1	21" x 36"	67.65
CBSK2142V1	21" x 42"	80.80
CBSK2148V1	21" x 48"	85.75
CBSK2154V1	21" x 54"	99.00
CBSK2160V1	21" x 60"	107.95

21"
DEPTH

CBSK2130S1	21" x 30"	\$ 60.85
CBSK2136S1	21" x 36"	71.35
CBSK2142S1	21" x 42"	84.70
CBSK2148S1	21" x 48"	91.15
CBSK2154S1	21" x 54"	104.55
CBSK2160S1	21" x 60"	113.80

24"
DEPTH

CBSK2430V1	24" x 30"	\$ 61.55
CBSK2436V1	24" x 36"	70.20
CBSK2442V1	24" x 42"	81.90
CBSK2448V1	24" x 48"	89.60
CBSK2454V1	24" x 54"	100.60
CBSK2460V1	24" x 60"	108.70

24"
DEPTH

CBSK2430S1	24" x 30"	\$ 65.00
CBSK2436S1	24" x 36"	75.25
CBSK2442S1	24" x 42"	87.15
CBSK2448S1	24" x 48"	95.45
CBSK2454S1	24" x 54"	107.45
CBSK2460S1	24" x 60"	116.50

V4 4-Shelf Vented Kits

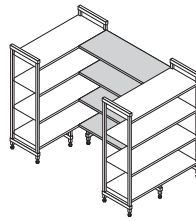

S4 4-Shelf Solid Kits

Includes 8 shelf traverses, traverse dovetails and vented or solid shelf plates.
Ships in 1 box. Install with 8 sets of corner connectors (CBCC8) to create a U-shape unit.

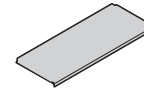
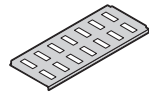

18"
DEPTH

CODE	DIMENSIONS D x L	LIST PRICE EA.
CBSK1836V4	18" x 36"	\$ 239.40
CBSK1842V4	18" x 42"	286.00
CBSK1848V4	18" x 48"	302.60

18"
DEPTH

CODE	DIMENSIONS D x L	LIST PRICE EA.
CBSK1836S4	18" x 36"	\$ 250.80
CBSK1842S4	18" x 42"	300.40
CBSK1848S4	18" x 48"	316.00

21"
DEPTH

CBSK2136V4	21" x 36"	\$ 270.60
CBSK2142V4	21" x 42"	323.20
CBSK2148V4	21" x 48"	343.00

21"
DEPTH

CBSK2136S4	21" x 36"	\$ 285.40
CBSK2142S4	21" x 42"	338.80
CBSK2148S4	21" x 48"	364.60

24"
DEPTH

CBSK2436V4	24" x 36"	\$ 280.80
CBSK2442V4	24" x 42"	327.60
CBSK2448V4	24" x 48"	358.40

24"
DEPTH

CBSK2436S4	24" x 36"	\$ 301.00
CBSK2442S4	24" x 42"	348.60
CBSK2448S4	24" x 48"	381.80

V5 5-Shelf Vented Kits

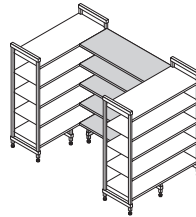

S5 5-Shelf Solid Kits

Includes 10 shelf traverses, traverse dovetails and vented or solid shelf plates.
Ships in 1 box. Install with 10 sets of corner connectors (CBCC10) to create a U-shape unit.

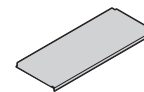
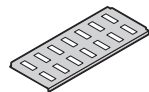

18"
DEPTH

CODE	DIMENSIONS D x L	LIST PRICE EA.
CBSK1836V5	18" x 36"	\$ 299.25
CBSK1842V5	18" x 42"	357.50
CBSK1848V5	18" x 48"	378.25

18"
DEPTH

CODE	DIMENSIONS D x L	LIST PRICE EA.
CBSK1836S5	18" x 36"	\$ 313.50
CBSK1842S5	18" x 42"	375.50
CBSK1848S5	18" x 48"	395.00

21"
DEPTH

CBSK2136V5	21" x 36"	\$ 338.25
CBSK2142V5	21" x 42"	404.00
CBSK2148V5	21" x 48"	428.75

21"
DEPTH

CBSK2136S5	21" x 36"	\$ 356.75
CBSK2142S5	21" x 42"	423.50
CBSK2148S5	21" x 48"	455.75

24"
DEPTH

CBSK2436V5	24" x 36"	\$ 351.00
CBSK2442V5	24" x 42"	409.50
CBSK2448V5	24" x 48"	448.00

24"
DEPTH

CBSK2436S5	24" x 36"	\$ 376.25
CBSK2442S5	24" x 42"	435.75
CBSK2448S5	24" x 48"	477.25

VS4 4-Shelf Kits

(3 Vented + 1 Solid)

Includes 8 shelf traverses, traverse dovetails and vented and solid shelf plates. Ships in 1 box. Install with 8 sets of corner connectors (CBCC8) to create a U-shape unit.

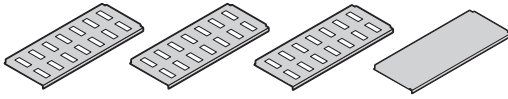

18"
DEPTH

CODE	DIMENSIONS D x L	LIST PRICE EA.
CBSK1836VS4	18" x 36"	\$ 242.25
CBSK1842VS4	18" x 42"	289.60
CBSK1848VS4	18" x 48"	305.95

21"
DEPTH

CBSK2136VS4	21" x 36"	\$ 274.30
CBSK2142VS4	21" x 42"	327.10
CBSK2148VS4	21" x 48"	348.40

24"
DEPTH

CBSK2436VS4	24" x 36"	\$ 285.85
CBSK2442VS4	24" x 42"	332.85
CBSK2448VS4	24" x 48"	364.25

VS5 5-Shelf Kits

(4 Vented + 1 Solid)

Includes 10 shelf traverses, traverse dovetails and vented and solid shelf plates. Ships in 1 box. Install with 10 sets of corner connectors (CBCC10) to create a U-shape unit.

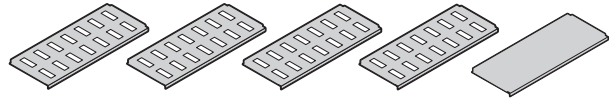

18"
DEPTH

CODE	DIMENSIONS D x L	LIST PRICE EA.
CBSK1836VS5	18" x 36"	\$ 302.10
CBSK1842VS5	18" x 42"	361.10
CBSK1848VS5	18" x 48"	381.60

21"
DEPTH

CBSK2136VS5	21" x 36"	\$ 341.95
CBSK2142VS5	21" x 42"	407.90
CBSK2148VS5	21" x 48"	434.15

24"
DEPTH

CBSK2436VS5	24" x 36"	\$ 356.05
CBSK2442VS5	24" x 42"	414.75
CBSK2448VS5	24" x 48"	453.85

Color: Brushed Graphite (580).



Corner Connectors

For use only with shelves 30" - 48" long. Unique patented design ensures maximum shelf space utilization. Use 1 set per shelf to connect starter and add-on units in corners. Connect 4 or 5 intermediate shelves between 2 starter units (2 sets required per shelf). Available as a single set or 8 or 10 set packs.

CODE	DESCRIPTION	LIST PRICE EA.
CBCC1	1 Set for 1 Shelf	\$ 5.65
CBCC8	8 Sets for 4 Shelves	45.20
CBCC10	10 Sets for 5 Shelves	56.50

Color: Brushed Graphite (580).

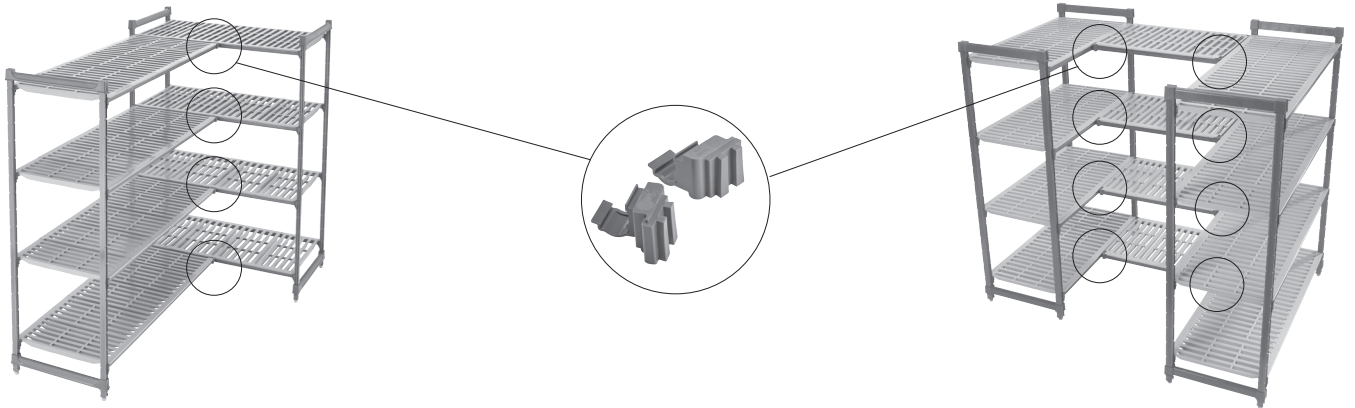

Bottom Shelf Dunnage Stands

Increase weight bearing capacity on bottom shelf only. Add to any shelf length. Highly recommended for starter units 54" and longer and all corner units, intermediate units and units specified for heavier load volume on and off bottom shelves.

CODE	DIMENSIONS D x H	LIST PRICE EA.
Dunnage Stand – Low (bottom shelf installed on lowest set of open post locations for dovetails)		
CBDS18H6	18" x 6¾"	\$ 51.75
CBDS21H6	21" x 6¾"	53.15
CBDS24H6	24" x 6¾"	54.40
Dunnage Stand – Tall (bottom shelf installed up on 2nd set of open post locations for dovetails)		
CBDS18H10	18" x 10¾"	51.95
CBDS21H10	21" x 10¾"	53.35
CBDS24H10	24" x 10¾"	54.60

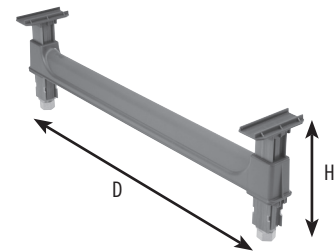
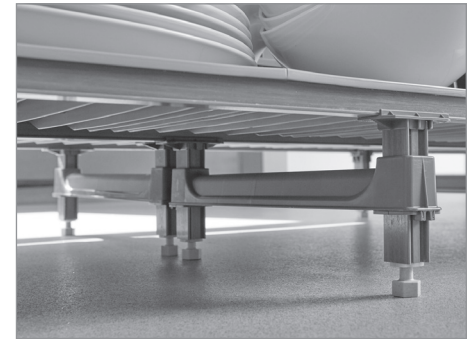

Bottom Shelf with Dunnage Stand

UNIT LENGTH	WEIGHT BEARING
Standard Unit	
30" - 48"	1,000 lbs.
54" - 60"	800
Corner Unit with 2 Dunnage Stands	
30" - 48"	450

Case Pack: 1 **Color:** Brushed Graphite (580).

Shelf Traverses

Add single stationary traverse on the back of a stationary unit for extra support when significant space is required between the bottom and second shelf shelf or when placing rolling equipment under the first shelf. Traverse dovetails included.

LENGTH	SINGLE PACK CODE*	LIST PRICE EA.	DOUBLE PACK CODE**	LIST PRICE EA.
30"	CBTR30	\$ 27.80	CBTR302PK	\$ 50.50
36"	CBTR36	28.00	CBTR362PK	50.90
42"	CBTR42	31.10	CBTR422PK	56.40
48"	CBTR48	34.00	CBTR482PK	61.80
54"	CBTR54	37.10	CBTR542PK	67.30
60"	CBTR60	39.90	CBTR602PK	72.50

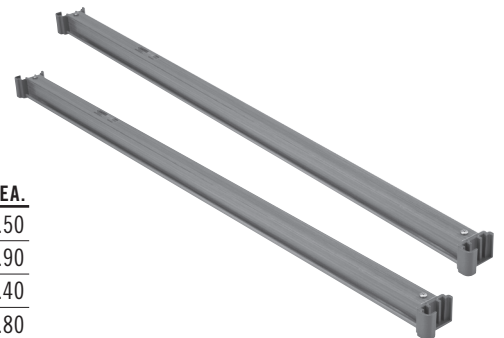

*Case Pack: 1 **Case Pack: 2 **Color:** Brushed Graphite (580).

CAMSHELVING® ACCESSORIES

Shelf Rail Kits

Use to prevent contents from falling off shelves. Protect individual sides or ends or wrap a full shelf. Rods are made from a strong composite material that is highly durable and will never rust or corrode. Fits shelving units 24" to 72" long and 14" to 24" deep. Full or three-quarter shelf kits help to streamline installations and significantly reduces carton waste.



	SHELF LENGTH	24"*	30"	36"	42"	48"	54"	60"	72"*
Full Shelf Rail Kits (Includes 2 sides and 2 ends in 1 box)									
14" DEPTH	PREMIUM	CPR1424	CPR1430	CPR1436	CPR1442	CPR1448	CPR1454	CPR1460	CPR1472
	ELEMENTS	ESR1424	ESR1430	ESR1436	ESR1442	ESR1448	ESR1454	ESR1460	ESR1472
	LIST PRICE EA.	\$ 103.95	\$ 109.80	\$ 115.90	\$ 124.00	\$ 130.10	\$ 138.10	\$ 144.10	\$ 158.30
18" DEPTH	PREMIUM	CPR1824	CPR1830	CPR1836	CPR1842	CPR1848	CPR1854	CPR1860	CPR1872
	ELEMENTS	ESR1824	ESR1830	ESR1836	ESR1842	ESR1848	ESR1854	ESR1860	ESR1872
	BASICS PLUS	—	CBR1830	CBR1836	CBR1842	CBR1848	CBR1854	CBR1860	—
	LIST PRICE EA.	\$ 107.55	\$ 113.40	\$ 119.50	\$ 127.60	\$ 133.70	\$ 141.75	\$ 147.70	\$ 161.90
21" DEPTH	PREMIUM	CPR2124	CPR2130	CPR2136	CPR2142	CPR2148	CPR2154	CPR2160	CPR2172
	ELEMENTS	ESR2124	ESR2130	ESR2136	ESR2142	ESR2148	ESR2154	ESR2160	ESR2172
	BASICS PLUS	—	CBR2130	CBR2136	CBR2142	CBR2148	CBR2154	CBR2160	—
	LIST PRICE EA.	\$ 110.20	\$ 116.10	\$ 122.15	\$ 130.30	\$ 136.35	\$ 144.40	\$ 150.40	\$ 164.60
24" DEPTH	PREMIUM	CPR2424	CPR2430	CPR2436	CPR2442	CPR2448	CPR2454	CPR2460	CPR2472
	ELEMENTS	ESR2424	ESR2430	ESR2436	ESR2442	ESR2448	ESR2454	ESR2460	ESR2472
	BASICS PLUS	—	CBR2430	CBR2436	CBR2442	CBR2448	CBR2454	CBR2460	—
	LIST PRICE EA.	\$ 113.10	\$ 118.95	\$ 125.05	\$ 133.20	\$ 139.25	\$ 147.30	\$ 153.25	\$ 167.50

Three-Quarter Shelf Rail Kits (Includes 1 side and 2 ends in 1 box)

14" DEPTH	PREMIUM	CPR14243	CPR14303	CPR14363	CPR14423	CPR14483	CPR14543	CPR14603	CPR14723
	ELEMENTS	ESR14243	ESR14303	ESR14363	ESR14423	ESR14483	ESR14543	ESR14603	ESR14723
	LIST PRICE EA.	\$ 74.35	\$ 77.30	\$ 80.35	\$ 84.40	\$ 87.45	\$ 91.45	\$ 94.45	\$ 101.55
18" DEPTH	PREMIUM	CPR18243	CPR18303	CPR18363	CPR18423	CPR18483	CPR18543	CPR18603	CPR18723
	ELEMENTS	ESR18243	ESR18303	ESR18363	ESR18423	ESR18483	ESR18543	ESR18603	ESR18723
	BASICS PLUS	—	CBR18303	CBR18363	CBR18423	CBR18483	CBR18543	CBR18603	—
	LIST PRICE EA.	\$ 77.95	\$ 80.90	\$ 83.95	\$ 88.00	\$ 91.05	\$ 95.05	\$ 98.05	\$ 105.15
21" DEPTH	PREMIUM	CPR21243	CPR21303	CPR21363	CPR21423	CPR21483	CPR21543	CPR21603	CPR21723
	ELEMENTS	ESR21243	ESR21303	ESR21363	ESR21423	ESR21483	ESR21543	ESR21603	ESR21723
	BASICS PLUS	—	CBR21303	CBR21363	CBR21423	CBR21483	CBR21543	CBR21603	—
	LIST PRICE EA.	\$ 80.65	\$ 83.60	\$ 86.60	\$ 90.70	\$ 93.75	\$ 97.75	\$ 100.75	\$ 107.85
24" DEPTH	PREMIUM	CPR24243	CPR24303	CPR24363	CPR24423	CPR24483	CPR24543	CPR24603	CPR24723
	ELEMENTS	ESR24243	ESR24303	ESR24363	ESR24423	ESR24483	ESR24543	ESR24603	ESR24723
	BASICS PLUS	—	CBR24303	CBR24363	CBR24423	CBR24483	CBR24543	CBR24603	—
	LIST PRICE EA.	\$ 83.55	\$ 86.45	\$ 89.50	\$ 93.60	\$ 96.60	\$ 100.65	\$ 103.60	\$ 110.75

Case Pack: 1 kit Color: Soft Gray (151). *Basics Plus Series not available in 14" depth or 24" or 72" length.

Single Side Rail Kits

PREMIUM	ELEMENTS	BASICS PLUS	LENGTH	LIST PRICE EA.
CPR24S	ESR24S	—	24"	\$ 29.55
CPR30S	ESR30S	CBR30S	30"	32.50
CPR36S	ESR36S	CBR36S	36"	35.55
CPR42S	ESR42S	CBR42S	42"	39.60
CPR48S	ESR48S	CBR48S	48"	42.65
CPR54S	ESR54S	CBR54S	54"	46.65
CPR60S	ESR60S	CBR60S	60"	49.65
CPR72S	ESR72S	—	72"	56.75

Case Pack: 1 Color: Soft Gray (151).

Single End Rail Kits

PREMIUM	ELEMENTS	BASICS PLUS	DEPTH	LIST PRICE EA.
CPR14E	ESR14E	—	14"	\$ 22.40
CPR18E	ESR18E	CBR18E	18"	24.20
CPR21E	ESR21E	CBR21E	21"	25.55
CPR24E	ESR24E	CBR24E	24"	27.00

Case Pack: 1 Color: Soft Gray (151).

CAMSHELVING® ACCESSORIES

Shelf Divider Bars

Create a custom service or storage station for food pans, boxes or dish racks. Install straight or angled dividers directly onto shelf traverses. Fits 24" deep shelf only.

CODE	DESCRIPTION	LIST PRICE EA.
Premium® Series		
CSDBA	Angled Divider Bar	\$ 5.95
CSDBS	Straight Divider Bar	5.95
Elements® Series		
EDBA	Angled Divider Bar	4.55
EDBS	Straight Divider Bar	4.55
Case Pack: 4 Color: Speckled Gray (480).		

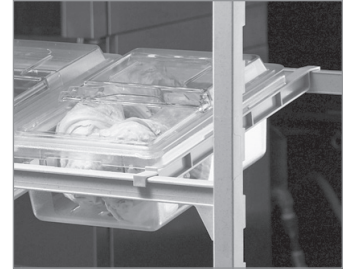
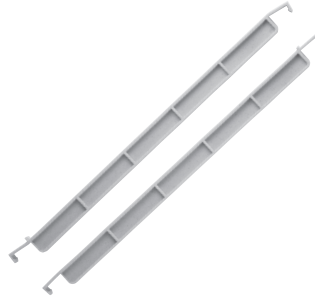

Shelf Divider Panel

Stack and separate items stored on shelves. Made of highly durable plastic. Installs directly onto solid or vented shelves. Easily removable for relocating or washing. Use with Shelf Rails to prevent contents from falling off shelves. Can be installed on shelves inside Full Wrap Security Cage units.

CODE	DIMENSION D x H	LIST PRICE EA.
Premium, Elements & Basics® Plus Series		
CSSD188	18" x 8"	\$ 17.50
CSSD218	21" x 8"	19.05
CSSD248	24" x 8"	20.60
Case Pack: 1 Color: Soft Gray (151).		

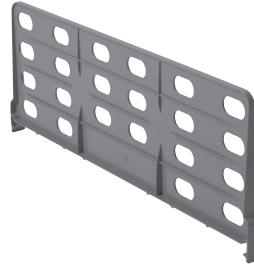

CAMSHELVING® ACCESSORIES

Wall Fastener

Use to secure stationary shelving unit to a wall for added safety and stability where required. Made of 300 series, 11 gauge stainless steel. Screws not included.

CODE	DIMENSION D x L x H	LIST PRICE EA.
Premium®, Elements® & Basics® Plus Series		
CSWF	2 7/8" x 9 3/8" x 1 1/8"	\$ 25.75
Case Pack: 4 Color: Silver (000).		



Hole diameter 7/16".

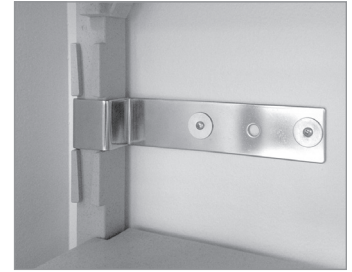

Floor Fasteners

Secure stationary unit posts directly to the floor for added safety and stability where required. Made of 300 series, 11 gauge stainless steel. Bolts not included.

CODE	DIMENSION D x L x H*	LIST PRICE EA.
Premium, Elements & Basics Plus Series		
CSFF	1 1/2" x 6 1/2" x 3 1/2"	\$ 34.00
Premium Series High Density		
CSHDF	1 3/8" x 4 1/4" x 1/2"	41.35

CSFF Case Pack: 2 CSHDF Case Pack: 4
Color: Silver (000).

*Height of CSFF includes stainless steel leveling foot.

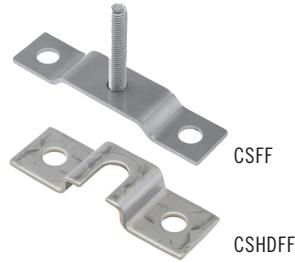

Hole diameter 9/16".

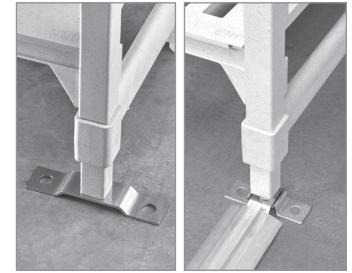

Ultimate Sheet Pan Rack for Single Shelf

Use to free up use of mobile speed racks and maximize storage in walk-in coolers, freezers, and/or work prep stations. Fits 24" or 21" deep vented or solid shelves. Holds up to 6 full size or 12 half size sheet pans. 40 lbs. per rail set, up to 200 lbs. per unit. Heat-tolerant rails accept sheet pans from oven up to 350°F. Secure racks to unit with 2 post clips, front and back for 24" or front only for 21" deep. Installation requires 5 open post dovetails between shelves. Lifetime warranty against rust and corrosion. Ships knockdown.

CODE	DIMENSION D x L x H	LIST PRICE EA.
Premium or Elements Series		
CSUPR1826S6	24 1/2" x 20 1/2" x 20 1/4"	\$ 180.00
Basics Plus Series		
CBUPR1826S6	24 1/2" x 20 1/2" x 20 1/4"	180.00
Case Pack: 1 Color: Brushed Graphite (580). Patent Applied For.		



CAMSHELVING® ACCESSORIES

Identification Tags

Clip onto shelf traverses to clearly identify stored product. Made of highly durable plastic with a clear slide in front panel. 14 labels included: 12 color-coded, pre-printed and 2 blank.

CODE	DESCRIPTION	DIMENSION L x H	LIST PRICE EA.
Premium® and Elements® Series			
CSID6	6" ID Tag	6" x 1"	\$ 2.30
CSID3	3" ID Tag	3" x 1"	2.30
Basics® Plus Series			
CBID6	6" ID Tag	6" x 1"	2.90

Case Pack: 12 **Color:** White / Clear.
Pre-printed, color labels, 2 each: Blue - Cooked Foods, Beige - Fish, Yellow - Poultry, White - Dairy, Green - Fruits and Vegetables, Red - Raw Meat.



Donut Bumpers

Offers added protection during transport and when maneuvering mobile units into place against walls or alongside other units for storage.

CODE	DIAMETER	LIST PRICE EA.
Premium Series		
CPMDB	3½"	\$ 9.60
Premium Series High Density*		
CSMHDDDB	5"	25.00
Elements Series		
CSMHDDDB	5"	25.00

Case Pack: 4 **Color:** Gray (000).

*All High Density Mobile Post Kits and Mobile Units include High Density Casters and Donut Bumpers.

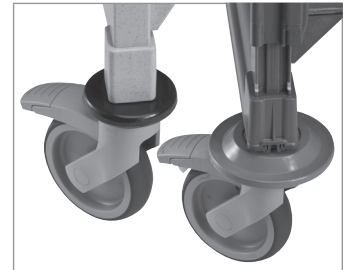
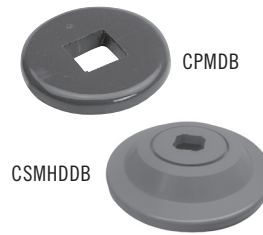

Security Cages

Store valuable products inside locked cage. Choose from single shelf or full wrap. Use in coolers, freezers and/or dry storage. Made of heavy duty, 304 stainless steel. Ships knockdown, lock not included.

Install Full-Wrap Cage on Premium Series 24" x 48" x 64" stationary unit or 24" x 48" x 67" mobile unit. Requires bottom vented shelf for installation. Maximum lock shackle diameter is 5/16".

Install Single Shelf Cage on 24" deep vented shelves only. Requires 18" or 4 open dovetails of space between shelves. Maximum lock shackle diameter is 0.295", between 1/4" and 5/16".

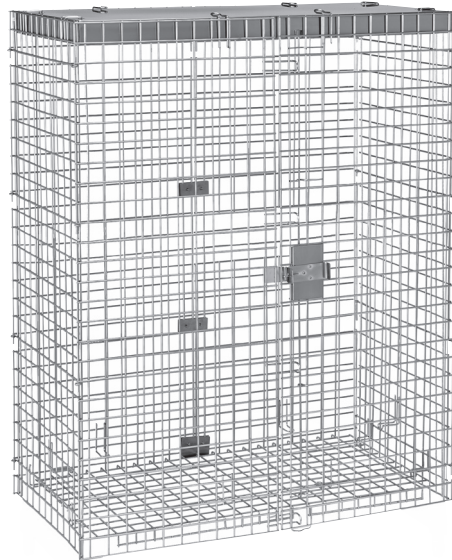

Full-Wrap Security Cage

CODE	DIMENSION D x L x H	LIST PRICE EA.
Premium Series		
CPFWSC244860	26¾" x 50¼" x 61½"	\$ 3,038.50

Case Pack: 1 **Color:** Silver (000).



Single Shelf Security Cage

CODE	DIMENSION D x L x H	LIST PRICE EA.
Premium, Elements & Basics Plus Series		
CSSC244818	25¼" x 42½" x 18"	\$ 659.20

Case Pack: 1 **Color:** Silver (000).

PREMIUM® SERIES FLEX STATIONS

- Ideal for take-out, delivery, curbside pick-up or classroom feeding.
- Use for bulk food/produce staging, kitchen utensil storage or for paper goods.
- Units ship knockdown complete in 1 box with factory assembled post kits.
- Modular components assemble quickly. Easy to reconfigure as needs change.
- Smooth, plastic surfaces wipe clean. All parts dishwasher safe.
- Anti-microbial shelf plates provide added safety insurance.
- Each unit includes 12 ID tags. Identify contents quickly and minimize handling.
- Premium swivel plastic casters all with total locking brake – locks swivel and wheel.

Flex Stations shown with Optional Merchandiser, Food Storage Pans and/or Boxes, Cam GoBoxes® and Cambro GoBags®. Available for purchase separately.



CPM244867FX1



CPM244867FX2



CPM244867FX3



CPM244875FX4

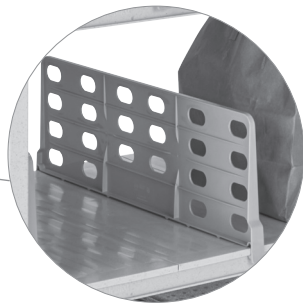

Stack and separate items stored on shelves with 8" high Shelf Divider Panels.



CPM244875FX5

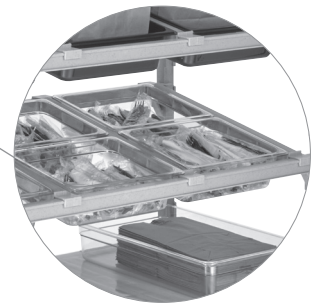

Create a custom station with a variety of food pans or food boxes and Shelf Divider Bars.

CODE	DESCRIPTION	DIMENSION D x L x H*	LIST PRICE EA.
CPM244867FX1	4 Tiers with 36 Angled Divider Bars	24" x 48" x 67"	\$ 1,068.90
CPM244867FX2	1 Solid Shelf, 3 Tiers with 30 Angled Divider Bars	24" x 48" x 67"	1,260.00
CPM244867FX3	4 Solid Shelves with 16 Divider Panels	24" x 48" x 67"	1,510.00
CPM244875FX4	4 Solid Shelves with 16 Divider Panels	24" x 48" x 75"	1,515.00
CPM244875FX5	2 Solid Shelves, 3 Tiers with 30 Angled Divider Bars	24" x 48" x 75"	1,475.00

Color: Speckled Gray (480). *Height includes 5" casters.

Units ship in

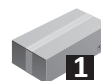

PREMIUM® SERIES FLEX STATIONS

Flex Station Merchandiser Kits

- Made of heavy duty, all weather, durable plastic.
- Contemporary, colorful graphics for enhanced visibility and sales appeal.
- Fresh and Fast Kit includes magnetic menu holder on 1 side panel.
- Fits 67" or 75" tall mobile units.

Note: To ensure clearance through doors, please note overall flex station unit height is either 75" or 83" with merchandiser header installed.



CSFLEXMERCH
Ideal for promoting educational nutrition programs.



CSFLEXMERCH2
Excellent for customer recognition of pickup & go delivery sites.

CODE	DESCRIPTION	DIMENSION	LIST PRICE EA.
Flex Station Merchandiser Kits			
CSFLEXMERCH	Fast & Fresh	W 23" x H 56" side W 48" x H 8" header	\$ 1,165.00
CSFLEXMERCH2	Pickup & Go	W 23" x H 56" side W 48" x H 8" header	1,165.00

Color: Multi (000).

Units ship in



MOBILE SHEET PAN/FOOD PAN RACKS

- Made from highly durable, composite plastic materials.
- Virtually unbreakable. 100% warranty against rust and corrosion.
- Low maintenance – no broken welds, dents or sharp edges.
- Easy to clean smooth, wipe down surfaces. Can also be pressure washed.
- Solid top and bottom connectors create a stable, solid frame for smooth handling.
- Sustainable for a lifetime of service with every part replaceable if needed.
- Unique top frame holds sheet pan or food pan(s) to protect contents below.
- Premium swivel plastic casters, all with total locking brake that locks swivel and wheel.
- Units ship knockdown, partially factory assembled, from box to service in minutes.



GN Food Pan Trolleys

- Can be used in coolers and freezers.
- Heat tolerant composite rails accepts hot pans from oven up to 392°F.
- Unique top frame holds GN 1/1 food pan(s) to protect contents below.
- Superior weight bearing per rail set and per unit.
- Place a GN 1/1 cutting board on half size 1/1 trolley for light duty food prep.
- Trolleys ship knockdown with caster and wedges factory assembled onto posts.



COMPONENT Patent Applied For.

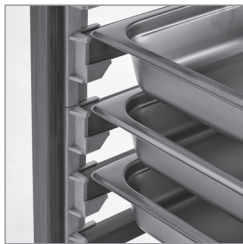

MOLDED IN PAN STOPS
0.12" pan stops at each rail end provide stability during transport.

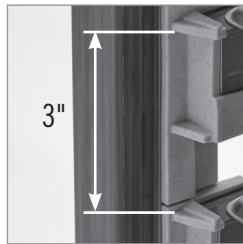

RAIL SPACING
Wide 3" rail spacing offers greatest versatility and ease of use.

GN 1/1 Food Pan Trolley Holding Capacity*

1 Full Size Pan per Rail Set, End Load

	2½"	4"	6"	8"
Full Size Trolley				
1/1 Pans	18	9	9	6
1/2 Pans	36	18	18	12
1/3 Pans	54	27	27	18
Half Size Trolley				
1/1 Pans	9	4	4	3
1/2 Pans	18	8	8	6
1/3 Pans	27	12	12	9

GN 2/1 Food Pan Trolley Holding Capacity*

2 Full Size Pans per Rail Set, Side Load

	2½"	4"	6"	8"
Full Size Trolley				
1/1 Pans	36	18	18	12
Half Size Trolley				
1/1 Pans	18	8	8	6

*Not including top frame position. Top frame holds 1 or 2 GN 1/1 full size food pans. Bottom rail set holds 2 1/2" deep pan(s) only.

MOBILE SHEET PAN/FOOD PAN RACKS

1/1 Food Pan Trolleys



CODE	UGNPR11H9	UGNPR11F18	GBCTUGNPR11
DESCRIPTION	Half Size Trolley	Full Size Trolley	Cover for Full Size Trolley
DIMENSION D x L x H*	28¾" x 17¼" x 40"	28¾" x 17¼" x 67½"	26" x 18¾" x 60½"
UNIT WEIGHT	32.68 lbs.	53.15 lbs.	—
LIST PRICE EACH	\$ 660.00	\$ 880.00	\$ 150.00

Food Pan Trolley Color: Speckled Gray (480). Cover Color: Opaque (000). *Includes 5" casters.
Weight capacity: 750 lbs. per full size unit, 375 lbs. per half size unit, 100 lbs. per rail set.

Units ship in  1

2/1 Food Pan Trolleys



CODE	UGNPR21H18	UGNPR21F36	GBCTUGNPR21
DESCRIPTION	Half Size Trolley	Full Size Trolley	Cover for Full Size Trolley
DIMENSION D x L x H*	32½" x 25½" x 40"	32½" x 25½" x 67½"	31" x 26¾" x 60½"
UNIT WEIGHT	37.7 lbs.	60.9 lbs.	—
LIST PRICE EACH	\$ 680.00	\$ 935.00	\$ 168.00

Food Pan Trolley Color: Speckled Gray (480). Cover Color: Opaque (000). *Includes 5" casters.
Weight capacity: 750 lbs. per full size unit, 375 lbs. per half size unit, 100 lbs. per rail set.

Units ship in  1

MOBILE SHEET PAN/FOOD PAN RACKS

Ultimate Sheet Pan Racks

- Holds full and half size sheet pans, 14 x 18 and 13 x 18 trays.
- Choose from 3" or 1 1/2" standard rail spacing.
- Use in coolers, freezers, blast chillers or proofing/retarding cabinets.
- Unique top frame holds full size sheet pan to protect contents below.
- Heat tolerant rails accept hot sheet pans from oven up to 350°F.
- Molded in rail ribs promote airflow for cooling and thawing.
- Positioning end ribs center sheet pans during light transport.

Ultimate Sheet Pan Rack is covered by U.S. Patent D853,0780 S and D841,273 S.



Full Size

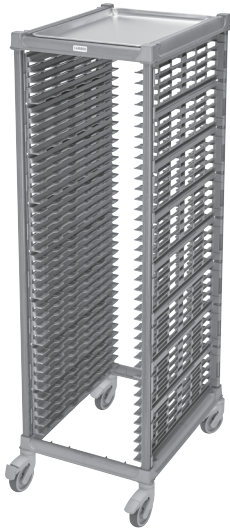

CODE	DIMENSIONS L x W x H*	RAIL SPACING	HOLDING CAPACITY	CASTER TYPE**	LIST PRICE EA.
Knockdown (KD) Units					
UPR1826FP20	33 ³ / ₈ " x 25 ¹ / ₁₆ " x 71 ⁵ / ₈ "	3"	20 Sheet pans/trays	Plastic	765.00
UPR1826FP40	33 ³ / ₈ " x 25 ¹ / ₁₆ " x 71 ⁵ / ₈ "	1 ¹ / ₂ "	40 Sheet pans/trays	Plastic	775.00
Factory Assembled (FA) Units					
UPR1826FPA20	33 ³ / ₈ " x 25 ¹ / ₁₆ " x 71 ⁵ / ₈ "	3"	20 Sheet pans/trays	Plastic	995.00
UPR1826FPA40	33 ³ / ₈ " x 25 ¹ / ₁₆ " x 71 ⁵ / ₈ "	1 ¹ / ₂ "	40 Sheet pans/trays	Plastic	1,055.00

Color: Brushed Graphite (580). *Dimensions include 5" plastic casters.
Weight capacity: 350 lbs. per rack, 55 lbs. per rail set.

Half Size



CODE	DIMENSIONS L x W x H*	RAIL SPACING	HOLDING CAPACITY	CASTER TYPE**	LIST PRICE EA.
UPR1826HP12	33 ³ / ₈ " x 25 ¹ / ₁₆ " x 47 ³ / ₄ "	3"	12 Sheet pans/trays	Plastic	560.00
UPR1826HP20	33 ³ / ₈ " x 25 ¹ / ₁₆ " x 47 ³ / ₄ "	1 ¹ / ₂ "	20 Sheet pans/trays	Plastic	615.00

Color: Brushed Graphite (580). *Dimensions include 5" plastic casters.
Weight capacity: 175 lbs. per rack, 55 lbs. per rail set.

**Full and Half Size Units also available with zinc plated metal casters. For more information about units with metal casters contact your Distributor, Cambro Sales Representative or the Cambro Customer Service Department.

Undercounter



CODE	DIMENSIONS L x W x H*	RAIL SPACING	HOLDING CAPACITY	LIST PRICE EA.
UPR1826U8	30 ⁷ / ₈ " x 23 ¹ / ₄ " x 33 ³ / ₈ "	3"	8 Sheet pans/trays	\$ 495.00
UPR1826U15	30 ⁷ / ₈ " x 23 ¹ / ₄ " x 31 ¹ / ₂ "	1 ¹ / ₂ "	15 Sheet pans/trays	540.00

Color: Brushed Graphite (580). *Dimensions include 3" metal casters.
Weight capacity: 90 lbs. per rack, 55 lbs. per rail set.

All units ship in



MOBILE SHEET PAN/FOOD PAN RACKS

Vinyl Cover

- Opaque, heavy duty vinyl with 2 front zippers.
- High heat tolerant. Cover/hold pans from oven up to 350°F.
- Clear 6" x 9" front window panel.

Insulated Cover

- Durable, insulated nylon with 2 front zippers.
- Helps keep food hot or cold for up to 1 hour.
- Clear front ID pocket.



CODE	GBCTUPR	GBIRC272162
DESCRIPTION	Vinyl Cover	Insulated Cover
DIMENSIONS L x W x H	32" x 24" x 66"	27½" x 21½" x 62"
COLOR	Opaque (CLR)	Black (110)
LIST PRICE EA.	\$ 170.00	\$ 585.00

Case Pack: 1



ULTIMATE #10 CAN RACK SYSTEM

- Front loading, gravity fed storage system.
- Optimizes safe handling and FIFO food rotation.
- Made from 100% highly durable, plastic.
- Lifetime warranty against rust and corrosion.
- Modular pieces snap together easily and quickly without tools.
- Low maintenance versus metal – no dents, bent or sharp edges.
- Ships knockdown. Units include 1 or 2 factory assembled post kits.
- Easy to clean. Dishwasher safe.

#10 Single and Add-on Can Racks are covered by U.S. Patent D828,145 S and D827,421 S.



Storage Capacity

	Per Row	Per Full Unit
#10 can	8 each	96 each
#5 can	12 each	144 each

Full Size Can Rack Unit

- High volume can storage in a compact footprint.
- Install on end(s) of High-Density Floor Track System.



Full Size Starter Unit

Full Size Add-on Can Rack Unit

- Maximize every inch of linear space in your kitchen or dry storage area with an in-line can rack.
- Connect Add-on Units to other units with shared posts.



Starter and Add-On Unit

PREMIUM® SERIES

CODE	CPU243672C96	CPA243672C96*
DESCRIPTION	Full Size Starter Unit	Full Size Add-on Unit (shared posts)
DIMENSION D x L x H	26" x 36" x 72"	26" x 34 1/4" x 72"
LIST PRICE EACH	\$ 980.00	\$ 830.00

ELEMENTS® SERIES

ESU243672C96	EA243672C96*
Full Size Starter Unit	Full Size Add-on Unit (shared posts)
26" x 36" x 72"	26" x 34" x 72"
\$ 865.00	\$ 755.00

Premium Series Color: Speckled Gray (480). Elements Series Color: Brushed Graphite (580). *Cannot be installed as corner units.

Units ship in

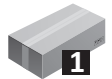

ULTIMATE #10 CAN RACK SYSTEM

Single and Add-on Can Racks

- Create single shelves of can storage on existing or new shelving units.
- Requires additional traverse per shelf length to complete installation.

NOTE: Cannot install on shelves on corner units or on intermediate shelves (shelves installed between 2 units using corner connectors).

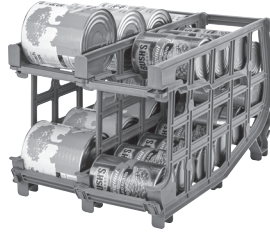

Partial Can Rack Storage

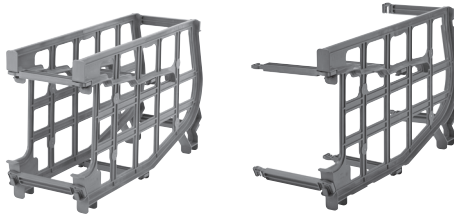

CODE	UCR10R8	UCR10AR8
DESCRIPTION	Single Can Rack, 2 panels and 6 brackets	Add-on Can Rack, 1 panel and 6 brackets
DIMENSION D x L x H	26" x 9¼" x 15½"	26" x 7¼" x 15½"
LIST PRICE EACH	\$ 110.00	\$ 65.00

Case Pack: 1 Color: Brushed Graphite (580).

Can Racks Per Shelf Length

SHELF LENGTH	NUMBER OF CAN RACKS PER TIER**	LEFTOVER SHELF SPACE	#10 CAN HOLDING CAPACITY
24"	2	3.5"	16
30"	3	2"	24
36"	4	0"	32
42"	4	6.5"	32
48"	5	5"	40
54"	6	3.5"	48
60"	7	2"	56

**1 Single Rack plus Add-on Racks.

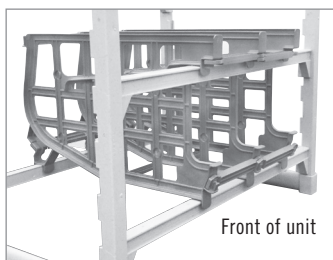

Front of unit

NOTE: Each tier of can racks requires 3 traverses, 2 front and 1 rear. Leave two open dovetails above top traverse before installing the next traverse/tier. This allows space to load cans. Can rack units cannot be specified to create corner units and individual racks cannot be installed on corner units.



PREMIUM® SERIES DRYING AND STORAGE RACKS

- Promotes sanitary air drying and minimizes handling.
- Efficient, high capacity storage in a compact footprint.
- Lifetime warranty against rust and corrosion.
- Cradles are made of highly durable ABS plastic.
- Will never bend or dent. Easy to clean and maintain.
- Racks ship knockdown with factory assembled post kits.
- Premium swivel plastic casters with total locking brake – locks both swivel and wheel.



Premium® Series Vertical Drying and Storage Racks

- For trays, sheet pans, lids and small cutting boards.
- Cradle slot is 1 5/16" wide. Dividers are 2 1/2" high.

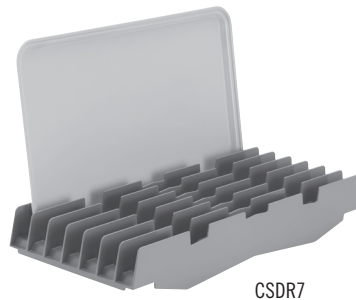

CSDR7



CODE	DIMENSIONS D x L x H*	HOLDING CAPACITY	CASE PACK	LIST PRICE EA.
Premium Series Vertical Drying and Storage Rack				
CPMU244875DRPKG	24" x 48" x 75"	84 Trays	1	\$ 1,454.15
CPMU246075DRPKG	24" x 60" x 75"	105 Trays	1	1,626.30
Vertical Drying and Storage Cradle for 24" deep shelf only (Fits all Camshelving® lines)				
CSDR7	23½" x 10¼" x 3¾"	—	1	57.70
CSDR73	23½" x 10¼" x 3¾"	—	3	173.10

Drying Rack Color: Speckled Gray (480). **Drying Cradle Color:** Soft Gray (151).

*Rack height includes 5" casters.

48" long unit ships in



60" long unit ships in

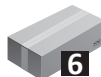

For building custom racks, use the Custom Drying Rack/Cradle Reference Guide on page 87.

PREMIUM® SERIES DRYING AND STORAGE RACKS

Premium Series Angled Drying and Storage Rack

- For meal delivery pellets, storage containers, food pans, pots and pans.
- Cradle slot is 2 3/8" wide.

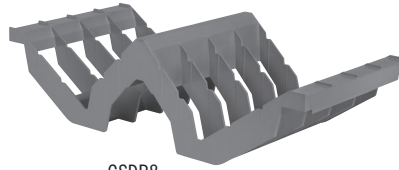

CSDR8



For building custom racks, use the Custom Drying Rack/Cradle Reference Guide on page 87.

CODE	DIMENSIONS D x L x H*	HOLDING CAPACITY	CASE PACK	LIST PRICE EA.
Premium Series Angled Drying and Storage Rack				
CPMU244875PDPKG	24" x 48" x 75"	128 Pellets and Bases or 16 GN 1/1 Food Pans	1	\$ 1,790.25
Angled Drying and Storage Cradle for 24" deep shelf only (Fits all Camshelving® lines)				
CSDR8	23 5/16" x 10 3/8" x 6 5/16"	—	1	46.35
CSDR84	23 5/16" x 10 3/8" x 6 5/16"	—	4	185.40

Drying Rack Color: Speckled Gray (480). **Drying Cradle Color:** Soft Gray (151).
*Rack height includes 5" casters.

Unit ships in



Premium Series Multi-Purpose Drying and Storage Racks

- For sheet pans, trays, cutting boards, food pans, storage containers, pots and pans and/or lids.
- Racks include vertical and angled drying cradles and may include 1 vented shelf plus shelf rails.

Holding Capacity Per Drying/Storage Tier

SHELF LENGTH	TRAYS	GN FULL SIZE FOOD PANS	PELLETS/BASES
36"	21	3	24
48"	28	4	32

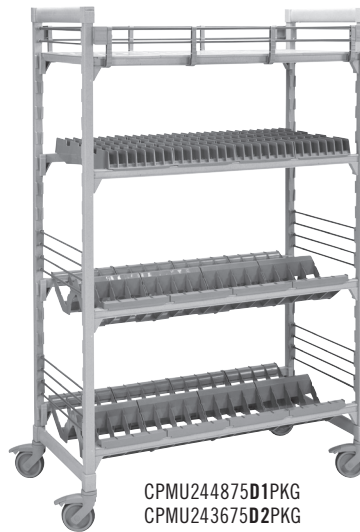

CPMU244875D1PKG
CPMU243675D2PKG



CPMU244875D3PKG
CPMU243675D4PKG

D1 and D2 Drying Racks Include 2 shelves of angled cradles, 1 shelf of vertical cradles, 1 vented shelf, 8 end rail kits and 1 full shelf rail kit.

D3 and D4 Drying Racks Include 2 shelves of angled cradles and 2 shelves of vertical cradles.

CODE	DIMENSIONS D x L x H*	CASE PACK	LIST PRICE EA.
CPMU244875D1PKG	24" x 48" x 75"	1	\$ 1,880.00
CPMU243675D2PKG	24" x 36" x 75"	1	1,646.15
CPMU244875D3PKG	24" x 48" x 75"	1	1,689.90
CPMU243675D4PKG	24" x 36" x 75"	1	1,298.40

Drying Rack Color: Speckled Gray (480). **Drying Cradle Shelf Rail Color:** Soft Gray (151).
*Height includes 5" casters.

D1 and D2 units ship in



D3 unit ships in



D4 unit ships in

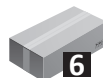

PREMIUM® SERIES DRYING AND STORAGE RACKS

Premium Series Dome Drying and Storage Rack

- For patient meal delivery domes.
- Cradle slot is 3 1/16" wide.



CSDDC24



For building custom racks, use the Custom Drying Rack/Cradle Reference Guide on page 87.

CODE	DIMENSIONS D x L x H*	HOLDING CAPACITY	CASE PACK	LIST PRICE EA.
Premium Series Dome Drying and Storage Rack				
CPMU243675DDPKG	24" x 36" x 75"	100 Domes	1	\$ 1,490.00
Dome Drying and Storage Cradle for 24" deep shelf only (Fits all Camshelving® lines)				
CSDDC24	24" x 16 1/2" x 3 3/8"	—	1	67.00
CSDDC245	24" x 16 1/2" x 3 3/8"	—	5	335.00

Drying Rack Color: Speckled Gray (480). **Drying Cradle Color:** Soft Gray (151).

*Rack height includes 5" casters.

Unit ships in



Premium Series Plate Cover Drying and Storage Rack

- For standard plate covers.
- Maximum plate cover dimensions
3" outside height,
10.8" inside diameter.

Fits Camwear Camcovers:

900CWNH, 1000CWNH, 1007CWNH,
1013CWNH.

Fits Versa Camcovers:

85SFVSNH 978SFVSNH, 86VSNH,
91VSNH, 913VSNH, 95VSNH, 99VSNH,
911VSNH, 100VSNH, 103VSNH,
105VSNH, 106VSNH, 110VSNH,
112VSNH.

CODE	DIMENSIONS D x L x H*	HOLDING CAPACITY	LIST PRICE EA.
CPMU243675D5PKG	24" x 36" x 75"	80 Covers	\$ 1,210.10

Shelving Color: Speckled Gray (480). **Drying Cradle Color:** Soft Gray (151).

*Height includes 5" casters.

Unit ships in



SECURITY AND UNDERCOUNTER UNITS

Premium® Series Full Wrap Security Cage Units

- Use to store valuable products behind locked doors.
- Can be used in freezers, coolers, kitchens or dry storage.
- Made of heavy-duty 304 stainless steel.
- Units include 2 vented shelves.
- Install Divider Panels directly onto shelves to organize product.
- Install additional vented or solid shelves without disassembling unit.
- Mobile unit includes premium swivel plastic casters, all with total locking brake. Locks swivel and motion.
- Maximum lock shackle diameter is 5/16". Lock not included.
- Ships knockdown (shelving unit and cage). Units ship in 1 box and include factory assembled post kits for quicker assembly. Cage ships with unit in a separate box.

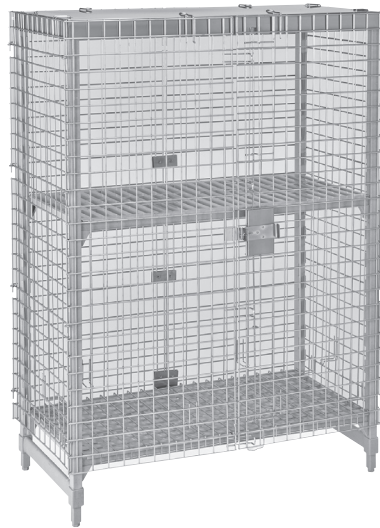

CODE	CPU244864SUPKG	CPMU244867SUPKG
DESCRIPTION	Full-wrap Stationary Security Unit	Full-wrap Mobile Security Unit
DIMENSION D x L x H	26¾" x 50¼" x 64½"	26¾" x 50¼" x 67¾"*
COLOR	Speckled Gray (480)	Speckled Gray (480)
LIST PRICE EA.	\$ 3,566.05	\$ 3,863.75

*Height includes 5" casters.

Units ship in  2

Elements® Series 2-Shelf Vented Undercounter Units

- Create storage in underutilized or hard-to-reach undercounter areas.
- Ideal for storing paper goods and non-perishable condiments.
- Choose from mobile or stationary units based on application/use.
- Mobile units include premium swivel plastic casters, all with total locking brake. Locks swivel and motion.
- Ships knockdown in 1 box with factory assembled post kits.



CODE	DIMENSIONS D x L x H*	LIST PRICE EA.
Stationary Units		
ESU183630V2	18" x 36" x 30"	\$ 298.40
ESU184830V2	18" x 48" x 30"	336.70
Mobile Units		
EMU142427V2	14" x 24" x 27"	513.60
EMU143627V2	14" x 36" x 27"	577.10
EMU144827V2	14" x 48" x 27"	616.50

Color: Brushed Graphite (580). *Height includes casters.

Units ship in  1

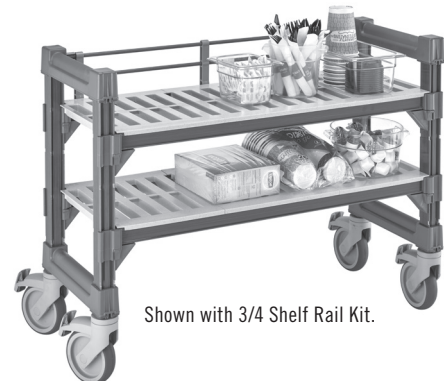

Shown with 3/4 Shelf Rail Kit.

WALL SHELVES AND SHELF EXTENDERS

Wall Shelves

Expand storage space in kitchens, above work stations and sinks. Features virtually indestructible I-beam supports that hold up to 150 lbs. per shelf. Durable polypropylene withstands temperatures up to 190°F, and will not rust or corrode. Snap fit rail design allows shelves to snap on and off for easy cleaning. Backsplash and marine front edge controls spills and cross contamination.

CODE	EXTERIOR DIM. L x W x H	LIST PRICE EA.
Solid Shelf		
CSWS1436SK	36" x 14" x 13½"	\$ 156.95
CSWS1448SK	48" x 14" x 13½"	180.25
CSWS1836SK	36" x 18" x 13½"	180.25
CSWS1848SK	48" x 18" x 13½"	197.65
Vented Shelf		
CSWS1436VK	36" x 14" x 13½"	156.95
CSWS1448VK	48" x 14" x 13½"	180.25
Shelf Extender		
CSWS36EK	35½" x 2" x 15½"	217.50
CSWS48EK	47½" x 2" x 15½"	323.55

Case Pack: 1 Wall Shelf Color: Speckled Gray (480).
Extender Peg Strip Color: Black (110).



Shelf Extenders ship in one carton with all hardware and includes:

LENGTH	PEG STRIPS	BRACKETS	HOOKS
36"	3	2	6
48"	3	3	9



Shelf Extenders

Convert empty wall space into a functional storage area. Use with or without Camshelving Wall Shelves. Peg strips withstand temperatures up to 190°F, and will not rust or corrode.

S-SERIES DUNNAGE RACKS

Keep frozen, cold or dry inventory 12" safely off the floor. One piece construction and sturdy legs provide strength and stability. Heavy duty polypropylene is safe to -36°F, and will not rust, corrode or bend. Choose slotted tops for maximum air circulation around perishable products stored in coolers or freezers. Solid tops catch spills for easy clean up. One Camlink included with each Dunnage Rack.



CODE	EXTERIOR DIMENSIONS H x D x W	LOAD CAPACITY	LIST PRICE EA.
Solid Top			
DRS30	12" x 21" x 30"	1,500 lbs.	\$ 242.05
DRS36	12" x 21" x 36"	1,500 lbs.	262.65
DRS48	12" x 21" x 48"	3,000 lbs.	314.15
DRS60	12" x 21" x 60"	3,000 lbs.	360.50
Slotted Top			
DRS300	12" x 21" x 30"	1,500 lbs.	242.05
DRS360	12" x 21" x 36"	1,500 lbs.	262.65
DRS480	12" x 21" x 48"	3,000 lbs.	314.15
DRS600	12" x 21" x 60"	3,000 lbs.	360.50
Camlink			
DRLNK	—	—	2.45

Dunnage Rack Case Pack: 1 Color: Speckled Gray (480), Dark Brown (131).

Camlink Case Pack: 6 Color: Black (110).

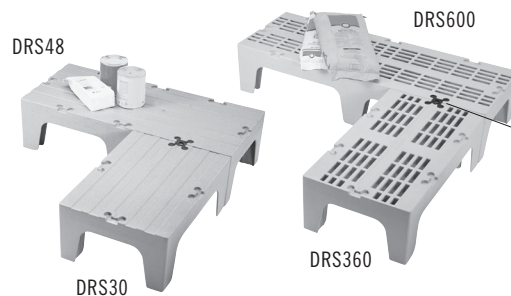

Camlink securely locks dunnage racks together for greater stability.

REPLACEMENT PARTS

Stationary Posts

CODE	DIMENSIONS	LIST PRICE EA.
Premium® Series		
CSP32	32"	\$ 24.20
CSP56	56"	40.10
CSP64	64"	44.75
CSP72	72"	46.10
CSP84	84"	55.20
Elements® Series		
EP30	30"	29.75
EP64	64"	35.30
EP72	72"	36.35
EP84	84"	43.55
Basics® Plus Series		
CBP64	64"	33.55
CBP72	72"	34.55
CBP84	84"	34.85

Mobile Posts

CODE	DIMENSIONS	LIST PRICE EA.
Premium Series		
CSPR35	35"	\$ 28.10
CSPR59	59"	42.25
CSPR67	67"	46.95
CSPR75	75"	48.45
Elements Series		
EMP27	27"	34.25
EMP70	70"	35.30
EMP78	78"	36.35

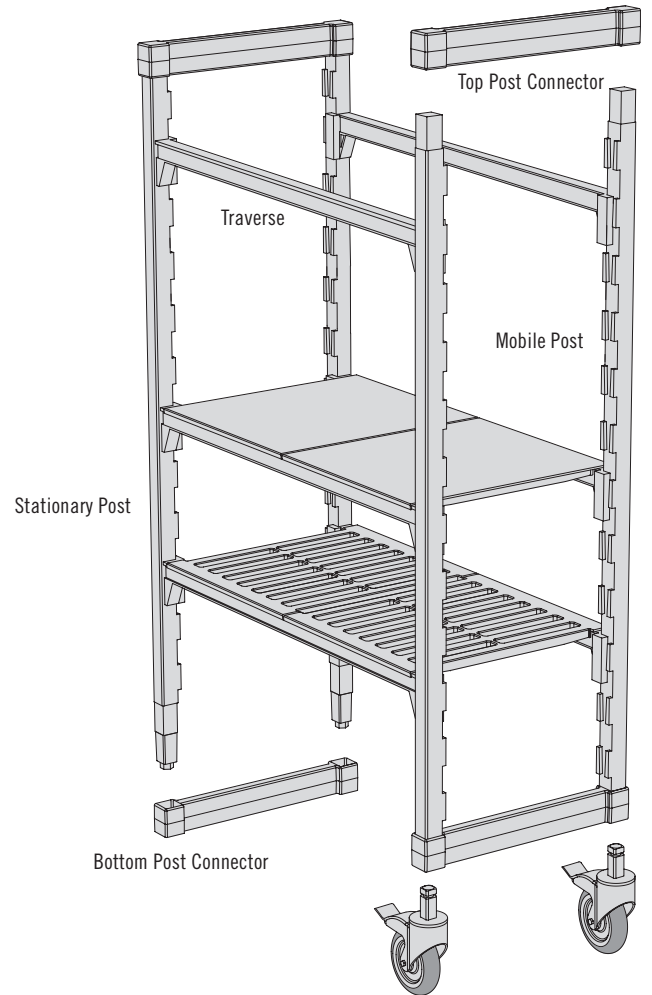

Traverses

LENGTH	SINGLE PACK CODE	LIST PRICE EA.	DOUBLE PACK CODE	LIST PRICE EA.
Premium Series				
24"	CPTR24	\$ 32.30	CPTR242PK	\$ 56.50
30"	CPTR30	34.90	CPTR302PK	61.20
36"	CPTR36	38.00	CPTR362PK	66.50
42"	CPTR42	40.60	CPTR422PK	72.50
48"	CPTR48	44.30	CPTR482PK	79.10
54"	CPTR54	48.10	CPTR542PK	85.80
60"	CPTR60	51.80	CPTR602PK	92.50
72"	CPTR72	56.50	—	—
Elements Series Stationary				
24"	ETR24	28.30	ETR242PK	53.90
30"	ETR30	30.60	ETR302PK	58.40
36"	ETR36	31.80	ETR362PK	60.70
42"	ETR42	34.00	ETR422PK	64.80
48"	ETR48	37.10	ETR482PK	70.70
54"	ETR54	40.20	ETR542PK	76.70
60"	ETR60	43.30	ETR602PK	82.70
72"	ETR72	49.50	—	—
Elements Series Mobile				
36"	EMTR36	43.50	EMTR362PK	69.00
42"	EMTR42	47.15	EMTR422PK	74.80
48"	EMTR48	50.75	EMTR482PK	80.50
54"	EMTR54	54.35	EMTR542PK	86.20
60"	EMTR60	58.00	EMTR602PK	92.00
Basics Plus Series				
30"	CBTR30	27.80	CBTR302PK	50.50
36"	CBTR36	28.00	CBTR362PK	50.90
42"	CBTR42	31.10	CBTR422PK	56.40
48"	CBTR48	34.00	CBTR482PK	61.80
54"	CBTR54	37.10	CBTR542PK	67.30
60"	CBTR60	39.90	CBTR602PK	72.50

Post Connectors

CODE	DESCRIPTION	LIST PRICE EA.
Premium Series		
CSPCT14	Top Post Connector 14"	\$ 10.25
CSPCB14	Bottom Post Connector 14"	10.25
CSPCT18	Top Post Connector 18"	12.75
CSPCB18	Bottom Post Connector 18"	12.75
CSPCT21	Top Post Connector 21"	14.30
CSPCB21	Bottom Post Connector 21"	14.30
CSPCT24	Top Post Connector 24"	14.95
CSPCB24	Bottom Post Connector 24"	14.95
Elements Series		
EPCT14	Top Post Connector 14"	9.60
EPCB14	Bottom Post Connector 14"	9.60
EPCT18	Top Post Connector 18"	11.60
EPCB18	Bottom Post Connector 18"	11.60
EPCT21	Top Post Connector 21"	12.70
EPCB21	Bottom Post Connector 21"	12.70
EPCT24	Top Post Connector 24"	13.40
EPCB24	Bottom Post Connector 24"	13.40
Basics Plus Series		
CBPCT18	Top Post Connector 18"	9.25
CBPCB18	Bottom Post Connector 18"	9.25
CBPCT21	Top Post Connector 21"	10.20
CBPCB21	Bottom Post Connector 21"	10.20
CBPCT24	Top Post Connector 24"	10.70
CBPCB24	Bottom Post Connector 24"	10.70

REPLACEMENT PARTS

Post Connector Collar Wedges

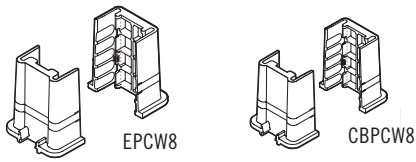

CODE	DESCRIPTION	LIST PRICE EA.
Elements® Series		
EPCW8	Bag of 8 Collar Wedges (4A and 4B)	\$ 6.40
Basics® Plus Series		
CBPCW8	Bag of 8 Collar Wedges (4A and 4B)	4.95

Corner Connectors

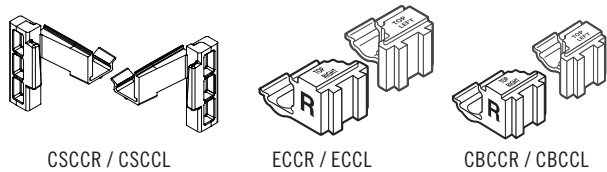

CODE	DESCRIPTION	LIST PRICE EA.
Premium® Series		
CSCCR	Right Corner Connector	\$ 3.75
CSCCL	Left Corner Connector	3.75
Elements Series		
ECCR	Right Corner Connector	3.00
ECCL	Left Corner Connector	3.00
Basics Plus Series		
CBCCR	Right Corner Connector	2.85
CBCCL	Left Corner Connector	2.85

Casters and Donut Bumpers

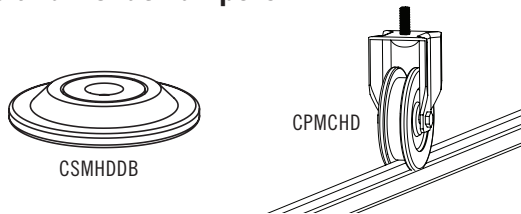

CODE	DESCRIPTION	LIST PRICE EA.
Premium Series		
CPMCWB	5" caster with total locking brake	\$ 72.15
CPMDB	Donut Bumper for CPMCWB	9.60
Premium Series High Density		
CPMCHD	5" grooved caster, no brake, includes bumper	55.55
CSMHDB	Donut Bumper only	25.00
Elements Series		
EMCWB	5" caster with total locking brake	58.35
CSMHDB	Donut Bumper for EMCWB	25.00

Traverse Dovetails

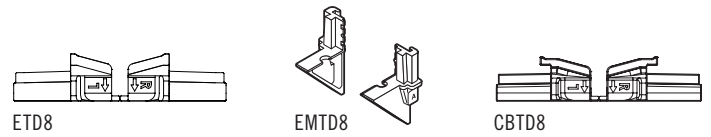

CODE	DESCRIPTION	LIST PRICE EA.
Elements Series — Stationary		
ETD8	Bag of 8 Dovetails, 4 each snap-apart, L and R	\$ 14.50
Elements Series — Mobile		
EMTD8	Bag of 8 Dovetails, 4 each, A and B	24.95
Basics Plus Series — Stationary Only		
CBTD8	Bag of 8 Dovetails, 4 each snap-apart, L and R	11.65

Post Leveling Foot

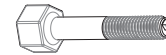

CODE	DESCRIPTION	LIST PRICE EA.
CSLF	Premium, Elements and Basics Plus Series	\$ 1.70

High Density Rails and Hardware

Track Joiner Kit H09010 includes:



Track Rail Joiner (x2)



Pan Head Screw (x8)



Star Washer (x8)

Track End Plate Kit H09011 includes:



Stainless Steel Leveling Foot (x8)

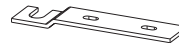

End Plate (x4)



Pan head Screw (x8)

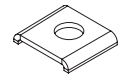

Plate Cap (x4)



Hex Nut (x4)



Star Washer (x8)

CODE	DESCRIPTION	LIST PRICE EA.
S09006	4.5' Rail Set	\$ 182.70
S09007	5' Rail Set	199.05
S09008	6' Rail Set	247.20
H09010	Track Rail Joiner Kit	58.20
H09011	Track End Plate Kit	182.70

REPLACEMENT PARTS

Wall Shelving

CODE	DESCRIPTION	LIST PRICE EA.
Premium® Series		
CSWS1836S	36" Wall Shelf Solid, 18" Width	\$ 96.05
CSWS1436S	36" Wall Shelf Solid, 14" Width	57.70
CSWS1436V	36" Wall Shelf Vented, 14" Width	55.90
CSWS1448S	48" Wall Shelf Solid, 14" Width	78.55
CSWS1448V	48" Wall Shelf Vented, 14" Width	69.00
CSWB14	14" Wall Shelf Bracket Kit	23.50
CSWB	18" Wall Shelf Bracket Kit	30.30
S06001	Peg Strip, 36" Long	49.95
S06002	Peg Strip, 48" Long	74.95
S06003	3-Peg Hooks	7.00
S06004	3-Peg Strip Screws	3.00
H06003	2-Lag Screws, 2-Washers	8.05
CSSE	Extender	13.20

Ultimate Sheet Pan Rack

CODE	DESCRIPTION	LIST PRICE EA.
Post Connector Frames and Wedges		
S19001	Bottom Post Connector Frame	\$ 110.00
S19002	Top Post Connector Frame	115.00
S19003	Wedges, Bag of 16	20.00
Rail Panel		
S19005	Rail Panel with 3" Spacing	55.00
S19006	Rail Panel with 1½" Spacing	52.00
Caster/Post Insert		
EMCWB	Caster Plastic 5" with Brake	58.35
S19007	Caster Zinc 5" with Brake	50.00
S19008	Caster Zinc 5" No Brake	50.00
S19009	Caster Zinc 3" with Brake for Undercounter Units only	37.00
S19010	Caster Zinc 3" No Brake for Undercounter Units only	37.00
S19004	Post Insert 4 Sets	15.00

Full Wrap Security Cage

CODE	DESCRIPTION	LIST PRICE EA.
S13010	Clamp Plates, Stainless Steel	\$ 5.25
S13011	Bolt Plate w/ Nuts, Stainless Steel	7.75
S13012	Bottom Plates, Stainless Steel	8.55
S13013	Hinge Bushing (16 each)	17.00
S13014	Nut, Stainless Steel 10-32	2.25

Padlock shackle maximum diameter is 5/16".

Single Shelf Security Cage

CODE	DESCRIPTION	LIST PRICE EA.
S07005	Security Hook	\$ 10.30

Padlock shackle maximum diameter is 1/4".

Ultimate #10 Can Rack

CODE	DESCRIPTION	LIST PRICE EA.
UCRCANRB6	Brackets, Bag of 6	\$ 8.80



SHELF PLATES AND DRYING RACK SHELF CONFIGURATIONS

Shelf Plates for Camshelving Premium® Series and Elements® Series

SHELF PLATE DIMENSIONS	SOLID SHELF PLATE CODE	LIST PRICE EA.	VENTED SHELF PLATE CODE	LIST PRICE EA.	PLATE POSITIONING
14" Deep					
14" x 6"	CS146S	\$ 15.45	CS146V	\$ 15.25	A
14" x 11"	CS1411S	17.50	CS1411V	16.55	B
14" x 12"	CS1412S	18.40	CS1412V	17.60	C
14" x 18"	CS1418S	23.90	CS1418V	22.00	D
18" Deep					
18" x 6"	CS186S	15.90	CS186V	15.40	A
18" x 11"	CS1811S	18.95	CS1811V	17.30	B
18" x 12"	CS1812S	19.40	CS1812V	18.30	C
18" x 18"	CS1818S	29.20	CS1818V	26.95	D
21" Deep					
21" x 6"	CS216S	19.55	CS216V	17.70	A
21" x 11"	CS2111S	23.10	CS2111V	21.55	B
21" x 12"	CS2112S	25.30	CS2112V	22.60	C
21" x 18"	CS2118S	36.50	CS2118V	33.40	D
24" Deep					
24" x 6"	CS246S	21.75	CS246V	20.90	A
24" x 11"	CS2411S	26.20	CS2411V	23.00	B
24" x 12"	CS2412S	28.55	CS2412V	27.05	C
24" x 18"	CS2418S	37.75	CS2418V	34.75	D

TRAVERSE LENGTH	PLATE CONFIGURATION FOR 14", 18", 21", 24" DEEP SHELVING				
24"	B	B			
30"	B	A	B		
36"	B	C	B		
42"	B	D	B		
48"	B	C	C	B	
54"	B	C	D	B	
60"	B	D	D	B	
72"	B	C	D	D	B

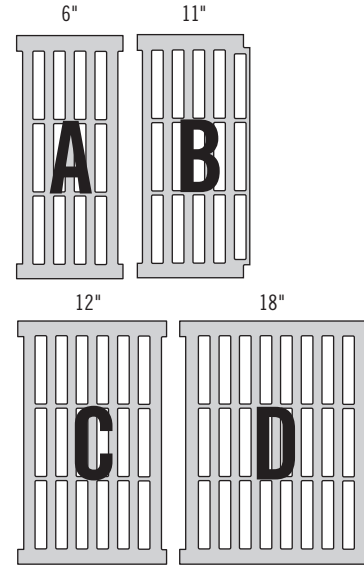

(18" available for Premium and Elements Series only.)

Shelf Plates for Camshelving Basics® Plus Series

SHELF PLATE DIMENSIONS	SOLID SHELF PLATE CODE	LIST PRICE EA.	VENTED SHELF PLATE CODE	LIST PRICE EA.	PLATE POSITIONING
18" Deep					
18" x 6"	CBSP186S	\$ 15.90	CBSP186V	\$ 12.30	A
18" x 11"	CBSP1811S	18.55	CBSP1811V	13.85	B
18" x 12"	CBSP1812S	19.65	CBSP1812V	14.65	C
21" Deep					
21" x 6"	CBSP216S	18.40	CBSP216V	14.15	A
21" x 11"	CBSP2111S	22.25	CBSP2111V	17.20	B
21" x 12"	CBSP2112S	23.80	CBSP2112V	18.10	C
24" Deep					
24" x 6"	CBSP246S	21.75	CBSP246V	16.80	A
24" x 11"	CBSP2411S	24.15	CBSP2411V	18.45	B
24" x 12"	CBSP2412S	27.85	CBSP2412V	21.65	C

TRAVERSE LENGTH	PLATE CONFIGURATION FOR 18", 21", 24" DEEP BASIC PLUS SHELVING				
30"	B	A	B		
36"	B	C	B		
42"	B	A	C	B	
48"	B	C	C	B	
54"	B	A	C	C	B
60"	B	C	C	C	B

Camshelving Premium Series Custom Drying Rack/Cradle Reference Guide

Unit Length	Maximum Number of Drying Cradles per Tier			Unused Space per Tier with maximum number of cradles installed			Number of Products per Tier		
	DOME CSDDC24	ANGLED CSDR8	VERTICAL CSDR7	DOME CSDDC24	ANGLED CSDR8	VERTICAL CSDR7	DOMES	BASES	TRAYS
24"	1	1	2	4.375"	10.25"	0"	10	8	14
30"	1	2	2	10.375"	6.25"	6.25"	10	16	14
36"	2	3	3	0"	2.62"	2.62"	20	24	21
42"	2	3	3	6"	8"	8"	20	24	21
48"	2	4	4	12"	3.75"	3.75"	20	32	28
54"*	3	4	4	1.75"	9.75"	9.75"	30	32	28
60"*	3	5	5	7.75"	5.5"	5.5"	30	40	35
72"*	4	6	6	3.375"	7.25"	7.25"	40	48	42

*Recommended for stationary units only

FREE CAMSHELVING® DESIGN SERVICE

Take the guesswork out of creating your perfect shelving layout. Let our expert shelving consultants prepare a free layout that optimizes your space to create the most storage options.

Here's what you'll get:

- 2D Floor Plan
- 3D Floor Plan
- Itemized product list by room/area
- All within 48 business-day hours

It's Simple! To Get Started, Please Provide:

- Project Name
- Storage Room Type (freezer / cooler)
- Room(s) Dimensions (L x W x H)
- Doorway / Entryway Location & Dimension
- Obstructions (condenser / pipes)
- Additional Preferences / Requirements

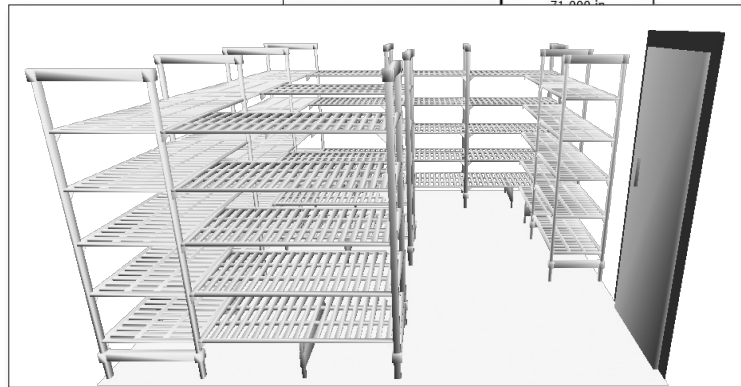
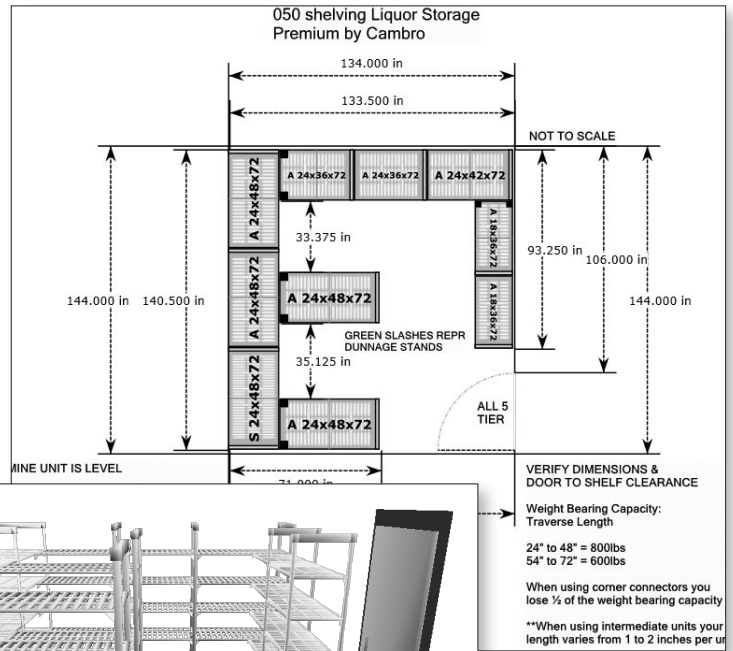

Request a Free 3D Shelving Layout

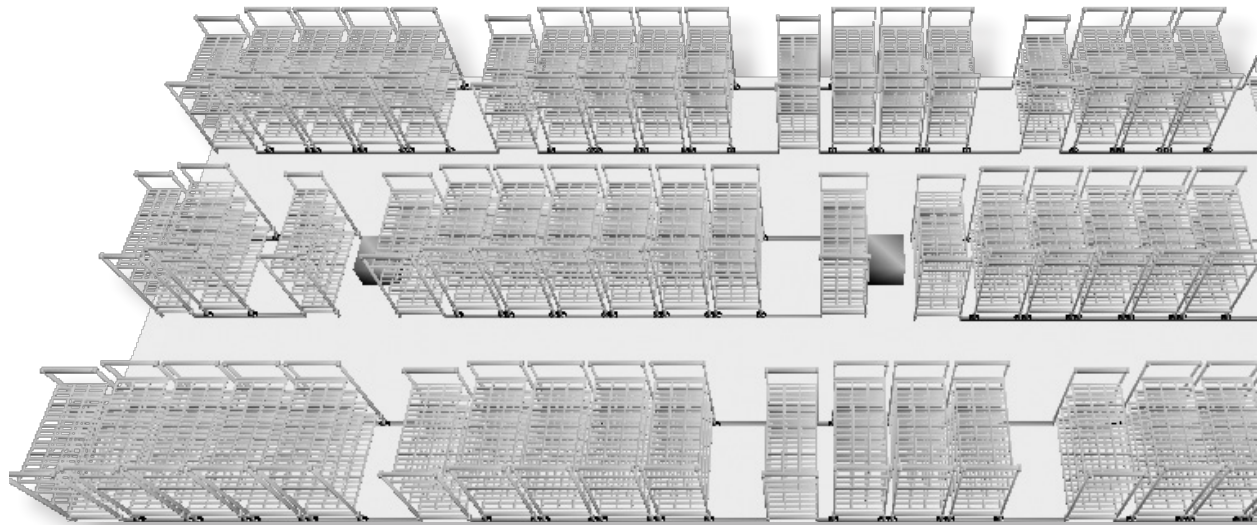

Email shelving@cambro.com or call TOLL FREE (877) 737-0663.



Telephone 714 848 1555 Toll Free 800 854 7631 Customer Service 800 833 3003
 © Cambro Manufacturing Company 5801 Skylab Road, Huntington Beach, California 92647-2056
 LIT2004 Prices subject to change without prior notification. Printed in U.S.A. 01/21

D032002