

Frosty Factory

of America, Inc.

2301 S. Farmerville St., Ruston, LA 71270

frostyfactory.com

(318) 255-1162 (800) 544-4071 (318) 255-1170 fax



Service Manual

All technical data, pictures and drawings contained in this manual are not binding on the manufacturer nor can the manufacturer be held liable for any modifications to the machine in whole or in part.

Revised 1/2016

TABLE OF CONTENTS

1.0 INTRODUCTION

- 1.1 Use of the Manual
- 1.2 Preliminary Inspection
- 1.3 Description
- 1.4 Dimensions

2.0 SAFETY AND INSTALLATION

- 2.1 Safety Precautions
- 2.2 Installation

3.0 OPERATION

- 3.1 Machine Controls
- 3.2 The Product You Serve
- 3.3 Product Consistency
- 3.4 Start Up
- 3.5 Freeze Time

4.0 MAINTENANCE

- 4.1 Cleaning
- 4.2 Re-Assembly
- 4.3 Preventative Maintenance
- 4.4 Extended Storage
- 4.5 Faceplate/Faucet Assembly
- 4.6 Float Switch
- 4.7 Thermostat Assembly
- 4.8 Using the Cleaning Brushes
- 4.9 Beater Bar Seal Installation
- 4.10 Scraper Blade and Spring Seal Installation
- 4.11 Ceramic Seal Removal and Re-installation

5.0 EQUIPMENT DRAWINGS

- 5.1 Drive Belt
- 5.2 Franklin Motor
- 5.3 Shim Placement
- 5.4 Rear Cylinder Assembly

6.0 TROUBLESHOOTING

7.0 SPARE PARTS LIST

8.0 WIRE DRAWINGS

9.0 WARRANTY

SECTION 1 INTRODUCTION

1.1 USE OF THIS MANUAL

Your service manual has been prepared as a guide to help you get the most from your Frozen Drink Machine. It contains information about the installation and operation of your machine. The manual also contains instructions for service and care. The manual should be read carefully by the operator of the Frozen Drink Machine to become familiar with the machine and the correct operating procedures described within. The following notations are used throughout the manual to bring important facts to your attention:

“Warning” - This notation is used whenever the personal safety of the operator(s) might be jeopardized, if procedures are not followed correctly.

WARNING
DO NOT INSERT ANY OBJECTS
INTO CYLINDER OR HOPPER WHILE
MACHINE IS RUNNING!

“Caution” - This notation is used whenever the machine or related equipment may receive or cause damage if not observed.

CAUTION
RISK OF ELECTRICAL SHOCK.
DISCONNECT POWER
BEFORE SERVICING UNIT.

CAUTION
MOVING PARTS
DO NOT OPERATE UNIT
WITH PANELS REMOVED

“Note” - This notation is used to bring important information to your attention that will enhance the performance of your machine.

1.2 PRELIMINARY INSPECTION

Unpack the unit as soon as possible upon its arrival. Check the entire machine and its contents for possible shipping damage. **Note damage on truck lines and notify your carrier immediately.** All machines are shipped FOB Ruston, Louisiana, which means that the machines left our docks in perfect working order. **Frosty Factory of America is not responsible for damaged merchandise once the equipment leaves our dock.** Inventory the accessories to be sure they include the items you specified on your order. Normally the accessories include:



Beater Bar, Drip Tray, Faceplate,
Faceplate Knobs, Hopper Cover,
Petro-Gel, Sanitizer, Spare Faucet O-Rings,
Warranty Card, Wire Brushes, Manual.

1.3 DESCRIPTION

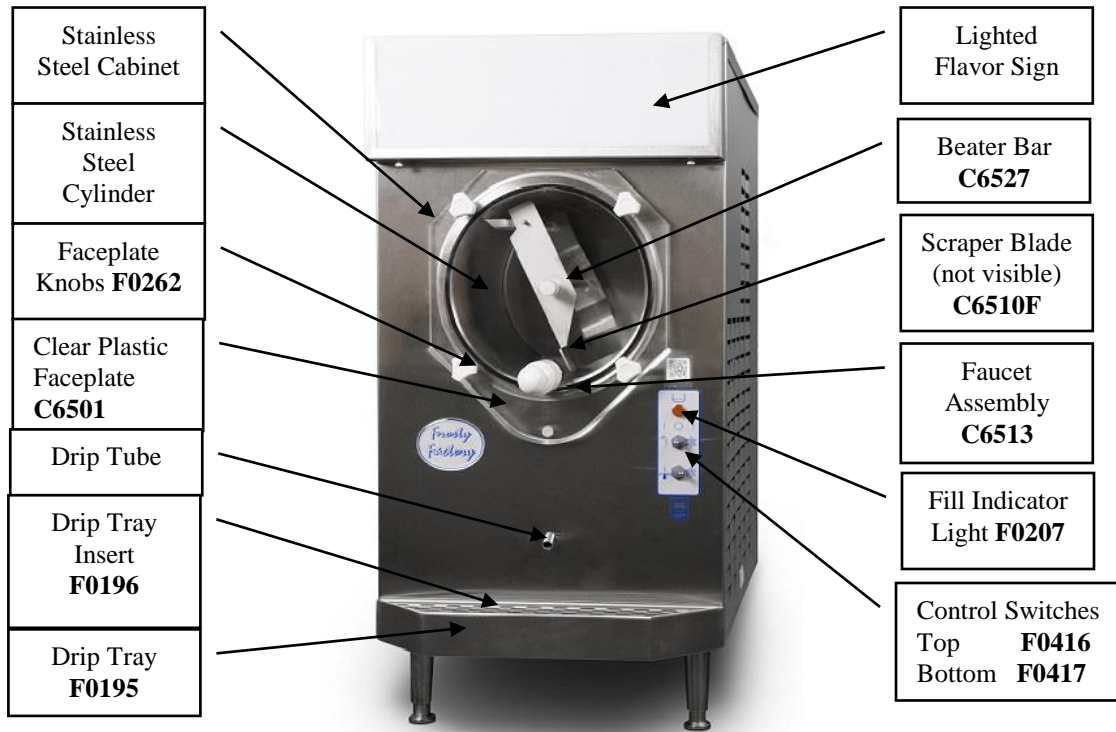

1.4 DIMENSIONS

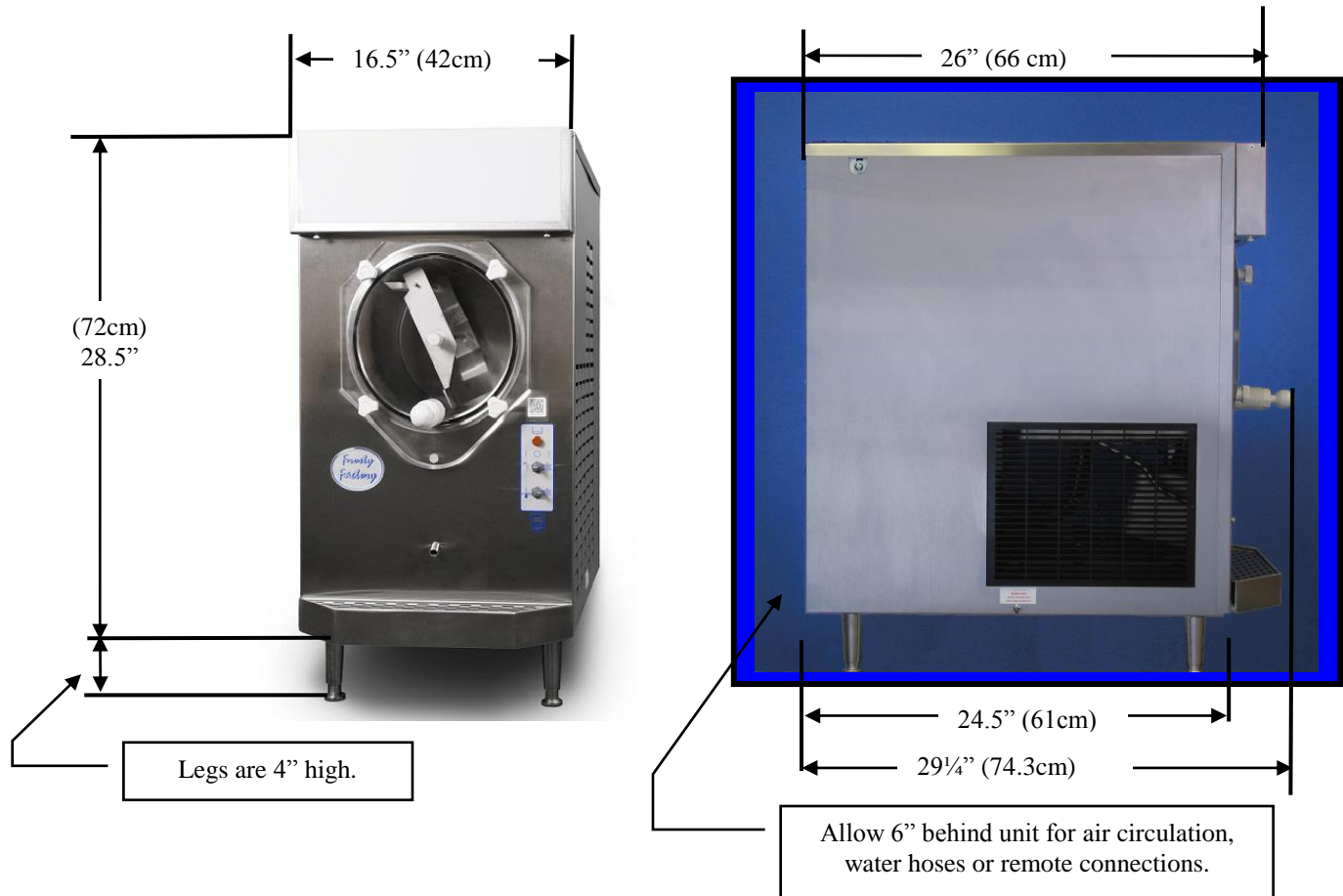

SECTION 2 LOCATION & INSTALLATION

2.1 SAFETY PRECAUTIONS

Do not attempt to operate your Frozen Drink Machine until the safety precautions and operating instructions in this manual are read completely and are thoroughly understood.

Take notice of all warning labels on your Frozen Drink Machine. The labels have been put there to inform and protect persons operating or servicing your equipment. Care must be taken not to damage or destroy labels during installation and servicing. The labels have been designed to withstand routine cleaning and handling. Damaged or missing labels should be promptly replaced with approved labels from Frosty Factory of America Inc.

2.2 INSTALLATION

Placing your Frozen Drink Machine in a highly visible area will enhance sales. A suitable station will be able to support 250 pounds and will have a dedicated electrical outlet.

CAUTION: Do not attempt to share the dedicated electrical outlet with any other appliance; this will cause the circuit breaker to trip.

1. Uncrate your Frozen Drink Machine.
2. The Frozen Drink Machine must be placed on a sturdy platform able to hold the weight of the machine when full of product. Level the machine by turning the adjustable part of the leg. The machine must be level front to back as well as left to right.
3. Frozen Drink Machines equipped with air cooled condensers must have **correct ventilation**. Air intake is at the rear of the Frozen Drink Machine and discharge through the side; both require 24" clearance and 8" at the back. All Frozen Drink Machines require 12" clearance at the top.

NOTE: Locating the unit in direct sunlight, near cooking facilities or any high heat area will reduce the performance of your machine.

CAUTION: Extended operations under severe heat condition can damage the cooling system.

NOTE: Establishments that serve beverages from frozen drink machines are responsible for providing the necessary facilities for cleaning and sanitizing their food service equipment.

4. Place the three-position switch in the OFF position (center).
5. Connect the power cord. The Frozen Drink Machine must be connected to a properly grounded receptacle. The electrical cord furnished as part of the Frozen Drink Machine has a three or four prong grounding type plug. The use of an extension cord is not recommended. If one must be used, consult the national and local electrical codes. **Do not** use an adapter to get around grounding requirements.

WARNING: Do not attempt to alter the electrical plug. Serious injury or electrocution may result.

Notice:
Your receptacle should look like one of these and match your unit voltage, amps on the data plate.

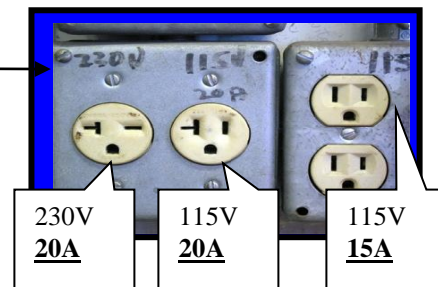

6. Install the drip tray, cover, beater bar and faceplate assemblies on the Frozen Drink Machine.

SECTION 3 OPERATION

3.1 MACHINE CONTROLS

Two selector switches located on the front of the machine control operation of the Frozen Drink Machine. Selection of the right (snowflake) position, with both switches, will schedule the machine for normal operation. The compressor cycle is protected by a time delay circuit, which will engage the compressor approximately 2 minutes after normal operation is initiated. A red fill light located above the switches will illuminate when the level of mix is low in the hopper. A thermostat knob on the electrical control box of your machine is set at the factory and should not be changed or adjusted except by an authorized service repairman.

Refer to the information below for functions available with various combinations of switch positions.



Normal Operation – Both switches on **snowflake**. Machine will freeze mix to provide frozen beverage as desired.

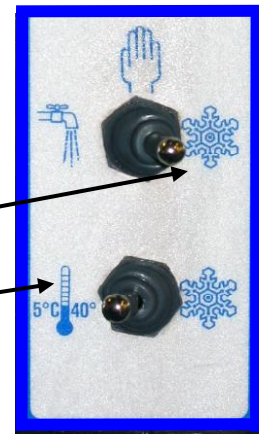

Cooling Operation – Top switch on **snowflake**, Bottom switch on **thermometer** symbol. Machine will automatically come on whenever necessary to keep mix cooled to 5°C/40°F - used primarily for overnight storage of mix remaining in the machine.



Cleaning Operation - The drive motor will run in the **faucet** position to allow a stirring action of the rinse water while cleaning.



Off - The hand symbol is the recognized international symbol for "stop". In this position, the machine will not run.

3.2 THE PRODUCT YOU SERVE

The Frozen Drink Machine will produce a fine grain, semi-frozen slush when the proper mix is used. When measured with a refractometer, the proper mix will measure 13 to 18 “brix”. Too little sugar in the mix will cause larger ice crystals to form. Too much sugar will lengthen the freeze time.

CAUTION: Any attempt to freeze water only will cause severe damage to your machine.

NOTE: Do not add sugar directly into the machine, as some of it will settle and result in an improper mix.

FRUIT JUICES with at least **32 grams of sugar per 8-oz. serving** will freeze well in the Frozen Drink Machine. They will remain stable during the freezing process while retaining their natural color and flavor.

NEUTRAL BASES are used to produce a neutral frozen cocktail base. A wide variety of different drinks can be created from one neutral base by the addition of various flavors. Most brands of neutral bases specify a mixture of four parts water to one part neutral base. However, before use in the Frozen Drink Machine, be sure the “brix” level is 13 to 18.

The amount of **ALCOHOL** in the recipe will affect the freezing process. As a rule of thumb, for the mix to freeze properly, the recipe should contain no more than 25 percent alcohol.

Suggestion for optimum production and sales:

- 1) Use the finest ingredients available.
- 2) Test the product before serving it.
- 3) Keep the machine clean - **ALWAYS!**

3.3 PRODUCT CONSISTENCY

An exclusive torque sensing mechanism developed by Frosty Factory of America will produce consistent texture and thickness of your frozen beverages. The adjustment screw (accessible through the left side panel as you face the machine front) is pre-set at the factory. Various mix consistencies can be achieved by turning the screw **clockwise (thicker drink) or counter clockwise (thinner drink)**. Turn the screw one full turn then allow enough time to lapse (about three minutes) for the compressor to complete a cycle before sampling. Continue this process until desired result is obtained.

TCC screw is visible through opening at rear of cabinet (as shown). Use a straight slot screwdriver to adjust. Clockwise thickens beverage, counterclockwise makes beverage thinner.



3.4 START UP

NOTICE: Before start-up, be sure the machine has been sanitized in accordance with procedures set forth in the cleaning section of this manual.

Pour the mix into the hopper and allow it to drain into the cylinder.



When the cylinder is full and the hopper is filled to one inch from the top, the machine is ready to run. Turn on by selecting the “right” (snowflake) position of **both** switches on the front panel.

NOTICE: Always add mix as soon as the orange, level indicator light, above the switches, comes on to prevent air from entering the cylinder.

CAUTION: Allowing air into the cylinder will cause a rocking motion of the machine. If the mix is not yet frozen the air can escape by turning the machine off for 20-30 seconds.

WARNING: Never under any circumstances, place your finger or any other object into the hopper or feed hole while the machine is in operation. Serious personal injury may occur.



3.5 FREEZE TIMES

The freeze time on the Frozen Drink Machine Model 137A is approximately **30** minutes when **ideal conditions** are met. Such as, starting mix temperature of 40 degrees and room temperature at 80 degrees. The time will increase with warm mix or if the machine is not properly ventilated or is operated in a hot environment. Recipes with high alcohol or high sugar content will naturally take a little longer.

SECTION 4 MAINTENANCE

4.1 CLEANING

The following cleaning procedure should be used for initial start-up and on an as needed basis to comply with the minimum cleaning and sanitizing frequencies specified by the Federal, state or local regulatory agency having jurisdiction.

- (1) Turn the machine to the off, “hand” position then remove hopper cover.
- (2) If applicable, drain mix into a sanitized container as per local health code procedures.

NOTE: Do not put hands or foreign matter into mix.

- (3) Pour two gallons of cool water (75°F) into the hopper. Place upper switch in “faucet” position to let the machine stir for 2 minutes. Turn machine “OFF”, drain and dispose of the rinse water. Repeat until water is clear.
- (4) **Remove the knobs from the faceplate** by turning in a counter clockwise direction. Carefully pull the faceplate straight away from the front of the machine. Remove the beater bar assembly from the cylinder. Then slide the spring seal off the rear of the beater bar. Unscrew white faucet cap to remove faucet plunger from faucet body. Remove all o-rings for cleaning.

NOTE: Do not unscrew faucet body from faceplate to clean. (Leak free service after disturbing the Teflon seal cannot be assured).

- (5) All parts removed during the above steps plus the drip tray and insert can now be cleaned in your warm (100° F) cleaning solution. Rinse all parts in clean rinse water and allow to air-dry before re-assembly.
- (6) Use cloth and cleaning solution to wipe any residue from cylinder and hopper.
- (7) Re-assemble as shown in section 4.2 (next page).
- (8) Mix two gallons of warm water (approximately 100° F with two ounces of sanitizing powder to achieve 100 parts/million (PPM) sanitizing solution.
- (9) Pour the sanitizing solution into the hopper.
- (10) Place upper switch in “faucet” position. Let solution stir for 5 minutes. Turn upper switch “OFF” (hand) position. **Drain all solution.**

Notice: Do not leave the solution in the machine for more than 5 minutes.

- (11) Pour product into hopper. Replace hopper cover. Place both switches in right (snowflake) position when ready to freeze product.



4.2 RE-ASSEMBLY

Using Petro-Gel, (**F0298**) lightly lubricate the longer end of the beater shaft.



Slide beater seal (**F0355**) onto the shaft with the spring end toward the beater bar.

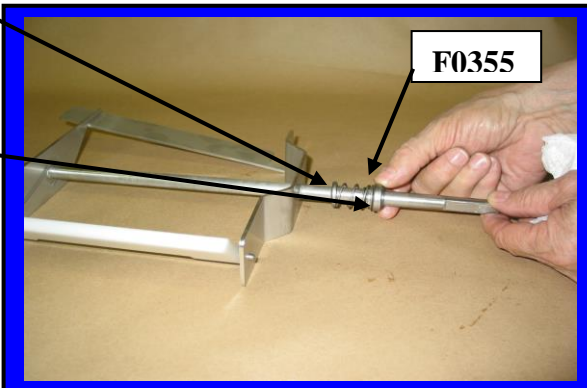

The **black carbon ring** must be facing the end of the beater bar so it will be in direct contact with the white ceramic seal inside the cylinder when the beater bar is re-installed.

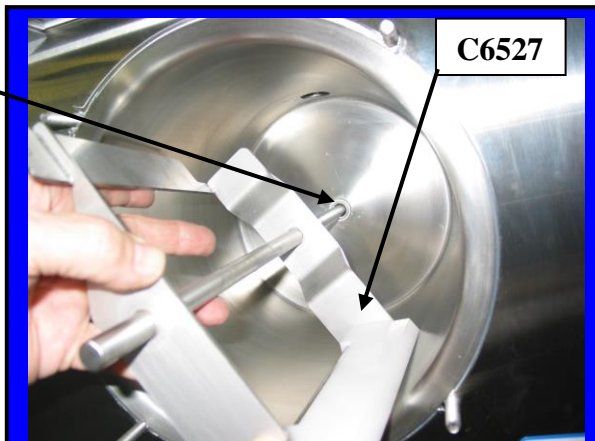

Carefully insert the large beater bar **C6527** (with beater seal) into the hole at the rear of the cylinder and rotate until it fully engages into the drive plate.

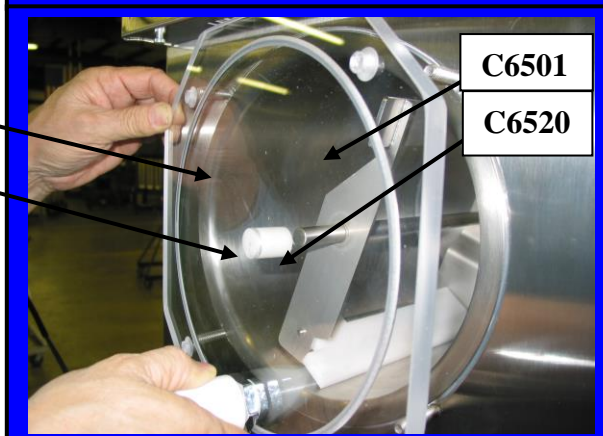

Re-install the large **faceplate** on the machine. First place the faceplate **bushing** onto the beater shaft. Then slide face plate onto the four studs. Install the faceplate knobs and tighten evenly until the faceplate O-ring is snug against the cylinder.

4.3 PREVENTATIVE MAINTENANCE

It is recommended that a maintenance schedule be followed to keep the machine clean and operating properly.

WARNING: Never attempt to repair or perform maintenance on machine until the main electrical power has been disconnected

A. DAILY

The exterior of the machine should be kept clean at all times to preserve the luster and sanitation of the stainless steel. A mild alkaline cleaner is recommended. Use a soft cloth or sponge to apply the cleaner.

B. WEEKLY

- (1) Check O-rings and rear seal for excessive wear and replace if necessary.
- (2) Clean faucet and faucet o-rings. Apply Petro-gel to O-rings and inside of faucet body.
- (3) Clean the drip tray and front of the freezer with a mild soap solution.

C. MONTHLY

CAUTION: Air-cooled condensers must have proper air circulation. Failure to clean the condenser on a regular basis may result in loss of refrigeration efficiency or serious damage and could void warranty.

- (1) Visually inspect the condenser for dirt by shining a light through the coil from the inside of the condenser.
- (2) If the condenser is dirty, place a wet towel over the outside of the condenser.
- (3) Using compressed air or a CO2 tank, blow out the dirt from the inside of the condenser. Most of the dirt will cling to the wet towel.
- (4) An alternative method of cleaning the condenser is to use a condenser brush and vacuum.

4.4 EXTENDED STORAGE

Refer to the following steps for storage of the machine over any long period of shutdown time:

- (1) Turn the three position switch to the OFF (center) position.
- (2) Disconnect (unplug) from the electrical supply source.
- (3) Clean thoroughly with a warm detergent all parts that come in contact with the mix. Rinse in clean water and dry all parts. Do not sanitize. Frozen Drink Machine parts can be left disassembled until ready for use.

NOTE: Do not let the cleaning solution stand in the hopper or in the cylinder during the shutdown period.

4.5 FACEPLATE/FAUCET ASSEMBLY

<u>Face Plate/Faucet Assembly</u>	<u>Part No.</u>
A. Face plate assembly with bushing	C6501
B. Faucet assembly with nut	C6513
C. Faucet body (only)	C6513B
D. Plunger assembly	C6513P

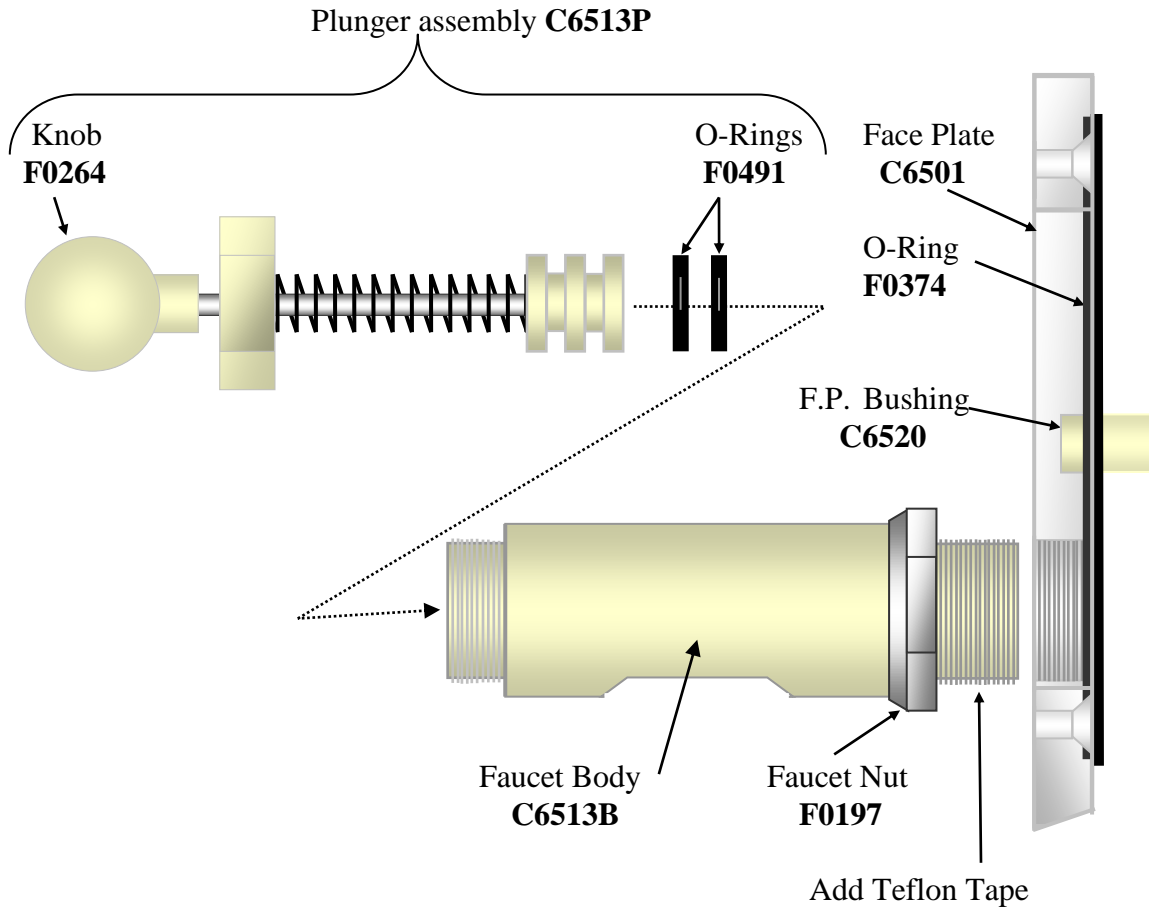

4.5 FACEPLATE / FAUCET ASSEMBLY (continued)



Applying Teflon Tape to **Faucet Body** before installation



Align Faucet Assembly opening to bottom of faceplate then tighten nut

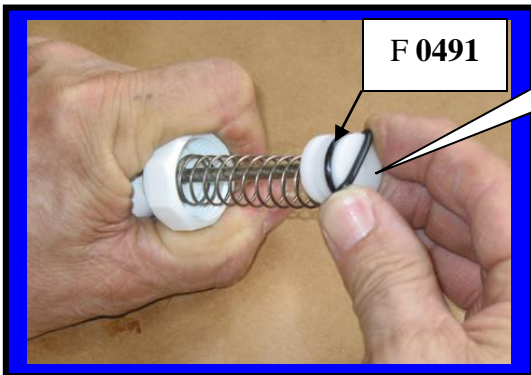

Install **O-rings** onto plunger

Lubricating O-rings with **Petro-Gel**



Installing **Plunger Assembly** into Faucet body



Installing large **Faceplate** onto front of Machine.



4.6 FLOAT SWITCH ASSEMBLY

1. The float switch assembly consists of: Post switch, Float, Float clip, O-Ring and Nut.
2. There are two dots or a raised ring, on one end of the float. When assembled the two dots or raised ring must be on the top end of the float.
3. Place O Ring so that it will be inside the hopper (sink bottom) when finished.

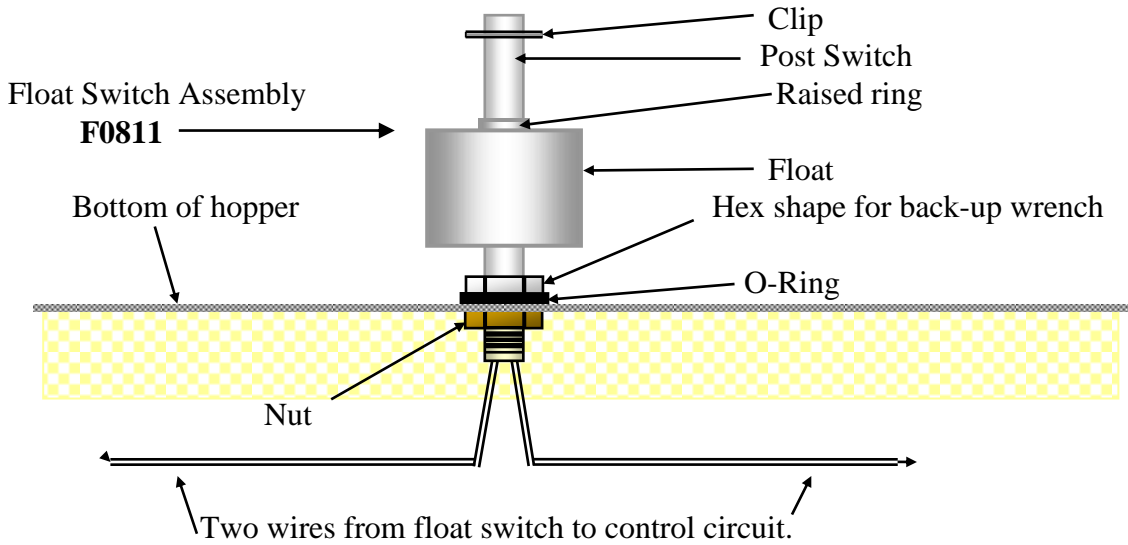

Top View of Float Switch

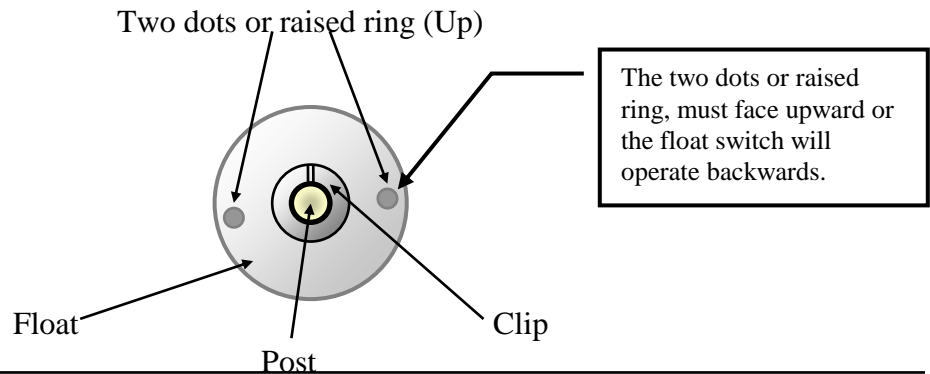

4.7 THERMOSTAT SYSTEM-STAND-BY

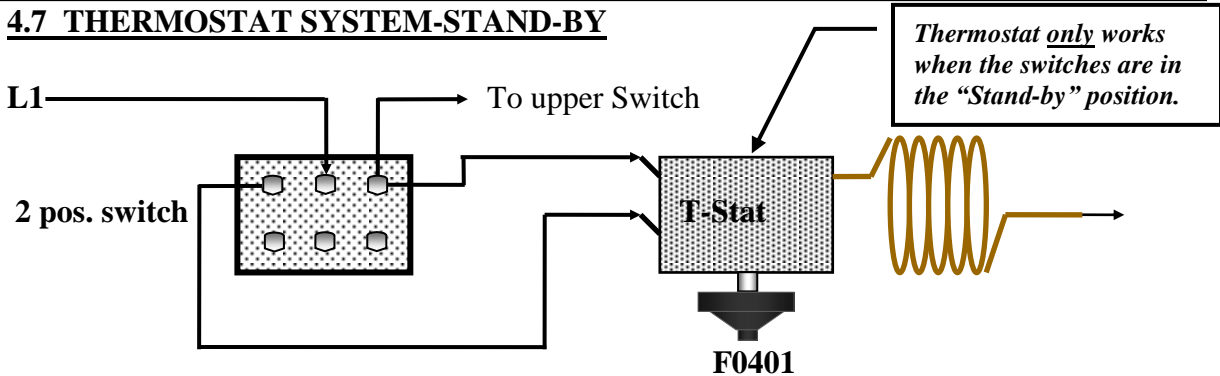

4.8 USING THE CLEANING BRUSHES

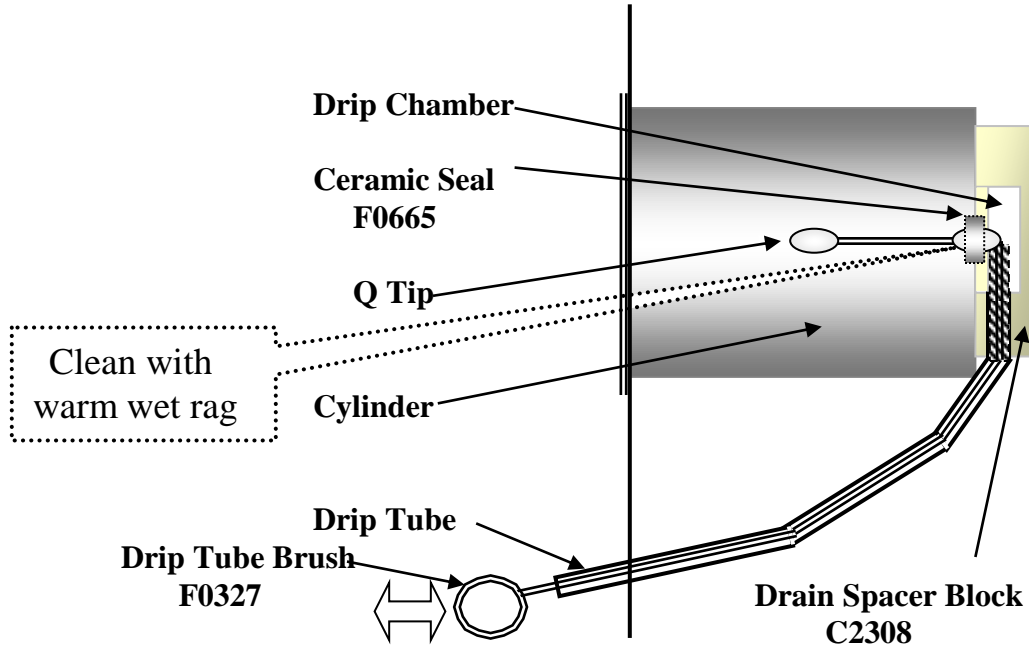

Insert long brush into drip tube

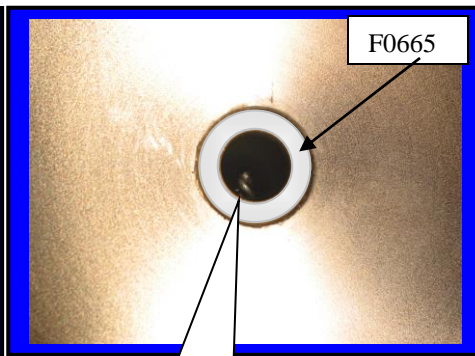

Push brush all the way in until it can be seen in the middle of the ceramic ring



Clean ceramic ring with warm, wet rag. Remove any dried product from center of ceramic ring.

4.9 BEATER BAR SEAL INSTALLATION

1. Using Petro-Gel (or other sanitary food grade lubricant), lightly lubricate the longer end of the beater shaft. Slide beater seal onto the shaft with the spring end toward the beater bar. (Refer to diagram in this section of your manual or on top of the hopper cover for correct installation of spring seal).
2. The black carbon ring must be facing the end of the beater bar so it will be in direct contact with the white ceramic seal inside the cylinder when the beater bar is re-installed. **This is a dry seal and must be kept free of lubricants.** Lube the beater bar shaft ONLY!
3. The beater seal may become damaged if the beater shaft is not lubricated before installation of the beater seal.

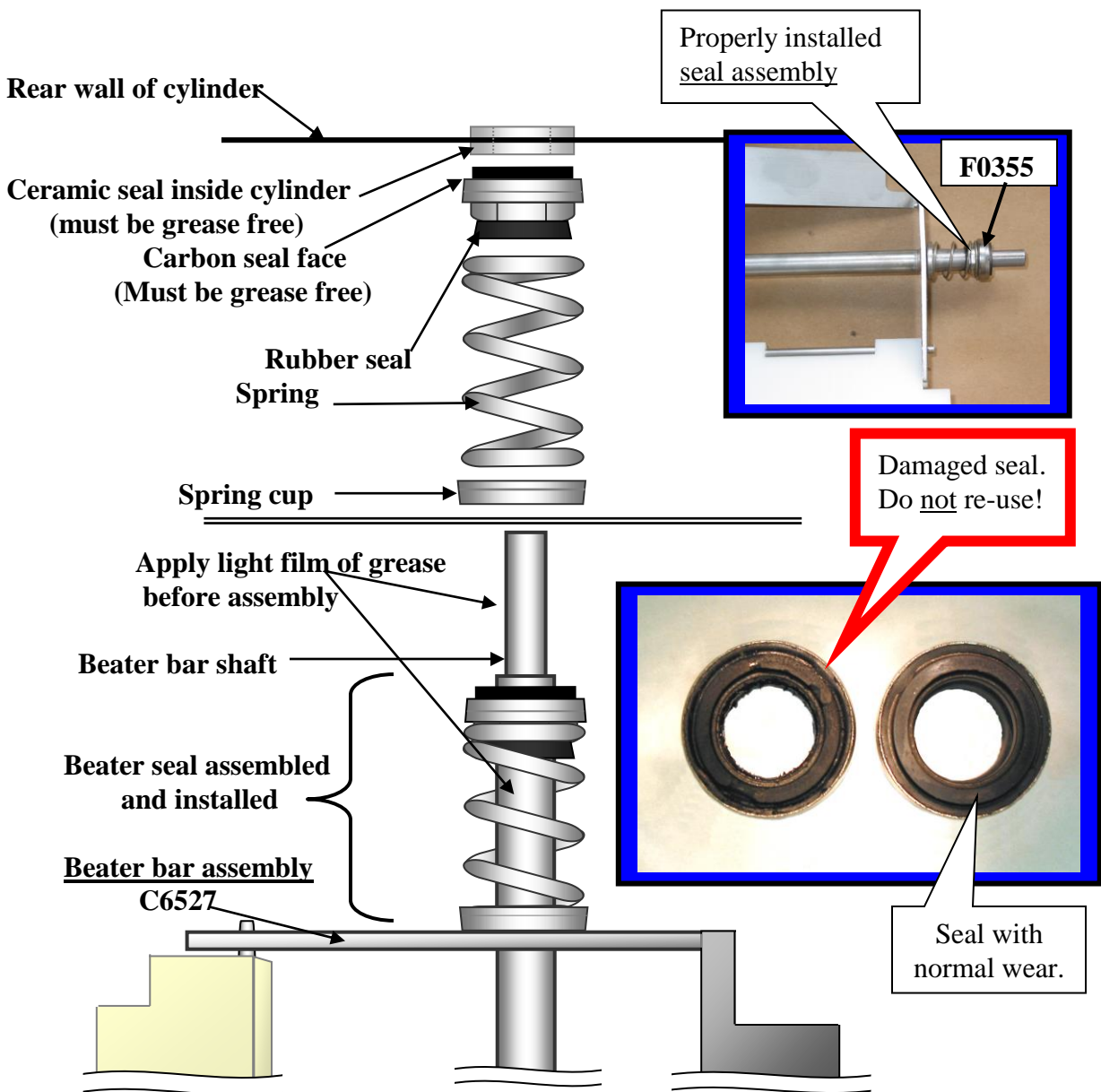

4.10 SCRAPER BLADE AND SPRING SEAL INSTALLATION

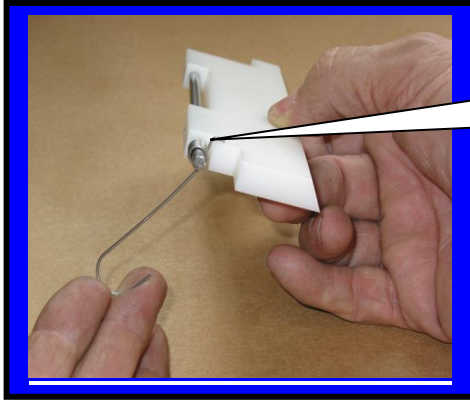

Step 1: Attach scraper blade spring F6512 as shown.

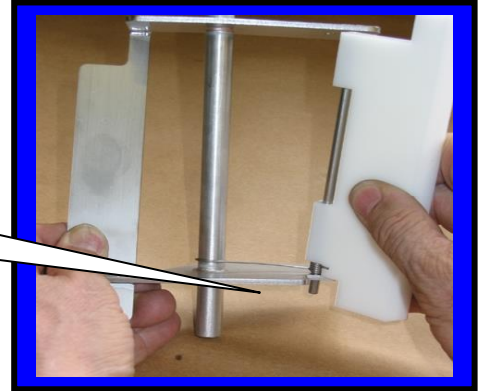

Step 2: Insert rod end into beater bar frame.



Step 3: Tap scraper blade rod until it is centered.

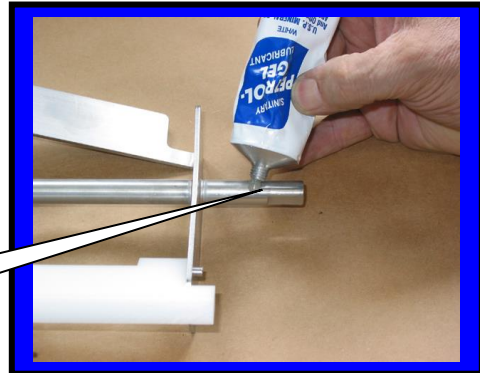

Step 4: Apply a small dab of Petro-Gel F0298

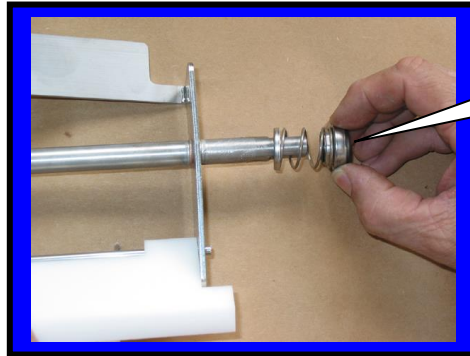

Step 5: Install spring seal F0355

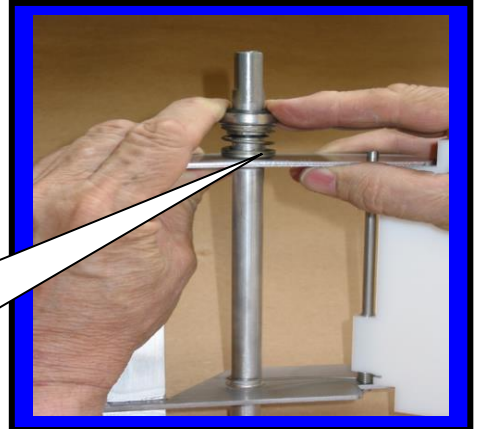

Step 6: Squeeze and release spring. Be sure the spring returns to normal before installing into machine.



Step 7: Install large beater bar assembly C6527 into cylinder.



Step 8: Install large faceplate C6501 onto machine

4.11 CERAMIC SEAL REMOVAL AND RE-INSTALLATION

Note: Use this procedure only when necessary to replace a damaged ceramic seal

To remove old seal:

1. Press the “Push button” on the puller tool to release the ball bearings.
2. Insert “T” handle through ceramic seal at rear of cylinder.
3. Release “Push button”.
4. Quickly pull “T” handle straight out and the ceramic seal will remain on the “T” handle as shown below.



Puller Tool F0012

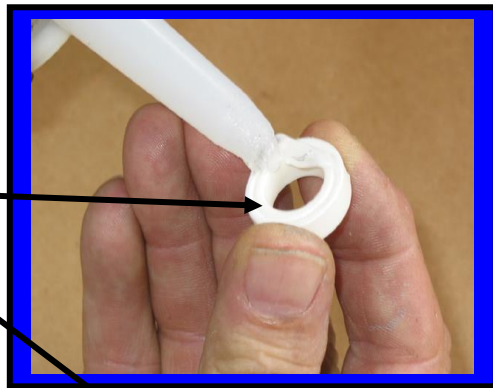

To install new seal:

1. Apply **silicone sealant** around rear, **grooved surface**, of ceramic seal (Put lubricant on the smooth side of the seal to prevent the silicone from sticking)
2. Press seal into hole at rear of cylinder. Silicone coated surface goes in first.
3. Gently tap ceramic ring with wood or plastic rod (**DO NOT USE METAL!**) until the seal has completely bottomed out.
4. The smooth surface of the ceramic seal must be completely clean in order to provide proper sealing when the beater bar with spring seal is installed.
5. If possible allow at least **four hours drying time** for silicone to cure before filling machine with product
6. Fill machine with product and check for leaks.
7. Machine is ready to run.



5.1 DRIVE BELT

All Frozen Drink Machine Models

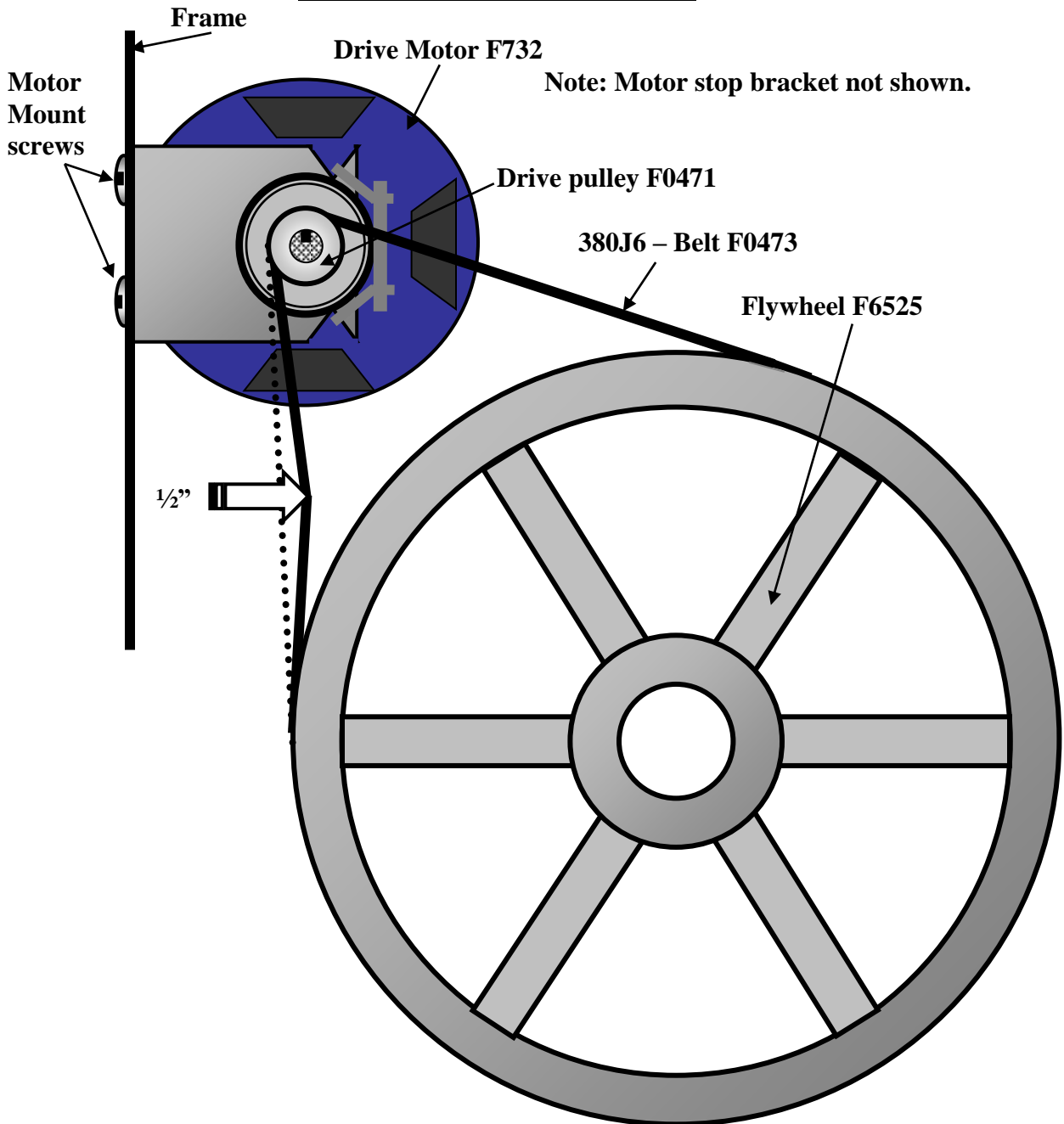

1. To increase belt tension, loosen the 4 motor mount screws and pry the entire motor assembly *up* until the belt is snug. Re-tighten the motor mount screws.
2. To test the belt tension, press on the belt at the mid-point (arrow). The belt should move easily for the first $\frac{1}{2}$ inch. It should be difficult to press the belt more than $\frac{1}{2}$ inch.
3. To align the drive pulley with the flywheel, loosen the Allen screw on the drive pulley and nudge the pulley forward or back as necessary.

5.2 FRANKLIN DRIVE MOTOR

All Frozen Drink Machine Models

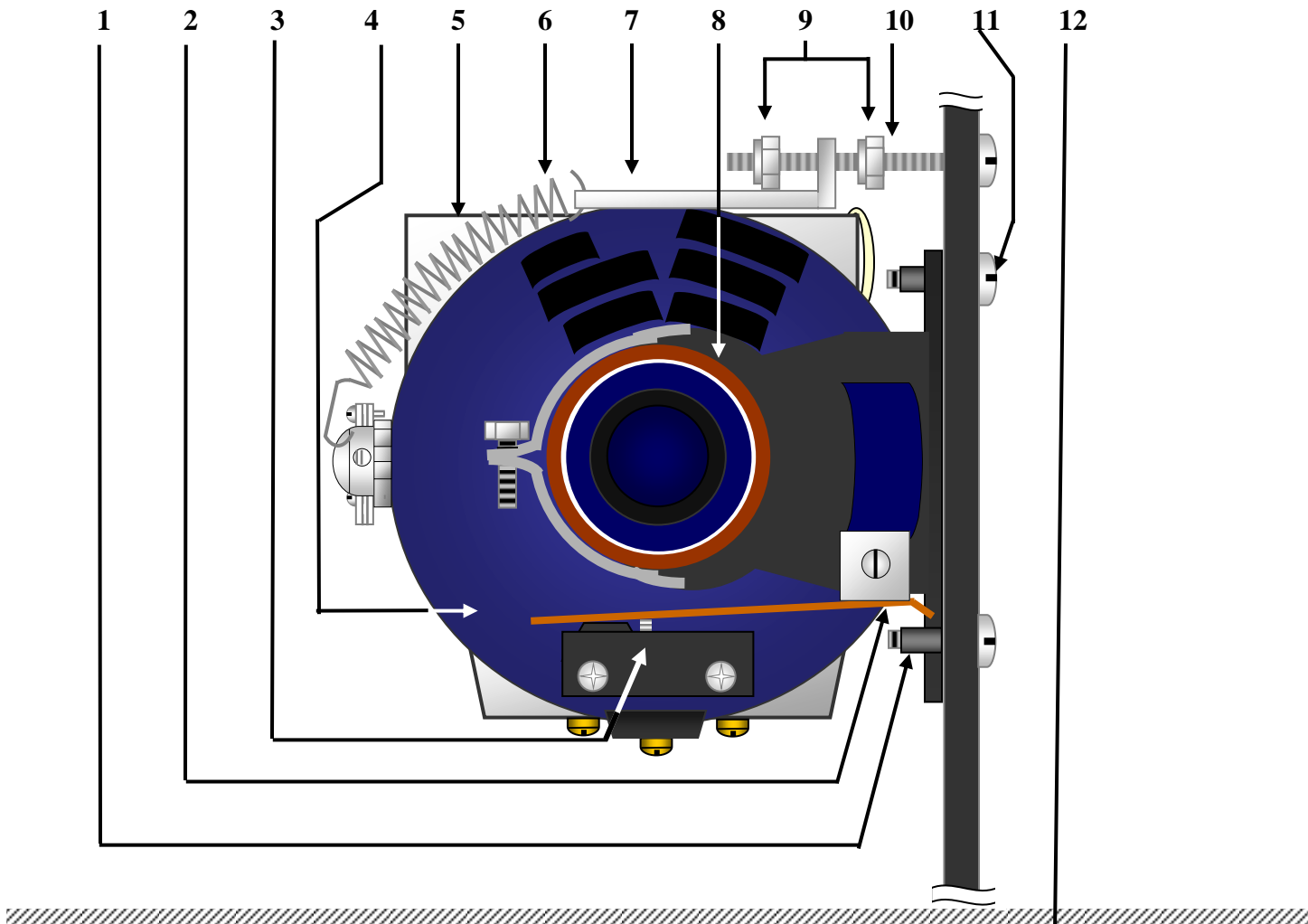

- | | |
|-------------------------------|-----------------|
| 1. U-Nuts (2) | 5/16-18 |
| 2. Microswitch Friction Plate | F tba |
| 3. Microswitch | F0346 |
| 4. Motor (Only) | F732 |
| Motor assembly | C732 |
| Includes items: 2,3,4,5,8,12. | |
| 5. Motor Stop Bracket | F1203 |
| 6. Tension Spring Lg | F0469 |
| 7. Spring Adjustment Bracket | F4202A |
| 8. Motor Bearing | F0738 |
| 9. Lock nuts (2) | 1/4-20 |
| 10. TCC Adjustment Screw | 1/2-20x3" |
| 11. Screw, Mtr mt. | 5/16"- 18 X 3/4 |
| 12. Motor Pulley | F0471 |

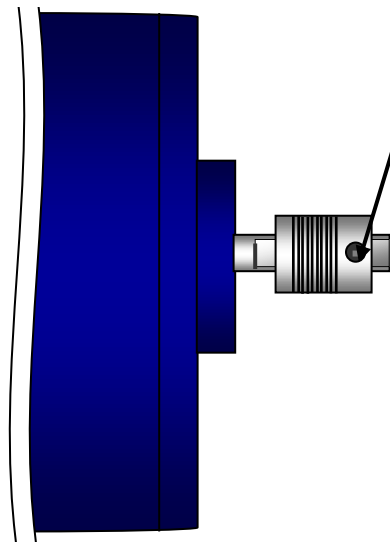

5.3 SHIM PLACEMENT

1. Disconnect power before servicing unit.
2. Insert alignment shaft into cylinder where the beater bar is normally installed.
3. Install Faceplate assembly and 2 knobs to hold faceplate on.
4. Turn flywheel slowly and observe spacing between the alignment shaft and the ceramic ring at the rear of the cylinder.
5. If the shaft appears to be touching the ceramic ring at the top, place a shim *between the bearing plate and the spacer block*. (see drawing on next page)

Alignment Shaft & Ceramic Ring Positions, as viewed from the **Front** of the machine.

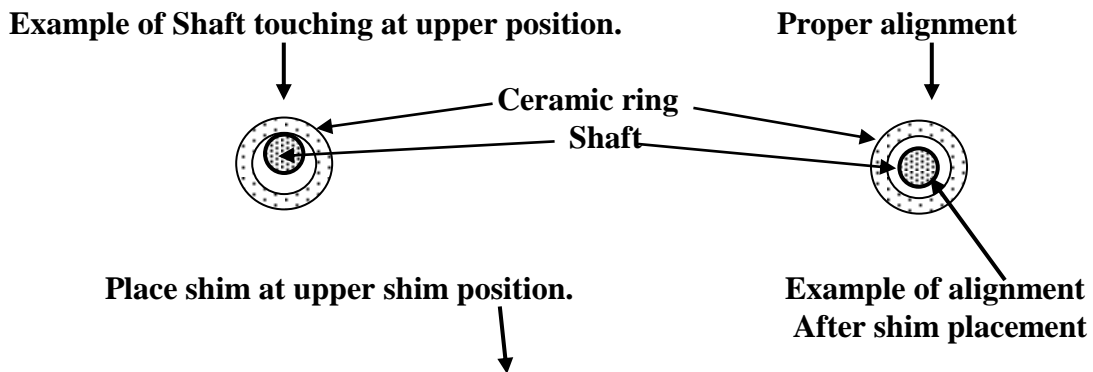

Example of upper shim placement as viewed from the **back** of the machine

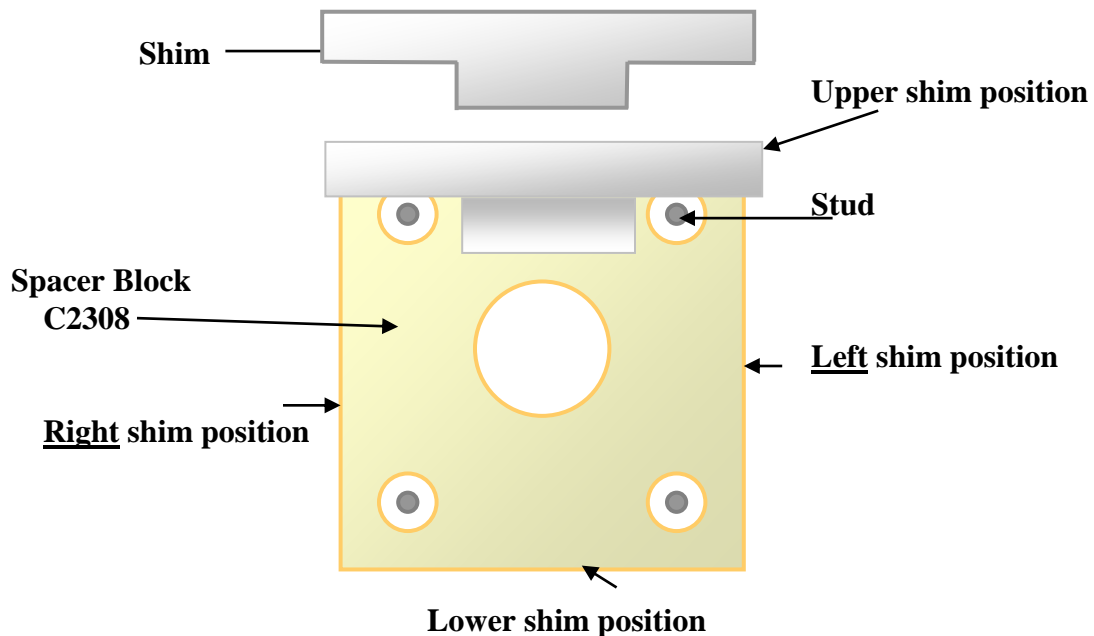

5.4 REAR CYLINDER ASSEMBLY

Belt Driven Models

Model Numbers; 137, 237, 232, 289, 235R

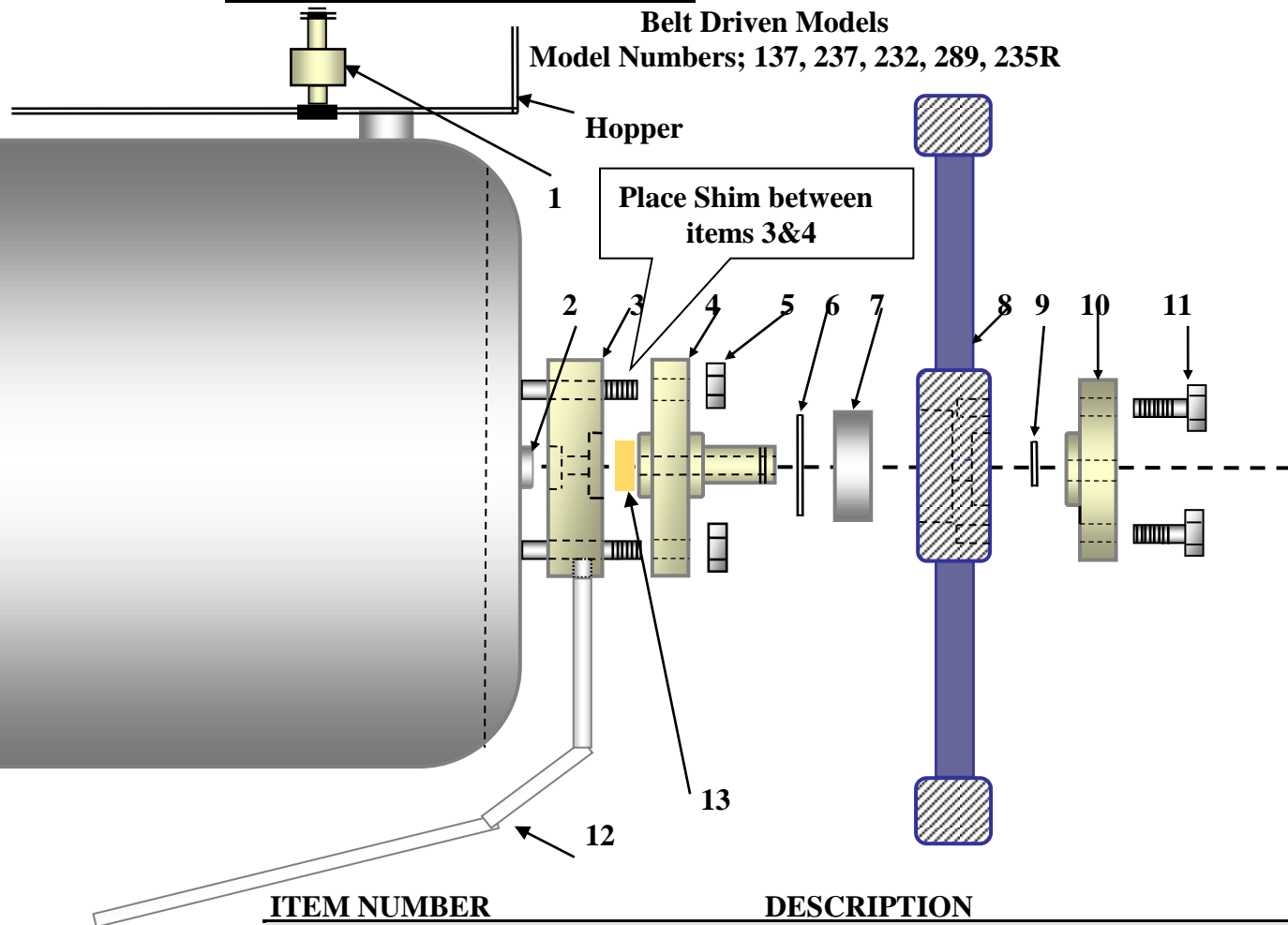

ITEM NUMBER	DESCRIPTION
1. F0811	Fill Light Switch
2. F0355*	Ceramic Seal
3. C2308	Spacer Block
4. C2306	Bearing Plate
5. 5/16-18	Bearing Plate Nuts
6. F0330	Large Clip Ring
7. F0267	Flywheel Bearing
8. F6525	Flywheel (only)
C6525	Assembly, Flywheel
(Includes items: 4,6,7,8,9,10)	
9. F0331	Small Clip Ring
10. C4403	Drive Plate
11. 5/16-18x1"	Drive Plate Bolts
12. F2309	1/2" Drain Tube(stainless steel)
13. F7057	Bearing Plate Seal (new 11-2015)

*Note: F0355 is the part # for the Spring Seal Assembly which includes the ceramic seal. (No. 2 above)

<p style="text-align: center;">SECTION 6 TROUBLESHOOTING</p>
--

1. **Machine does not run when turned on.**
 - A. Be sure that the cord is properly plugged into wall outlet.
 - B. Check to reset circuit breaker if necessary.
 - C. Be sure that no other appliances are sharing the circuit.

2. **Beater motor starts but compressor doesn't start.**
 - A. Both switches must be in the right (Snowflake) position.
 - B. Allow approximately one or two minutes for time delay to respond.
 - C. Check that the micro-switch at the drive motor is depressed.
 - D. If necessary adjust TCC screw to depress micro-switch.
 - E. Check electrical components in junction box.

3. **Mix dripping from drip tube.**
 - A. Spring seal on beater bar is dirty or improperly installed. Remove, clean and re-install spring seal assembly according to instructions and diagram on top of the hopper cover.
 - B. Ceramic seal (inside the freezing cylinder) is dirty or loose or greasy. Clean ceramic seal. If loose re-install as necessary. Also check that the carbon ring on the seal is not chipped, cracked, dirty or greasy. Replace seal if necessary.

4. **Unit runs but product does not freeze to desired consistency.**
 - A. Check recipe for proper amount of sugar.
 - B. Check TCC screw, if necessary turn clockwise to increase thickness of drink.
 - C. Check mix temperature. If temperature is below 25 degrees there may be too much alcohol in the recipe.
 - D. Check unit placement for adequate ventilation. (At least 8" clearance required on all sides.)
 - E. Check the condenser to see if it has become clogged with lint, dust etc. Clean as necessary.
 - F. Be sure the cylinder is full of mix.
 - G. Check that the micro-switch "clicks" at the mid-point of its rocking motion. Adjust as necessary.

5. **Unit runs but produces a loud knocking sound during initial freeze down cycle.**
 - A. Cylinder not full. Turn unit off and fill hopper with mix.
 - B. Ice build-up. Check recipe for proper amount of sugar.
 - C. To clear ice build-up, turn top switch to left (faucet) position until knocking stops then turn switch back to the right (snowflake) position. Repeat as necessary.

6. **Fill light is on when hopper is full of product.**
 - A. Remove and re-install float with two dots or raised ring, facing up.
 - B. If float is stuck, clean float and stem and re-assemble.

7. **Machine has gentle “rocking” motion.**
 - A. Air in cylinder- Turn unit off for about one minute to allow air to escape from cylinder. Cylinder must be full to freeze properly.
 - B. Be sure machine is level and all adjustable feet are touching counter top.

8. **No product comes out when faucet handle is pulled while unit is running.**
 - A. Frozen product is blocking “feed hole”. **Turn machine off** then clear ice plug from feed hole.
WARNING: Never place fingers in the “feed hole” as serious personal injury may occur.
 - B. Mix is frozen solid. Low sugar content, product separation or cylinder not full.

9. **Compressor starts and stops intermittently.**
 - A. Check to see that the fan is turning freely.
 - B. If the on/off time is 30 seconds or longer, this is normal if product is frozen and no product has been pulled in a while.
 - C. If the problem is causing the breaker to trip, check electrical components in junction box.

10. **Unit continues to run when switched to stand-by.**
 - A. Remove back panel and reset thermostat. (turn all the way off then turn all the way on again.)
 - B. If problem remains replace thermostat.

11. **Beater bar does not turn.**
 - A. Belt is broken. Replace as necessary.
 - B. Belt off pulley or loose. Check pulley alignment, re-install and tighten belt.
 - C. Mix is frozen solid. See item 8-B.
 - D. Drive plate stripped. Replace drive plate
 - E. Faulty motor. Replace motor

12. **Mix turns grey or pitting metal in the freezing barrel**
 - A. Too much chlorine in sanitizing solution: Follow directions on product package to get 100 parts/million chlorine solution. Stir this solution in the machine for 1-2 minutes only. **DO NOT ALLOW SANITIZING SOLUTION TO SIT IN THE MACHINE FOR ANY REASON!!!** If the barrel becomes saturated with chlorine apply chlorine neutralizer as needed to remove (obtain from swimming pool supply store).

SECTION 7 SPARE PARTS LIST

Rev. 10/21/09

7.0 SPARE PARTS FROZEN DRINK MACHINE MODELS

<u>ITEM NUMBER</u>	<u>DESCRIPTION</u>
Bearing, Flywheel	F0267
Bearing Plate	C2306
Bearing, Motor (Obsolete)	F0474
Bearing, Motor	F0738
Beater Bar Assembly, Lg.	C6527
Beater Bar Frame, Lg.	C6509
Beater Bar Spring Seal	F0355
Block, Spacer Lg.	C2308
Brush, Drip Tube, Lg.	F0327
Clip Ring, Lg.	F0330
Clip Ring, Sm.	F0331
Compressor ¾ H.P. 115/60/1 R404	F8053
Compressor ¾ H.P. 230/60/1 R404	F8054
Computer Board, Auto Fill 110Volt	F0577
Computer Board, Auto Fill 220Volt	F0562
Condenser, Air	F5557
Contactator	F0478
Drain Spacer Block	C2308
Drain Tube ½" SS	F2309
Drip Tray	F0195
Drip Tray Insert	F0196
Drip Tray Screws	F0905
Drip Tube Brush	F0327
Drive Belt	F0473
Drive Motor	F732
Drive Motor Assembly	C732
Drive Motor Pulley	F0471
Drive Plate	C4403
Dryer, Liquid Line 5Cu"	F5543
Face Plate	C6501
Face Plate Bushing	C6520
Face Plate Knobs	F0262
Fan Blade	F5558
Fan Motor Bracket	F5500
Fan Motor-115 Volt	F5559
Fan Motor-230 Volt	F5561
Fan Shroud	F5501
Faucet Assembly	C6513
Faucet Body	C6513B
Faucet Brush	F0326
Faucet Nut	F0197

<u>ITEM NUMBER</u>	<u>DESCRIPTION</u>
Faucet Plunger	C6513P
Faucet Spring	F0564
Fill Light	F0207
Float Clip	F0812
Float, Fill Light	F0804
Flywheel	F6525
Flywheel Assembly	C6525
Heat Sequencer	F0400
High Pressure Switch	F0661
Hopper Cover	F0497
Legs, 4" Stainless	F0800
Microswitch	F0346
Motor Spring Bracket	F1239
Motor Stop Bracket	F1203
O-Ring, Face Plate	F0374
O-Ring, Faucet	F0491
O-Ring, Fill Switch	F0161
Panel Louver	F0254 (Obsolete)
Panel, Left Side	F6405
Panel, Rear	F6407
Panel, Right Side	F6406
Petro-Gel	F0298
Puller tool (Ceramic ring)	F0012
Pulley, Drive Motor	F0471
Rear Cylinder Brace	F2005
Sanitizer	F0492
Scraper Blade	C6510F
Scraper Blade Spring	F6512
Sign Panel	F0170
Spring Adjustment Bracket	F4202A
Spring, Tension Lg.	F0469
Spring Seal Ceramic Ring 1/2"	F0665
Switch Nut	F7003
Switch, 2-Position, Bottom	F0417
Switch, 3-Position, Top	F0416
Switch, Fill Light (Float)	F0811
Thermostat	F0401
Time Delay (Adjustable)	F4998
Transformer (Multi-volt)	F4995

8.0 JUNCTION BOX

Typical Air cooled units

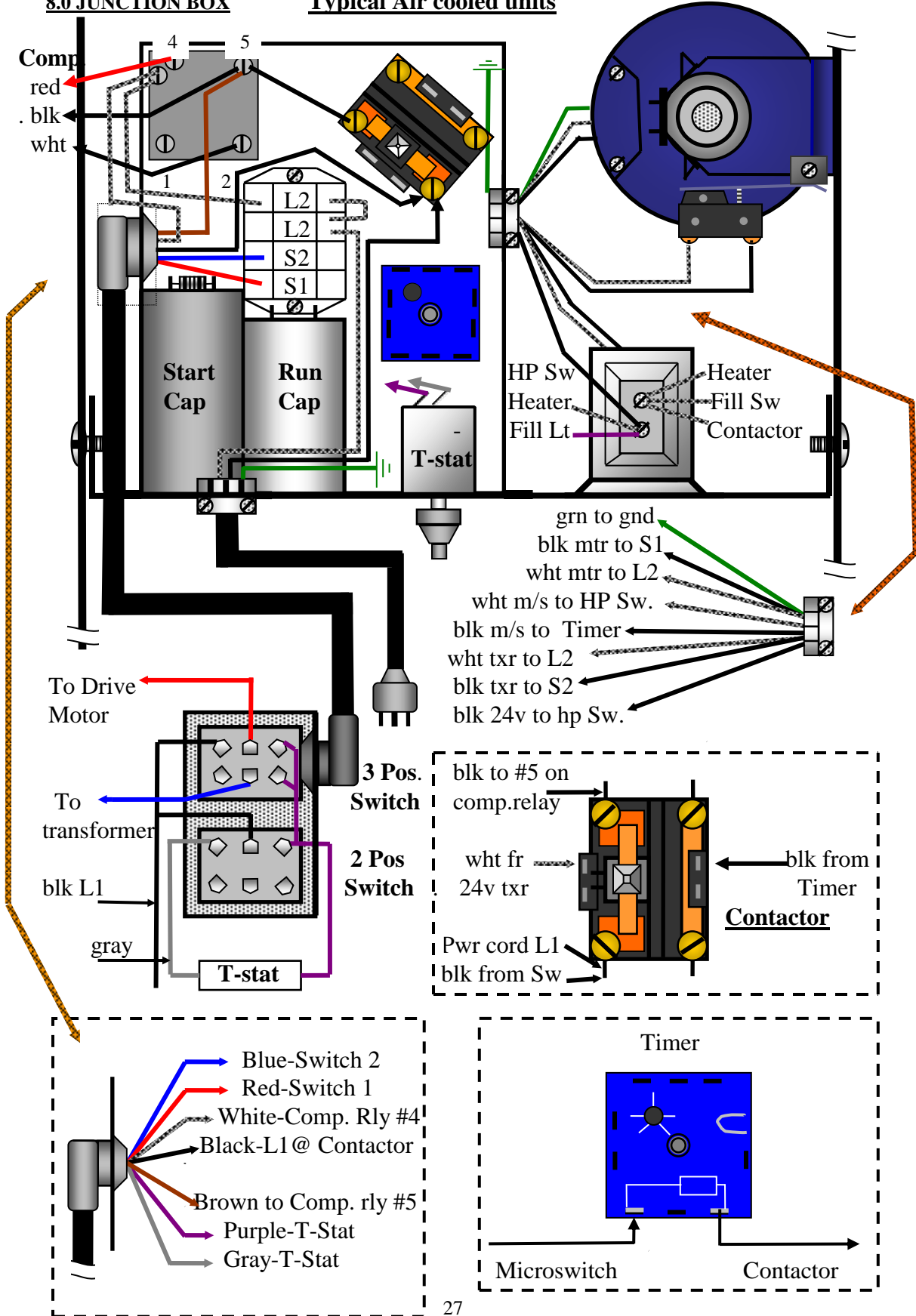

8.0 CONTACTOR & TIMER

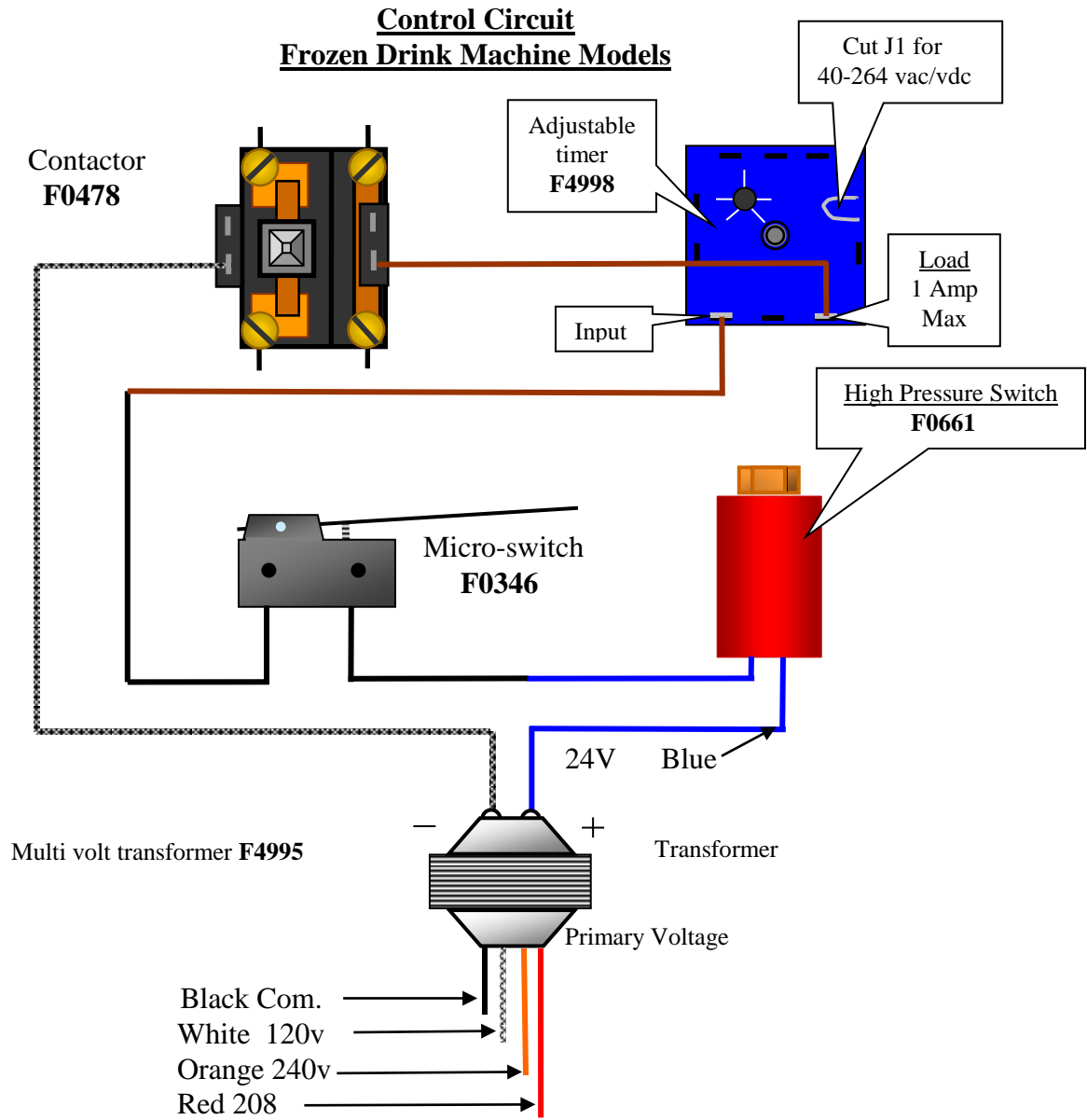

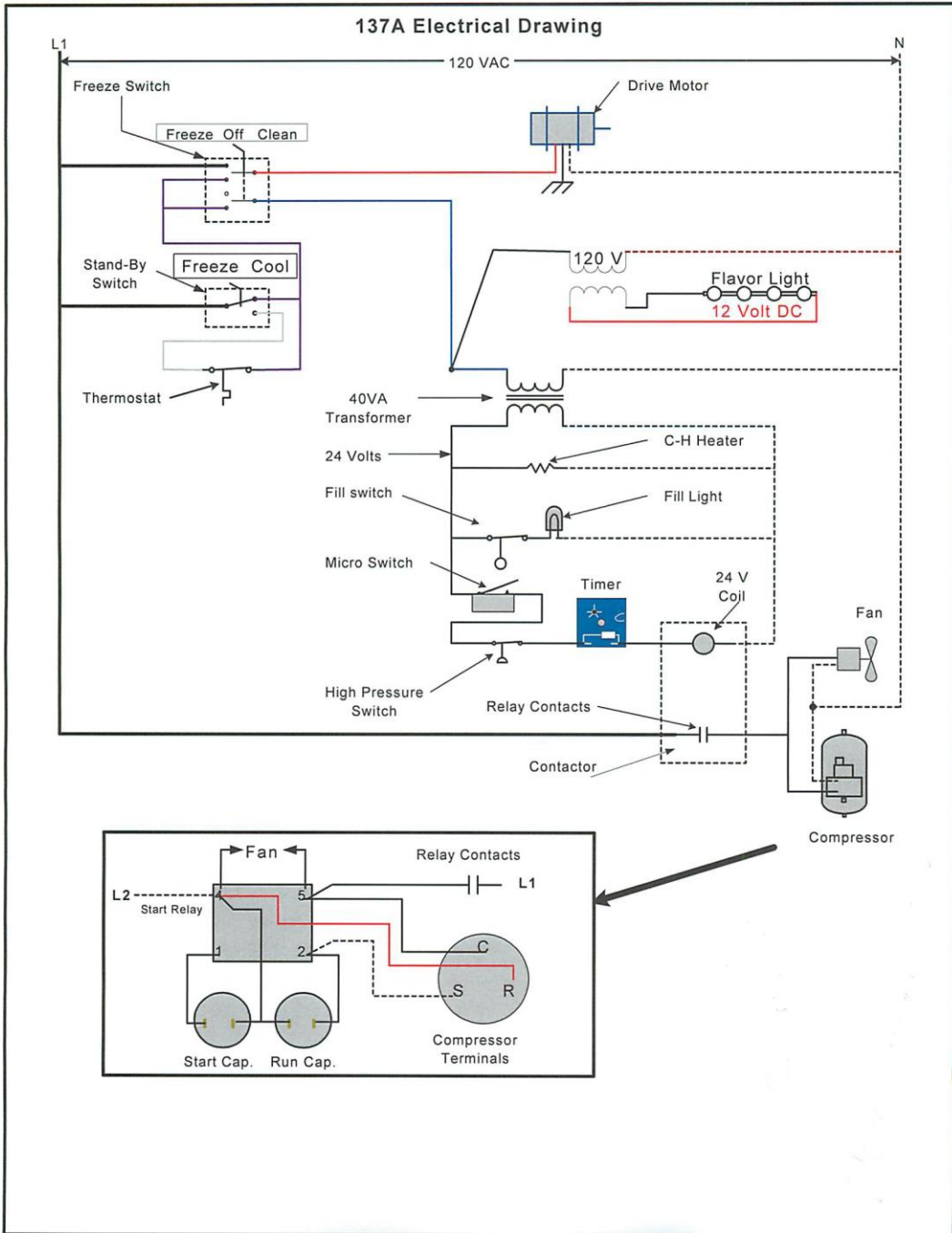



WARRANTY

Frosty Factory of America, Inc., the warrantor, providing that the conditions set forth herein are met by the Purchaser-User, warrants to the original purchaser-user that Frosty Factory Frozen Drinks machines, herein referred to as the "unit" is free from defects in factory workmanship and materials. This warranty is for the period of one year on all components of the unit with the exception of the compressor and the evaporator, which has a warranty period of five years. Also excluded are normal maintenance items i.e. O-rings, seals, belts, etc. During the warranty periods, Frosty Factory of America, Inc., agrees to repair or replace (at its option) without cost to purchaser-user except transportation charge any part or parts of said unit proved to the satisfaction of Frosty Factory of America, Inc. to be defective when sold. The warrantor shall not be responsible for any expenses incurred for service or repairs performed by a person or entity other than the Warrantor, unless specifically authorized by the Warrantor, and the repair falls in the 1 year labor warranty period. Past 1 year, service calls or repairs other than those covered by the conditions set forth in this Warranty will be made at the expense of the original Purchaser-User.

This warranty is in lieu of all other warranties, express or implied, including any warranties of merchantability or fitness for a particular use, and releases Frosty Factory of America, Inc. from all other obligations whatever. Frosty Factory of America, Inc. neither assumes nor authorizes any other person to assume from the warrantor any other liability in connection with the identified unit. This warranty is not assignable. "Original Purchaser-User" shall mean only such person or entity for which the identified unit is originally purchased and installed. Return of the OWNER'S WARRANTY CARD to the Warrantor is required for warranty coverage. If not received by the warrantor, warranty coverage begins the date of shipment.

All inquiries to our Factory about unit must be accompanied by the unit serial number.

This warranty does not apply to damage to said unit occurring in transit, or damage caused by unauthorized alternations, fire, accidents, artificially generated electric currents, Acts of God, misuse or abuse, or by any other cause whatsoever other than defects in Factory workmanship or material. This warranty does not apply to damage or loss of any products, refrigerant, property, or loss of income or profits due to the malfunctioning of said unit, nor to transportation or special charges for state sales or other taxes. This warranty also does not cover issues that are caused by lack of maintenance that is to be performed weekly as per cleaning instructions, nor is the adjustment of the viscosity for product thickness.

01/2016