

EHEI

Hot Food Tables

Models

- EHEI36C 2 well hot food table on casters
- EHEI36C-208 2 well hot food table on casters, 208v
- EHEI48C 3 well hot food table on casters
- EHEI60C 4 well hot food table on casters
- EHEI74C 5 well hot food table on casters



EHEI36C

Standard Features

- Stainless steel top and sides
- Individual wells with infinite controls
- 8" polyethylene cutting board
- Drains, manifold and common gate valve
- Fill faucet (shipped loose for field installation - left or right)
- Stainless steel plate shelf
- Stainless steel bottom shelf with 3" riser at rear
- Standard with cord and plug

Options & Accessories

- Composite cutting boards
- Counter protectors
- Overshelves (1-2 tiers)
- Stainless steel back
- Individual gate valves
- Cord and plug (leg models)
- 208V electrical (EHEI36L and C)

Specifications

Exterior: Top is one-piece heavy-gauge stainless steel with integral 2.12" square nosing on front with 90° turn down at the rear. Sides are heavy-gauge single thickness stainless steel with 2" bends on front and rear.

Top: Top is available with (2) to (5) 11.87" x 19.87" sealed individual wells to accommodate 12"x20" pans 6" deep. Each well is constructed of heavy-gauge stainless steel with 1/2" drains. Drains are manifolded together with common gate valve. Each well is individually controlled by infinite controls.

Controls are mounted on the front of the stainless steel plate shelf. Each well has a 1000 watt heating element with high limit safety switches.

Interior: Bottom shelf is heavy-gauge stainless steel with 3" high riser at the rear. 7" heavy-gauge stainless steel plate shelf on the front of the unit.

Electrical: (2) well units are standard with 120V or 208V electrical. (3) to (5) well units are standard with 208V electrical. All models are standard with relevant NEMA cord and plug.



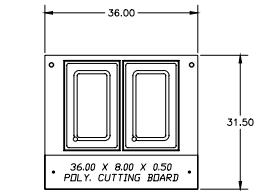

Plan View
EHEI36C, EHEI36C-208

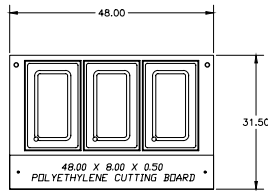

Plan View
EHEI48C

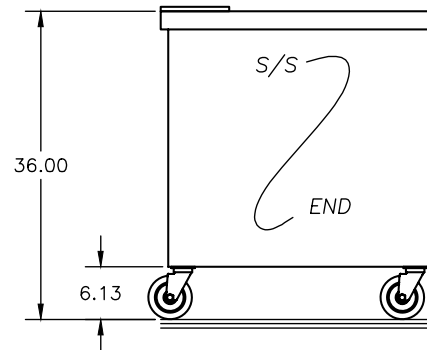

Side View
all EHEIxxC models

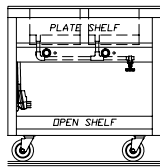

Elevation View
EHEI36C, EHEI36C-208

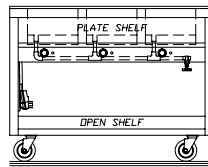

Elevation View
EHEI48C

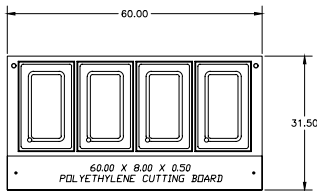

Plan View
EHEI60C

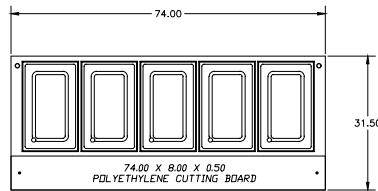

Plan View
EHEI74C

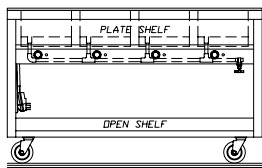

Elevation View
EHEI60C

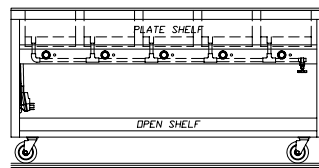

Elevation View
EHEI74C

Specifications											
Model	Length	Depth	Height	Pans	Voltage	Amps	Hz	Phase	Nema Plug	Ship Weight	
EHEI36C	36"	31.5"	36"	2	120	17.0	60	1	5-30P	250	
EHEI36C-208	36"	31.5"	36"	2	208	10.0	60	1	6-15P	250	
EHEI48C	48"	31.5"	36"	3	208/230	15.0/16.0	60	1	6-20P	280	
EHEI60C	60"	31.5"	36"	4	208/230	20.0/22.0	60	1	6-30P	310	
EHEI74C	74"	31.5"	36"	5	208/230	24.0/27.0	60	1	6-50P	350	

Welbilt reserves the right to make changes to the design or specifications without prior notice.

EHEI