



Merrychef **eikon**[®] **e1s** high speed oven

US/CA

Microwave combination oven
Service and repair guide – USA/Canada

Part number: 32Z9001



 Read instructions before use

Expanding your opportunities™



www.merrychef.com

Safety symbols used in this document or on appliance

Symbols on appliance

Area	Symbol	Descriptionsosidrive
1		Microwaves warning There is a risk of external and internal burns of body parts following exposure to microwave energy.
2		Electric shock warning There is a risk of electric shock if the appliance is serviced without disconnecting the electrical supply.
3		Fire / electric shock warning There is a risk of fire / electric shock if the appliance is operated without respecting the minimum clearances.
4		Hot surface warning There is a risk of burns from high temperatures inside the cavity and on the inside of the appliance door.
5		Electric shock warning There is a risk of electric shock if the electrical power is not connected to a properly grounded outlet.
6		Equipotential bonding

Symbols in document

Symbol	Meaning
	Warnings of potential injuries. Heed all the warning notices that appear after this symbol to avoid potential injuries or death.
	See Operations Guide or section specified.



Warning notices

Hazard level	Consequences	Likelihood
⚠ DANGER	Death / serious injury (irreversible)	Immediate risk
⚠ WARNING	Death / serious injury (irreversible)	Potential risk
⚠ CAUTION	Minor injury (reversible)	Potential risk
⚠ DAMAGE	Damage to property	Potential risk





Symboles de sécurité utilisés dans ce document ou sur appareil





Symboles sur l'appareil

Zone	Symbole	Descriptions
1		Alerte micro-ondes Risque de brûlures externes et internes de parties du corps suite à exposition à l'énergie du micro-ondes.
2		Avertissement choc électrique Risque de choc électrique si l'appareil est entretenu sans débrancher l'alimentation électrique.
3		Avertissement incendie / choc électrique Risque d'incendie / de choc électrique si l'appareil est actionné sans respecter les espaces libres minimaux.
4		Avertissement de surface chaude Risque de brûlures par les hautes températures siégeant dans l'enceinte de cuisson et à l'intérieur de la porte de l'appareil.
5		Avertissement choc électrique Risque de choc électrique si l'alimentation électrique n'est pas raccordée sur une prise correctement mise à la terre.
6		Liaison équipotentielle

Symboles dans le document





Symbole	Signification
	Avertissement sur des blessures potentielles. Respecter tous les avertissements apparaissant après ce symbole pour éviter les blessures potentielles voire la mort.
	Voir le Guide d'utilisation ou la section spécifiée.

Notifications d'avertissement

Niveau de risque	Conséquences	Probabilité
 DANGER	Mort / blessure grave (irréversible)	Risque immédiat
 AVERTISSEMENT	Mort / blessure grave (irréversible)	Risque potentiel
 PRUDENCE	Blessure mineure (réversible)	Risque potentiel
 DOMMAGE	Domage matériel	Risque potentiel



FOR THE INSTALLER, OPERATOR, RESPONSIBLE OWNER

	<p>WARNING</p> <p>Improper installation, adjustment, alteration, service or maintenance can cause property damage, injury and death. Read the installation, operating and maintenance instructions thoroughly before installing or servicing this equipment.</p>
	<p>WARNING</p> <p>PRECAUTIONS TO AVOID POSSIBLE EXPOSURE TO EXCESSIVE MICROWAVE ENERGY</p> <ul style="list-style-type: none"> ▷ Do not attempt to operate this oven with the door open since open-door operation can result in harmful exposure to microwave energy. It is important not to defeat or tamper with the safety interlocks. ▷ Do not place any object between the oven front face and the appliance door or allow soil or cleaner residue to accumulate on sealing surfaces. ▷ Do not operate the oven if it is damaged. It is particularly important that the oven door closes properly and that there is no damage to the (1) door (bent), (2) hinges and latches (broken or loosened), (3) door seals and sealing surfaces. ▷ The oven should not be adjusted or repaired by anyone except properly qualified service personnel.
	<p>WARNING</p> <p>Disconnect power at the main external power switch before servicing or repairing a microwave combination oven.</p>
	<p>WARNING</p> <p>To reduce the risk of electric shock, do not remove or open cover. No user serviceable parts inside. Refer servicing to qualified personnel. Disconnect power supply before servicing.</p>

IMPORTANT

Customer documentation

- The customer documentation is part of the microwave combination oven.
- Keep the customer documentation manuals handy at all times so that you can look up any required information.
- Keep the customer documentation manuals for the entire life of the appliance.
- Carefully read the installation and operating manual before using, handling, and working on this appliance.
- If you transfer the microwave combination oven to a new owner, make sure to give the new owner the customer documentation manuals as well.



À L'ATTENTION DE L'INSTALLATEUR, DE L'OPÉRATEUR, DU PROPRIÉTAIRE RESPONSABLE

	AVERTISSEMENT
	L'installation, le réglage, la modification, la réparation ou l'entretien incorrect de cet appareil peut causer des dommages matériels, des blessures ou la mort. Lire attentivement les instructions d'installation, de fonctionnement et d'entretien avant de procéder à son installation ou entretien.

	AVERTISSEMENT
	PRÉCAUTIONS POUR ÉVITER L'EXPOSITION EXCESSIVE POSSIBLE À L'ÉNERGIE MICRO-ONDES <ul style="list-style-type: none">▷ Ne pas tenter d'opérer ce four lorsque la porte est ouverte puisque le fonctionnement avec la porte ouverte peut résulter en une exposition dangereuse à l'énergie micro-ondes. Il est important de ne pas trafiquer les dispositifs du verrouillage sécuritaire.▷ Ne jamais placer d'objet entre l'avant du four et la porte ou permettre aux saletés ou aux résidus du nettoyeur de s'accumuler sur les surfaces d'étanchéité.▷ Ne pas utiliser le four si celui-ci est endommagé. Il est particulièrement important que la porte se ferme correctement et qu'il n'existe aucun signe de dommage sur (1) la porte (pliée), (2) les charnières et les verrous (cassés ou desserrés), (3) les joints de la portes et les surfaces d'étanchéité.▷ Le four ne devrait pas être ajusté ou réparé par personne d'autre que le personnel de service qualifié.

	AVERTISSEMENT
	Avant toute intervention de maintenance ou de réparation sur un four mixte, débrancher l'alimentation électrique à l'aide de l'interrupteur général externe.

	AVERTISSEMENT
	Afin de réduire le risque d'électrocution, ne pas retirer ou ouvrir le capot. Aucune pièce réparable ne se trouve à l'intérieur. Confier le dépannage à du personnel qualifié. Débrancher l'alimentation électrique avant réparation.

IMPORTANT

Utilisation de la documentation client

- La documentation client fait partie du four mixte.
- Garder les manuels d'utilisation de la documentation client à votre disposition, pour consultation à tout moment.
- Conserver les manuels de la documentation client sur toute la durée de vie de l'appareil.
- Veuillez lire soigneusement le manuel d'installation et le manuel d'utilisation avant de manipuler cet appareil.
- En cas de cession du four mixte, joindre à celui-ci les manuels de la documentation client.



Table of contents

Safety symbols used in this document or on appliance	2
Symboles de sécurité utilisés dans ce document ou sur appareil	3
Document information	10
Section 1: Safety	11
1A. Environmental protection	13
Statement of principles	13
Environmental protection procedures	13
1B. Identifying your microwave combination oven	14
Position of nameplate	14
1C. General safety / Sécurité générale	15
Basic safety code	15
IMPORTANT SAFETY INSTRUCTIONS	17
CONSIGNES DE SÉCURITÉ IMPORTANTES	19
Other safety considerations and instructions	21
1D. Summary of design, operational hazards and safety devices	24
Warning and safety signs	24
Parts and safety devices	24
Hazard points	27
Risques	27
Intended use of your microwave combination oven	28
1E. Requirements to be met by operating personnel working positions	29
1F. Hazards and safety precautions during installation and setting up	30
Personal protective equipment requirement	30
Safety precautions relating to the installation location	30
Grounding instructions	31
Instructions de mise à la terre	31
Potential risks during installation and setting up	32
1G. Hazards and safety precautions when preparing appliance for use	33
Personal protective equipment requirement	33
Safety precautions for preparation for first use	33
1H. Hazards and safety precautions during operation	34
Personal protective equipment requirement	34
General rules	34
Restrictions on use	34
Instructions for safe use of the appliance	34
Potential risks during operation	35
Risques potentiels pendant l'utilisation	36



1I.	Hazards and safety precautions during cleaning	38
	Personal protective equipment requirement.....	38
	General cleaning safety rules and requirements.....	38
	Potential risks during cleaning.....	38
1J.	Hazards and safety precautions during servicing and repair	40
	Personal Protective Equipment.....	40
	Potential risks to move appliance.....	40
	Rules for moving and setting up the wheeled trolley safely.....	40
	Risk of burns.....	41
1K.	Hazards and safety precautions when taking the appliance out of service	42
	Personal protective equipment.....	42
	General precautions.....	42
	Potential risks.....	42
	Section 2: Operations and Installation	43
2A.	Introduction to e1s	44
	Identifying your microwave combination oven.....	44
	Appliance parts and their functions.....	44
	Equipment and accessories supplied.....	46
2B.	Installing the appliance	47
	Unpacking.....	47
	Taking the appliance off the pallet.....	47
	Installation location requirements.....	48
	Electrical installation requirements.....	49
2C.	Getting started	51
	Fitting the air filter.....	51
	Inserting the cook plate.....	51
	Turning the oven on and off.....	51
	Settings on first usage.....	52
	Selecting suitable utensils.....	53
	Preheating the oven.....	53
	Understanding the main menu and keyboard.....	54
2D.	Cooking procedures	55
	How to cook.....	55
	Using a cooking profile – quick serve mode.....	56
	Using a cooking profile – full serve mode.....	57
	Choosing cooking profiles for Press&Go menu.....	58
	Changing the cavity temperature.....	58
2E.	Cooking profiles	60
	Creating a cooking profile.....	60
	Viewing and editing cooking profiles.....	61



Moving a cooking profile in a group of cooking profiles.....	61
Moving a cooking profile in a list.....	62
Adding a new cooking profile group.....	62
Adding a cooking profile to a group of cooking profiles.....	63
Deleting a cooking profile group.....	63
Editing a selected cooking profile group name.....	64
2F. Changing settings.....	65
Changing settings process.....	65
Operating mode / navigation settings.....	66
Language settings.....	66
Cavity temperature settings and labels.....	67
Service information and error logs.....	68
Cooking profile counters.....	68
Setting the date and time.....	69
Sound settings.....	70
Temperature timer setting.....	71
USB program downloads.....	72
Temperature band setting.....	73
Change setting / service access password.....	73
Set screen saver.....	74
2G. Cool-down procedures.....	75
2H. Cleaning procedures.....	76
Daily cleaning tasks.....	76
Cleaning instructions.....	77
2I. End of day operations.....	80
Turning the oven off.....	80
2J. Warranty information and contacting customer services.....	81
Section 3: Service and Repair.....	82
3A. Technical data summary.....	83
Dimensions and weight.....	83
Electrical specifications.....	83
Power and heat.....	83
Noise emission.....	83
Regulatory standards compliance.....	83
Dimensional drawings.....	84
3B. Diagnostics.....	85
Checking the condition of your appliance.....	85
Entering Service Mode.....	85
Errors and diagnostics.....	86
Health checks of components.....	89



3C. Fault Finding	93
Error code list	93
3D. Tests	95
Test types	95
Equipment required for tests	95
Testing selected components (casing mounted)	96
Microwave Leakage test	97
Temperature Control test: measuring the cavity temperature	99
Recommission test	101
Commissioning the oven after service/repair/testing	102
High voltage components (casing removed)	103
Mains voltage components (casing removed)	105
3E. Firmware updates	107
Procedures to load USB sticks and download to appliance	107
3F. Replacing components	116
Safe working when replacing appliance parts	116
Overview of parts	118
Removing / fitting the casing	120
Removing / fitting the door assembly and door seal	121
Replacing a magnetron	124
Replacing the cooling fan	127
Replacing the QTS (Quick Touch Screen) assembly	128
Replacing the SRB (Smart Relay Board)	130
Replacing the touchscreen overlay	131
Adjusting the door microswitches	132
Replacing the impinger plate	134
Replacing the stirrer	135
Replacing the stirrer motor	137
Replacing the convection fan motor and heating element	138
Replacing a transformer (high voltage)	140
Replacing the convection fan motor speed controller	142
Overview of further components	143
3G. Circuit boards and diagrams	145
QTS circuit board assembly	145
SRB circuit board	146
Circuit diagrams	147



Document information

Version control

Date	Issue number	Description	Issued by
24 January 2020	02	Safety instructions, operation and installation and service and repair procedures	Merrychef

Document purpose

This guide should be read prior to servicing or repairing the appliance.

This document is intended for all trained service technicians who work with the Merrychef eikon e1s microwave combination oven, and provides them with the necessary information for carrying out servicing and repair work properly and safely.

This document must be read and understood without fail by those that will come in to contact with the appliance. If the information is not followed, there is risk of fatality, injury and property damage.



Section 1: Safety



Important information / Information importante

Users are cautioned that maintenance and repairs should be performed by a Merrychef authorized service agent using genuine Merrychef replacement parts. Merrychef will have no obligation with respect to any product that has been improperly installed, adjusted, operated or not maintained in accordance with national and local codes or installation instructions provided with the product, or any product that has its serial number defaced, obliterated or removed, or which has been modified or repaired using unauthorized parts or by unauthorized service agents. For a list of authorized service agents please refer to your distributor.

Les utilisateurs sont avisés que l'entretien et les réparations devraient être effectués par un agent de service autorisé de Merrychef utilisant des pièces de rechange d'origine Merrychef. Merrychef rejette toute responsabilité relativement à tout produit qui a été installé, ajusté, utilisé incorrectement ou qui n'est pas entretenu conformément aux codes fédéraux, provinciaux et locaux ou aux instructions d'installation fournies avec l'appareil, ou à tout produit dont le numéro de série a été abîmé, effacé ou enlevé, ou qui a été modifié ou réparé en utilisant des pièces non-autorisées ou par des agents de service non-autorisés. Pour la liste des agents de service autorisés, se référer à la dernière page de ce manuel. Les renseignements contenus dans ce manuel (incluant les spécifications de la conception et des pièces) peuvent être remplacés et sont sous réserve de changements sans préavis.



1A.Environmental protection

Welbilt employs a quality management system in accordance with EN ISO 9001:2008 and a certified environmental management system in accordance with EN ISO 14001.

Statement of principles

Our customers' expectations, the legal regulations and standards and our company's own reputation set the quality and service for all our products.

We have an environmental management policy that not only ensures compliance with all environmental regulations and laws, but also commits us to continuous improvement of our green credentials.

We have developed a quality and environmental management system to guarantee the continued manufacture of high-quality products and to be sure of meeting our environmental targets.

This system satisfies the requirements of ISO 9001:2008 and ISO 14001:2004.

Environmental protection procedures

We observe the following procedures:

- Use of RoHS2-compliant products
- REACH chemical law
- Recycling of electronic waste
- Environmentally friendly disposal of old appliances via the manufacturer



1B. Identifying your microwave combination oven

Position of nameplate

The nameplate is located on the rear of your microwave combination oven and contains various pieces of information as detailed below.

	No	Item
	1	Model Number
	2	Serial Number <ul style="list-style-type: none"> • Year of manufacture • Month of manufacture • Place of manufacture • Production number
	3	Regulatory Compliance <ul style="list-style-type: none"> • WEEE • CE • NFPA Ventilation Compliance • UL/Canada
	4	Technical Data <ul style="list-style-type: none"> • Supply Voltage • Maximum Phase Current • Maximum Power Supply • Output Microwave Power • Output Convected Power • Microwave Frequency
5	Design and Production Details: <ul style="list-style-type: none"> • Designed by • Manufacturing Site • Brand HQ details 	

Figure 1.1: Nameplate



1C. General safety / Sécurité générale

The information in this section should be read and understood by Facility Managers, Chefs, Users and Service Technicians.

Basic safety code

Object of this safety code

This safety code aims to ensure that all persons who use the microwave combination oven have a thorough knowledge of the hazards and safety precautions, and that they follow the warning notices given in the Installation and User manual and on the appliance. If you do not follow this safety code, you risk potentially fatal injury and property damage.

Referring to the Installation and Operation Manual

Follow the instructions below:

- Read in full Section 1C of this service and repair guide and the chapters that relate to your work.
- Pass on the service and repair guide with the microwave combination oven if it changes ownership.

Personal protective equipment for your personnel

Instruct your personnel to wear the correct personal protective equipment specified for each task in the relevant sections.

Basic rules for installation

The appliance must be installed in compliance with all national and state laws and regulations, with all applicable local requirements and regulations set forth by the relevant local utility companies and authorities, and with all other relevant regulations and standards.

These include, but are not limited to:

- The National Electrical Code, ANSI/NFPA 70 (current edition)
- The Canadian Electrical Code, CSA C22.1
- The Food Code and Food Service Sanitation Manual published by the Food and Drug Administration (FDA) (current editions)
- The standards published by the National Sanitation Foundation (NSF)
- All local fire protection and occupational health and safety regulations

Règles de base pour l'installation

L'installation doit s'effectuer conformément à toutes les lois et prescriptions étatiques et fédérales, ainsi qu'aux prescriptions locales des opérateurs et autorités locales ainsi qu'aux autres directives applicables.

Outre les autres prescriptions doivent également être respectés:

- National Electrical Code, ANSI/NFPA 70 (édition actuelle)
- Canadian Electrical Code, CSA C22.1
- Food Code et Food Service Sanitation Manual de la Food and Drug Administration (FDA) (édition actuelle respective)
- Prescriptions de la National Sanitation Foundation (NSF)
- Toutes les prescriptions en matière de protection incendie, sécurité au travail et protection sanitaire



Working with the microwave combination oven

Follow the instructions below:

- Only those persons who satisfy the requirements stipulated in this Safety Guide are permitted to use the microwave combination oven.
- Only use the microwave combination oven for the specified use. Never, under any circumstances, use the microwave combination oven for other purposes.
- Take all the safety precautions specified in this Safety Guide and on the microwave combination oven. In particular, use the prescribed personal protective equipment.
- Only stand in the working positions specified.
- Do not make any changes to the microwave combination oven, e. g. removing parts or fitting un-approved parts. In particular, you must not disable any safety devices.

IMPORTANT SAFETY INSTRUCTIONS

All appliances

When using electrical appliances, basic safety precautions should be followed including the following.

WARNING – To reduce the risk of burns, electric shock, fire, injury to persons, or exposure to excessive microwave energy:

- 1) Read all instructions before using the appliance.
- 2) Read and follow the specific 'PRECAUTIONS TO AVOID POSSIBLE EXPOSURE TO EXCESSIVE MICROWAVE ENERGY' on page 4.
- 3) The appliance must be grounded. Connect only to a properly grounded outlet. See 'Grounding instructions' in Section 1F.
- 4) Install or locate this appliance only in accordance with the provided installation instructions.
- 5) Some products such as whole eggs and sealed containers – for example, closed glass jars – are able to explode and should not be heated in this oven.
- 6) Use this appliance only for its intended use as described in the manual. Do not use corrosive chemicals or vapors in this appliance. This type of oven is specifically designed to heat, cook or toast food. It is not designed for industrial or laboratory use.
- 7) **HOT CONTENTS CAN CAUSE SEVERE BURNS. DO NOT ALLOW CHILDREN TO USE THE MICROWAVE.** Use caution when removing hot items.
- 8) Do not operate this appliance if it has a damaged door, cord or plug, if it is not working properly, or it has been damaged or dropped.
- 9) This appliance should be serviced only by qualified service personnel. Contact nearest authorized service facility for examination, repair, or adjustment.
- 10) Do not block or cover any openings on the appliance.
- 11) Do not store this appliance outdoors. Do not use this product near water, for example, near a kitchen sink, in a wet basement, near a swimming pool, or similar locations.
- 12) Do not immerse cord or plug in water
- 13) Keep cord away from heated surfaces
- 14) Do not let cord hang over edge of table or counter
- 15) When cleaning surfaces of door and oven that come together on closing the door see the instructions on cleaning the door surface in the Operations and Installation Guide – Section 2H.
- 16) To reduce the risk of fire in the oven cavity



- i. Do not overcook food. Carefully attend appliance when paper, plastic, or other combustible materials are placed inside the oven to facilitate cooking.
- ii. Remove wire twist-ties from paper or plastic bags before placing a bag in the oven.
- iii. If materials inside the oven ignite, keep the oven door closed. Turn the oven off, and disconnect the supply cord, or shut off power at the fuse or circuit breaker panel.
- iv. Do not use the cavity for storage purposes. Do not leave paper products, cooking utensils or food in the cavity when not in use.

17) Liquids, such as water, coffee or tea are able to be overheated beyond the boiling point without appearing to be boiling. Visible bubbling or boiling when the container is removed from the microwave combination oven is not always present. THIS COULD RESULT IN VERY HOT LIQUIDS SUDDENLY BOILING OVER WHEN THE CONTAINER IS DISTURBED OR A UTENSIL IS INSERTED INTO THE LIQUID.

Combination microwave ovens

- 1) Oversized foods or oversized metal utensils should not be inserted in a microwave oven as they may create a fire or risk of electric shock.
- 2) Do not clean with metal scouring pads. Pieces can burn off the pad and touch electrical parts involving a risk of electric shock.
- 3) Do not store any materials, other than the manufacturer's recommended accessories in this oven when not in use.
- 4) Do not cover racks or any other part of the oven with metal foil. This will cause overheating of the oven.

SAVE THESE INSTRUCTIONS



CONSIGNES DE SÉCURITÉ IMPORTANTES

Tous les appareils

Lorsque vous utilisez des appareils électriques, des précautions de sécurité de base doivent être observées, notamment.

AVERTISSEMENT – Afin de réduire le risque de brûlures, de choc électrique, d'incendie, de blessure ou d'exposition à un excès d'énergie dégagée par les micro-ondes :

- 1) Lire l'ensemble des instructions avant d'utiliser l'appareil.
- 2) Lire et respecter plus précisément les "PRÉCAUTIONS À PRENDRE POUR ÉVITER TOUTE EXPOSITION POTENTIELLE À UN EXCÈS D'ÉNERGIE DÉGAGÉE PAR LES MICRO-ONDES" en page 5.
- 3) L'appareil doit être mis à la terre. Le raccorder uniquement à une prise secteur correctement mise à la terre. Voir "Instructions de mise à la terre" dans la Section 1F.
- 4) N'installer ou ne positionner cet appareil que dans le respect des instructions d'installation fournies.
- 5) Certains produits tels que les œufs entiers et récipients étanches – par exemple, flacons en verre fermés – sont susceptibles d'exploser et ne doivent pas être chauffés dans ce four.
- 6) N'utiliser cet appareil que pour son usage prévu décrit dans le manuel. Ne pas utiliser de produits chimiques corrosifs ni de vapeurs dans cet appareil. Ce type de four est conçu spécialement pour chauffer, cuire ou griller des aliments. Il n'est pas conçu pour une utilisation industrielle ou pour être utilisé en laboratoire.
- 7) LES CONTENUS TRÈS CHAUDS PEUVENT CAUSER DES BRÛLURES GRAVES. N'AUTORISEZ PAS LES ENFANTS À UTILISER LE FOUR À MICRO-ONDES. Faites preuve de prudence quand vous sortez des aliments très chauds.
- 8) Ne pas utiliser cet appareil si la porte, le cordon ou la fiche est endommagé, s'il ne fonctionne pas correctement, s'il a été endommagé ou a subi une chute.
- 9) Cet appareil ne doit être réparé que par du personnel de service après-vente qualifié. Contacter le site de service après-vente agréé le plus proche pour examen, réparation ou réglage.
- 10) Ne pas obstruer ni couvrir toute ouverture de l'appareil.
- 11) Ne pas entreposer cet appareil à l'extérieur. Ne pas utiliser ce produit près de l'eau, par exemple près d'un évier, dans un sous-sol humide, près d'une piscine ou dans des lieux comparables.
- 12) Ne pas immerger le cordon ni la fiche dans l'eau
- 13) Conserver le cordon à l'écart des surfaces chaudes
- 14) Ne pas laisser le cordon pendre au bord d'une table ou d'un plan de travail
- 15) Lors du nettoyage des surfaces de la porte et du four qui entrent en contact à la fermeture de la porte, voir les instructions de nettoyage de la surface de la porte dans



le Guide d'installation et d'utilisation – Section 2H.

16) Pour réduire le risque d'incendie dans l'enceinte du four

- i. Ne pas cuire excessivement les aliments. Surveiller attentivement l'appareil en cas d'insertion de papier, plastique ou autre matière combustible à l'intérieur du four pour faciliter la cuisson.
- ii. Retirer les liens torsadés des sachets en papier ou en plastique avant de placer un sachet dans le four.
- iii. En cas d'inflammation de matière à l'intérieur du four, maintenir la porte du four fermée. Arrêter le four, débrancher le cordon d'alimentation ou couper l'alimentation au fusible ou disjoncteur du tableau.
- iv. Ne pas utiliser l'enceinte pour l'entreposage. Ne pas laisser de produits en papier, ustensiles de cuisine ou aliments dans l'enceinte hors utilisation.

17) Les liquides tels que l'eau, le café ou le thé peuvent surchauffer au-delà du point d'ébullition sans sembler bouillir. Les bulles ou l'ébullition ne sont pas toujours visibles à l'enlèvement du récipient du four combiné à micro-ondes. CECI PEUT CONDUIRE À CE QUE DES LIQUIDES TRÈS CHAUDS SE METTENT SOUDAIN À BOUILLIR LORS D'UNE PERTURBATION DU RÉCIPIENT OU À L'INSERTION D'UN USTENSILE DANS LE LIQUIDE.

Four combiné à micro-ondes

- 1) Des aliments trop grands ou ustensiles métalliques de grande dimension ne doivent pas être insérés dans un four à micro-ondes car ils risquent de créer un incendie ou un risque de choc électrique.
- 2) Ne pas nettoyer avec des tampons de récurage métalliques. Des morceaux pourraient se détacher du tampon et toucher des pièces électriques, ce qui présenterait un risque de choc électrique.
- 3) Ne pas entreposer de matières autres que les accessoires recommandés par le constructeur dans ce four quand il n'est pas en cours d'utilisation.
- 4) Ne pas recouvrir les clayettes ni toute autre partie du four de feuille métallique. Ceci ferait surchauffer le four.

CONSERVER CES INSTRUCTIONS



Other safety considerations and instructions

General cautions

WARNING

- Installation of the microwave combination oven must comply with all national and regional laws and regulations as well as the local regulations of the relevant utility companies and local authorities along with any other related requirements.
- This appliance is not intended for mobile use, such as in marine or vehicle applications.
- Changes should not be made to the microwave combination oven, e.g. removing parts or fitting unapproved parts. In particular, the safety devices should never be disabled.
- Always keep at hand the *Operations and Installation Guide* for reference and pass it to the new user if the oven changes ownership.

Restrictions on use

- Never use the appliance to heat alcohol, e. g. brandy, rum, etc. Food containing alcohol can more easily catch fire if overheated. Observe caution and do not leave the appliance unattended.
- Never attempt to deep fry in the oven.
- Do not operate the appliance using microwave only or combination function without food or liquid inside the cooking chamber as this may result in overheating and may cause damage.
- The appliance should not be used to dry linen.
- Do not store any materials, other than the manufacturer's recommended accessories in this oven when not in use.

WARNING

- Liquids or other foods must not be heated in sealed containers or jars since they are liable to explode.

WARNING

- When handling hot liquids, foods and containers, care should be taken to avoid scalds and burns.

Instructions for safe use of the appliance

- When handling hot liquids, foods and containers, care should be taken to avoid scalds and burns.
- As with any cooking appliance, care should be taken to avoid combustion of the items within the appliance.
- Only use utensils that are suitable for use in microwave combination ovens.
- Foods must not be heated in completely sealed containers as the build-up of steam may cause them to explode.
- Items should be unwrapped when using convection and combination functions.
- Excess fat should be removed during 'roasting' and before lifting heavy containers from the oven.
- Food with a skin, e. g. potatoes, apples, sausages, etc. should be pierced before heating.
- In the event of glass breaking or shattering within the oven, ensure that food is totally free of glass particles. If in doubt, dispose of any food that was in the oven at the time of the breakage.
- Food in combustible plastic or paper containers should be transferred to a microwave/oven proof container to avoid the possibility of ignition.
- Do not use paper products when appliance is operated in the toaster mode.
- Oversized foods or oversized metal utensils should not be inserted in a microwave/toaster oven as they may create a fire or risk of electric shock.
- Do not cover racks or any other part of the oven with metal foil. This will cause overheating of the oven.
- Switch off the appliance at the end of all the cooking sessions for that day.



- Extra precautions must be taken when heating and handling liquid:

⚠ CAUTION

- When heating liquids using microwave only or combination function, the contents should be stirred prior to heating to help prevent eruptive boiling.
- Only use containers of appropriate size.
- Insert the food containers correctly.
- Always place containers holding liquids or holding food that will liquefy during cooking on shelves that allow a proper view into the container for all users.
- Always take out horizontally any containers holding liquids or holding food that will liquefy during cooking.

⚠ WARNING

- The contents of feeding bottles and baby food jars must be stirred or shaken and the temperature checked before consumption to avoid burns.

Safe operating requirements

⚠ WARNING

- This appliance is not intended for use by persons with reduced physical sensory or mental capabilities or lack of experience and knowledge unless they have been given supervision or instruction concerning use of the appliance in a safe way and understand the hazards involved.
- As with all electrical appliances, it is recommended to have the electrical connections inspected at least once a year.
- **⚠ DANGER** If the supply cord is damaged, it must be replaced by the manufacturer, its service agent or similarly qualified persons in order to avoid a hazard.
- **⚠ DANGER** The appliance must be disconnected from its power supply during maintenance and when replacing parts.
 - Unplug appliance such that from any access point the operator can check the plug remains removed.
 - Use of disconnection with a locking system in the isolated position is recommended in order to avoid a hazard.

⚠ WARNING

If the door or door seals are damaged, the oven must not be operated until it has been repaired by a competent person. See *Section 1E – Requirements to be met by a operating personnel working position*.

⚠ DAMAGE

- The minimum space requirements specified in this guide to install and operate the appliance must be followed. See *Section 1F*.
- Ensure dry floor. The floor adjacent to the appliance may be slippery. Clean up spillages immediately.

Cleaning safely requirements

- Personnel charged with cleaning must be trained regularly by the person responsible for the microwave combination oven.
- The oven should be cleaned regularly and any food deposits removed.
- The oven must already be cool or cooled down following the correct procedures specified in the *Section 2G*.
- Use only cleaning chemicals that have been approved by the manufacturer.
- High-pressure cleaners or water jets must not be used for cleaning.
- The appliance must not be treated with alkali or acid solutions or exposed to acid fumes.
- The cooking chamber of the appliance and the door seals should be cleaned frequently. Failure to maintain the



appliance in a clean condition could lead to deterioration of the surface, which could adversely affect the life of the appliance and possibly result in a hazardous situation. Details for cleaning door seals, cavities and adjacent parts are provided in *Section 2H*.

- Ensure that the cavity has been cleaned thoroughly of any cleaning agents with warm water, then wipe with a soft cloth or paper towel.
- Do not clean with metal scouring pads. Pieces can burn off the pad and touch electrical parts involving a risk of electric shock.
- The air filter (Figure 1.3, item 7) is part of the ventilation system and should be cleaned daily.
- Do not heat up the appliance if there are cleaning chemicals inside.



Full cleaning procedures are detailed in Section 2H.

Emergency instructions

⚠ DANGER

- If smoke is observed, switch off the appliance. Unplug or isolate it from the electrical supply and keep the door closed in order to stifle any flames.



1D.Summary of design, operational hazards and safety devices

The information in this section should be read and understood by Facility Managers, Chefs, Users and Service Technicians.

The microwave combination oven is designed to protect the user from all hazards that can reasonably be avoided by design measures. The actual purpose of the microwave combination oven, however, means that there are still residual risks; you must therefore take precautions to avoid them. A safety device can provide you with a certain degree of protection against some of these hazards. You must ensure, however, that these safety devices are in place and in working order.

Le four combiné à micro-ondes est conçu pour protéger l'utilisateur de tous les risques pouvant raisonnablement être évités à l'aide de dispositions de conception. L'objet même du four combiné à micro-ondes ne peut cependant exclure les risques résiduels ; c'est pourquoi il convient de prendre des précautions pour les éviter. Un dispositif de sécurité peut vous offrir un certain degré de protection contre certains de ces risques. Vous devez cependant vous assurer que ces dispositifs de sécurité sont en place et en état de marche.

Warning and safety signs

The following warning signs/notices must be attached to the microwave combination oven and optional accessories so that they are easily visible at all times. The exact position of the labels may vary slightly depending on the version of the oven that you have purchased. Figure 1.1 highlights the areas with information that a service engineer may require.

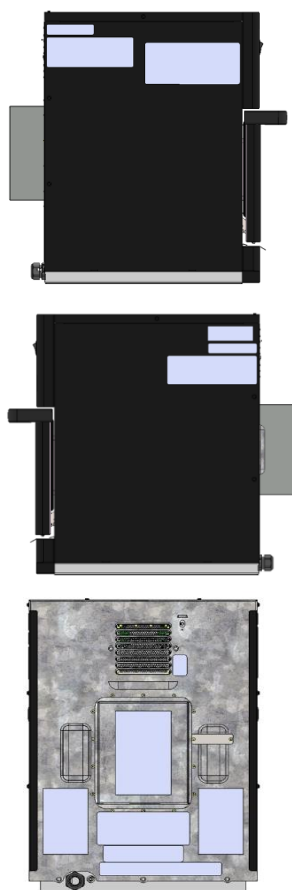

Symbol	Descriptions
	<p>Microwaves warning</p> <p>There is a risk of external and internal burns of body parts following exposure to microwave energy.</p>
	<p>Electric shock warning</p> <p>There is a risk of electric shock if the appliance is serviced without disconnecting the electrical supply.</p>
	<p>Fire / electric shock warning</p> <p>There is a risk of fire / electric shock if the appliance is operated without respecting the minimum clearances.</p>
	<p>Hot surface warning</p> <p>There is a risk of burns from high temperatures inside the cavity and on the inside of the appliance door.</p>
	<p>Electric shock warning</p> <p>There is a risk of electric shock if the electrical power is not connected to a properly grounded outlet.</p>
	<p>Equipotential bonding</p>

Table 1.1: Meaning of signs

Figure 1.2: Warning and safety signs on appliance

Parts and safety devices



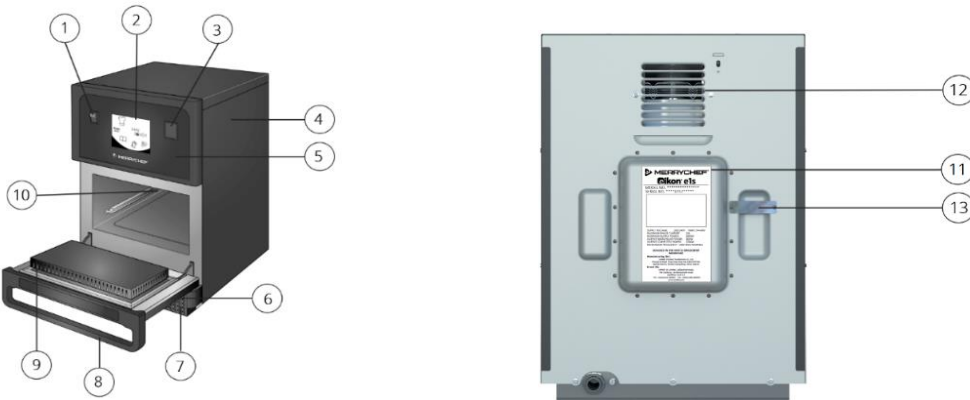

Figure 1.3: e1s front and rear views – parts and safety devices

Item	Part / safety device	Function and precautions
1	ON/OFF appliance switch	Used to turn the microwave combination oven on and off. However, turning this switch off does not isolate the appliance from the electricity supply.
2	easyToUCH® screen control panel	The easyToUCH® screen illuminates to alert the user that the appliance is switched on.
3	USB port	A USB socket located under the cover allows updates to programs stored on the appliance.
4	Protective cover	The cover can only be removed with specific tools. It prevents live parts from being touched accidentally and prevents access to the moving fan. Always ensure the cover is securely in place.
5	Operating panel	Can only be removed using specific tools and prevents live parts from being touched accidentally. Always ensure the panel is in place.
6	Appliance door	Protects the user and outside environment from hot steam and microwave energy. Check the door regularly for damage and replace it if required.
7	Air filter	The air filter is part of the ventilation system and should be free of obstruction and cleaned daily.
8	Door handle	The door handle is a rigid bar which is pulled downwards and away from the appliance to open it.
9	Door seals	The tight seals around the door ensure protection from microwave energy leaking from the cavity. Check the door seals regularly for signs of damage and replace it if required.
10	Cavity	The cavity (cooking chamber) is constructed from stainless steel and used for cooking products. Keep it clean by following the appliance's cleaning procedures.
11	Nameplate	A label that is attached at the rear of the oven and states the serial number, model type and electrical specifications.
12	Air outlets	Air used to cool internal components and allow steam from the cavity to escape. The air outlets must be kept free from obstruction and they will not allow microwave energy to escape into the environment.
13	Steam pipe and cover	A covered pipe from the cavity to the back of the oven to vent steam during cooking and prevent pressure build up.

Table 1.2: Parts – functions and precautions



Other safety devices

Safety device	Functions	Checks / Actions
Door interlocks - Electric door sensor for appliance door	<ul style="list-style-type: none"> Ensures that the microwave generation system cannot be powered when the door is open 	<p>Check door switch:</p> <ul style="list-style-type: none"> Action: Open the appliance door fully and press Start Result: Door open warning message
Disconnection device	<ul style="list-style-type: none"> Installed by the customer close to the appliance; easily visible and accessible, 1- or 3-pole action, minimum contact separation 3mm Used to disconnect the appliance from the power supply during cleaning, repair and servicing work and in case of danger 	<p>Action:</p> <ul style="list-style-type: none"> Trip the disconnection device Unplug appliance such that from any access point the operator can check the plug remains removed Use of disconnection with a locking system in the isolated position
Internal fuses	<ul style="list-style-type: none"> Prevent faulty components from drawing too much current and causing potential fire hazard 	<ul style="list-style-type: none"> Ensure that the internal fuses are correctly rated

Table 1.3: Safety devices - actions and checks



Hazard points

Heat generation (1)

The microwave combination oven becomes hot inside the cavity and on the inside of the appliance door. This poses a risk of burns on hot surfaces inside the microwave combination oven, and also on hot appliance parts, food containers and other accessories used for cooking.

Hot steam / vapor (2)

When cooking food, the microwave combination oven may generate hot steam and vapor which escapes when the appliance door is opened and which is removed through the air vents on the rear of the microwave combination oven when the appliance door is closed. This poses a risk of scalding from hot steam when the appliance door is opened. Take particular care when opening the appliance door if the top door edge is below your field of vision.

Live components (3)

The microwave combination oven contains live parts. This means a risk from live parts if the cover is not in place.

Parts moving against each other (4)

For various actions, such as opening/shutting the appliance door or cleaning the appliance door, there is the risk that you will crush or cut your hand.

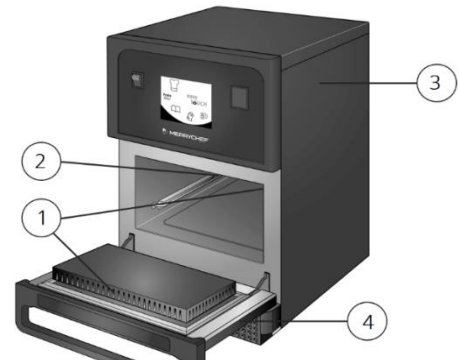

Figure 1.4: Hazard points

Risques

Production de chaleur (1)

Le four combiné à micro-ondes devient chaud dans l'enceinte de cuisson et sur la face intérieure de la porte de l'appareil. Cela pose un risque de brûlure sur les surfaces chaudes à l'intérieur du four combiné à micro-ondes et aussi sur les parties chaudes de l'appareil, les récipients alimentaires et autres accessoires utilisés pour la cuisson.

Vapeur d'eau chaude / fumées (2)

Lors de la cuisson des aliments, le four combiné à micro-ondes peut produire de la vapeur d'eau chaude et des fumées s'échappant lorsque la porte de l'appareil est ouverte et qui sont éliminées par les orifices d'évacuation situés à l'arrière du four combiné à micro-ondes lorsque la porte de l'appareil est fermée. Cela pose un risque de brûlure par vapeur chaude à l'ouverture de la porte de l'appareil. Faire particulièrement attention lors de l'ouverture de la porte de l'appareil si le bord supérieur de la porte se situe en-dessous de votre champ de vision.

Composants sous tension (3)

Le four combiné à micro-ondes contient des pièces sous tension. Cela implique un risque engendré par les pièces sous tension si le capot n'est pas en place.

Pièces mobiles les unes par rapport aux autres (4)

Lors de différentes actions telles que ouvrir/fermer la porte de l'appareil ou nettoyer celle-ci, il existe un risque de s'écraser ou de se couper la main.

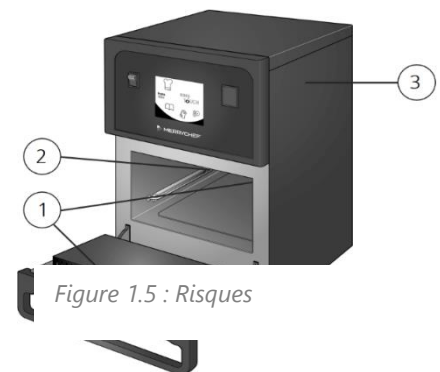

Figure 1.5 : Risques

Intended use of your microwave combination oven

The microwave combination oven must only be used for the purposes specified below:

- The microwave combination oven is designed and built solely for cooking different foodstuffs in containers approved by the manufacturer. Microwave, convection and impingement are used for this purpose.
- The microwave combination oven is intended solely for professional, commercial use.

Restrictions on use

Some materials are not allowed to be heated in the microwave combination oven:

- No dry powder or granulated material.
- No highly flammable objects with a flash point below 270°C / 518°F, such as highly flammable oils, fats or cloths (kitchen cloths).
- No food in sealed tins or jars.

Requirements to be met by personnel

- The microwave combination oven must only be operated and installed by personnel who satisfy specific requirements. Please refer to *Section 1E - Requirements to be met by personnel, working positions* for the training and qualifications requirements.
- Personnel must be aware of the risks and regulations associated with handling heavy loads.

Requirements relating to the operating condition of the microwave combination oven

- Do not operate the microwave combination oven unless it has been properly transported, set up, installed and placed into operation as indicated in this manual and the person responsible for placing it into operation has confirmed this.
- The microwave combination oven must only be operated when all safety devices and protective equipment are fitted, in working order and fixed properly in place.
- The manufacturer's regulations for operation and servicing of the microwave combination oven must be observed.

Requirements relating to the operating environment of the microwave combination oven

Specified operating environment for the microwave combination oven:

- The ambient temperature lies between +4°C / 40°F and +35°C / 95°F
- Not a toxic or potentially explosive atmosphere
- Dry kitchen floor to reduce the risk of accidents

Specified properties of the installation location:

- No fire alarm, no sprinkler system directly above the appliance
- No flammable materials, gases or liquids above, on, under or in the vicinity of the appliance
- It must be possible to set up the microwave combination oven in the installation position so that it cannot tip over or slide about. The supporting surface must comply with these requirements.

Mandatory restrictions on use:

- The appliance must not be operated outdoors and not be shifted or moved during use.

Cleaning requirements

- Use only cleaning chemicals that have been approved by the manufacturer.
- High-pressure cleaners or water jets must not be used for cleaning.
- The appliance must not be treated with alkali or acid solutions or exposed to acid fumes.



1E.Requirements to be met by operating personnel working positions

The information in this section should be read and understood by Facility Managers, Chefs, Users and Service Technicians.

Personnel	Qualifications	Tasks
Facility Manager	<ul style="list-style-type: none"> • Has relevant professional training • Trained in how to operate the microwave combination oven 	<p>Responsible for staff safety. To guarantee safety:</p> <ul style="list-style-type: none"> • Only personnel who demonstrably understand the hazards detailed in this section and strictly follow the precautions and proper usage of instructions provided should be permitted to use the microwave combination oven • Ensure ALL personnel coming in to contact with the microwave combination oven use the Personal Protective Equipment for each task as detailed in this guide
Chef	<ul style="list-style-type: none"> • Has relevant professional training • Knows relevant national food legislation and regulations, plus hygiene legislation and regulations • Must keep records in accordance with Hazard Analysis and Critical Control Points (HACCP) • Trained in how to operate the microwave combination oven 	<p>Essentially performs organizational tasks such as:</p> <ul style="list-style-type: none"> • Entering the cooking profile data • Editing existing cooking profiles in the cookbook • Developing new cooking profiles • Adjusting appliance settings • They may also perform all user tasks if applicable
User	<ul style="list-style-type: none"> • Semi-skilled • Trained in how to operate the microwave combination oven • Works under supervision • Knows the regulations associated with handling heavy loads 	<p>Essentially performs specific operating tasks such as:</p> <ul style="list-style-type: none"> • Loading the microwave combination oven • Starting a cooking profile • Removing food • Cleaning the microwave combination oven. • Fitting accessories in the microwave combination oven • Minor servicing tasks
Equipment mover	<ul style="list-style-type: none"> • Trained in the use of a pallet truck and forklift truck • Knows the regulations associated with handling heavy loads 	<ul style="list-style-type: none"> • Conveying within the establishment
Service technician	<ul style="list-style-type: none"> • Is an authorized service agent • Has relevant technical training • Is trained in the particular appliance • Knows the regulations associated with handling heavy loads 	<ul style="list-style-type: none"> • Setting up the appliance • Preparing the appliance for first-time use and taking the appliance out of service • Instructing the user

Table 1.4: Personnel – qualifications and tasks



1F. Hazards and safety precautions during installation and setting up

The information in this section should be read and understood by Facility Managers, Equipment Movers and Service Technicians.

Personal protective equipment requirement

When installing or moving the appliance, ensure the following personal protective equipment is used:

- Protective gloves
- Safety boots
- Hard hat (e.g. when heavy loads are being lifted and working overhead)

To ensure local and national standards and regulations relating to workplaces in catering kitchens and the installation location are observed, only Service Technicians are permitted to set up the appliance.

Safety precautions relating to the installation location

To prevent hazards that arise from the installation site and environment of the appliances, the following rules must be observed:

- The floor adjacent to the appliance may be slippery. Clean up spillages immediately.
- The location for installation must comply with operating conditions requirements:
 - The ambient temperature lies between +4°C /40°F and +35°C/95°F
 - Not a toxic or potentially explosive atmosphere
 - Dry kitchen floor to reduce the risk of accidents
-  **DAMAGE** Minimum space requirement must be complied with:
 - The minimum height of free space necessary above the top surface of the appliance is 50mm (2").
 - The minimum depth requirement is as follows:
 - Width of appliance = 406.4mm (16")
 - Total depth with door open = 806.9mm (31.8")
 - Counter depth = 499.0mm (19.6")
 - Safety clearance on left-/right-hand side / at rear: 0mm
- The appliance must not be installed directly under a fire alarm or sprinkler system. Fire alarm installations and sprinkler systems must be set up to handle the level of steam and vapor expected to escape from the appliance when the door is opened.
- There is a risk of fire from the heat emitted from hot surfaces. Therefore, flammable materials, gases or liquids must not be located near, on or below the appliance.
- It must be possible to set up the microwave combination oven in the installation position so that it cannot tip over or slide about. The supporting surface must comply with these requirements.
- Vibrations must generally be avoided when using wheeled oven stands or wheeled stacking kits.
- Heat sources in the vicinity must lie at a minimum distance of 500mm (20").



- The appliance must be installed so that there is absolutely no possibility that liquid from the appliance or liquid coming from cooking processes can reach deep-fat fryers or appliances that use hot, uncovered fat. Deep-fat fryers or appliances that use hot, uncovered fat, and which are located in the vicinity must lie at a minimum distance of 500mm / 20in.
- Requirements for supporting surface is met.
 - The supporting surface must be flat and level.
 - The supporting surface must have a non-slip surface.
 - The supporting surface must be able to bear the in-use weight of the appliance, plus the weight of the structure supporting the appliance as follows: 50Hz = 46kg /101lbs and 60Hz = 45kg / 99lbs.

Grounding instructions

⚠WARNING

Improper use of the grounding plug can result in a risk of electric shock and death.

- This appliance must be grounded. In the event of an electrical short circuit, grounding reduces the risk of electric shock by providing an escape wire for the electric current.
- This appliance is equipped with a cord having a grounding wire with a grounding plug.
- The plug must be plugged into an outlet that is properly installed and grounded.
- Consult a qualified electrician or service technician if the grounding instructions are not completely understood, or if doubt exists as to whether the appliance is properly grounded, and do not use an extension cord.
- If the power supply cord is too short, have a qualified electrician or service technician install an outlet near the appliance.

Instructions de mise à la terre

⚠AVERTISSEMENT

Une utilisation incorrecte de la prise de terre peut conduire à un risque de choc électrique et de décès.

- Cet appareil doit être mis à la terre. En cas de court-circuit électrique, la mise à la terre réduit le risque de choc électrique en fournissant un trajet d'évacuation du courant électrique.
- Cet appareil est équipé d'un cordon avec fil de terre et fiche avec terre.
- La fiche doit être branchée sur une prise installée et mise à la terre correctement.
- Contacter un électricien ou un technicien de service qualifié si vous ne comprenez pas parfaitement les instructions de mise à la terre, ou en cas de doute sur la mise à la terre correcte de l'appareil, et ne pas utiliser de rallonge.
- Si le cordon d'alimentation est trop court, faire poser une prise près de l'appareil par un électricien ou un technicien de service qualifié.



Potential risks during installation and setting up

Risk of injury from lifting heavy weights incorrectly

⚠️ WARNING

When lifting the appliance, the weight of the appliance may lead to injuries, especially in the torso area. To avoid this:

- Use a fork-lift truck/pallet truck to move the appliance.
- Use suitable lifting gear.
- When lifting the appliance, use enough people for the weight of the appliance (value depending on age and gender). Observe the local occupational safety regulations for lifting and carrying.

Risk of body parts being crushed when moving and setting the appliance down

⚠️ WARNING

To avoid crushing body parts, ensure these instructions are followed:

- Use suitable handling gear
- Move the appliance slowly and carefully, and secure it against tipping over
- Make sure centre of gravity is balanced and avoid jolts
- Ensure the supporting surface meets the requirements specified above

Risk of cuts from sharp edges

⚠️ CAUTION

To avoid cuts, ensure personal protective equipment is used and exercise caution when handling sheet-metal parts.

Risk of trapping fingers or body in mechanical parts of the appliance

⚠️ WARNING

To avoid this risk, when opening or closing the door, ensure that the handle is used and keep clear of the door hinges.

Risk of electric shock from live electrical parts

⚠️ DANGER

Live electrical parts are to be found under covers, under the operating panel, along the mains power lead and on metal parts adjacent to the appliance. As such, work on the electrical system must only be performed by qualified electricians (as per EN50110-1 in EU or equivalent) from an authorized service company. To avoid risk:

- The appliance must not be installed or operated outdoors.
- The electrical supply must be connected in accordance with applicable local and national regulations and regulations of the professional associations and of the relevant power supply company.
- Ensure that all electrical connections are in perfect condition and fixed securely.
- Make sure that the appliance is connected to an equipotential bonding system (EU).
- If two microwave combination ovens are installed in a stacking kit, both cases of the appliances and the stacking kit itself must be grounded in a suitable manner and connected to an equipotential bonding system.
- For microwave combination ovens on a wheeled platform, the length of the mains power lead must accommodate the degree of movement allowed to the appliance by the retaining device on the wheeled platform. When moving the assembly (platform plus appliance), never place the mains power lead under tension.
- All electrical connections must be checked when the appliance is prepared for first-time use to ensure cables are laid correctly and connections are made properly.



1G.Hazards and safety precautions when preparing appliance for use

The information in this section should be read and understood by Facility Managers, Chefs, Users and Service Technicians.

Personal protective equipment requirement

Ensure work wear as specified in country-specific standards and directives for kitchen work is used, in particular:

- Protective clothing
- Heat protective gloves (compliant with EN 407 in European Union or equivalent)
- Safety boots

Safety precautions for preparation for first use

- Ensure cardboard packaging and transport securing devices etc. have been removed completely from the appliance.
- Ensure that any work on the electrical system is performed solely by a qualified electrician from an authorized service company.
- Ensure that the appliance, including all metallic accessories, is connected to an equipotential bonding system.
- Ensure all warning signs are in their designated position (Figure 1.2).
- Ensure all safety devices and protective equipment are fitted, are working correctly and are secured properly in place.
- Do not operate the microwave combination oven unless it has been properly transported, set up, installed and placed into operation as indicated in this manual and the person responsible for placing it into operation has confirmed this.
- Do not operate the oven if it is damaged. It is particularly important that the oven door closes properly and that there is no damage to the door, door hinges, door seals and sealing surfaces.
- If the appliance has wheels fitted to the supporting structure, the parking brakes on the front wheels must be engaged when operating the appliance.
- Ensure the air filter situated at the lower front of the appliance (Figure 1.3), is free of obstruction.
- Ensure the air outlets (Figure 1.3) are free from obstruction.



For details of ongoing safety precautions for everyday use, see *Section 1H: Hazards and safety precautions during operation*.



1H.Hazards and safety precautions during operation

The information in this section should be read and understood by Facility Managers, Chefs, Users and Service Technicians.

Personal protective equipment requirement

Ensure work wear as specified in country-specific standards and directives for kitchen work is used, in particular:

- Protective clothing
- Heat protective gloves (compliant with EN 407 in European Union or equivalent)
- Safety boots

General rules

- The appliance must not be operated outdoors.
- The appliance must not be shifted or moved during use.
- The appliance must not be operated without the air filter in place.
- The air filter must always be kept free of obstruction.
- The air outlets must be kept free from obstruction.
- Never hang dish towels or cloths on any part of the appliance.
- Never remove the external covers of the appliance.
- Never remove any fixed internal parts of the appliance.
- Never tamper with the control panel, door, seals, or any other part of the appliance.
- If the door or door seal is damaged, the appliance must not be operated until it has been repaired by a Service Technician.
- The door is a precision-made energy barrier with three microwave safety interlocks. Do not use it to support heavy objects.
- If the supply cord is damaged, it must be replaced by the manufacturer, a Service Technician or similarly qualified person to avoid a hazard.



If smoke is observed at any point, switch off the appliance. Unplug or isolate it from the electrical supply and keep the door closed in order to stifle any flames.

Restrictions on use



The restrictions listed in *Section 1D: General safety* must always be complied with.

Instructions for safe use of the appliance



Section 1D: General safety lists instructions for safe use of the appliance.



Potential risks during operation

Hot surfaces



There is a risk of burn if any of the interior parts of the cavity (Figure 1.3, item 11), the inside of the appliance door or any parts that are or have been inside the oven during cooking are touched. Ensure the personal protective equipment detailed at the beginning of this section is used.

Hot steam / vapor



Escaping hot steam and vapor can cause scalding to face and hands. When opening the door and when cooling the cavity using the 'Cool Down' function, step back from the appliance to avoid the hot steam and vapor escaping through the open door.

Excessive microwave energy



Precautions to avoid burns from excessive microwave energy:

- Do not attempt to operate the appliance oven with the door open, since open-door operation can result in harmful exposure to microwave energy. It is important not to defeat or tamper with the safety interlocks.
- Do not place any object between the oven front face and the appliance door or allow soil or cleaner residue to accumulate on sealing surfaces.
- Do not operate the appliance if it is damaged. It is particularly important that the oven door closes properly and that there is no damage to the door, door hinges, door seals and sealing surfaces.
- The oven should not be adjusted or repaired by anyone except properly qualified service personnel.
- This is a Class A product. In a domestic environment this product may cause radio interference in which case the user may be required to take adequate measures.

Radio interference



This is a Class A product. In a domestic environment this product may cause radio interference in which case the user may be required to take adequate measures.

In case of radio or television interference:

- This equipment generates and uses radio frequency energy and if not installed and operated correctly, in strict accordance with the manufacturer's instructions, may cause harmful interference to authorized radio communication services.
- This product complies with the relevant requirements of CFR 47 Ch.1 Part 18, which are designed to provide reasonable protection against such interference. However, there is no guarantee that interference will not occur in a particular installation. If this equipment does cause interference to radio or television reception, which can be determined by turning the equipment off and on, the user is encouraged to try and correct the interference by one or more of the following measures:
 1. Re-orientate the receiving antenna.
 2. Relocate the microwave combination oven with respect to the receiver.
 3. Plug the microwave combination oven into a different outlet so that the receiver and microwave combination oven are on different branch circuits.
- If necessary the user should consult the dealer or an experienced radio/television technician for additional suggestions.



Note: Modifications should only be carried out by the manufacturer or authorized representative to ensure continuing conformance.

Break in the cold chain

⚠️WARNING

To minimize risk of microbiological contamination of foods:

- Never use the appliance for temporary storage of food.
- Never intentionally interrupt the cooking process.
- Once the appliance is running again after a power failure, consider how the length of time taken to resume operation will affect the food condition. If in doubt, discard the food.

Risques potentiels pendant l'utilisation

Surfaces chaudes

⚠️AVERTISSEMENT

Il y a risque de brûlure par contact en touchant toute pièce intérieure de l'enceinte (Figure 1.2, repère 11), l'intérieur de la porte de l'appareil ou toute pièce ayant été à l'intérieur du four pendant la cuisson. S'assurer d'utiliser les équipements de protection individuelle détaillés au début de la présente section.

Vapeur chaude / fumées

⚠️AVERTISSEMENT

Les vapeurs chaudes s'échappant peuvent provoquer des échaudures au visage et aux mains. En ouvrant la porte et en refroidissant l'enceinte par la fonction « cool down », reculer d'un pas de l'appareil pour éviter les vapeurs chaudes qui s'échappent par la porte ouverte.

Énergie micro-ondes excessive

⚠️AVERTISSEMENT

Précautions pour éviter toute énergie micro-ondes excessive :

- Ne pas tenter de faire fonctionner ce four lorsque la porte est ouverte : cela pourrait entraîner une exposition nocive à l'énergie dégagée par les micro-ondes. Il est important de ne pas toucher aux dispositifs de sécurité.
- Ne laisser en aucun cas un objet entre la face avant du four et la porte, et ne jamais laisser des résidus de nourriture ou de produits d'entretien s'accumuler au niveau des surfaces d'étanchéité.
- Ne pas utiliser l'appareil s'il est endommagé. Il est particulièrement important que la porte du four ferme correctement et que les éléments suivants ne soient pas endommagés : porte, charnières, joints de porte et surfaces d'étanchéité.
- Le four doit être réglé ou réparé exclusivement par des techniciens qualifiés.
- Produit de classe A. Dans un environnement domestique, ce produit peut occasionner des interférences radio imposant à l'utilisateur de prendre des mesures adéquates.

Interférences radio

⚠️AVERTISSEMENT

Produit de classe A. Dans un environnement domestique, ce produit peut occasionner des interférences radio imposant à l'utilisateur de prendre des mesures adéquates.

⚠️AVERTISSEMENT

En cas d'interférence avec la radio ou la télévision :



- Cet équipement produit et utilise de l'énergie en fréquence radio et s'il n'est pas installé et utilisé correctement, en respectant strictement les instructions du constructeur, peut causer des interférences nocives aux services de communication radio autorisés.
- Ce produit est conforme aux exigences pertinentes du document CFR 47 Ch.1 Partie 18, conçu pour assurer une protection raisonnable contre de telles interférences. Il n'y a néanmoins aucune garantie que de telles interférences ne surviendront pas dans une installation particulière. Si cet équipement crée des interférences avec la réception de la radio ou de la télévision, ce qui peut être vérifié en éteignant et rallumant l'équipement, l'utilisateur est invité à tenter de corriger l'interférence par une ou plusieurs des mesures suivantes :
 1. Réorienter l'antenne de réception.
 2. Déplacer le four combiné à micro-ondes par rapport au récepteur.
 3. Brancher le four combiné à micro-ondes sur une autre prise de façon que le récepteur et le four combiné à micro-ondes se trouvent sur des circuits électriques différents.
- Si nécessaire, l'utilisateur doit consulter le revendeur ou un technicien expérimenté en radio/télévision pour des suggestions supplémentaires.

Remarque : Les modifications ne doivent être effectuées que par le constructeur ou son représentant agréé pour assurer une conformité permanente.

Rupture de la chaîne du froid

AVERTISSEMENT

Pour réduire le risque de contamination microbiologique des aliments :

- Ne jamais utiliser l'appareil pour entreposer temporairement de la nourriture.
- Ne jamais interrompre intentionnellement la cuisson.
- Lorsque l'appareil fonctionne à nouveau après une coupure de courant, tenir compte du temps nécessaire à la reprise du fonctionnement sur l'état des aliments. En cas de doute, jeter les aliments.



11. Hazards and safety precautions during cleaning

The information in this section should be read and understood by Facility Managers, Chefs, Users and any other personnel charged with cleaning the appliance.

Personal protective equipment requirement

When cleaning the appliance cavity by hand, and using spray cleaning products, the following personal protective equipment should be used:

- Breathing mask
- Safety goggles
- Protective gloves
- Protective clothing/apron

The specification for these items is provided on the data sheet that should accompany the cleaning products themselves or, where necessary, from the manufacturer directly.

Other cleaning tasks should be carried out in accordance with the instructions given on cleaning and with the personal protective equipment specified by the manufacturer of the cleaning products.

General cleaning safety rules and requirements



See *Section 1D: General safety*. Full cleaning procedures are also detailed in *Section 2: Operations and Installation* and the *Service and Repair Guide*.

Potential risks during cleaning

Risk of electric shock from live parts



Water on the exterior of the appliance can cause a short-circuit, which may result in electric shock on touching the appliance. Therefore:

- Do not spray the interior and exterior of the appliance with water.
- Always keep the USB cover closed during cleaning.

Risk of burns from high temperatures on interior parts of the appliance



There is a risk of burns should any of the following be touched:

- Any of the interior parts of the cavity.
- The inside of the appliance door.
- Any parts that are or have been inside the oven during cooking including racks, shelf grills and baking trays.

To minimize the risk of burns:

- Before starting cleaning tasks, wait until the cavity has cooled to below 50°C / 122°F or use the 'Cool Down' function to cool the cavity as described in *Section 2G: Cool down*.



Risk of scalding from hot steam

⚠️ WARNING

If water or cleaning agent is sprayed into the hot cavity, steam will be produced and this may scald. To minimize this risk:

- Before starting cleaning tasks, wait until the cavity has cooled to below 50°C / 122°F or use the 'Cool Down' function to cool the cavity as described in *Section 2G: Cool down procedures*.
- Step back from the appliance to avoid the hot steam and vapor escaping through the open appliance door.

Risk of irritation to skin, eyes and respiratory system from cleaning products

⚠️ WARNING

Direct contact with the cleaning or protective chemicals will irritate the skin, eyes and respiratory system. To minimize this risk:

- Do not inhale the vapors or spray mist from the cleaning and protective chemicals.
- Do not let the cleaning or protective chemicals come into contact with skin, eyes or mucous membranes.
- Do not spray cleaning or protective chemicals into a cavity.
- Wear personal protective equipment as detailed at the beginning of this section.



Wearing personal protective clothing is vital throughout the cleaning process and can minimize risks of burns and scalds.



1J. Hazards and safety precautions during servicing and repair

The information in this section should be read and understood by Service Technicians.

Personal Protective Equipment

When repairing or servicing the appliance, ensure work wear and personal protective equipment is used as specified in applicable national regulations. The following personal protective equipment should be used:

- Protective gloves
- Safety boots
- Hard hat (e.g. when heavy loads are being lifted and working overhead)

Potential risks to move appliance

The potential risks associated with service and repair is the same as the possible risks you can be faced with during installation, as both processes may involve lifting and moving the appliance.

The risks are summarized below:

- Electric shock from live electrical parts
- Injury from lifting incorrectly
- Trapping fingers or body in mechanical parts of the appliance
- Cuts from sharp edges
- Crushing if the appliance tips over or falls off



Further information on the above risks and the procedures to avoid them are detailed in *Section 1F. Hazards and safety precautions during installation and setting up.*

Rules for moving and setting up the wheeled trolley safely

The appliance may need to be moved for service and repair. To avoid hazards, the following rules must be observed when moving the wheeled trolley (optional accessory) that carries the appliances:

- Watch out for all connecting cables when moving appliances. Never wheel over the connecting cables. Never pull off or even stretch the connecting cables.
- The appliances must be disconnected from the electrical supply before moving the stacking kit (optional accessory).
- The appliances must be left to cool down on the trolley before being moved.
- There must not be any food left in the appliances.
- The appliance door must be closed.
- Protective clothing must be worn if the appliance is mounted on a trolley.
- It is important to ensure that the unit is level once it is back in place.
- Once the unit is back in place, the parking brakes must be engaged again.
- Whatever the position, care must be taken to ensure that the trolley carrying the appliance does not tip over.



Risk of burns

WARNING

Before starting servicing and repair work, wait until the cooking chamber has cooled to below 50°C / 122°F or use the 'Cool-Down' function (*Section 2H: Cleaning Procedures*) to cool the cooking chamber.

Wear personal protective equipment suitable for handling hot surfaces before touching any of the interior parts of the cooking chamber, the inside of the appliance door or any parts that were inside the oven during cooking.

Risk of burns from microwave emissions

- Do not become exposed to emissions from the microwave generator or parts conducting microwave energy.
- Never operate an appliance that has failed the 'Microwave Leakage test'.

Risk of smoke or fire

If one of the electrical components is defective, for example due to a short-circuit, or if the internal wiring is refitted incorrectly when servicing/repairing the oven, there is a risk of smoke or fire. To avoid this risk:

- Never use electrical spare components which failed a dedicated test or look damaged.
- Carefully refit electrical connections using the wiring diagrams provided in this guide.



1K. Hazards and safety precautions when taking the appliance out of service

The information in this section should be read and understood by Facility Managers and Service Technicians or other suitably qualified service engineer.

Personal protective equipment

When disconnecting the appliance, ensure work wear and personal protective equipment is used as specified in applicable national regulations.

When moving the appliance, ensure the following personal protective equipment is used:

- Protective gloves
- Safety boots
- Hard hat (e.g. when heavy loads are being lifted working overhead)

General precautions

- The kitchen floor must always be kept dry to reduce the risk of accidents
- The appliance door of the microwave combination oven must be closed before disposing of the appliance
- Do not leave food in the cavity

Potential risks

Risk of electric shock from live parts and loose cables



When the safety cover is open, there is a risk of electric shock from touching live parts. Make sure that any work on the electrical system is performed solely by a qualified electrician from an authorized service company.

Risk of injury from lifting incorrectly



Risks associated with lifting incorrectly and how to avoid injuries are detailed in *Section 1F: Hazard and Safety Precautions during installation and setting up*.

Risk of crushing if the appliance tips over or falls off



See *Section 1F: Hazard and safety precautions during installation and setting up* for details on minimizing risks associated with the appliance tipping over.



Section 2: Operations and Installation



2A.Introduction to e1s

The Merrychef eikon e1s microwave combination oven offers you the flexibility of combination cooking with additional control over fan speed and microwave power.

Combination cooking enables high quality results to be achieved in a fraction of the time taken by conventional cooking, particularly when baking, browning, roasting and grilling dishes.

Once established, precise instructions for combination or convection cooking of selected items may be programmed into the oven's memory so that they can be repeated easily and accurately. Up to 1024 programs can be stored and simply recalled.

The oven controls offer even greater flexibility by allowing multistage programming. This enables the exact conditions required for quality results to be set according to the food type. A single cooking program can have up to six stages, each stage controlled with its own time, fan speed and microwave power settings.



Figure 2.1: e1s oven front view

Identifying your microwave combination oven

A nameplate is located on the rear of the microwave combination oven and contains information on the make, model, serial number, regulations, electricity and power supply and the manufacturing site.

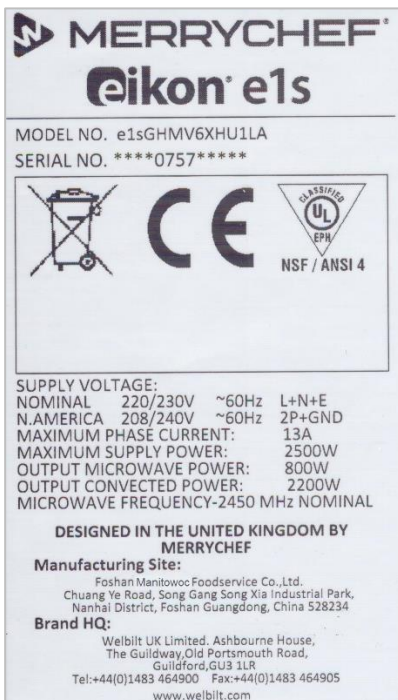

Figure 2.2: e1s name plate



See Section 1B for more details on the information included on the nameplate.

Appliance parts and their functions



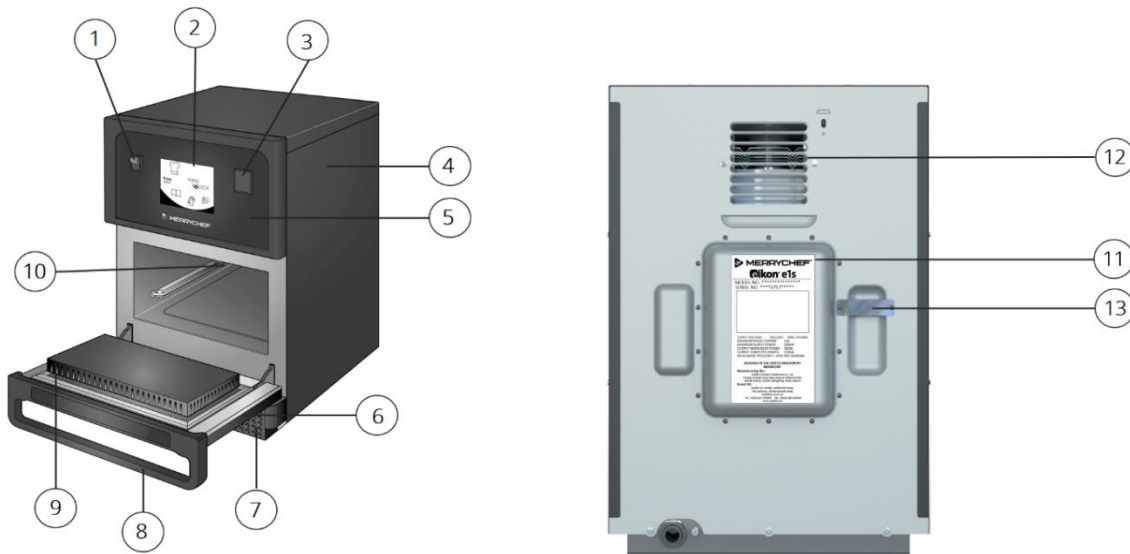

Figure 2.3: Appliance parts and their functions

- 1) **ON/OFF appliance switch** – Used to turn the microwave combination oven on and off. Turning this switch off does not isolate the appliance from the electricity supply.
- 2) **easyTouch® screen control panel** – When the appliance is switched on, the easyTouch® screen illuminates the user interface.
- 3) **USB port** – A USB socket located under the cover allows updates to programs stored on the appliance.
- 4) **Protective cover** – The cover can only be removed with specific tools. It prevents live parts from being touched accidentally and prevents access to the moving fan. Always ensure the cover is securely in place.
- 5) **Operating panel** – Prevents live parts from being touched accidentally. Always ensure the panel is in place.
- 6) **Appliance door** – This is a precision-made energy barrier with three microwave safety interlocks. Always keep it clean and do not use it to support heavy objects.
- 7) **Air filter** – Situated at the lower front of the appliance, the air filter is part of the ventilation system. Keep it free of obstruction and clean it daily as described under *Section 2G: Cleaning procedures*.
- 8) **Door handle** – A rigid bar which is pulled downwards and away from the appliance to open it.
- 9) **Door seals** – Ensure a tight seal around the door. Always keep them clean and check regularly for signs of damage.
- 10) **Cavity** – Also known as the cooking chamber, the cavity is constructed from stainless steel and used for cooking products.
- 11) **Nameplate** – A plate on the rear of the oven that states the serial number, model type and electrical specifications.
- 12) **Air outlets** - On the rear and are used to cool internal components and allow steam from the cavity to escape. The air outlets must be kept free from obstruction and they will not allow microwave energy to escape into the environment.
- 13) **Steam pipe and cover** – A covered pipe from the cavity to the back of the oven to vent steam during cooking and prevent pressure build up.



Equipment and accessories supplied

The e1s microwave combination oven is supplied with the following equipment and accessories.

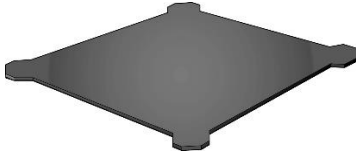

Cook plate

The cook plate sits inside the appliance and food is placed on top of it using suitable liners or baskets. It is removable for cleaning.

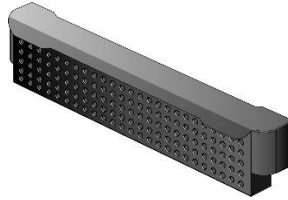

Air filter

The air filter situated at the lower front of the appliance is part of the ventilation system and should be kept clean and free of obstruction.

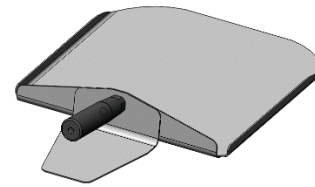

Paddle

The paddle is used to remove food from the oven.



There are a number of other optional Merrychef accessories that customers can purchase to use with the microwave combination oven. Contact Merrychef suppliers for more information.

2B. Installing the appliance



Users must read *Sections 1A to 1K (Safety Guide)* before installing or using the microwave oven.

Unpacking

1. Cut the box banding straps and remove the lid.

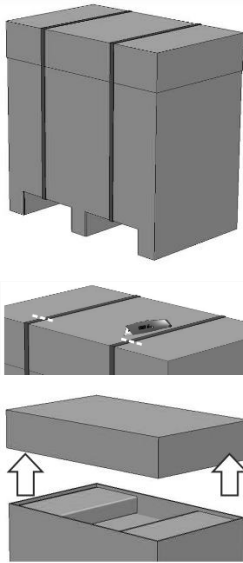

2. Remove the customer documentation and any product accessories:

- 1x air filter
- 1x cook plate
- 1x Operations and Installation Guide

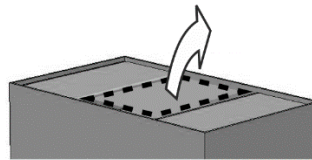

3. Remove the packaging to reveal your microwave combination oven.

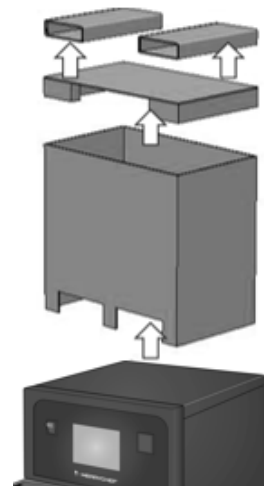

Inspect the appliance for damage before signing the delivery note. Record any damage on the delivery note and notify the carrier and manufacturer.



WARNING Never install or put into service a damaged appliance under any circumstances.

Taking the appliance off the pallet

1. Identify appropriate lifting points.



- Wear appropriate Personal Protective Equipment.
- **Do not lift the oven by the handle.**
- Risk of crushing from the appliance tipping over. Take precautions.

2. Lift the appliance from the packaging. The appliance is now ready for installation.

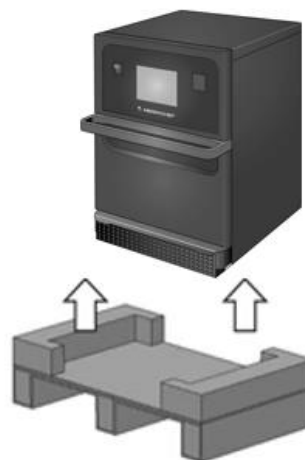

Installation location requirements

Minimum space required

Figure 2.4 shows the space required to install the appliance. It also shows the minimum horizontal distances from adjacent walls and surfaces. The safety clearance on the top must also always be complied with.

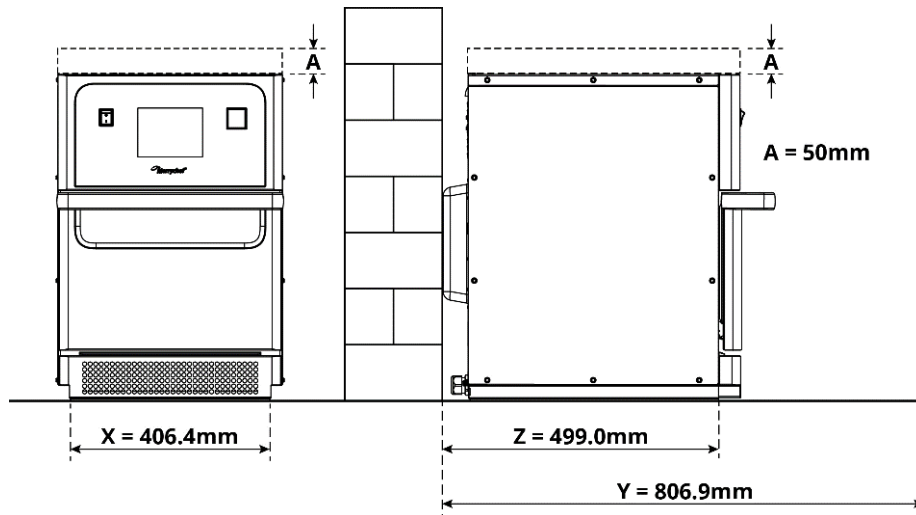

Figure 2.4: Minimum space requirements

- Safety clearance from the top (A) = 50mm (2")
- Depth requirement:
 - Width of appliance (X) = 406.4mm (16")
 - Total depth with door open (Y) = 806.9mm (31.8")
 - Counter depth (Z) = 499.0mm (19.6")
- Safety clearance on left-/right-hand side / at rear: 0mm

Actual space requirements

Far more room than the specified minimum space requirement is needed in front of the appliances to operate the microwave combination ovens safely, in particular to handle hot food safely. Larger wall gaps are generally recommended to provide access for servicing.

In the installation location, the following parts must not be covered, adjusted or blocked:

- Air vent on the rear of the appliance
- Air filter at the front of the appliance

Mounting the appliance on a work surface

The appliance can be mounted on a suitable work surface that can bear the weight.

Observe the following rules to ensure that the appliance is installed in a stable situation:

- The worktop must have a non-slip surface.
- The supporting surface must have the following properties:
 - The supporting surface must be flat and level.
 - The supporting surface must be able to bear the in-use weight of the appliance, plus the weight of the structure supporting the appliance as follows: 50Hz = 46kg /101lbs and 60Hz = 45kg / 99lbs.



Electrical installation requirements

Safety rules



Observe the following rules to prevent hazards caused by faulty electrical connections:

- Only electricians qualified under the terms of EN 50110-1 and from an authorized service company are permitted to perform work on electrical equipment.
- The electrical supply must be connected in accordance with applicable local regulations of the professional associations and of the relevant power supply company.
- The case of the appliance must be grounded in a suitable manner and connected to an equipotential bonding system.
- If two microwave combination ovens are installed in a stacking kit, both cases of the appliances and the stacking kit itself must be grounded in a suitable manner and connected to an equipotential bonding system.
- Wear the personal protective equipment as specified in the *Section 1F*.

Grounding instructions



The appliance must be grounded. Connect only to a properly grounded outlet. See 'Grounding instructions' in Section 1F.

Equipment provided by customer and electrical installation regulations

Table 2.1 shows what equipment must be provided by the customer and what regulations must be observed when connecting the appliance.

Equipment	Regulations
Fuse	Fuse protection and connection of the appliance must comply with local regulations and national installation requirements.
Equipotential bonding	The appliance must be incorporated in an equipotential bonding system. Equipotential bonding: electrical connection that ensures that the frames of electrical equipment and any external conductive components are at an equal (or practically equal) potential.
Residual-current device (RCD)	The installation regulations require protection by a residual-current device (RCD). Suitable residual-current devices meeting the relevant national regulations must be used. If the installation includes more than one appliance, one residual-current device must be provided for each appliance.
Disconnection device	An easily accessible all-pole disconnection device with a minimum contact separation of 3mm must be installed close to the appliance. The appliance must be connected via this disconnection device. The disconnection device is used to disconnect the appliance from the electrical supply for cleaning, repair and installation work.

Table 2.1: Electrical equipment and regulations

The requirements and specifications for e1s

Fitted frequency converter

- The appliance is fitted with one frequency converter (FC) and an EMC mains input filter.
- These devices may result in a leakage current of more than 3.5mA per FC drive.
- Use a suitable RCD for the rated voltage.

Properties of the residual-current device

The residual-current device (RCD) must have the following properties:

- Filter for filtering out RF currents.



- 'Time delayed' trip characteristic for RCD devices with trip threshold >30mA: prevents RCD being tripped by charging currents of capacitors and parasitic capacitances when appliance is switched on.
- 'Leakage current protection, Type SI' trip characteristic for RCD devices with trip threshold >30mA: insensitive to nuisance tripping.

Circuit Breakers

- Establishments with standard (Type 'B') circuit breakers are sensitive to 'surges' which occur on switching on freezers, refrigerators and other catering equipment, including microwave combination ovens. Because of this, a Type 'D' circuit breaker (designed specifically for this type of equipment) must be fitted. An individual, suitably rated circuit breaker should be fitted for each appliance installed.

Low impedance electrical supply

- This commercial combination microwave oven complies with EN 61000-3-11. However, when connecting sensitive equipment to the same supply as the appliance, the user should determine in consultation with the supply authority, if necessary, that a low impedance supply is used.

Electrical supply

- The e1s microwave combination oven is only available as a single-phase model and is designed to draw 13 amps maximum in all configurations, as shown in Table 2.2.

Illustration	Meaning
<p style="text-align: center;">UK / EU</p>	<p>Phase: Single</p> <p>16 A Breaker for 15/16 A plug configurations and be Time Delay, Motor Start Type (European Type D).</p> <p>UK 13 A models are fitted with a moulded plug to BS1363, fused at 13A. EU13 A models are fitted with a moulded plug to CEE 7/7 (Type F Schuko) rated at 16 A.</p> <p>ROW 13 A models are fitted with country specific 15/16 A plugs.</p> <p>Please contact your local Welbilt representative for further information.</p>
<p style="text-align: center;">Latin / South America</p>	
<p style="text-align: center;">China</p>	

Table 2.2: e1s electrical specifications

Equipotential bonding

- An equipotential bonding point is provided on the rear panel of the appliance for independent Earth (GND) connection.



2C. Getting started



Before turning on the oven, users must read *Section 1E: Hazards and safety precautions when preparing appliance for use.*

Fitting the air filter

The air filter is fitted in position below the cavity door. It is a magnetic attachment.

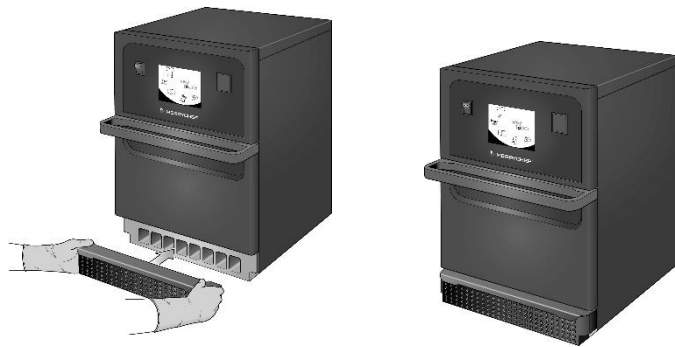

Inserting the cook plate

The cook plate is inserted in the cavity, simply by sliding it onto the shelf runners.

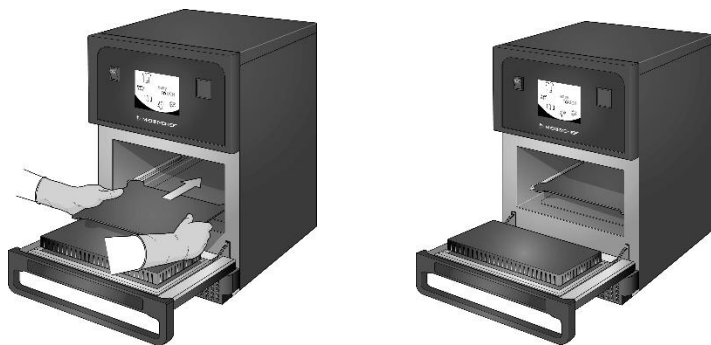

Turning the oven on and off

To start up the oven, ensure the appliance is clean and empty with just the cook plate inside it. Then switch the appliance on using the on/off switch at the front of the oven.

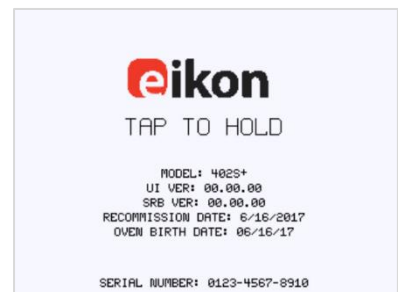

When the oven is switched on, the easyTouch® screen illuminates with the display briefly showing the serial number and appliance data. To keep the data on the screen, lightly tap the screen to freeze the display. Tap again to continue.



Settings on first usage

The system is preconfigured with all the required settings to start cooking immediately following installation. However, you may want to configure the following before using the oven.

- Date and time
- Alarms
- Temperature
- Oven time

Settings are changed by selecting the 'settings' screen which is accessible from the main menu.

However, the main menu is only displayed after the oven is pre-heated and therefore, if you want to change settings before or whilst the oven is heating, for example before first usage, do as follows:

- 1) Tap to hold the first screen upon switching on, which shows the serial number.
- 2) Press the hidden button at the top right-hand corner to load the password screen.



- 3) Enter the administration password. The default password is 'MANAGER'.
- 4) Select the required settings icon to make changes as required.

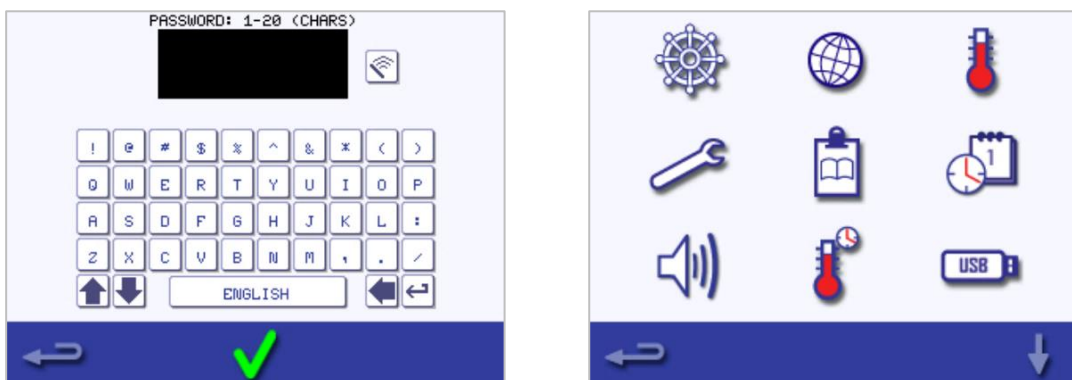

See Section 2F: Changing settings for instructions.



Selecting suitable utensils

You may want to ensure you have suitable utensils before using the oven. Only use utensils that are suitable for use in microwave combination ovens. Check the manufacturer's instructions and temperature rating to determine the suitability of individual containers or utensils.

Table 2.3 provides general guidelines:

Cooking utensils	Permitted	Notice
Heat resistant containers		
Toughened glass	YES	
Compatible vitreous ceramics	YES	Do not use items with metallic decoration
Earthenware (porcelain, crockery and china)	YES	
Metals, foils and plastics		
Metallic and foil trays and containers	NO	
Dual-ovenable plastic containers	YES	Use only containers approved by the manufacturer
Disposables		
Combustibles (paper, card, etc.)	YES	Use only combustibles approved by the manufacturer
Other utensils		
Tie tags	NO	
Cutlery	NO	Do not leave utensils in a food product while it is cooking
Temperature probes	NO	

Table 2.3: Suitable utensils

Preheating the oven

The oven will automatically preheat to the set temperature when it is switched on. However, if the appliance is set up with two or more preheating temperatures, a choice is displayed when the oven is switched on. Select the required temperature.



You may see a scroll arrow at the bottom of the screen which indicates that there are more temperature choices.

During preheating, the display shows the progress as the cavity heats up to the set temperature. To stop the cavity heating up, touch the red 'X' symbol at the bottom of the screen.

The appliance is ready to use when either the cookbook or main menu is displayed.

If the cookbook is displayed, press the Backspace button in the bottom left-hand corner of the screen to display the main menu.

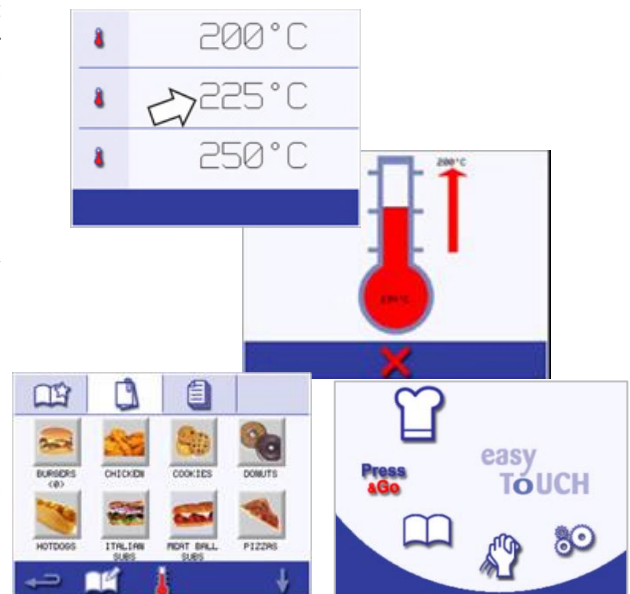

Understanding the main menu and keyboard



Main menu



Keyboard



The easyTouch® screen display, layout and icons shown herein are for guidance purposes only and are not intended to be an exact representation of those supplied with the appliance.

Button	Meaning	Function
Main menu		
	Development Mode	'Development Mode' enables multistage cooking profiles to be developed, then stored under a name and symbol for reuse.
	Press&Go	'Press&Go' allows quick access to use the cooking profiles that are already stored.
	Cookbook	'Cookbook' contains the cooking profiles stored in the memory of the appliance.
	Cleaning / Temp change	'Cleaning / Temp change' allows the cavity temperature to be changed and the appliance to be prepared for cleaning.
	Settings	'Settings' are used to control the appliance settings and functions and for service and maintenance purposes.
Keyboard		
	Keyboard screen	The 'keyboard screen' is used to enter password and to insert data for programs.
	Clear screen	Select the 'clear screen' key to delete text from the keyboard screen.
	Keyboard	Use the 'keyboard' to type in text.
	Spacebar	Select the 'spacebar' key to insert a blank.
	Return	Select the 'return' key to start a new line.
	Keyboard scroll	Select the up/down arrows to scroll the keyboard screen.
	Enter / OK	Select the green checkmark to confirm settings and continue.
	Previous screen	Select the 'backspace' key to return to a previous screen.

Table 2.4: Main menu and keyboard items

Character length

- Use 1-20 characters in two lines max for names of cooking profiles, cooking profile groups and passwords.
- Use 1-54 characters in five lines max for stage instructions of individual cooking profiles.



2D. Cooking procedures

How to cook



1. On a preheated oven, select a cooking profile from the cookbook or enter a new cooking profile.
See Section 2E for instructions on how to enter a new cooking profile.



2. Open the appliance door and place the prepared food on the cook plate.
⚠️ WARNING Hot surface
Ensure all packaging has been removed.



3. Close the appliance door again.
The cooking process will automatically start if the program was selected in step 1. Alternatively, the program can be selected or changed at this stage.



4. Wait for the cooking process to finish. An audible signal is given when the cooking process is finished. Follow the prompts displayed by the software.
Do not open the oven door while the food is cooking.

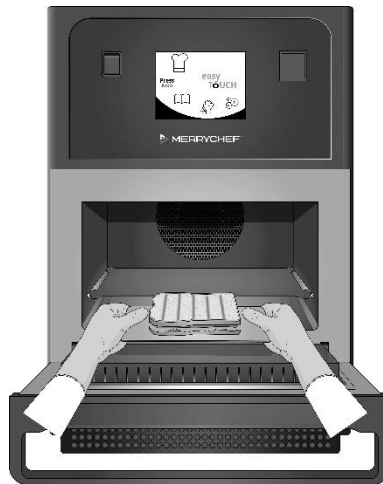

5. Open the appliance door and take the food out.
⚠️ WARNING Hot surface
Do not remove cook plate unless cleaning.
Never leave food in the oven, as it will continue cooking.



6. Close the appliance door again after taking the food out.
The cooking program is reset now and a new cooking profile can be selected to use the oven again.

Using a cooking profile – quick serve mode

1. Select the 'cookbook' symbol  from the main menu screen and then select the All Menus option.



2. Use the scroll up/down arrows to find the cooking profile.

Note: If a picture has a red frame around it, this means the cavity temperature is set too high or too low for that cooking profile. The cavity temperature will need to be changed to use that option. See Changing cavity temperature.



3. Select the required cooking profile to start cooking. For example: 'ITALIAN SUB x 1'.



4. Follow any instructions on the screen, if displayed, and press the green checkmark to start the cooking process.

Note: If food has not been placed in the oven, at this stage open the oven door and place it on the cook plate and then press the green checkmark.

⚠ WARNING Hot surfaces at the door and in the cavity.



5. The cooking time counts down for each stage. When the cooking profile ends, a red bar is displayed usually with an audible sound. Open the door or touch the red 'X' to return to the cooking profile.

Note:

- Opening the appliance door during cooking stops the cooking profile and displays a warning. Avoid opening the door during the cooking process.
- Closing the door, however, allows the user to continue or cancel the cooking profile.



Using a cooking profile – full serve mode

6. Select the 'cookbook' symbol  from the main menu screen and then select a group of cooking profiles, for example 'ITALIAN SUBS', to display the individual cooking profiles.

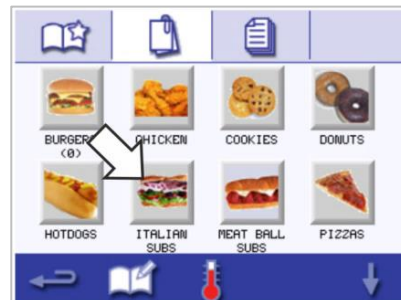

7. Select a cooking profile from the options available in the selected group, for example 'ITALIAN SUB x 2'.



8. Follow any instructions on the screen, if displayed.
Press the green checkmark to start the cooking process.

Note: If the product has not been placed in the oven, at this stage open the oven door and place the food on the cook plate and then press the green checkmark to start cooking.

⚠WARNING Hot surfaces at the door and in the cavity.

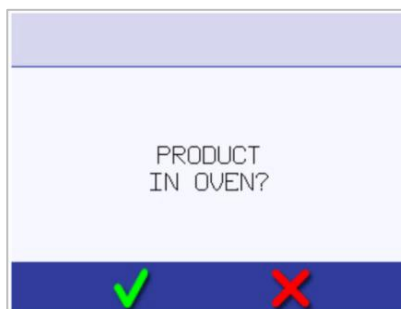

9. The cooking time counts down for each program stage.
When the cooking profile ends, a red bar is displayed usually with an audible sound. Open the door or touch the red 'X' to return to the cooking profile.

⚠WARNING Hot surfaces at the door and in the cavity.

Note:

- To check the cavity temperature when cooking, lightly tap the temperature displayed. The cavity temperature is shown with an asterisk.
- Opening the appliance door during cooking stops the cooking profile and displays a warning. Avoid opening the door during the cooking process.
- Closing the door, however, allows the user to continue or cancel the cooking profile.

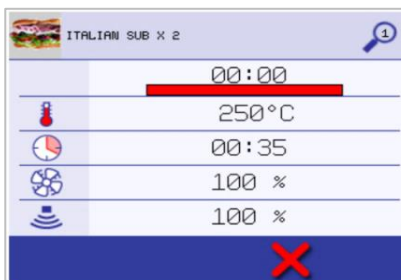

Choosing cooking profiles for Press&Go menu

1. Select 'Press&Go'  from the main menu screen, and then select the 'edit cookbook' symbol.

Two lists are displayed.

- The list on the left shows the cooking profiles that are part of the 'Press&Go' menu.
- The list on the right shows other cooking profiles that are available.



Both lists can be scrolled up or down using the blue arrows on the right of each list.

2. Select a cooking profile from the list on the left.
 - Choose whether to change its position within the list or to remove it into the list on the right.
 - To change the order of cooking profiles in the left list, use the blue up/down arrows in the middle.
 - To move a selected cooking profile to or from the 'Press&Go' menu, use the green/red arrows in the middle.
 - To make a cooking profile from the right list available in the 'Press&Go' menu, move it into the left list.

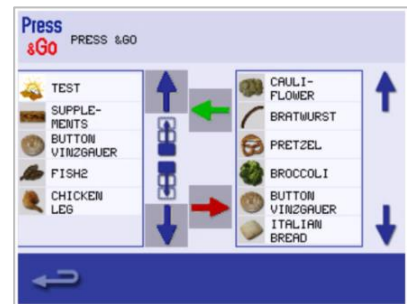

3. Select backspace to return to the 'Press&Go' menu screen when finished.

Running a cooking profile from the Press&Go menu

4. Select 'Press&Go'  from the main menu screen and then select the cooking profile required to cook.

Note: Follow any instructions on the screen, if displayed. If the product has not been placed in the oven, at this stage open the oven door and place the food on the cook plate and then press the green checkmark to start cooking.



5. The display shows the cooking time countdown. The timer bar turns red to indicate that the cooking cycle has finished.



Changing the cavity temperature

You may need to change the cavity temperature depending on the food you are cooking. If the cavity temperature is set to



a value unsuitable for a cooking profile, it will need to be changed before that cooking profile can be used. Cooking profiles unsuitable for the set temperature are highlighted with a red border.

To change the cavity temperature:

1. Take note of the cavity temperature required for the cooking profile and then press the green checkmark to continue.

Note: You can find out the required temperature by selecting a cooking profile highlighted with red border.



2. Select the 'temperature' symbol in the selected cooking profile screen.



3. An asterisk next to the temperature value indicates the present cavity temperature. Select the required cavity temperature for the cooking profile.



2E. Cooking profiles

Creating a cooking profile

1. Enter development mode

Select the 'chef's hat' symbol from the main menu screen to enter development mode.



2. Set the microwave power

The temperature value displays the set preheating temperature. To change the temperature, select the 'temperature' symbol, and enter a value within the limits displayed.

Select the green checkmark to continue.

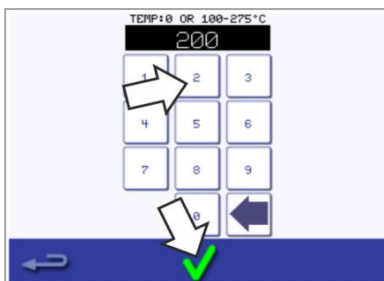

3. Set the cooking time

Select the 'clock' symbol and enter the cooking time for each stage up to a maximum of 10 minutes.

Example: Enter 110 = 1 minute and 10 seconds.

Select the green checkmark to save the inserted value.

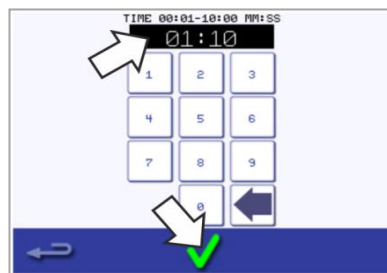
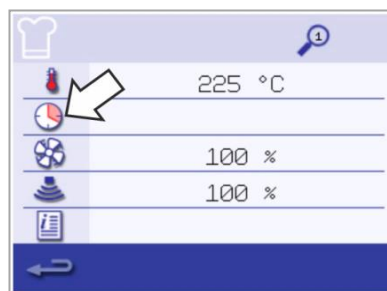

4. Set the microwave power

Select the 'microwave' symbol and set the microwave power (0 and 5-100%).

Select the green checkmark to save the inserted value.

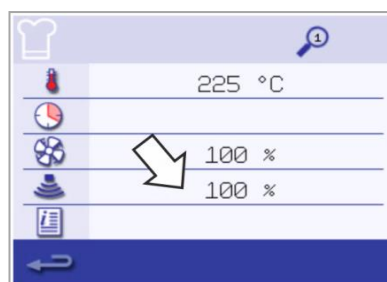

5. Set the fan speed

Select the 'fan' symbol and set the fan speed within the limits shown on the screen.

Select the green checkmark to save the inserted value.

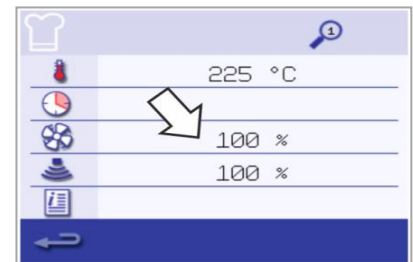

6. Enter instruction for a stage (optional)

Select the 'information' symbol to enter instruction for a stage. *Example: 'Stage 1 - place a food product into the cavity'.*

Select the green checkmark to save the inserted instruction.

Select the right arrow with a 'plus' symbol at the bottom to add a new stage by repeating the steps above.



Note:

- Cooking profiles can have up to a maximum of six stages.
- The 'magnifier' symbol at the top indicates which stage is displayed.
- Select the left/right arrow at the bottom to shift between the stages.



Viewing and editing cooking profiles

1. Select the 'cookbook' symbol from the main menu screen.
2. Select the 'All menus' symbol from the cookbook screen.
3. Select the 'edit cookbook' symbol.

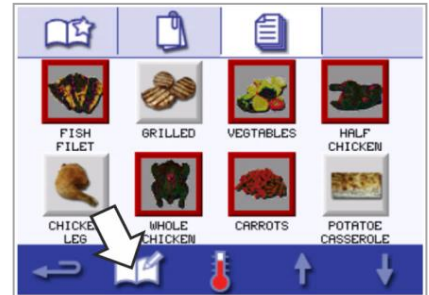
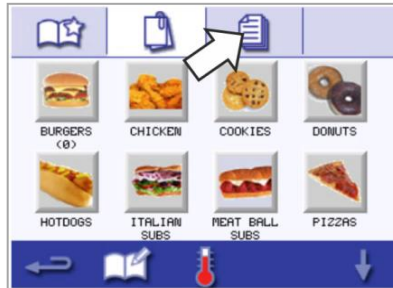

4. Use the up/down scroll arrows to find the cooking profile.
5. Select the 'view/edit cooking profile' symbol.
6. View or adjust the cooking profile as required.

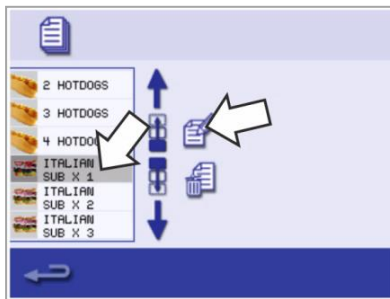
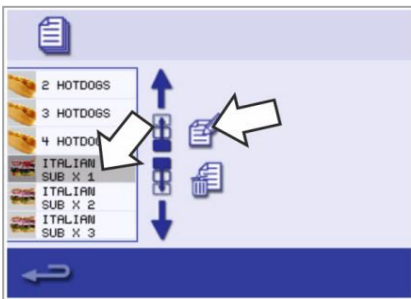

See *Creating Cooking Profile* for instructions on how to change cooking profile entries.

Moving a cooking profile in a group of cooking profiles

1. Select the 'cookbook' symbol from the main menu and select the group of cooking profile to move, e.g. 'ITALIAN SUBS'.
2. Select the 'edit cookbook' symbol in the selected cooking profile screen.
3. Select the cooking profile to move and use the smaller up/down arrows to move it within the group.

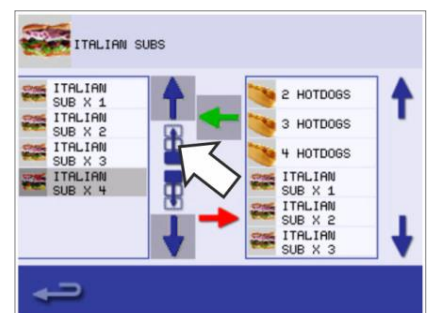

Moving a cooking profile in a list

1. Select the 'cookbook' symbol from the main menu screen and then select the 'edit cookbook' symbol in the cookbook screen.

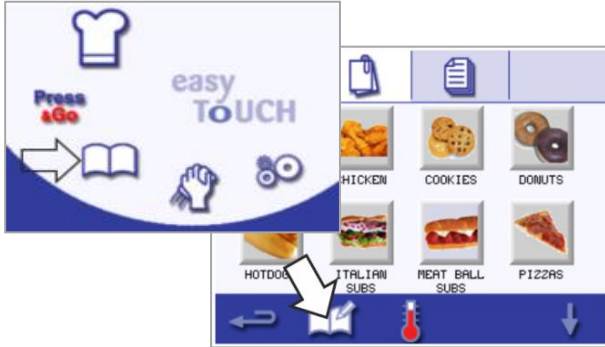

2. Use the big scroll arrows to locate cooking profile groups and then use the small arrows in the centre of the screen to move the selected cooking profile within the list. Use backspace to return to the cookbook screen.

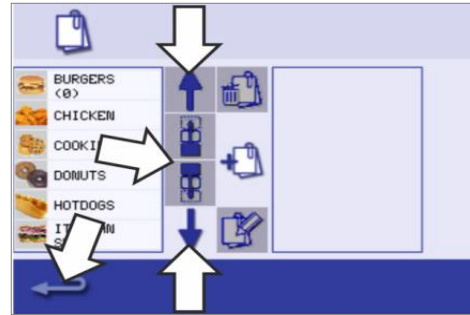

Adding a new cooking profile group

1. Select 'cookbook' from the main menu screen.
2. Select the 'edit cookbook' symbol from the cookbook screen.
3. Select the 'add a new cooking profile group' symbol.

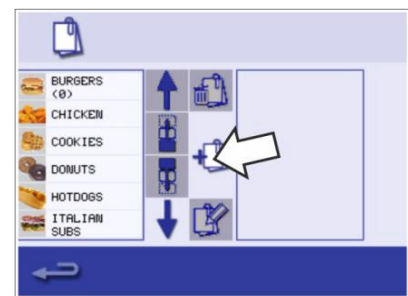
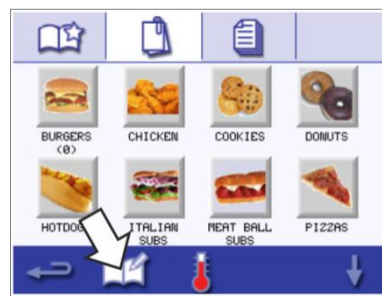

4. Select the 'camera' symbol to open a database of pictures.
5. Select a picture for the cooking profile group. You can use the scroll arrows at the bottom of the screen for more pictures.
6. Enter a name for the new cooking profile group (max. 20 characters) and press the green checkmark to save it.

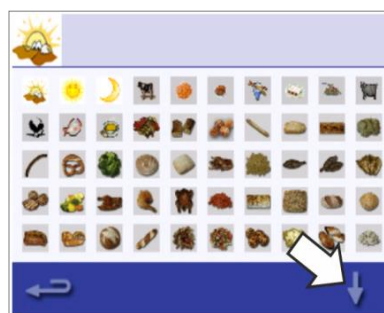
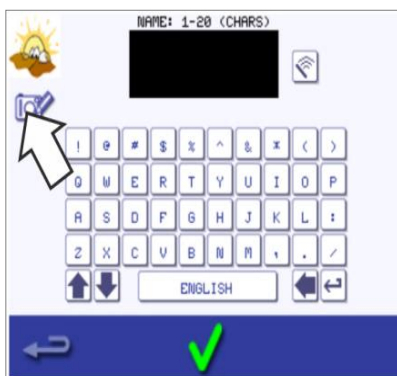

Adding a cooking profile to a group of cooking profiles

1. Select 'cookbook' from the main menu screen.
2. Select the cooking profile group you want to add to.
3. Select the 'edit cookbook' symbol in the cooking profile screen.

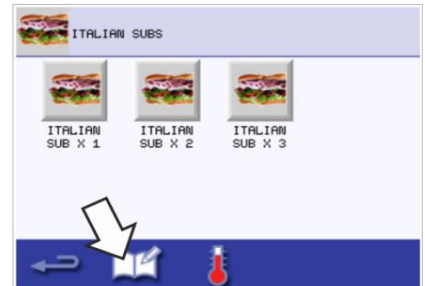
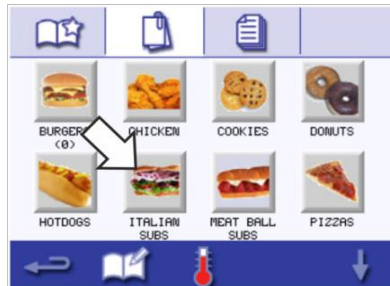

4. Use the up/down scroll arrows on the right to find and select the cooking profile you want to add.
5. Select the green 'left' arrow to add the selected cooking profile, which will now be listed on the left.

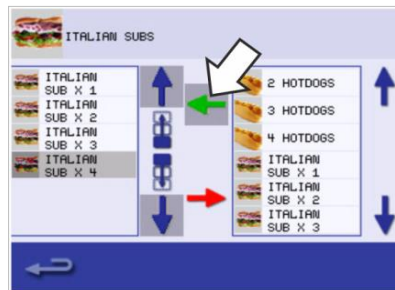
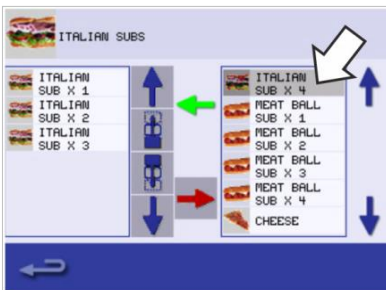

Deleting a cooking profile group

1. Select 'cookbook' from the main menu screen.
2. Select the cooking profile group to delete.
3. Select the 'edit cookbook' symbol.



4. Select the 'delete cooking profile group' symbol.
5. Select the green checkmark to delete the cooking profile group.

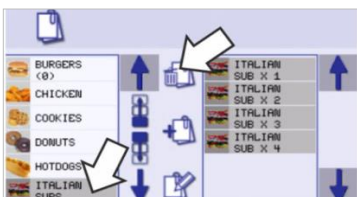

Editing a selected cooking profile group name

1. Select 'cookbook' from the main menu screen.



2. Select the 'edit cookbook' symbol from the cookbook screen.

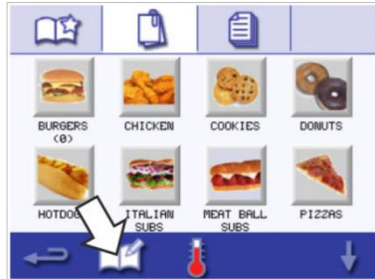

3. Select the cooking profile group that you want to edit.

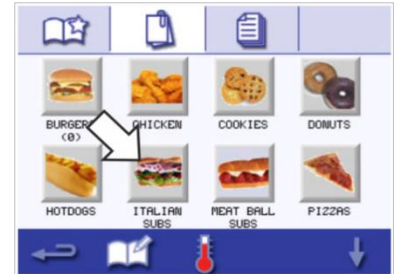

4. Select the 'edit cooking profile group' symbol.

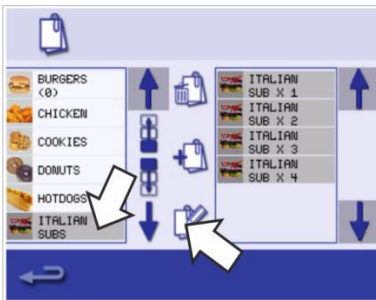

5. Enter the new name of the cooking profile group and select the green checkmark to continue.



2F. Changing settings

Changing settings process

1. Select the 'settings'  symbol from the main menu screen.

Note: The main menu is displayed after the oven is pre-heated. If you want to change settings without pre-heating the oven, for example change settings before first usage, you should tap the first screen to hold it and then press the hidden key at the top right-hand corner to load the password screen, shown in step 2.



2. Enter your password and select the green checkmark to display the 'settings' options.



3. Make changes as required. Use the up/down scroll arrows at the bottom of the screen to display all functions of the 'settings' menu.

The 'settings' menu comprises the following functions:

- A. Operating mode / navigation settings
- B. Language options
- C. Cavity temperature settings and labels
- D. Service information and error logs
- E. Cooking profile counters
- F. Date and time settings
- G. Speaker and sound level settings
- H. Timer (Temperature / ON / OFF)
- J. USB program downloads
- K. Temperature band settings
- L. Change settings / service access passwords
- M. Screen saver

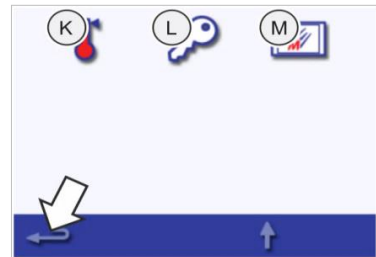
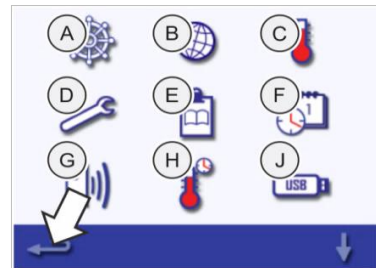

When finished with a setting, select backspace to return to the main settings menu to make other changes.

4. Press the backspace button to exit the 'settings' menu. A prompt appears to either 'SAVE' or 'DISCARD' any changed settings.

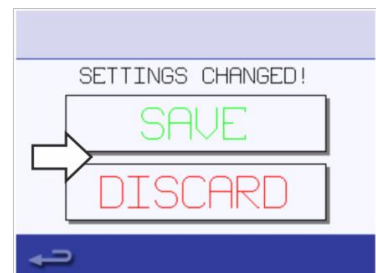

Operating mode / navigation settings

1. Select the 'operating mode/navigation' symbol from the settings menu.



2. Select 'QUICK SERVE MODE' for cooking only.
Select 'FULL SERVE MODE' for creating cooking profiles.
Select 'MANUAL MODE' to manually cook only via the 'chef's hat' symbol on the main menu screen.
Select 'ENABLE SETTINGS' to display an 'unlock' symbol on the 'Quick Serve Mode' screen to allow access to the 'settings' menu.

Note: If a green checkmark is displayed, the corresponding function is active.



3. Select 'MAGNETRON ENERGY DELAY' to enable a magnetron warm up period for all cooking profiles.

Select 'ENERGY SAVING' to enable the hibernation mode when the oven is inactive.

Language settings

1. Select the 'globe' symbol from the settings menu



2. Select the checkbox(es) of the required language(s) from the list shown.



Cavity temperature settings and labels

1. Select the 'temperature' symbol from the settings menu.

The temperature screen is displayed if two or more cavity temperatures are set above the minimum. You can now:

- A) Change a temperature set
- B) Edit the existing temperature labels
- C) Add a new temperature
- D) Change the measurement unit

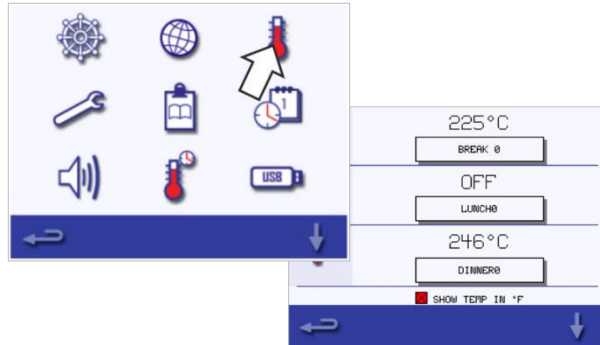

A) Change a temperature set

1. Select the temperature you want to change by tapping the value or the red temperature symbol next to it.
2. Edit the temperature as required using the keypad.
3. Select the checkmark to continue.

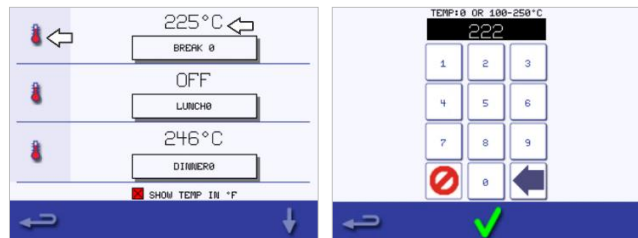

B) Edit temperature labels

1. Select the required label below the temperature.
2. Edit the label as required using the keypad.
3. Select the checkmark to continue.

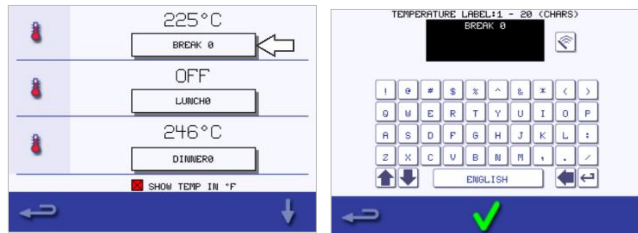

C) Add a new temperature

1. Select a disabled temperature option from the screen (scroll down using arrow if required).
2. Select the temperature area marked as 'disabled' or the red temperature symbol.
3. Enter a temperature value using the keypad and select the checkmark to continue.
4. Select the 'Optional Label' box to assign a label to the temperature and select the checkmark to continue.

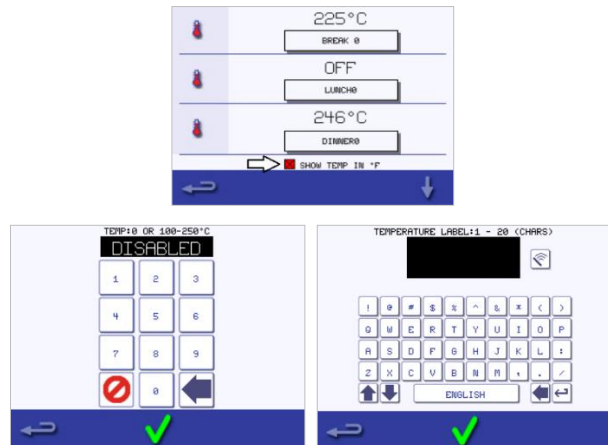

D) Change measurement unit

You can change the temperature measurement unit from Celsius to Fahrenheit and Fahrenheit to Celsius by simply selecting or deselecting the unit checkbox.

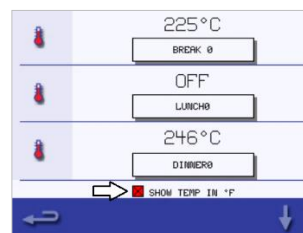

Service information and error logs

The service information and error log function is required for servicing and repairing the system and therefore covered in *Section 3: Service and Repair*.



Cooking profile counters

1. Select the 'clipboard' symbol to display a listing of cooking profile counters.



2. The recipe counts are listed on the right of the screen. Use the up/down arrows at the bottom of the screen to scroll to the required recipe.

RECIPE COUNTERS	
TEST	0
APPLE STRUDEL	0
BAKED GOODS	0
BAGUETTE LONG	0
BAGUETTE BUN	0
SUPPLE- MENTS	0

Adding recipes

Recipes can be uploaded from a USB stick. See *USB program downloads*.

Removing recipes

You can remove a recipe by selecting it and then selecting the bin symbol.

Setting the date and time

1. Select the 'clock/date' symbol from the settings menu to display the setting options.



Change the date:

2. Select 'MONTH', enter the correct month on the keypad and select OK.
3. Select 'DAY', enter the correct day on the keypad and select OK.
4. Select 'YEAR', enter the correct last two digits of the year on the keypad and select OK.
To display the month first, followed by the day and year, select the 'MM-DD-YY' checkbox.
A correct date supports servicing as the error logs are recorded using these date settings.

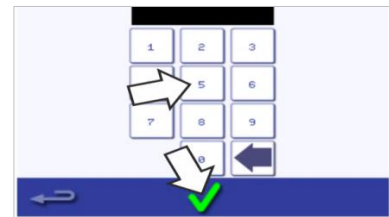
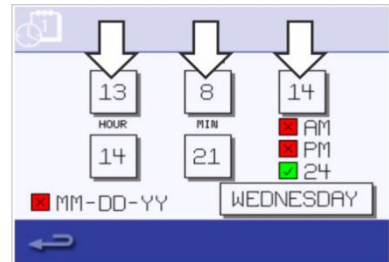

Change the time:

5. Select 'HOUR', enter the correct hour on the keypad and select OK.
6. Select 'MIN', enter the correct minutes on the keypad and select OK.

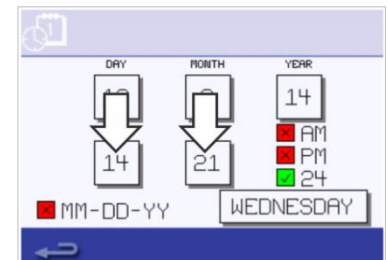

7. Select the day name.

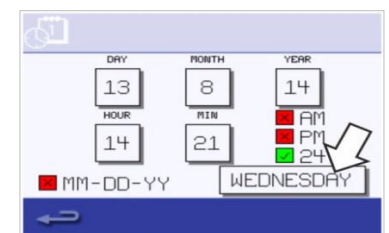

Sound settings

1. Select the 'speaker' symbol to access the volume, tone and further sound settings.



2. Make changes as required:

- a) Select the 'speaker' symbol to adjust the volume level suitable for the environment from none (OFF) to the loudest (100%).
- b) Select the 'music note' symbol to set LOW, MED or HIGH tone.
- c) Select the 'keypad' symbol to switch the sound ON or OFF when the touchscreen is pressed.



Temperature timer setting

1. Select the 'thermometer / timer' symbol from the settings menu.



2. Select the 'timer enabled' checkbox (green checkmark).
3. Select a weekday using the up/down arrows at the bottom of the screen.
4. Select an empty 'time' box (maximum of five per day) or clear an existing 'time' box using the 'wipe' symbol next to it.

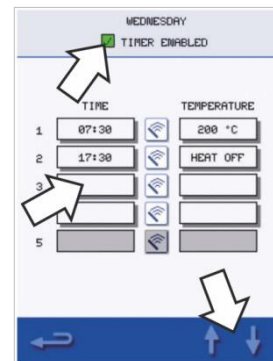

5. Enter the start time on the keypad.
Press the green checkmark to continue.

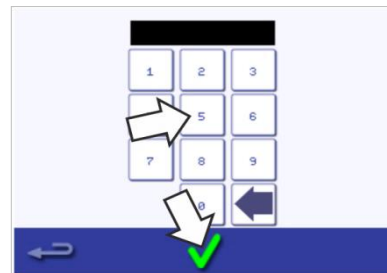

6. Select an empty 'temperature' box opposite the respective 'time' box or clear the required 'temperature' box using the 'wipe' symbol next to it.

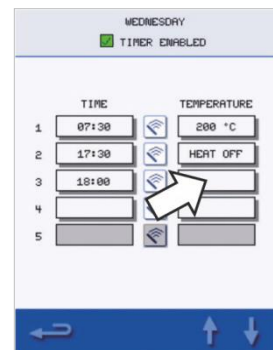

7. Enter the cavity temperature required on the keypad.

Alternatively:

- Select zero to turn the heat OFF.
- Select the red circle symbol to switch OFF the appliance.

Press the green checkmark to continue.

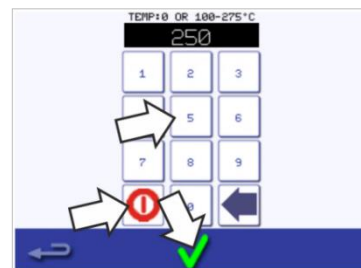

USB program downloads

1. Switch the appliance OFF and open the cover to the USB port on the control panel.

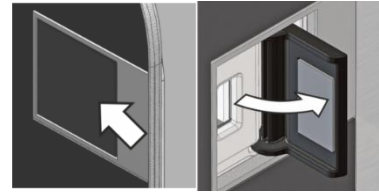

2. Plug in the USB memory stick and switch on the oven.

Note: If the USB memory stick is too large, use a standard commercial adapter cable.

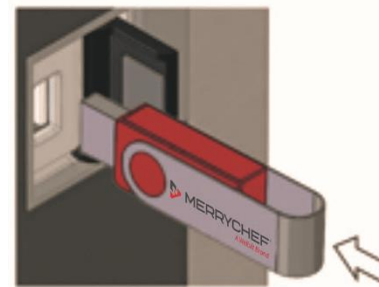

3. Select the 'USB' symbol from the settings menu.

Note: Check that the memory stick has the correct number/code for the programs you want to load into the memory (one '.cbr' file and 'autoupdate').



4. Select the type of file you are downloading (firmware or recipes). The files will now automatically download from the USB memory stick showing the progress and confirmation screens for the update.



IMPORTANT: Downloading from a USB memory stick will clear all the existing programs in the memory of the appliance.



The USB cover protects the USB port so that no water vapor can get into the control electronics. During cooking and cleaning, there must not be a USB memory stick inserted and the USB port must be closed by the cover.



Temperature band setting

5. Select the 'temperature band' symbol.



6. Select the required temperature band checkbox, shown by a green checkmark.

Note: Generally, the lowest practical 'Temp Band' should be chosen. If the set cavity temperature falls by more than the selected temperature band value, the ready-to-cook mode and the temperature band are deactivated until the cavity reaches the preset preheat temperature.

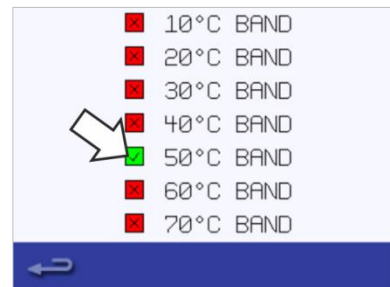

Change setting / service access password

7. Select the 'key' symbol to change the passwords of the appliance.



8. Select the appliance 'settings' or 'service' symbol.

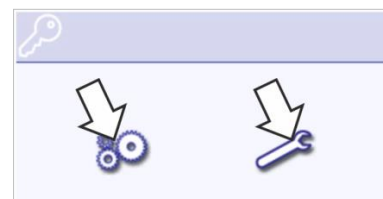

9. Enter the existing password and press the green checkmark to confirm.

10. Enter a new password and press the green checkmark.

11. Confirm the new password and press the green checkmark again.



Set screen saver

12. Select the 'ENABLED' checkbox to switch the screen saver ON or OFF and select the 'time' box below it.



2. Enter a time delay on the keypad from 1 to 60 minutes before the screen saver starts. Press the green checkmark to confirm.

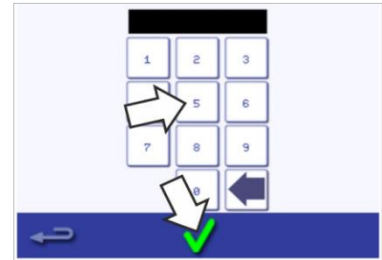

3. An active screen saver will mask the screen showing a moving image. To use the touchscreen, tap the screen to deactivate the screen saver.

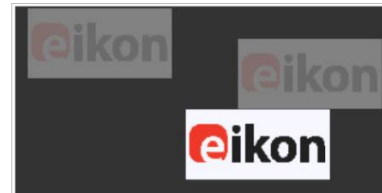

2G. Cool-down procedures



The microwave combination oven must be cooled down properly before cleaning, servicing or repairing. Users must read *Section 1H: Hazards and safety precautions during servicing and repair* and *Section 1I: Hazards and safety precautions when taking the appliance out of service*.

To cool down the appliance:

1. Select the thermometer symbol from the cookbook or the cleaning symbol from the main menu (full serve mode).



2. In the temperature screen, select the blue thermometer symbol to disable heating and start the cooling cycle.



3. The cooling progress is displayed and takes approximately 20 minutes. To reduce the cool-down time, leave the appliance door open slightly during the cooling process.

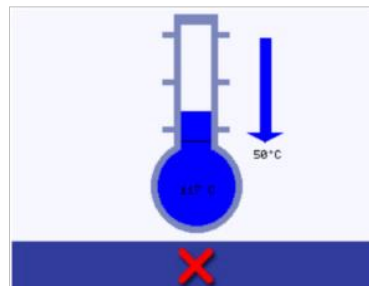

4. Once the cooling process is complete, you will see a 'Clean Cavity' screen. The oven is now ready for cleaning or servicing and repairing.

Cleaning instructions is provided in *Section 2H: Cleaning procedures*.

Servicing and repairing is covered in *Section 3*.



2H. Cleaning procedures

Daily cleaning tasks

What must be cleaned?	Procedure	Cleaning chemicals
Cavity	Clean by hand with a soft cloth or paper towel	Cleaning and protective chemicals approved by the manufacturer
Outside of appliance	Clean by hand with a soft cloth	Common household stainless-steel cleaner or hard surface cleaner
Containers, baking sheets, shelf grills and other accessories used for cooking	Clean by hand with a soft non-abrasive sponge and rinse off after with water	Common household detergent
Air filter	Wipe clean or wash in soapy water	Common household detergent

Table 2.5: Cleaning tasks

Cleaning items

Use solely the cleaning chemicals specified in Table 2.6 to clean the microwave combination oven and its accessories.







Product		Use
Merrychef Cleaner		Cleaning the cavity and appliance door
Merrychef Protector		Protecting the cavity and appliance door
Common household stainless-steel cleaner or hard surface cleaner		Caring for the external surfaces of the microwave combination oven
Common household detergent: mild on skin, alkali-free, pH-neutral and odourless		Cleaning components and accessories and fittings according to relevant instructions
Protective rubber gloves		To protect hands from cleaning agents
Non-abrasive nylon scrub pad		For all surface and door cleaning
Cleaning towel and cloths		For all surface and door cleaning
Eye protection		To protect eyes from cleaning agents
Dust mask (optional)		To protect from inhaling cleaning agents

Table 2.6: Cleaning items



Cleaning instructions



- Ensure the oven has been cooled down as per the instructions in *Section 2G: Cool-down procedures*.
- Users must read *Section 1G: Hazards and safety precautions during cleaning*.
- Wear protective glasses and protective rubber gloves during cleaning.

CAUTION

- Never use sharp implements or harsh abrasives on any part of the appliance.
- Do not use caustic cleaners on any part of the appliance or cavity.
- Do not scrub the roof (jet plate) or door seal.
- Do not use metallic scourers on any part of the appliance at any time.
- Do not spray cleaning product directly into the cavity.
- Do not use the appliance without a clean air filter in place.

Pre-cleaning checklist

- The appliance has been cooled down correctly
- No food has been left in the cavity.
- All containers, baking sheets, shelf grills and any other accessories have been removed from the cavity.

Cleaning process

There are several stages in the cleaning process:

Stage 1: Clean and dry the oven and oven parts

Stage 2: Apply oven protector (optional)

Stage 3: Clean the air filter and external surfaces

Stage 4: Cure the protective chemical (if oven protector applied)



Stage 1: Clean and dry the oven and oven parts

1. In a cooled-down oven (see section 2G), open the door and remove the cook plate and any other cooking accessories.

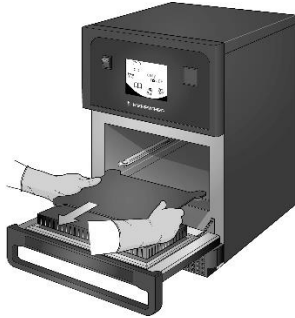

2. Wash all removed oven parts in warm soapy water. Wash off using a clean cloth and plenty of warm water.

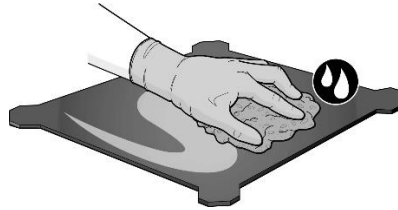

3. Use a dry clean brush to remove any food particles from between the cavity floor and the inside of the front door.

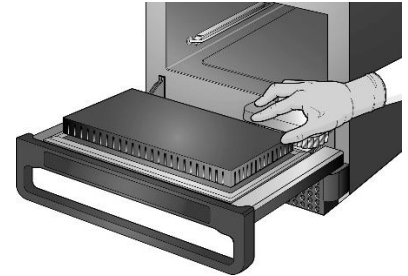

4. Spray Merrychef approved cleaner onto a sponge and clean all internal surfaces **except the cavity roof (jet plate) and door seal**.

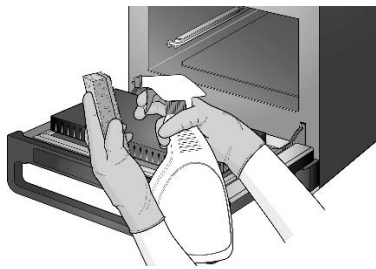

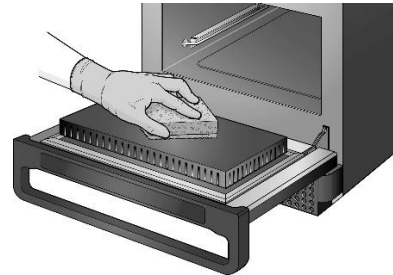

5. For difficult areas, leave to soak for 10 minutes with the appliance door open. Use a non-abrasive nylon scrub.

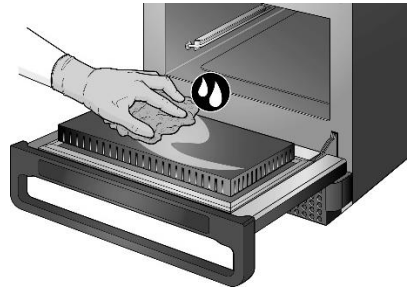

6. Wash off all surfaces using a wet clean cloth. The cavity roof and door seal can be wiped clean with a wet clean cloth as well.



 Do not spray directly into the cavity.

 Do not scrub.

7. Dry all surfaces and oven parts using a clean cloth or paper towel.

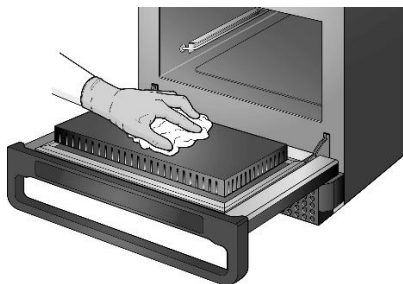

8. Press the checkmark on the clean cavity screen to continue.



9. A prompt will appear to apply the oven protector (optional).



Stage 2: Apply oven protector (optional)

1. Spray Merrychef protector or a Merrychef approved protector onto a clean sponge.

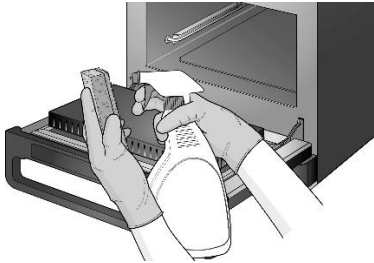

2. Spread the protective chemical lightly onto all internal surfaces, avoiding the roof (jet plate) and door seal.

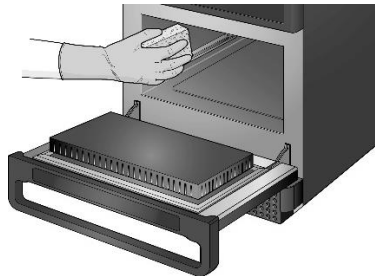

3. Replace the cleaned and dried cook plate.

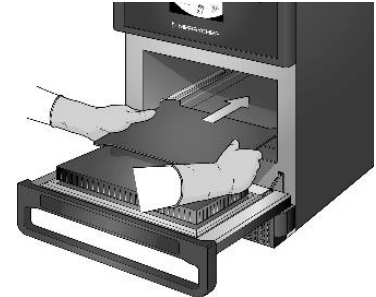

4. Press the checkmark on the apply oven protector screen to continue.



5. A prompt appears to clean the air filter.



Stage 3: Clean the air filter and external surfaces

1. Remove the air filter by gently pulling it.

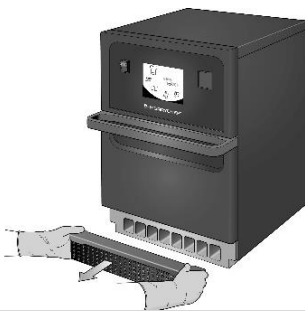

2. Wipe the air filter clean or wash in soapy water.

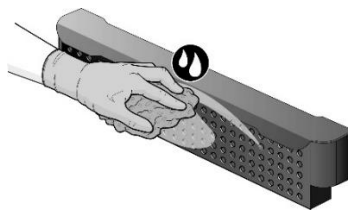

3. Dry and replace the air filter.

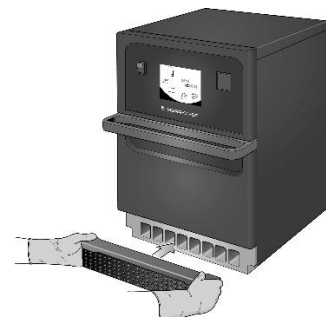

4. Press the green checkmark to confirm cleaning of the air filter.



5. The oven switches OFF automatically.



6. Wipe the external surfaces of the oven with a damp cloth.



Stage 4: Cure protective chemical (if oven protector applied)

1. Switch ON the appliance using the on/off button.



2. Preheat the cavity. Once reaching the preset operating temperature it will take about 30 minutes to cure the protective chemical.

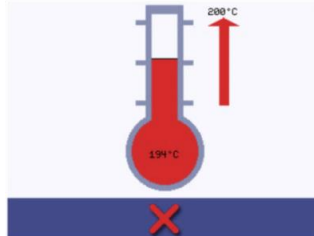

3. The protective chemical turns light brown when cured and the oven is ready to be used again.



21. End of day operations

Turning the oven off

- 1.



Switch off the microwave combination oven using the on/off switch at the front of the appliance.

- 2.



Leave the appliance door ajar to let moisture escape.

Note: Switch off the power on site, before prolonged breaks in use.



2J. Warranty information and contacting customer services

In order to be able to claim under the warranty for the microwave combination oven, the appliance must be installed in accordance with the instructions in the *Operations and Installation Guide* by a qualified service engineer from an authorized service company.

The warranty does not cover damage resulting from improper setup, installation, use, cleaning, use of cleaning chemicals, servicing or repair.

Required information

Please have the following appliance data to hand when contacting Welbilt customer service:

- Serial number of your appliance
- Part number if you are calling about a specific part of the appliance

This serial number of the appliance can be found at the rear of the oven on the nameplate, as shown in Figure 2.5.



Figure 2.5: e1s rear view with nameplate

Contact data

Welbilt UK Ltd.
Ashbourne House, The Guildway,
Old Portsmouth Road
Guildford, GU3 1LR
United Kingdom
Tel: +44 (0) 1483 464900
Fax: +44 (0) 1483 464905
Website: www.merrychef.com and www.welbilt.com



For further information on servicing, maintenance and repair, please refer to *Section 3: Service and Repair*.



Section 3: Service and Repair



3A. Technical data summary

Dimensions and weight

Size and weight (without packaging)

- Width of appliance = 406.4mm (16")
- Total depth with door open = 806.9mm (31.8")
- Depth with door closed = 538mm (21.2")
- Counter depth = 499.0mm (19.6")
- Net weight = 46.0 kg (101 lbs)

Safety clearances

- The minimum height of free space necessary above the top surface of the appliance is 50mm (2").
- Safety clearance on left-/right-hand side / at rear: 0mm

Electrical specifications



See **Error! Reference source not found.** in Section 2B.

Power and heat

Microwave power

- Microwave settings, off or 5–100% in 1% increments

Convected heat

- Temperature settings OFF and from 100°C to 260° C / 212°F to 500°F in 1°C steps

Noise emission

The weighted emission sound pressure is <70 dBA.

Regulatory standards compliance



See Section 1: Safety for details of regulatory standards and directives.



Dimensional drawings

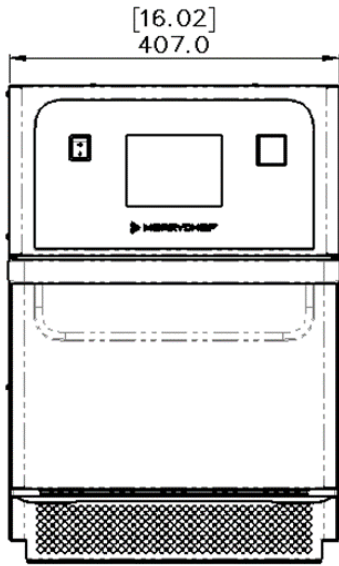

Front view (door closed)

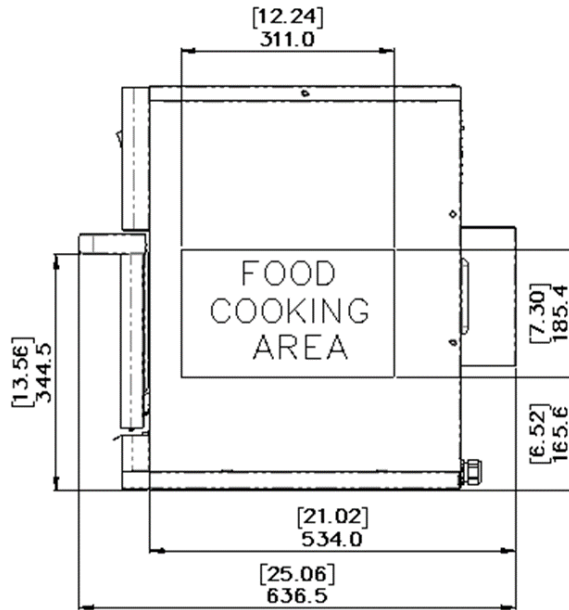

Cavity dimensions (door closed)

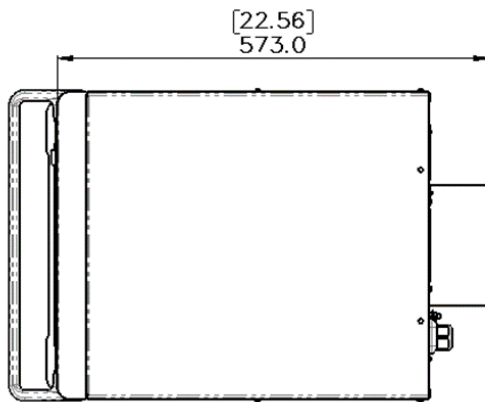

View from the top (door closed)

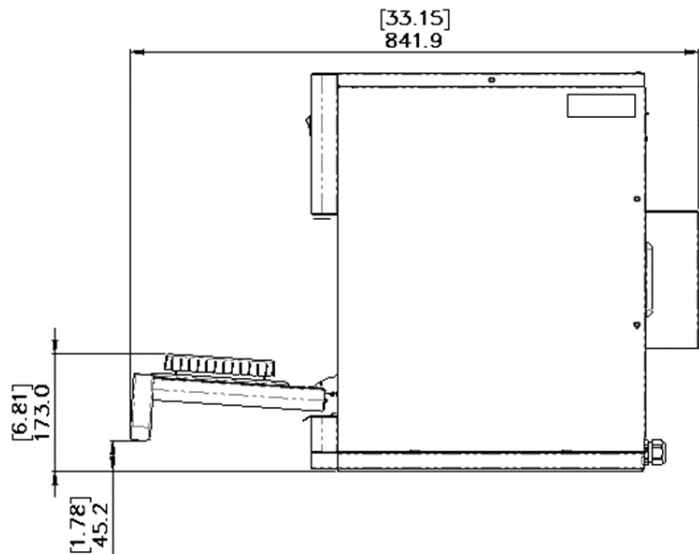

View from the right-hand side (door open)

Figure 3.5: e1s dimensions with doors open and closed



3B. Diagnostics

Checking the condition of your appliance

Servicing procedure: overview

1. Disconnect/isolate the appliance from the power supply.
2. Check the appliance is correctly installed as described in the "Installation" section of this manual.
3. Visually check the cleanliness/condition of the power supply/cable/gland, casing, cavity and door of the appliance for signs of wear, damage, distortion etc. If required, refer to the "Replacing components" section of this manual.
4. Complete an "Earth/Insulation test" (see "Tests" section of this manual) on the appliance before switching on.
5. Check the display for error messages. If an error is shown, refer to the error codes in Table 3.7 in Section 3C.
6. If a firmware update is required, follow the instructions in 3E. - *Firmware updates* before continuing with the service procedure.

Entering Service Mode

4. Tap to hold the first screen upon switching on, press the hidden button at the top right-hand corner to load the password screen.



5. Enter the administration password. The default password is 'MANAGER'. Select OK (green checkmark) to display the 'Settings' menu.

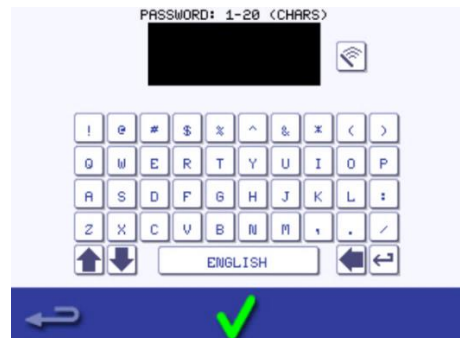

6. Select the spanner symbol from the Settings menu.



7. Enter the service password and select OK to display the error log, service information and test options.

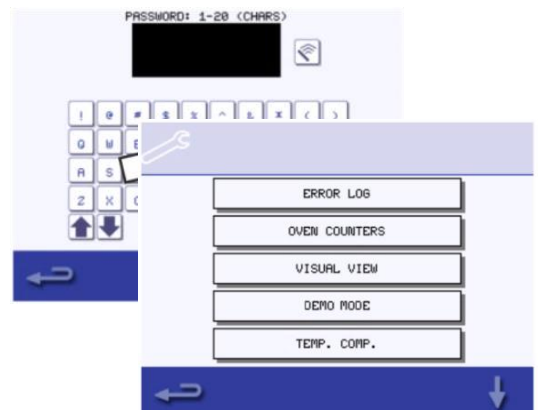

Functions of the Service Mode

Once in 'Service Mode', you can do the following by selecting the relevant option on screen:

1. Check the 'Error Log' for details of any logged appliance errors.
2. Check the 'Oven Counters' to find the usage of components and the controls area temperature within the cabinet.
3. Check the operational performance of the main components using 'Visual View'.
4. Switch to 'Demo Mode'. This switches the oven into a demonstration mode where the oven will act as though it is heating and cooking but does not use the microwave or heating circuits. Can be used for training or customer demonstrations.
5. The 'Temp. Comp.' option enables calibration of cavity temperature. Cavity temperature is factory set and should not require adjustment. If cavity temperature calibration is required, contact the manufacturer.
6. Several tests are available in service mode that ensure the appliance is operating correctly. The up and down arrows highlighted below can be used to select the required test. Test procedures are covered in *Section 3D*.

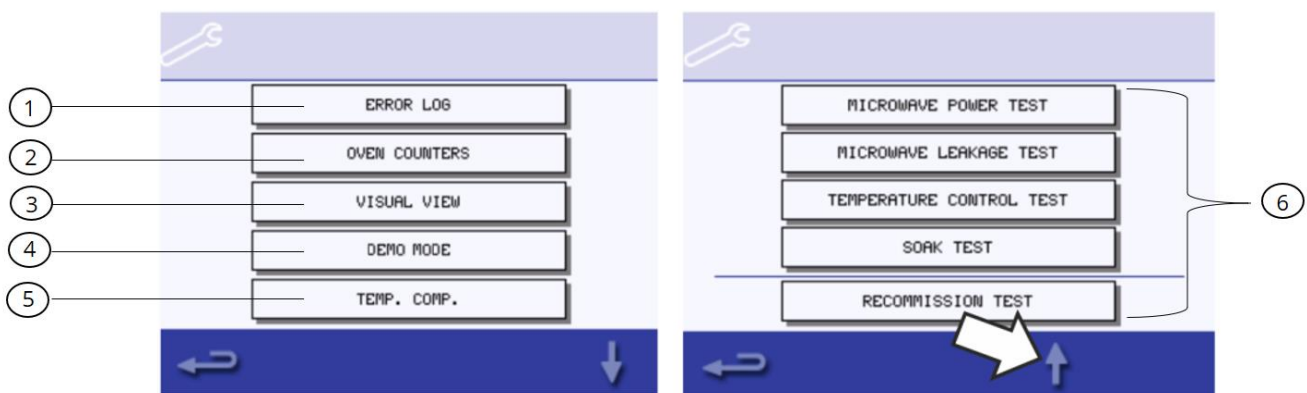

Errors and diagnostics

Viewing error messages

In the instance of a major error, a description of the type of error is shown by the system when switched on. The on-screen message will show a description of the type of error along with some instructions on what action to take. The error code as 'Exxx' will be displayed and the serial number of the oven, model, UI (QTS) version and SRB version information are also displayed as shown on the Error screen.

You can use the error code to determine the nature of the problem by referring to the error codes in *Table 3.7* in *Section 3F*.

Clearing error messages

You can clear an error message by power cycling the mains power supply to the oven (not the oven ON/OFF switch).



Viewing the Error Log

1. Enter service mode and select 'Error Log' to display a listing of oven component errors.

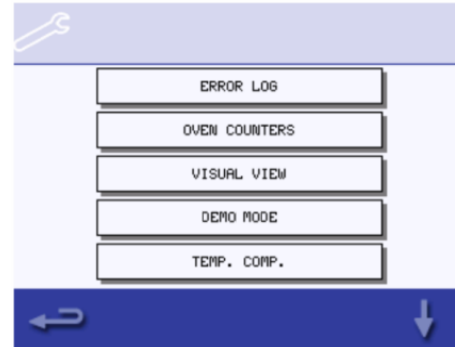

2. Scroll down the list (if necessary) and select an error from the list to display individual records.

Note: The 'Failure' column shows the error code assigned by the appliance which a service Merrychef Service Engineer may request if contacted.

ERROR	DATE TIME	FAILURE
OVERHEAT STATS RELEASED	07/07/09	E071
HIGH SUPPLY VOLT/ LOW FREQ	07/07/09 16:57	E072
CAVITY OVERHEATED	05/03/09 17:53	E073
COMM ERROR	06/10/09 18:54	E074
BTS FM FAILED	07/11/09 19:55	E075
SRB FM FAILED	08/12/09 20:56	E076
SRB VERSION CONFLICT	09/13/09 21:57	E077

3. A variety of information is displayed for each error. You can also use the error code to look up details of the fault using the table in 3C – Fault Finding.

Note: Select backspace  at any point to return to the error log and again to return to the Service Menu.

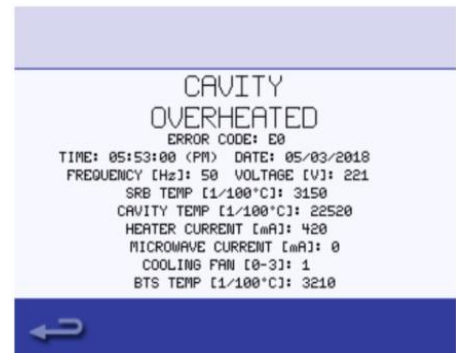

Copying error messages onto USB sticks

8. Enter settings menu select the 'USB' symbol. The USB screen appears.



9. Open the cover of the USB port and insert the USB memory stick into the slot.

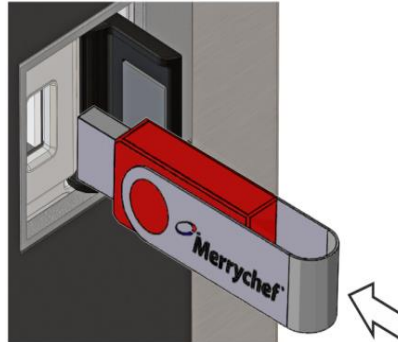

Note: The USB memory stick may take several seconds to load before the screen will respond.

You can use any USB up to 128GB but you are advised to format it before use (FAT32).

10. Select 'Files to USB' on the USB screen.

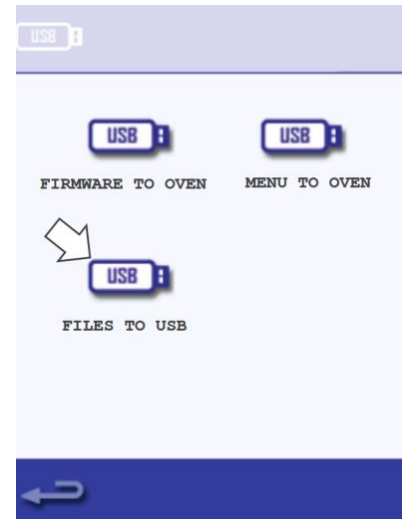

11. Select 'Error Log' on the following screen.

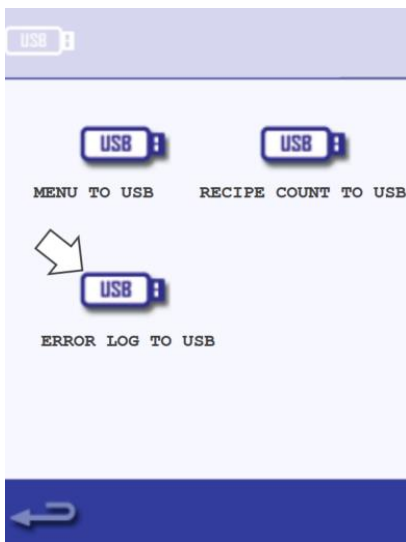

12. Select the green checkmark to copy the error log to the USB memory stick. The upload progress is shown followed by the upload status.



13. Select backspace  three times to return to the main menu and then remove the USB memory stick.

Oven counters

The Oven Counters option in service mode is used to display the oven component usage. This information can be requested by service and manufacturer engineers to give indication of component life expectancy.

1. In Service Mode, select 'Oven Counters' to display the oven component usage and ambient controls area temperature.



2. Details include the number of screen touches, filter cycles, door cycles, total oven power, magnetron and heater element power on time and the ambient controls area temperature in the cabinet.

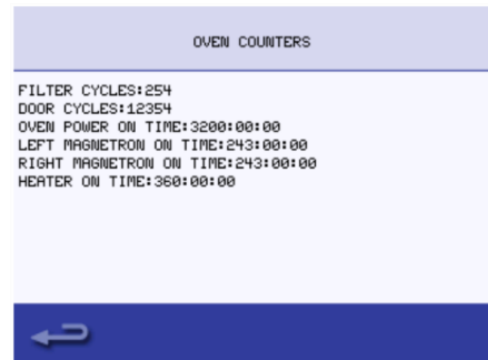

3. Select backspace to return to the Service Menu.

Health checks of components

Procedure: Service Mode > Visual View

The **Visual View** option in Service Mode allows you to do health checks on some of the components of the application, including:

- The oven door
- Cooling fan
- Magnetron
- Convection fan
- Heater

Instructions on how to check each component are provided below once you have entered Service Mode and selected Visual View is provided below.



Check oven door

- Open the oven door.
- Check the colour of the door symbol changes from green to red on the display to check the door microswitch circuit is operating.
- Place door spacers onto the oven door (refer to *Adjusting the door microswitches* in Section 3F for details), close the door and check the colour of the door symbol on the display.

Green colouring indicates that the door microswitch adjustment is ok.

Red colouring indicates that the door microswitch adjustment procedure must be completed.

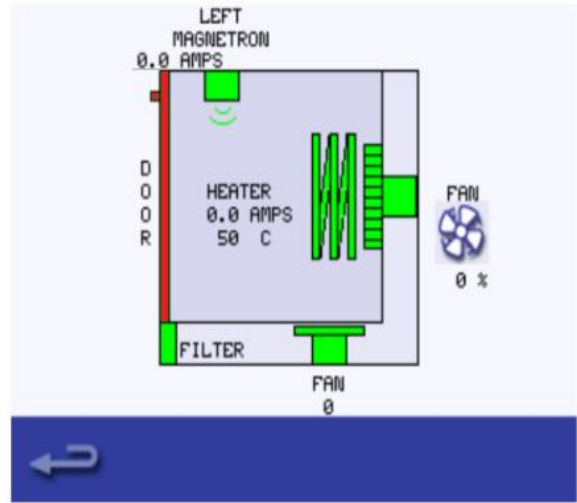

Check cooling fan

- Select the cooling fan symbol so it becomes red.
- Increase and decrease the fan power from 0% (Off) to 100% (Max).
- When increasing the fan power from the fan noise should become louder.

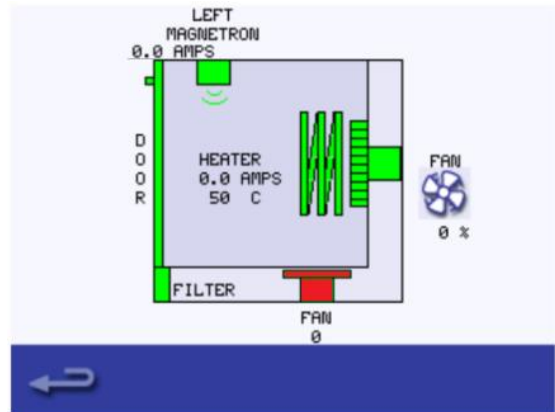

Check convection fan

Pressing the fan icon increases the fan power in 10% steps and from 100% to 0%. Pressing the fan symbol in the diagram switches the fan to 100% power.

When increasing the fan power gradually to 100% the fan noise should become louder.

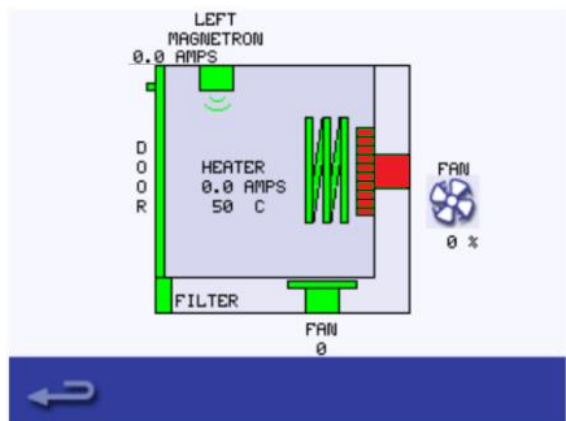

Check magnetron

Select the magnetron and check it is operating correctly.

Place a microwave safe container of water into the cavity, and close the oven door.

Select the magnetron to test the current draw at maximum output, this will time-out after 30 seconds.

Test the magnetron.

Using heat proof gloves, remove the container and close the oven door.

Magnetron test:

If there is a magnetron error present, then first reset the error.

If during the magnetron test the current is between 1.1 - 2.2 A and the error re-occurs after eight seconds, then the failure can be found in the 230V circuit.

Refer to the schematics to find the fault for repair (fuses, SRB, door switches, connections, power supply).

If the current is 0 A during the magnetron test and the error reoccurs after eight seconds then the failure can be found in the high voltage circuit.

Replace high voltage components (diode/rectifier, capacitor or magnetron) to find out the failing component. Never measure in the high voltage circuit. See "Replacing components" section of this manual.

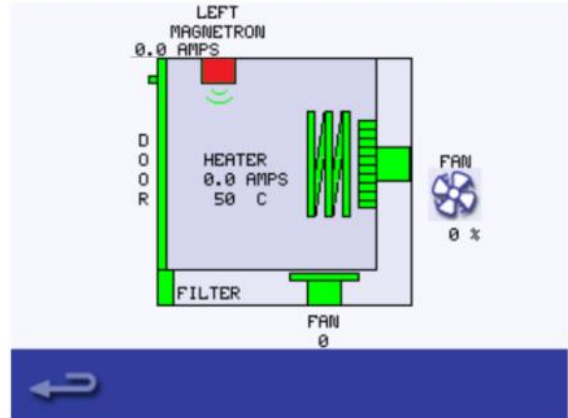

Check heater

Select the heater, it increases to maximum temperature and then cycles (the convection fan is ON by default).

Check the cavity temperature increases and the heater element current draw at maximum is correct. The current should be between 8 A and 11 A depending on domestic mains voltage.

Note: If the heater is near maximum temperature the oven will not draw maximum current. It is advised to run this test when the oven is cold.

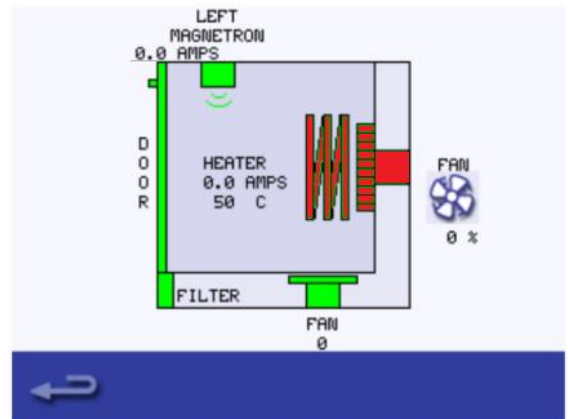

Touchscreen calibration

Should the touchscreen behave in an inconsistent manner, the touchscreen can be re-calibrated.

1. Apply continuous light pressure to the screen while switching the appliance on.
Continue to hold until the progress bar has completed.

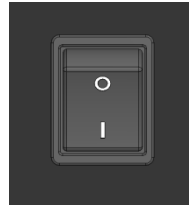

2. Using a non-abrasive pointer, such as a ball point pen, accurately press the centre of each crosshair displayed on the screen.

Note: If a crosshair turns red, you missed the centre of the crosshair and should repeat the procedure.

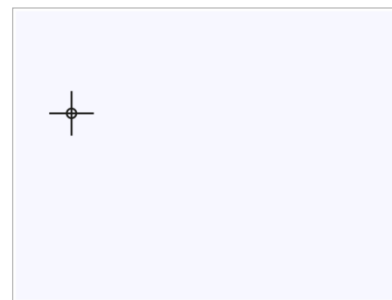

3. If the crosshair turns red you missed the centre of the crosshair.
Repeat the procedure.

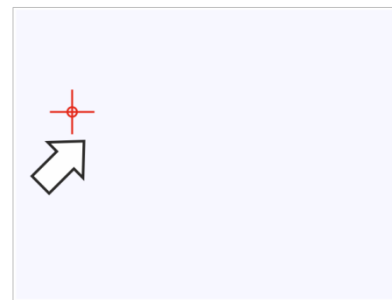

4. If the crosshairs turn green three times consecutively the calibration process is completed successfully.

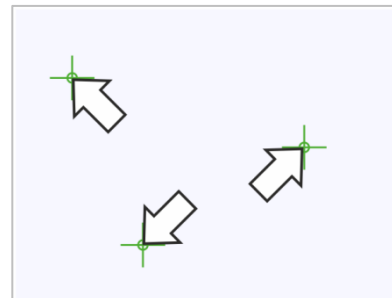

5. Once calibrated the screen will display information about the appliance.



3C. Fault Finding

There are many error codes that the system may display, depending on the cause of the problem and the parts associated. The tables below list the error codes that may be displayed with their meaning and the system's response to the errors.

Error code list

Error Code	Error Condition	Description	Trigger	Possible Causes	System Response	Action
E 101	Magnetron failed to energize	Detects a magnetron is not working correctly.	The current measured by the current sensing transformer was outside of tolerance.	Failure of component/s in the microwave circuit	Display error message until system is power cycled (see footnote).	Check high voltage microwave circuit.
E 102	Heater on without request	Detects a heating element is not working correctly.	A rise in a cavity temperature 25 °C over setpoint in a given period of time.	Stalled convection motor or heater element/ SRB issue	Display error message until system is power cycled (see footnote).	Run heater element diagnostics.
E 103	Ambient overheat >60°C	Detects if the controls area is operating above temperature.	The ambient temperature measured on the QTS and SRB was >60°C.	Cooling fan failed. Cooling fan wired incorrectly. Inlet air too hot. Blocked air filter.	Display clean air filter and oven cooling until ambient controls area temperature is below 50°C.	Ensure oven is cooling correctly.
E 104	Magnetron / cavity overheat	Detects if the cavity and magnetrons are above temperature.	Cavity and magnetron overheat thermostats.	Cooling fan failed. E103 / E106 not triggering. Failed SRB. Magnetron failure. Wiring / connection fault. Blocked inlet filter.	Display error message until service call and the magnetron cools down or the cavity stat is reset.	Press the cavity reset button the rear panel of the appliance. Restart, if error repeats it is a cavity stat trip. If not suspect mag stat trip.
E 105	Supply frequency high / low	Detects if the power supply frequency is outside specification.	The power supply to the oven frequency sensor on the SRB measures too high / low.	Incorrect mains voltage. Poor internal / external wiring connections. Faulty SRB.	Error not displayed, stored in error log.	If not resolved download error log for review by manufacturer.
E 106	Cavity reaches 300°C once it has been controlling at setpoint	Detects if the cavity temperature has risen above limit.	The setpoint of the appliance was exceeded.	Cavity fire. Failed convection fan. No impeller or loose impeller on convection fan.	Display error message until system is power cycled (see footnote).	Check cavity. Ensure convection fan is operational.
E 107	Communication error	No communication can be made between the QTS and SRB.	Loss of communication between the SRB and QTS.	SRB / QTS connection cable unplugged or damaged. Faulty QTS or SRB.	Display error message until system is power cycled (see footnote).	Check SRB/QTS connections.
E 108	QTS PM error	Wrong PM found / no PM found.	The QTS or SRB either has an incorrect PM (Personality Module) fitted or no PM is fitted.	The PM has been changed and is incorrect. The PM has been removed.	Display error message until system is power cycled (see footnote).	Check PM is fitted correctly.
E 109	SRB PM error	Wrong PM found / no PM found.	The QTS or SRB either has an incorrect PM (Personality Module) fitted or no PM is fitted.	The PM has been changed and is incorrect. The PM has been removed.	Display error message until system is power cycled (see footnote).	Check PM is fitted correctly.
E 110	SRB version conflict	SRB firmware version incompatible with QTS version.	The QTS has found that the firmware running the SRB is not supported.	Firmware update has been carried out to the QTS and the SRB has not been updated to match.	Display error message until system is power cycled.	Ensure firmware is up to date.



Error Code	Error Condition	Description	Trigger	Possible Causes	System Response	Action
E 111	Cavity sensor error	Cavity sensor broken / unplugged.	The controller is reading an open circuit across the thermocouple input.	The thermocouple is not connected. The thermocouple is broken open circuit. Failed SRB.	Display error message until system is power cycled (see footnote).	Replace thermocouple and check connection to SRB.
E 112	SRB sensor fail	SRB ambient temperature sensor failure	Shorted SRB temperature sensor.	Shorted Ambient temp sensor on the SRB.	Display error message until service call and the magnetron cools down or the cavity stat.	Replace SRB.
E 113	Magnetron fail on without request	Magnetron operates without being requested to do so.	Magnetron current sensed at > 1 Amp.	Triac, Diode or relay short circuited on SRB.	Display error message until service call and the magnetron cools down or the cavity stat is reset.	Check power supply to oven. Replace SRB.
E 116	Heater off on request	No heater heat rise in cavity.	Cavity does not reach 100°C in 30 minutes.	Oven heater element failure.	Display error message until service call and the magnetron cools down or the cavity thermostat is reset.	Check heater element.
E 117	Magnetron overheat thermostat	Magnetron overheat thermostat has been triggered as a result of excessive temperature.	Magnetron stat is open circuit when running microwave.	Blocked air filters / high environmental temperatures / Positioning next to heat sources or failed magnetron.	Display error message until service call and the magnetron cools down or the cavity thermostat is reset.	Check magnetron is being cooled successfully.
n/a	Oven door open longer than 1 min.	Oven door open. Oven inoperable.	Break in switched feed on SRB.	Door left open. Failed door switch/s or SRB. Faulty wiring or connection.	Display warning message until door is closed.	If door is closed check microswitches and fuses.
EO87	Constant key press detected	Touch screen inoperable.	Continual pressure of the touch screen.	Damaged touch screen / touch screen depress for more than 15 seconds.	Display error message until touch screen press released.	Clean touch screen and overlay. Reset power to oven.

Table 3.7: Error codes and actions

Note: To reset the error, cycle the main power button at the front of the appliance.

Error code for recommission test messages

- 89 Cooling test fail – if this occurs repeat test and ensure the test is complete
- 90 Convection test fail – if this occurs repeat test and ensure the test is complete
- 92 Heater test fail – if this occurs repeat test and ensure the test is complete
- 93 Magnetron test fail – if this occurs repeat test and ensure the test is complete
- 96 Door closed test fail – if this occurs repeat test and ensure the test is complete
- 97 Door open test fail – if this occurs repeat test and ensure the test is complete
- 98 Incomplete cleaning – if this occurs repeat test and ensure the test is complete



3D. Tests



All service engineers must familiarize themselves with the information in *Section 1: Safety*, before using this Service and Repair Guide to carry out tests.

Test types

The following tests can be performed by service engineers:

- Components test with a Portable Appliance Tester (PAT)
- Microwave power test
- Microwave leakage test
- Temperature Control test
- Soak test
- Recommission test
- Main voltage test

Equipment required for tests

- Portable Appliance Tester (P.A.T.)
- Digital Multi-Meter (D.M.M.)
- Microwave detection / leakage meter
- Temperature reader
- Continuity meter
- Door Spacer Kit (4mm) part number PSA1109
- Microwave safe 600 ml glass beaker
- Microwave safe 2 liter container



Testing selected components (casing mounted)

Microwave Power test: Measuring the microwave power output of the magnetron(s)

⚠ WARNING Check and ensure that the appliance is cool before starting this test.



The power output is established under IEC 705 standard method which is only workable in laboratory controlled conditions. The power output is also affected by line voltage under load, so this test is an approximation only.

1. Enter Service Mode. For details on how to access the Service Mode see *Entering Service Mode* in *Section 3B*.

2. Select 'Visual View' to check the cavity temperature reading has dropped to as close to 0°C as possible. In most situations this will be room temperature.

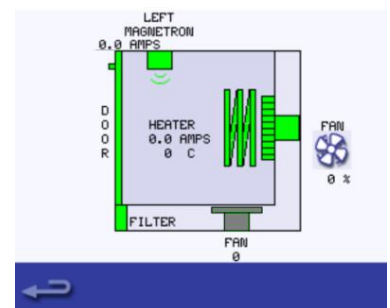
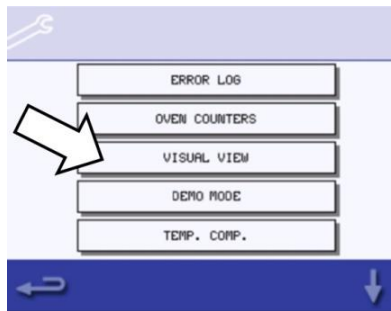

3. Fill a microwave safe container (glass or plastic) with one liter (approx. 2 pints) of tap water at 20°C (68°F) and measure and record the water temperature.

4. Place the container centrally into the cavity and close the appliance door.

5. Select 'Microwave Power Test' from the Service Mode tests screen (microwave power 100% for 60 seconds, fan minimum). The test will start running and count down will begin on screen.

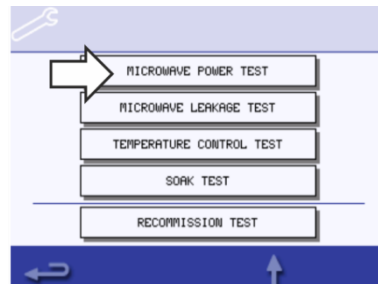

6. When the countdown has finished, remove the container from the cavity. Immediately stir with a plastic implement and measure the water temperature.

7. Calculate the temperature rise of the water (end temperature minus the start temperature).

The temperature rise should be approximately 11°C (52.7°F) ±10% for the 800W. If the temperature rise is considerably outside these limits check the microwave circuit and components.

It may be necessary to replace the magnetron and/or high voltage diode board / rectifier. These procedures are described in detail in *Section 3F*.



Microwave Leakage test

Follow these instructions when measuring:

- Make sure that the survey meter you are using has been calibrated and is suitable for measuring frequencies of 2,450 MHz.
- Do not exceed meter full scale deflection. The leakage meter should initially be set to the highest scale, then adjusted down as necessary to ensure that low readings are measured on the most sensitive range.
- To prevent false readings, hold the probe on the grip provided and move at 2.5 cm/second.
- Always hold the probe at right angles to the oven and point of measurement, ensuring the probe is reading 50 mm from the test area.
- The leakage should not exceed 5 mW/cm².

1. Add 275ml of cold water into a 600ml microwave safe container and place it in the centre of the cavity. Then close the appliance door.

2. Enter Service Mode on the screen and select 'Microwave leakage test' from the appliance tests.

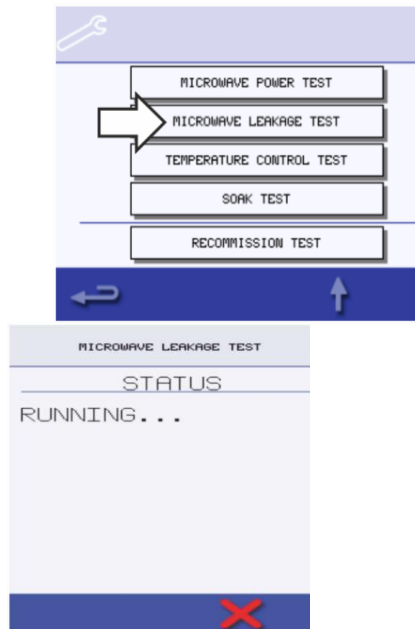

3. Set the leakage meter to the appropriate scale/range.

Move the survey meter probe across all casework joins and vent areas including those marked in yellow.



4. When the magnetron circuit stops after 30 seconds, change the water and re-select the test to continue.

5. Select the red 'X' on the status screen to stop the test at any time.

6. Readings must be below 5 mW/cm² to pass the microwave leakage test.

Any leakage that is observed in terms of the level and position on the appliance should be recorded and kept with the appliance user documentation.

⚠ CAUTION If a level greater than 5 mW/cm² is observed, check for damage to door, door seals, panel work and replace as necessary, then re-test. If not resolved, contact your local Merrychef representative. Don't use the appliance hereafter.

Temperature Control test: measuring the cavity temperature



Re-calibrating the temperature sensor / thermocouple with the SRB is normally only required when the thermocouple has been replaced or the appliance is under or over cooking.

1. Place the probe of a temperature reader on the metal plate in the centre of the oven cavity and close the door.



2. Select 'Temperature Control Test' from the service mode tests.
The cavity heats up and cycles at the maximum set point temperature over 30 minutes.
Once the appliance is up to maximum temperature, check for a stable temperature reading.
Select the red 'X' from the status screen to finish the test, if necessary.

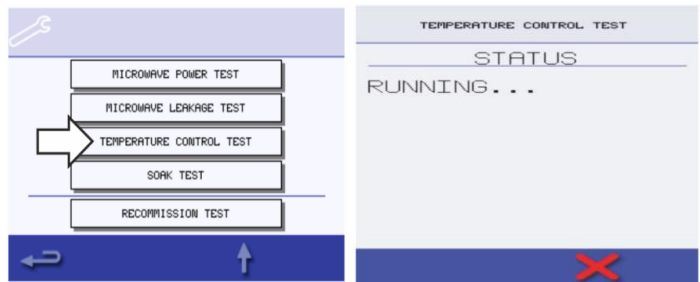

3. If the temperature reading is different to the maximum set point, scroll up to select TEMP. COMP. (Temperature Compensation) and enter the password "TCOMP".

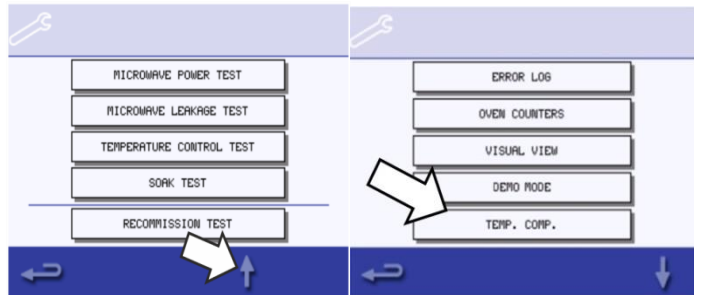

4. Enter the figure from the temperature reader on the keypad and select OK to calibrate the SRB to the temperature sensor (thermocouple).

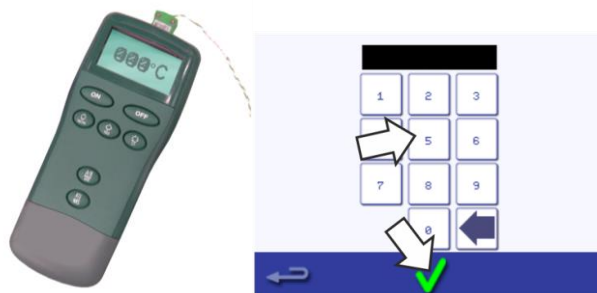

5. Retest to check that the cavity temperature reading is the same as the oven maximum set point temperature.
6. If the temperature reading is stable, repeat the Temperature Control Test procedure.



If the temperature reading is unstable:

1. Disconnect and isolate the appliance from the electricity supply.
2. Take protective measures to ensure the power cannot be switched on again.
3. Allow the appliance to cool down.
4. Remove the side and top panels of the casing.
5. Check the cavity temperature sensor wire and connections.
6. If the wire and connections are working properly replace the cavity temperature sensor (see *Section 3F. - Replacing components*).
7. Refit the panels of the casing.
8. Switch ON the appliance and repeat the test procedure as described above.
9. If the temperature is still unstable repeat steps 1 to 3, replace the SRB (see *Section 3F. - Replacing components*) and repeat step 6.



Reuse the existing PM (Personality Module) on the new SRB (enter serial number on reboot).

Soak test: checking the cavity integrity

The Soak test is used to check the overall functionality of the oven while in full operation.

1. Place an oven/microwave safe container with approximately 2 liters of water into the cavity.
2. Close the appliance door and select 'Soak Test' from the Service Mode oven tests.

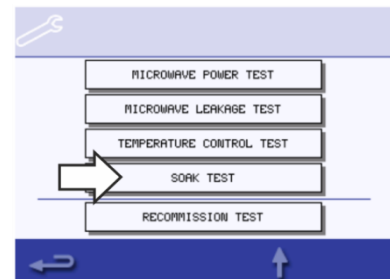

3. Run the test (30 minutes at maximum oven temperature, 50% microwave power, and maximum fan speed), carefully checking the appliance casing, joints and door seal for signs of steam or water escaping from the cavity.

If necessary, rectify any leaks and repeat the test.

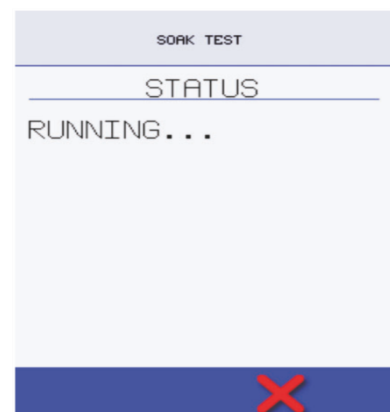

4. Safely remove the container from the cavity.



Recommission test

The Recommission Tests are performed following the completion of a service or repair to ensure that the appliance is working correctly before handing back to the customer. It is not necessary to perform this test upon initial installation.

Some of the tests have a countdown timer where failing to carry out a test within the time limit will cause a test failure and the Recommission Test will have to be restarted.

1. Enter Service Mode. For details on how to enter Service Mode, see *Entering Service Mode* in Section 3B.
Select 'Recommission Test' from the Service Mode oven tests and follow the on screen instructions to perform the tests.

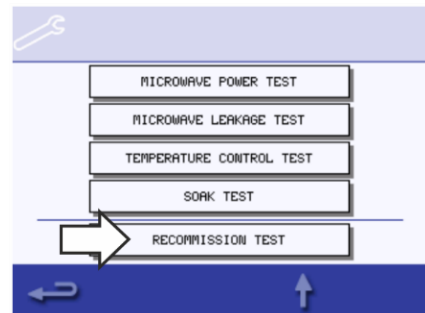

2. The test will begin with countdown. Do not select the red 'X' unless you want to stop the test.

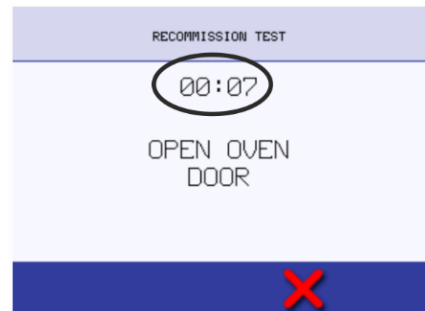

3. After a test has successfully passed, select the green checkmark to continue.

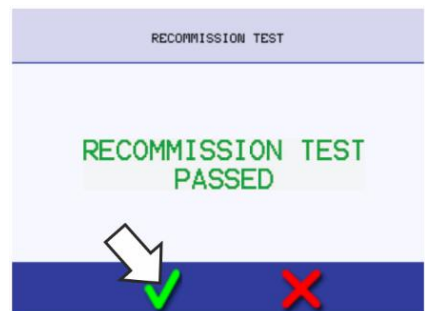

4. When all the tests have been successfully performed the display shows the Recommission Test has passed. Select the green checkmark to confirm.
5. In the event of a Recommission Test failure, the detail will be recorded in the Error Log. Rectify any error and repeat the Recommission Test.



Commissioning the oven after service/repair/testing

Complete the following checks after the oven has been serviced/repared/tested before connecting to the mains electricity power supply:

1. All internal electrical connections are correct (see *Section 3G*).
2. All wiring insulation is correct and is not touching any sharp edges.
3. All grounding connections are electrically and mechanically secure.
4. All door safety microswitches are secure and mechanically sound.
5. The door activates all of the door microswitches and in the correct order.
6. The door operation is smooth, and the arms run freely in the slots.
7. The temperature sensor (thermocouple) is correctly connected to the SRB.
8. The casing is securely refitted with no trapped wires.

Before finishing a service call, recheck the following points:

1. Run the recommission tests to ensure the oven is functioning correctly and the touch screen is working.
2. Microwave emissions are below the permissible limit of 5 mW/cm².
3. The power output of the oven is checked in accordance with the procedure.
4. The oven has a correct air gap of 50 mm / 2 inches above. Air flow should not be restricted.
5. Complete the service report.

High voltage components (casing removed)

High Voltage Transformer test

Ensure the following requirements have been met before starting the test:

- The appliance has been disconnected from the power supply and protective measures have been taken to ensure the power cannot be switched on again.
- The appliance is cool.
- The high voltage capacitors are discharged before commencing work.
- Anti-static precautions have been taken.
- The casing of the appliance has been removed.

⚠ DANGER

- High voltages and large currents are present at the high voltage capacitor.
- It is very dangerous to work near this part when the oven is on.
- NEVER make any voltage measurements at the high voltage circuits, including the magnetron filament.

1. Remove all connections from the transformer.
2. Using a Digital Multi-Meter (DMM), check the resistance of the windings.

Results should be as follows:

- Mains winding between tags, approx. 0.6 – 1 Ω .

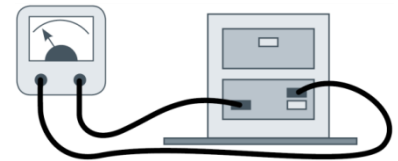

- High Voltage winding, approx. 60 Ω .



- Filament winding between terminals, less than 1 Ω .
It is possible to make this test across the orange cables of the magnetron.

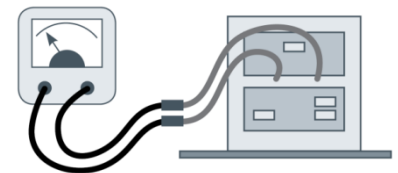

3. Using the DMM, test the insulation resistance between:
 - Primary winding and chassis. Pass if reading is over 10 M Ω
 - Filament winding and chassis. Pass if reading is over 10 M Ω

Note: One end of the High Voltage winding is connected to the chassis, so this is not tested.

High Voltage Capacitor test

Ensure the following requirements have been met before starting the test:

- The appliance has been disconnected from the power supply and protective measures have been taken to ensure the power cannot be switched on again.
- The appliance is cool.
- The high voltage capacitors are discharged before commencing work.
- Anti-static precautions have been taken.
- The casing of the appliance has been removed.

⚠ DANGER

- High voltages and large currents are present at the high voltage capacitor.
- It is very dangerous to work near this part when the oven is on.
- NEVER make any voltage measurements at the high voltage circuits, including the magnetron filament.

1. Remove all electric connections from the high voltage capacitor.

2. Using a Digital Multi-Meter (DMM), check for continuity:

Results should be as follows:

- Connect the DMM to both terminals of the high voltage capacitor.
- The test is passed if the DMM display reaches approx. 10 MΩ.

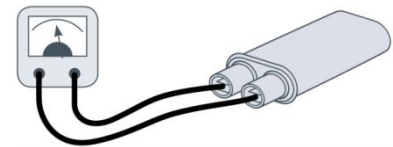

- Connect the DMM to one terminal and the metal outer case of the high voltage capacitor.
- The test is passed if the DMM display reads "open circuit".
- Repeat the test for the other terminal and the metal outer case.

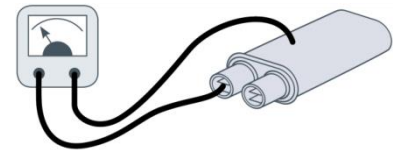

- Using the DMM, test the insulation resistance between both terminals and the metal outer case of the high voltage capacitor.
- The test is passed if the megger display reads over 100 MΩ.

High Voltage Magnetron test

Ensure the following requirements have been met before starting the test:

- The appliance has been disconnected from the power supply and protective measures have been taken to ensure the power cannot be switched on again.
- The appliance is cool.
- The high voltage capacitors are discharged before commencing work.
- Anti-static precautions have been taken.
- The casing of the appliance has been removed.

1. Remove all electric connections from the magnetron.

2. Using a DMM, check for continuity.

Results should be as follows:

- Connect the DMM to both filament terminals of the magnetron.
- The test is passed if the megger display reads 1 Ω or less.

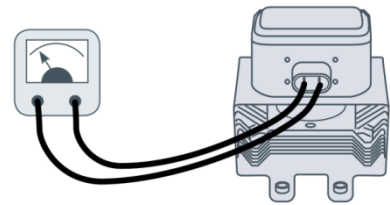

- Connect the DMM to one filament terminal and the metal outer case of the magnetron.
- The test is passed if the megger display reads "open circuit".
- Repeat the test for the other filament terminal and the metal outer case.

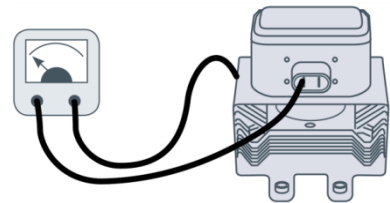

Mains voltage components (casing removed)

Convection fan: motor

The convection fan motor is a 3-phase AC motor having a maximum speed of 5000 rpm controlled by a motor speed controller.

The windings are thermally protected and in the event of a thermal fault, a trip inside the motor will operate and shut down the motor speed controller.

Convection fan: motor speed controller

The convection motor speed controller provides a 3-phase AC switched mode drive to the convection motor and is controlled by a 0 - 10 VDC signal from the SRB.

This allows the motor to be adjusted from approximately 1100 rpm to 5000 rpm in steps of 1%.

- Door open 1100 rpm (20% @ 2V).
- Door closed (not cooking), 1600 rpm (30% @ 3V).
- Door closed (cooking), speed as specified by program or setting up to a maximum of 5000 rpm (100% @ 10V).

Convection fan: LED status display

During normal operation the convection fan LED should be ON and NOT flashing. In an error state the LED will flash and the convection fan will operate in safe mode (limited to 1500 RPM). The number of flashes per second indicates the current error state which are summarized in the table below.

Once the condition that caused the error state has been resolved, the LED will take 10 seconds to recover.



LED flashes	Warning Type	Warning Condition	Recover Condition
1	Over voltage	Input power voltage >270V	Input power voltage < 238V
2	Under voltage	Input power voltage < 150V	Input power voltage > 160V
3	Software over current	More than 9A	Less than 9A
4	Motor over temperature	Temperature fuse open	Temperature fuse recover
5	IPM over current	Current more than 9A	Less than 9A
8	Hardware over current	Current more than 13A	Less than 13A

Table 3.8: Error causes and LED

Convection fan: motor and motor speed controller tests

Ensure the following requirements have been met before starting the test:

- The appliance has been disconnected from the power supply and protective measures have been taken to ensure the power cannot be switched on again.
- The appliance is cool.
- The high voltage capacitors are discharged before commencing work.
- Anti-static precautions have been taken.
- The casing of the appliance has been removed.

Check the following:

- Electrical supply into motor controller.
- Three phase connections to convection fan motor.
- Motor speed controller (convection fan) connections to SRB.
- Convection fan motor thermal cut-out (short circuit).
- Convection fan motor rotates freely / not seized.
- Convection fan motor winding resistances:
 - Red to Green 6-7 Ω
 - Red to Yellow 6-7 Ω
 - Green to Yellow 6-7 Ω
- Red or Green or Yellow to Earth (open circuit).

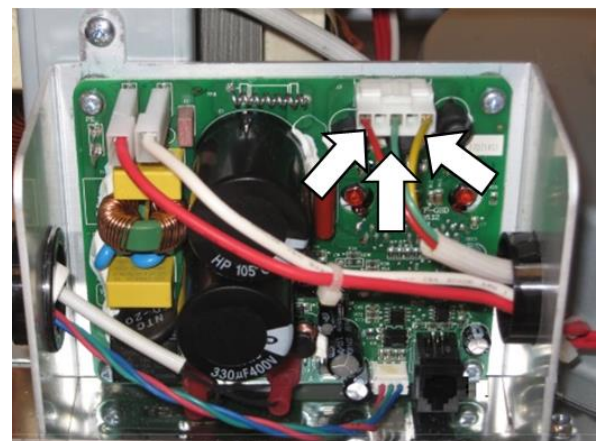

3E. Firmware updates

There are three firmwares required for the e1s: QTS, SRB and Icon. All firmwares are pre-installed but may require updating as per instruction from the manufacturer or as part of hardware replacement. Firmwares are updated by loading the required files to a USB memory stick and then downloading this information to the appliance using the USB memory stick slot on the oven.

Procedures to load USB sticks and download to appliance

Important notes:

- Downloading from a USB memory stick will clear all existing programs.
- Only use an empty USB memory stick (up to 128GB) formatted as FAT32.
- Copy the following firmware files to the ROOT directory of the USB memory stick:
 - QTS-eX-XXX-VX.X.XX.BIN
 - SRB-eX_X_X_XXX.BIN
 - VX-APP-eX.CBR (icon file)
 - Autoupd.ATE (for auto update only)
- The USB memory stick should be formatted to FAT32 with firmware loaded.
- Do not remove the USB memory stick during the download sequence as this could corrupt the data transferred from the USB stick.
- Save the menu files before uploading files.
- If you have a menu file on your USB memory stick then the menu of the appliance will be overwritten.
- If you do not have file on your USB memory stick the menu of the appliance stays as it is.

There are two methods for installing firmwares: manual or automatic. Automatic is the simplest method as it ensures that all three firmwares have been updated at the same time. Manual update is used when one or other of the circuit boards has been replaced.

For manual update follow all instructions in the *Manual updates* section given below.

For automatic update ensure the Autoupd.ATE is on the USB memory stick then follow the instructions in the *Automatic updates using Autoupd.ATE files* section.

Manual updates

1. With the oven switched off, open the cover of the USB port and insert the USB memory stick into the slot.

The USB memory stick should be formatted to FAT32 with firmware loaded.

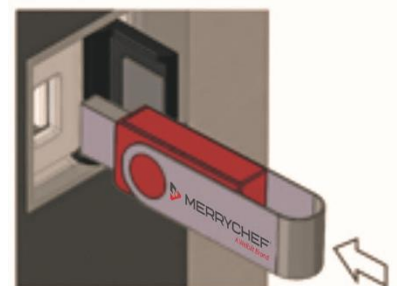

2. Switch on the oven and tap the top-right hand corner.



3. Enter the password and select the green checkmark.



4. Select the USB symbol from the Settings menu.



5. Select from the USB screen 'Firmware' (for QTS and SRB updates).



6. Install updates by selecting the correct files.

Updates should be installed in this order:

1. SRB update – see below for instructions
2. QTS update – see below for instructions

The update screen will display the file version and product. Select the green checkmark to confirm the installation.



SRB firmware update

1. When you select Firmware, the current QTS (Quick Touch Screen) and SRB (Smart Relay Board) firmware versions are displayed at the top left of the screen. Select the 'SRB' file with the correct file version number.

Note: A tinted band over a file name indicates the file is not valid for your oven.

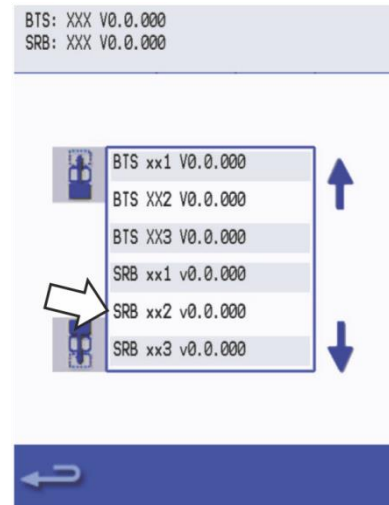

2. Check if the file information shown is correct before selecting OK. If not, select 'X' and locate the correct file.

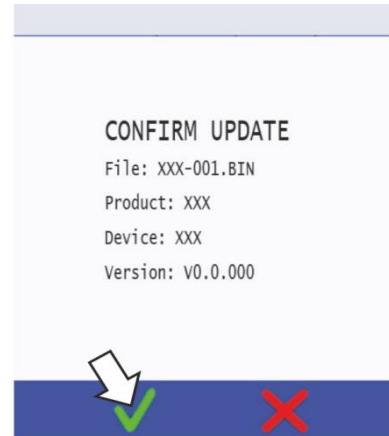

3. The SRB file is checked and the download progress from the USB is displayed followed by the update status and confirmation screens.

Note: Wait until all files have been loaded. Do not touch the oven until the end of the downloading process.



4. When the download process is complete, press the return arrow to now update QTS file.



QTS firmware update

1. Select the 'QTS' file with the correct file version number.

Note: A tinted band over a file name indicates the file is not valid for that appliance.

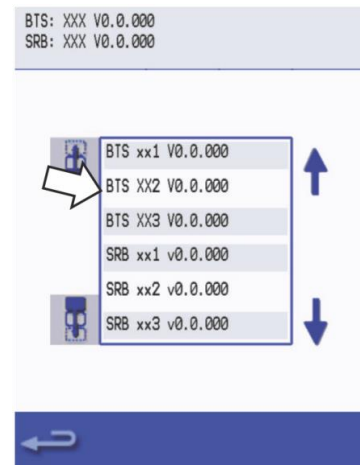

2. Check if the file information shown is correct before selecting OK.
If not, select 'X' and locate the correct file.



3. The file update progress is displayed.
When the QTS download has been completed, the oven will reboot and display a flash screen as it updates.
At 50%, the cooling fan stops operating, after 100% various screen displays appear as the software reboots.

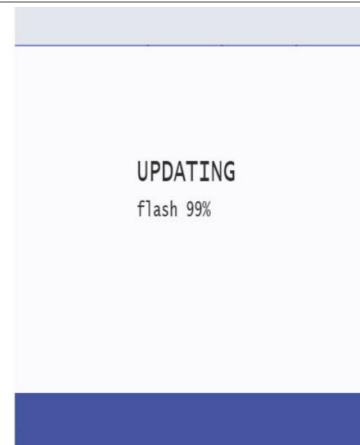

4. Once rebooted, check if the screen shows the correct QTS version.
If not, repeat the process using the correct file.



5. Remove the USB memory stick and keep it in a safe place.



Automatic updates using Autoupd.ATE files

1. Load the USB stick with the Autoupd.ATE file.
Copy the following firmware files to the ROOT directory of the USB memory stick:

- QTS-eX-XXX-VX.X.XX.BIN
- SRB-eX_X_X_XXX.BIN
- VX-APP-eX.CBR
- Autoupd.ATE

With the oven switched OFF, open the cover of the USB port and insert the USB memory stick into the slot.

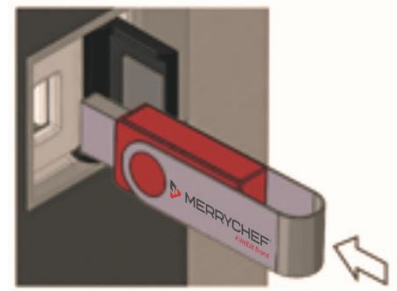

2. Switch ON the oven.

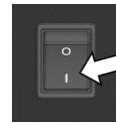

3. Tap the top right of the screen to bypass the preheat stage.



4. Enter the password "MANAGER" and select OK to display the settings menu.



5. Select the USB symbol.



6. Select the 'Firmware to Oven' USB symbol.



7. The file starts downloading. The CBR file is checked and the download progress from the USB memory stick is displayed followed by the update status and confirmation screens.

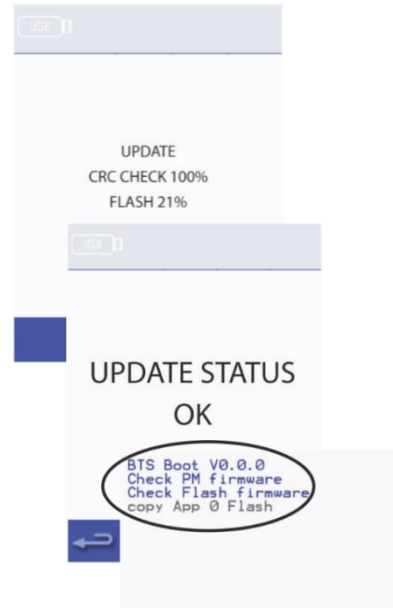

8. The QTS, SRB and Application Icon files then download automatically showing the progress, status and reboot confirmation screens for each file update.

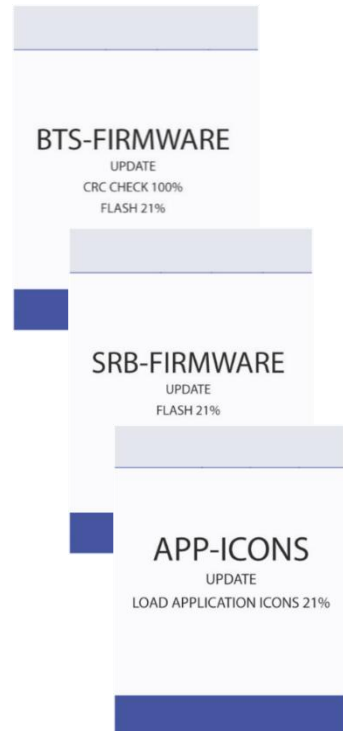

9. On completion, the start up screen is displayed showing the updated firmware versions before moving to the pre-heat temperature screen.



Confirming the firmware update

After an update of the appliance firmware certain files are copied back to the USB memory stick.

You can check if the file transfer was successful with the following procedure:

1. Load the files from the USB memory stick to a computer.
2. Open the update (UPDATE.txt) file.
3. A firmware update is confirmed below the serial number of the appliance with 'updated' following the QTS/SRB firmware.

Load only the specific files for the stage 4.x upgrade onto the USB memory stick:

- BTS/QTS - (model type) V.004.000.xxx
- SRB - (model type) V.004.000.xxx
- Latest menu file xxxxxxxxxx



Load only the correct menu files onto the USB memory stick and not single menus.

PM (Personality Module) replacement - firmware update

The Personality Module on the SRB contains the firmware.

The Personality Module on the QTS contains the firmware, serial number of your appliance, temperature calibration, cooking profiles, application icons and the recipe images.

1. With a new Personality Module fitted and casing refitted, switch on the appliance and tap the screen to hold and check the QTS and SRB versions are the latest release.

If not, execute a firmware update using the latest versions.



2. Tap the top right of the screen to bypass the preheat stage.



3. Enter the service password "MANAGER" and select OK to display the settings menu.



4. Select the USB symbol.



5. Open the cover to the USB port and insert the USB memory stick into the slot.

Note: The USB memory stick may take several seconds to load before the screen will respond. Do not remove the USB memory stick until the process is complete.

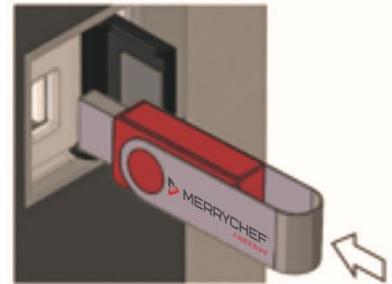

6. Once the USB memory stick has stopped flashing, select the 'Menu to Oven' symbol.



7. Select the application icons file to download.

Note: A tinted band over a file name indicates the file is not valid for that appliance.

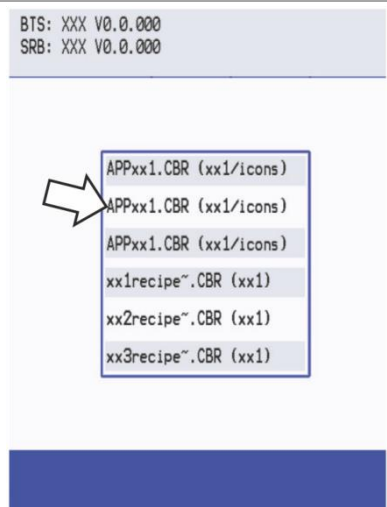

8. Check the file information shown is correct before selecting OK.
If not, select 'X' and locate the correct file.

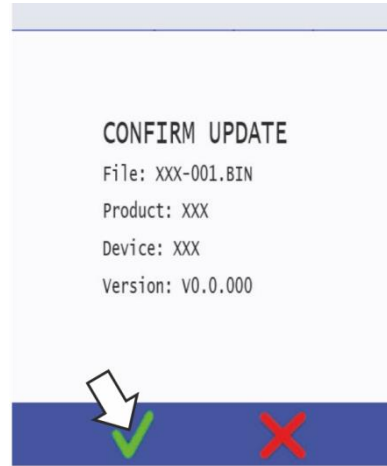

9. When completed, select menu file to load the cooking profiles.
Once the cooking profiles are loaded the appliance restarts.



10. Enter the date and time settings.



11. Enter the serial number of the appliance (found on the rating plate at the rear casing).



12. Switch the appliance OFF/ON.

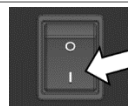

13. Remove the USB memory stick and keep it in a safe place.



3F. Replacing components

Safe working when replacing appliance parts



All service engineers must familiarize themselves with the information in *Section 1: Safety*, before using this Service and Repair Guide and carrying out tests.

Before starting service / repair work, it is essential that you familiarize yourself with all the rules and hazard warnings specified and follow the instructions given.

Eligibility of personnel for removal / fitting of appliance parts

Only qualified personnel from an authorized service company are permitted to remove and fit components of the microwave combination oven.

Rules for setting up the appliance safely

To prevent hazards that arise from the installation site and environment of the appliances, the rules for setting up the appliance safely must always be observed. See *Section Error! Reference source not found.*

Moving heavy loads



Risk of injury from lifting incorrectly

When lifting the appliance, the weight of the appliance may lead to injuries, especially in the area of the torso.

- Use a forklift truck or pallet truck to place the appliance in the installation position or to move it to a new position.
- When shifting the appliance into the correct position, use enough people for the weight of the appliance when lifting it (value depending on age and gender). Observe the local occupational safety regulations.
- Wear personal protective equipment.

Sharp-edged sheet-metal parts



Risk of cuts from sharp-edged sheet-metal parts

Working with or behind sharp-edged sheet-metal parts may result in cuts to hands.

- Exercise caution.
- Wear personal protective equipment.

Hot surfaces



Risk of burns from high temperatures inside the cavity and on the inside of the appliance door

- You may get burnt if you touch any of the interior parts of the cooking chamber, the inside of the appliance door or any parts that were inside the oven during cooking.
- Before starting servicing and repair work, wait until the cooking chamber has cooled to below 50°C / 122°F or use the 'Cool-down' function to cool the cooking chamber.
- Wear personal protective equipment.



Live components

DANGER

Risk of electric shock from live parts

When the covers of the microwave combination oven are removed, there is a risk of electric shock from touching live parts.

- Make sure that any work on the electrical system is performed solely by a qualified electrician from an authorized customer service office.
- Before removing the covers:
 - Switch the appliance off and disconnect the plug from the wall socket.
 - Turn off the isolator switch to disconnect fixed wired appliances and lock-off.
 - Take protective measures at every power switch to ensure that the power cannot be switched on again.
 - Always discharge the high voltage capacitors before working on the appliance using a suitably insulated 10MΩ resistor.
 - Make sure that the appliance is de-energized.
- Make sure that the electrical connections are intact and connected securely before you reconnect the appliance to the power supply.
- Before putting the appliance back into operation, make sure that the appliance, including all metallic accessories, is connected to an equipotential bonding system.

When the appliance is not connected to an equipotential bonding system, there is a risk of electric shock from touching live parts.

- Make sure that any work on the electrical system is performed solely by a qualified electrician from an authorized service company.
- Make sure that the electrical connections are intact and connected securely before putting the appliance into use.
- Before preparing the appliance for use, make sure that the appliance, including all metallic accessories, is connected to an equipotential bonding system.

Microwave emissions

WARNING

Risk of burns from microwave emissions

- Do not become exposed to emissions from the microwave generator or parts conducting microwave energy.
- Never operate an appliance that has failed the Microwave Leakage test.

Fire / smoke in the appliance

WARNING

Risk of fire and/or smoke

Flames and/or smoke may come out of the oven when switching it on after service/repair. This can be caused by a defective electrical component or electrical connections (wiring) that have been refitted incorrectly.

- Switch off the oven.
- Disconnect/isolate the oven from the electrical supply.
- Keep the oven door closed to stifle any flames.



Overview of parts

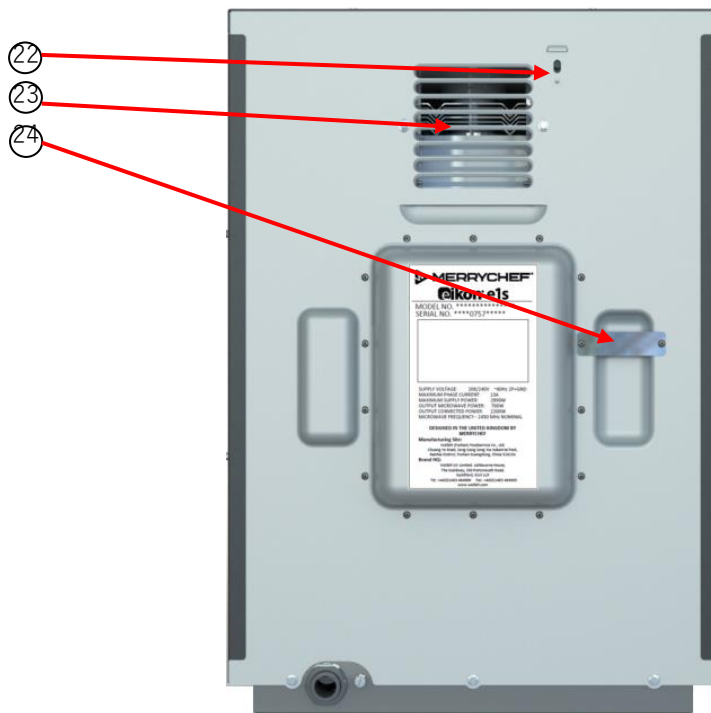
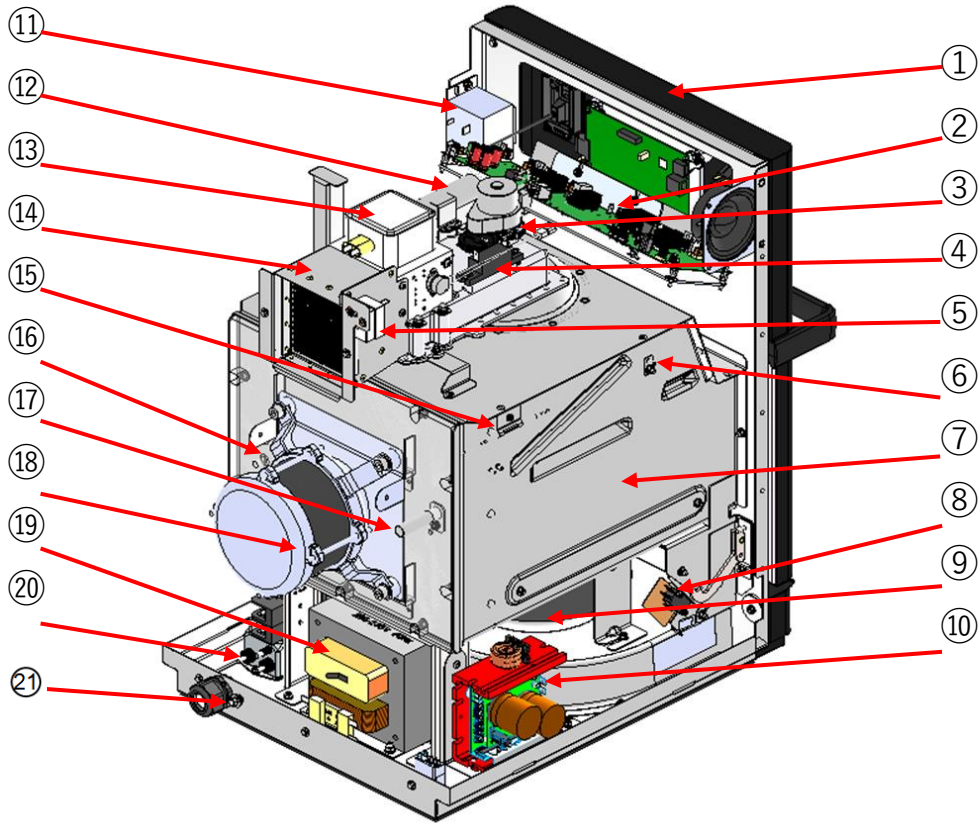

 The exact position of the parts and components may vary depending on the version of the oven that you have purchased.



Component List

Item	Name	Function
1	Front panel	The front panel houses the touch screen and the QTS assembly.
2	Smart Relay Board (SRB)	The SRB controls all electrical oven components.
3	Stirrer Motor	A stirrer motor turns a stirrer distributing microwave energy in the cavity.
4	Diode (high voltage)	The diode completes the magnetron circuit for required high voltage.
5	Cavity Thermostat	The thermostat continuously measures the temperature in the cavity and prevents it from overheating. A reset button is found on the thermostat rear which is accessible through the rear panel (see Item 22).
6	Cavity temperature sensor wire (thermocouple)	The sensor wire extends between the thermostat and the interior of the cavity.
7	Cavity	The cavity (cooking chamber) for cooking food can be accessed by opening the oven door.
8	Door microswitch(es)	The microswitches are connected to the door hinges and switch off the magnetron(s) when the oven door is opened.
9	Cooling fan	The cooling fan pulls air through the air filter into the interior of the casing in order to cool the electrical components.
10	Convection (hot air) fan motor speed controller	This component controls the speed of the convection fan motor depending on specific oven settings.
11	Transformer (low voltage)	The low voltage transformer feeds the SRB.
12	Capacitor (high voltage)	The capacitor completes the magnetron circuit for required high voltage.
13	Magnetron (high voltage)	A magnetron generates microwaves.
14	Cooling duct	The cooling duct leads heat generated by the magnetron(s) to the rear of the oven.
15	Overheat sensor	Used by the cavity thermostat to detect overheating.
16	Element	Heater element.
17	Exhaust pipe	The exhaust pipe leads excessive steam from the cavity to the cooling duct and the rear air outlet of the oven.
18	Convection (hot air) fan motor	The convection fan motor is controlled by the speed controller and drives the convection fan.
19	Transformer (high voltage)	A high voltage transformer feeds a magnetron.
20	Electromagnetic Compatibility (EMC) Filter and Fuses	EMC filters reduce the transfer of electromagnetic noise. The fuses protect the oven from high voltages and currents.
21	Equipotential bonding connection (CE appliances only)	This is an electrical connection that ensures that the frames of electrical equipment and any external conductive components are at an equal (or practically equal) potential.
22	Cavity thermostat reset button	Press to reset a cavity overheat.
23	Air vent grille	Allows air to flow from the magnetron.
24	Exhaust outlet protection	Prevents touching the hot steam outlet.

Table 3.9: Components and their functions



Removing / fitting the casing

Requirements and tools

Check that the following requirements have been met:

- The appliance has been disconnected from the power supply and protective measures have been taken to ensure the power cannot be switched on again.
- The appliance is cool.
- The top, left and right panels of the casing of the appliance have been removed.
- The high voltage capacitors are discharged before commencing work.
- Anti-static precautions have been taken.

Tools required:

- M5.5 hex socket wrench / nut runner

1. Remove the top panel first. Unscrew the four remaining M5.5 screws, then lift the rear of the panel and slide backwards.

Important note: The high voltage capacitor should be discharged once the top cover has been removed.

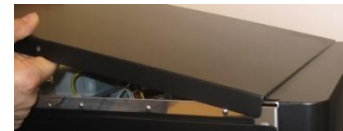
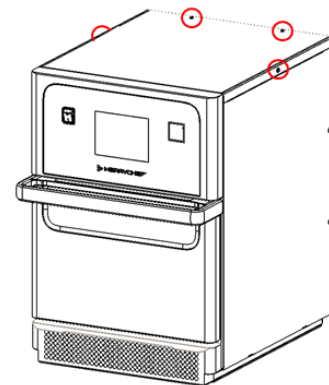

2. To remove the side panels, unscrew the two screws that attach each side panel to the rear panel.

When removing the side panels, lift and move the rear of the panels away from the appliance before sliding backwards.

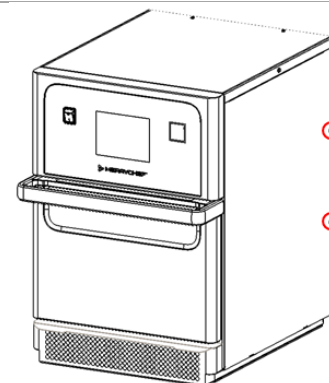

3. To remove the rear panel, first unscrew the three screws at the bottom of the panel and then the two screws either side of the air duct grille.

The panel can then be lifted to remove.

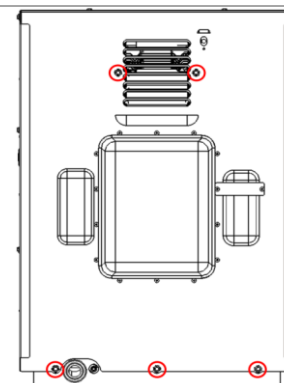

Removing / fitting the door assembly and door seal

Requirements and tools

Check that the following requirements have been met:

- The appliance has been disconnected from the power supply and protective measures have been taken to ensure the power cannot be switched on again.
- The appliance is cool.
- The high voltage capacitors are discharged before commencing work.
- Anti-static precautions have been taken.

Tools required:

- Two metal pins (length: 10 mm / 0.4 in)
- Stanley knife
- Sealant
- Cloth for wiping residue

Unassemble door

1. Open the door fully and locate the holes positioned in the upper area of the hinges.



2. Push the two metal pins through the holes in each hinge.



3. Close the door onto the two metal pins and then free the door by pulling upward and forward. The door should now be fully removed.



Removing and fitting door seal

1. Place a stanley knife underneath the door seal and go all the way to break the seal.
Ensure you do all four sides avoiding the metal clips on each corner.

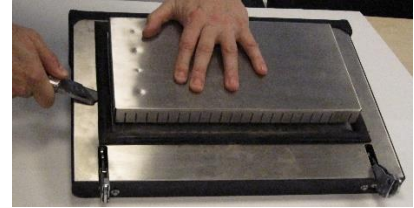

2. Gently pull the metal clip out of each corner and lift off the door seal



3. Remove excess sealant using the stanley knife or similar to make the surface as flat as possible and then clean the inner surface area wiping off any remaining sealant and residue.



4. Apply sealant around the existing door seal area. Ensure you do all four sides.



5. Place the new door seal over the door in the same place as the old one and insert the metal clips in each corner.
Note: You may need to trim the metal clips.

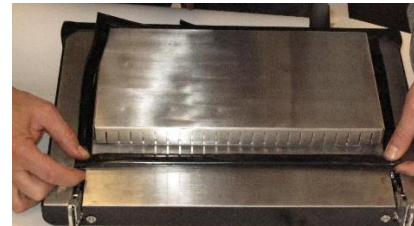

6. Apply sealant underneath the door seal and press down firmly to tightly secure the door seal onto the door. Ensure it is straight and wipe off any excess sealant leaking.



7. Leave to dry naturally. It will need 24 hours to dry but the heat of the oven can also be used to dry the sealant by refitting the door (see below).



The door seal can be replaced without removing the door. Simply open the oven door as much as you can and follow the procedure above.



Refitting the door

1. Keeping the removed door flat at 90 degrees to the oven, push the two metal hinges inside the available slots at the bottom of the oven. You should feel the hinges fitting in place.

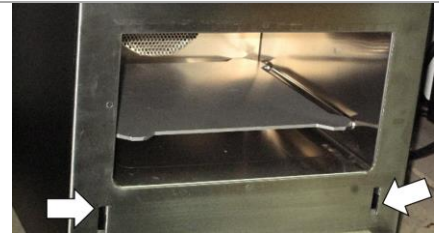

2. Close the appliance door. Re-open and close to check the fitting.
Note: If the door was removed to replace door seal, you can now leave the door closed and let the sealant dry naturally for 24 hours or you can heat up the oven to dry the seal.



Heating up the oven to dry the seal

3. Switch the oven on and let it heat to 260 degrees.
4. Keep the door shut for two hours.
The oven will be ready for usage again after 2 hours

⚠ WARNING

- Never use the oven without the door seal attached properly.
- Never switch on the oven without the door attached and closed.



Replacing a magnetron

Requirements and tools

Check that the following requirements have been met:

- The appliance has been disconnected from the power supply and protective measures have been taken to ensure the power cannot be switched on again.
- The appliance is cool.
- The top, left and right panels of the casing of the appliance have been removed.
- The high voltage capacitors are discharged before commencing work.
- Anti-static precautions have been taken.

Tools required:

- Hammer or similar tool
- PZ2 Pozidriv screwdriver
- M8 hex socket wrench

Component location

The magnetron is located on top of the cavity and is fixed to the cooling duct and the cavity roof.

The cooling duct covers one side of the magnetron where the magnetron is attached to the cavity roof with two screws.

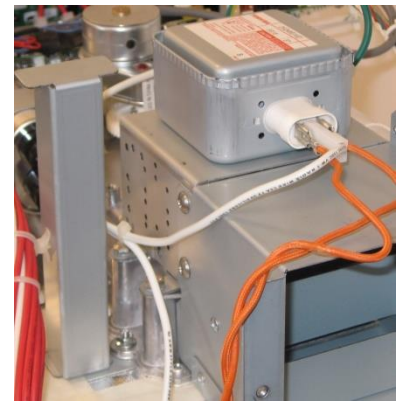

The outlet of the cooling duct carries heat to the back of the oven and is covered by a grille.



The outlet comprises a sheet metal frame.



Preparing a spare magnetron

1. The spare magnetron comes with four pressed bolts. Remove the bolts before fitting the magnetron to the oven.

Note:

- The bolts can be removed by knocking them out of the tabs with a hammer.
- Ensure the tabs do not get bent. Secure them by laying them upon a piece of tube while pushing out the screws.

CAUTION

Wear personal protective equipment to protect your fingers when using the hammer.

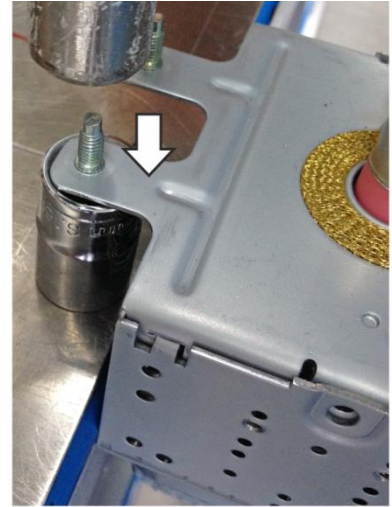

Comparison of spare magnetrons with (right) and without (left) pressed bolts.

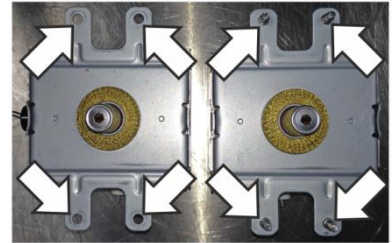

Removing the magnetron

1. Unfasten the pozidriv screws on the right side of the cooling duct.

Unfasten the pozidriv screws on the left side of the cooling duct.

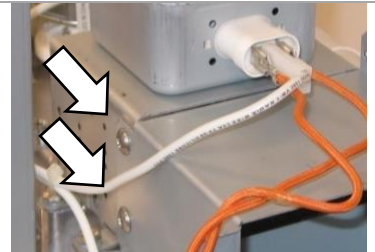
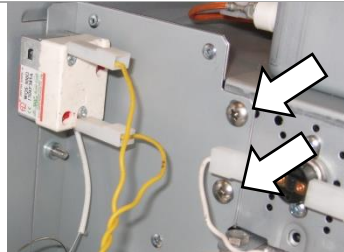

2. Disconnect the orange and white cables from the magnetron body.

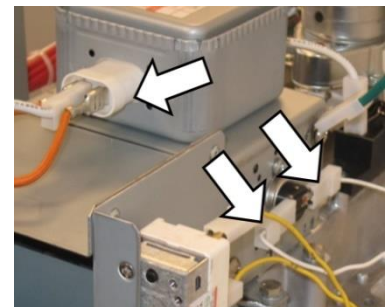

3. Carefully remove the cooling duct so as not to pull on the cables.

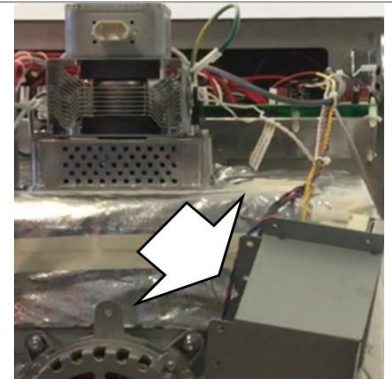

4. Remove the four M8 nuts from the magnetron base.
The magnetron can then be removed by lifting the magnetron body.

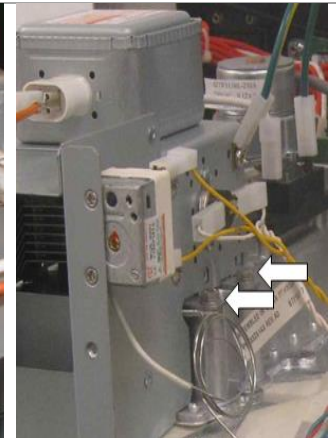
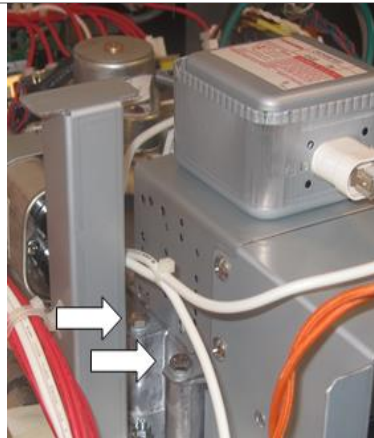

Fitting a magnetron

Follow the steps in the reverse order to fit a spare magnetron.

⚠ WARNING

- Ensure nothing becomes trapped under the magnetron mounting points (e. g. insulation material) while fitting the magnetron. This can lead to microwave leakage.
- If the electric connections have not been restored properly this may lead to malfunction/damage of the oven.



Replacing the cooling fan

Requirements and tools

Check that the following requirements have been met:

- The appliance has been disconnected from the power supply and protective measures have been taken to ensure the power cannot be switched on again.
- The appliance is cool.
- The top and side panels of the casing of the appliance have been removed.
- The cooling fan speed controller is removed.
- The high voltage capacitors are discharged before commencing work.
- Anti-static precautions have been taken.

Tools required:

- M7 hex socket wrench
- PZ2 pozidriv screwdriver

Component location

The cooling fan is located under the oven cavity.

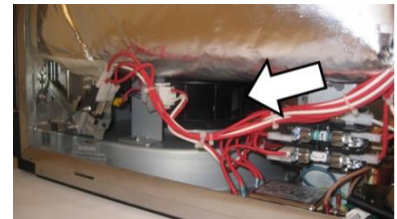

Removing the cooling fan

1. On the right-hand side of the appliance, unplug the electrical connection of the cooling fan.

Loosen the M7 hex nut to free the metal bracket holding the cooling fan.

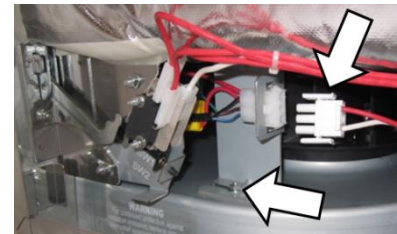

2. On the left-hand side of the appliance, unfasten the PZ2 and M7 nut that hold the convection fan motor speed controller board backing plate.

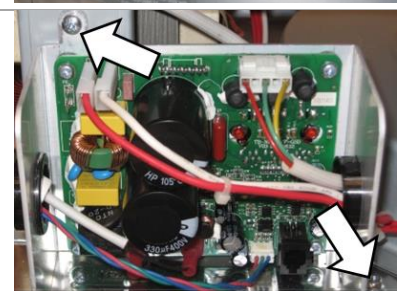

3. Slide the board/backing plate towards the rear of the appliance to provide access to the cooling fan.



4. Unplug the door microswitch connections on the left side of the appliance. Loosen the M7 hex nut to free the metal bracket holding the cooling fan.

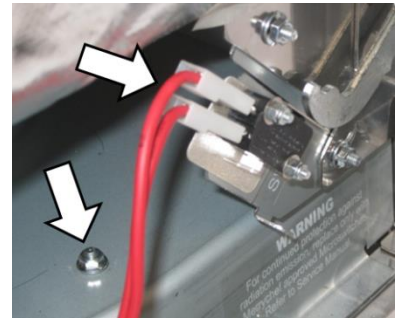

5. The cooling fan can then be removed by lifting upward and sliding out on the left side of the appliance.

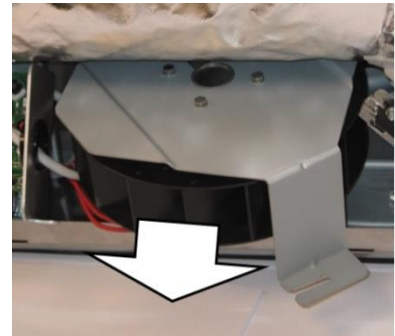

Fitting the cooling fan

Follow the steps in reverse order to fit the cooling fan.

CAUTION

If the electric connections have not been restored properly this may lead to malfunction/damage of the oven.

Replacing the QTS (Quick Touch Screen) assembly

Requirements and tools

Check that the following requirements have been met:

- The appliance has been disconnected from the power supply and protective measures have been taken to ensure the power cannot be switched on again.
- The appliance is cool.
- The top and side panels of the casing of the appliance have been removed.
- The high voltage capacitors are discharged before commencing work.
- Anti-static precautions have been taken.

Tools required:

- M5.5 hex socket wrench

Component location

The QTS (Quick Touch Screen) board lies behind the easyTOUCH® screen and is attached to the front panel of the oven.



Removing the QTS assembly

1. Disconnect all cables connecting the QTS assembly.

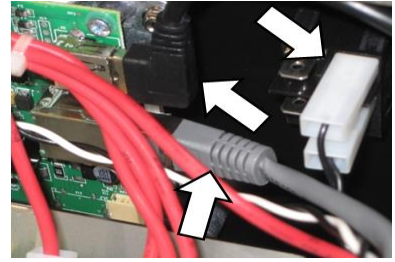

2. Unfasten the M5.5 hex head flange bolt that fixes the front panel to the appliance body.

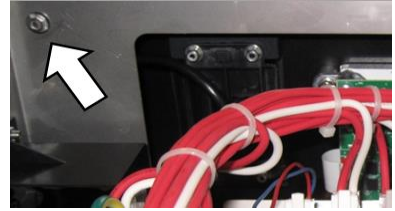

3. Remove the top front panel (including the touch screen and QTS assembly) from the frame of the casing by lifting upward and towards the front of the appliance. Note the three studs in corners of the assembly that locate and hold the assembly to the appliance body.

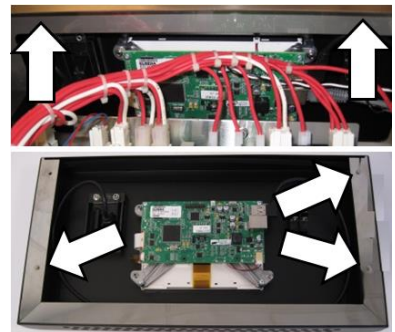

4. Unfasten the four M5.5 hex head flange bolts to remove the QTS assembly from the front panel.

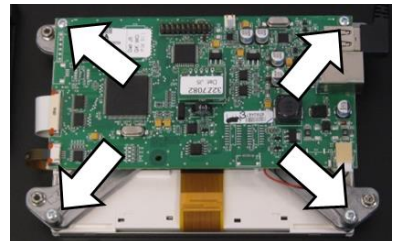

5. Remove the PM (Personality Module) from the QTS and place safely aside.

CAUTION

Do not use tools to remove or refit the Personality Module.

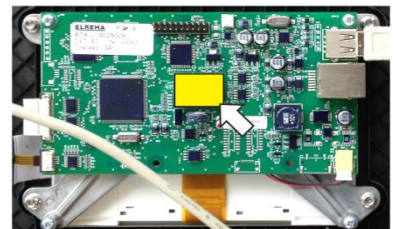

Fitting the QTS assembly

- Follow the steps in the reverse order to fit the QTS assembly.
- Reconnect all electric connections to the QTS board.

Note: Fit the PM removed from the old QTS to the new QTS.

Reason: Replacement QTS units come WITHOUT Personality Modules as they store individual settings saved by the user. For details see QTS circuit board assembly in Section 3G.

CAUTION

If the electric connections have not been restored properly this may lead to malfunction/damage of the oven.



Replacing the SRB (Smart Relay Board)

Requirements and tools

Check that the following requirements have been met:

- The appliance has been disconnected from the power supply and protective measures have been taken to ensure the power cannot be switched on again.
- The appliance is cool.
- The side and top panels of the casing of the appliance have been removed.
- The high voltage capacitors are discharged before commencing work.
- Anti-static precautions have been taken.

Tools required:

- M7 hex socket wrench

Component location

The SRB (System Relay Board) extends over the whole width of the oven and rests in a tilted position close to the front panel of the oven. It is mounted to the frame of the appliance.

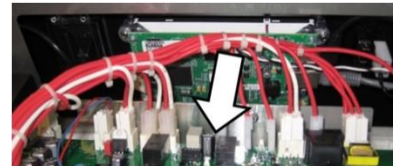

Removing the SRB

1. Disconnect all cables connecting the SRB to other components.



2. Unfasten two M7 hex head flange bolts to remove the SRB from the frame of the casing.

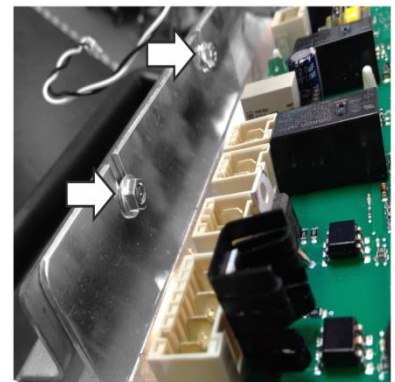

3. Remove the PM (Personality Module) from the SRB and place safely aside.

CAUTION

Do not use tools to remove or refit the Personality Module.



Fitting the SRB

- Follow the steps in the reverse order to fit the SRB.
- Reconnect all electric connections to the SRB.

For details see *SRB circuit board* in *Section 3G*.

- (1) = Thermocouple connector
(2) = Personality Module

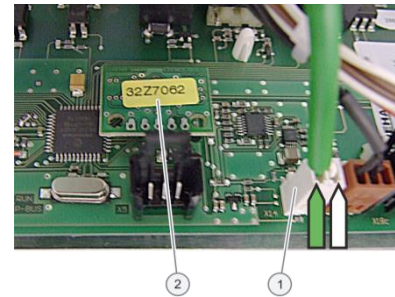

Ensure the thermocouple negative (-) connection (white) and positive (+) connection (green) are fitted the correct way round or the oven temperature readings will be wrong.

Note: Refit the Personality Module (PM) removed from the old SRB to the new SRB.

Reason: Replacement QTS / SRB units come WITHOUT Personality Modules as the PMs store individual settings saved by the user.

CAUTION

If the electric connections have not been restored properly this may lead to malfunction/damage of the oven.

Replacing the touchscreen overlay

Requirements and tools

Check that the following requirements have been met:

- The appliance has been disconnected from the power supply and protective measures have been taken to ensure the power cannot be switched on again.
- The appliance is cool.
- The top and side panels of the casing of the appliance have been removed.
- The high voltage capacitors are discharged before commencing work.
- Anti-static precautions have been taken.

Tools required:

- Flat headed screw driver

1. The touch screen overlay surrounds the easyTOUCH® screen providing easy-to-clean protection from electrical connections. Should it fail, it can be removed by prising away from the front of the appliance with a flat headed screwdriver.



2. The adhesive should be removed from the appliance using an alcohol based cleaner before the replacement is applied.

Adjusting the door microswitches

Requirements and tools

Check that the following requirements have been met:

- The appliance has been disconnected from the power supply and protective measures have been taken to ensure the power cannot be switched on again.
- The appliance is cool.
- The top and side panels of the casing of the appliance have been removed.
- The high voltage capacitors are discharged before commencing work.
- Anti-static precautions have been taken.

Tools required:

- M7 hex socket wrench

Component location and importance

Located on the door hinges are three safety microswitches, to prevent microwave emissions escaping when the oven door is opened:

- The primary microswitch (SW3) breaks the electrical supply circuit to the transformers.
- The secondary microswitch (SW2) breaks the microwave circuit if the primary fails.
- The monitor switch (SW1) will short out the microwave circuit blowing the fuse if both primary and secondary microswitches fail.

You should adjust the microswitches after replacing old with new door hinges.

Note: Micro-switch alignment is NOT required if just refitting the same door.

Important note:

In the event that the monitor switch causes the microwave circuit fuse to blow, the secondary (SW2) and monitor (SW1) microswitches must be replaced due to exposure to high short-circuit currents.

The purpose of the following adjustment procedure is to set the microswitch to switch off the microwave circuit when the door is opened more than 4 mm and for the microwave circuit to operate when the door is closed and the door seal expands.

Adjusting the switches

1. Open the appliance door and position the red 4mm spacers over the top corners of the door seal. Then carefully close the door ensuring the spacer is still in position.

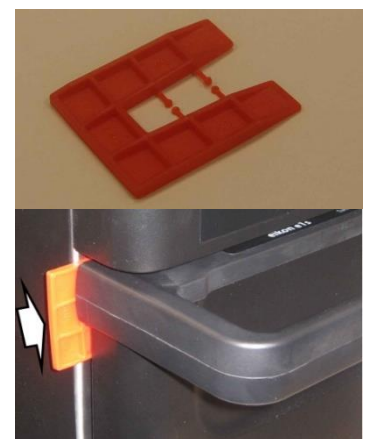

2. Slacken the pivot screw using a M7 hex socket wrench.
3. Release the adjusting screws and move the backplate until microswitch SW3 just activates. Then secure all screws.



4. Open the appliance door to replace the green 2mm spacers with red 4mm spacers and close the door.
5. Slacken the pivot screw using a M7 hex socket wrench.
6. Release the adjusting screws and move the backplate until microswitch SW2 just activates. Then secure all screws.
7. Remove the spacers, then open and close the appliance door 5-10 times.

Important checks

Check if the switches operate in the following sequence, as microswitch SW3 must switch the load current.

Closing the door:

SW1 opens first
SW2 closes second
SW3 closes third

oven door open

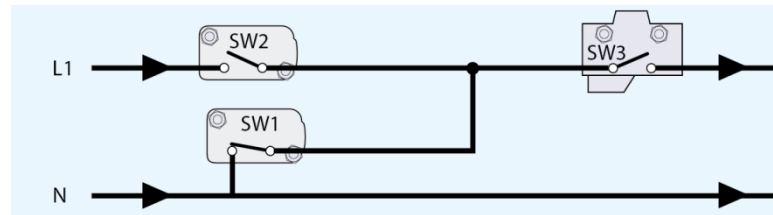

Opening the door:

SW3 opens first
SW2 opens second
SW1 closes third

oven door closed

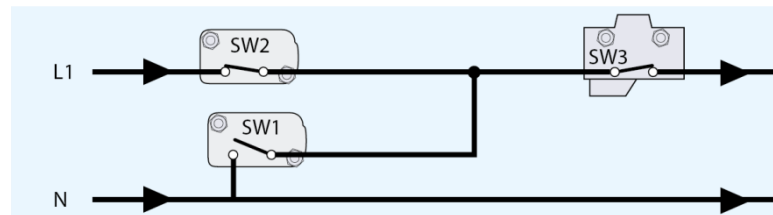

Replacing the impinger plate

Requirements and tools

Check that the following requirements have been met:

- The appliance is cool
- Tools required – none

Removing the impinger plate

1. The impinger plate rests on brackets in the upper part of the cavity.
To assist removal, a larger hole is provided at the front of the impinger plate big enough to insert a finger.

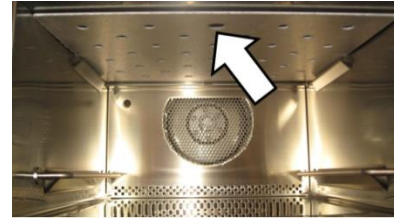

2. Remove the impinger plate from the cavity by pulling forward and slightly downward.

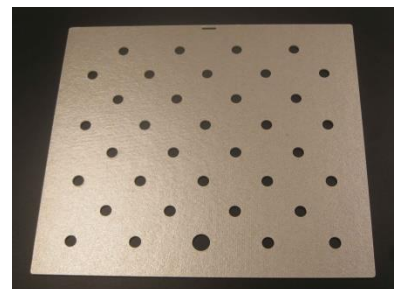

Fitting the impinger plate

The impinger plate is fitted with the reverse action to removal, pushing until the plate slots into place.



Replacing the stirrer

Requirements and tools

Check that the following requirements have been met:

- The appliance has been disconnected from the power supply and protective measures have been taken to ensure the power cannot be switched on again.
- The appliance is cool.
- The upper casing panel of the appliance has been removed.
- The high voltage capacitors are discharged before commencing work.
- Anti-static precautions have been taken.

Tools required:

- M7 hex socket wrench
- Replacement partition plate

Component location

The stirrer is positioned inside the top of the oven cavity. To access the stirrer the impinger plate is first removed (see above).



Removing the stirrer

1. Removing the impinger plate (see above) reveals the partition plate. Unfasten the nine M7 hex nuts that secure the partition plate.



2. The partition plate features a rubber gasket on its upper side which adheres to the upper surface of the cavity.

The rubber gasket prevents grease-laden air from entering the space around the cavity and so needs to be intact.

To remove the partition plate, it is necessary to first prise the gasket from the silver mica board with a flat edge screwdriver. This will compromise the gasket and so a replacement partition plate is required to complete the stirrer replacement procedure.

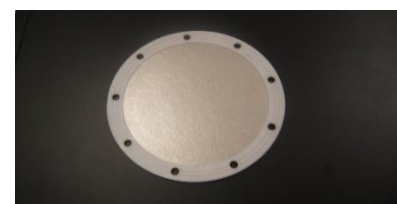

3. To remove the stirrer from the motor spindle, the motor must be prevented from moving. This is most easily achieved by holding one of the white cogs located below the motor.

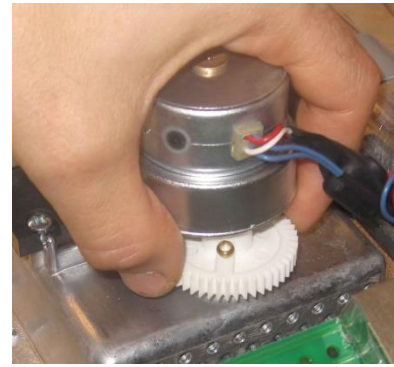

The stirrer can then be removed by turning clockwise.

Remove the remains of the old gasket before fitting the new impinger plate (comes with gasket).

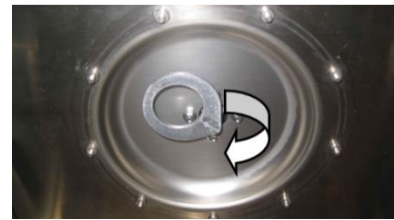

Fitting the stirrer

- Follow the steps in the reverse order to fit the stirrer.
- When refitting the partition plate, fasten the screws on opposite corners/sides in turns and do NOT proceed stringently clockwise or counterclockwise.
- Tighten the partition plate screws to 2.1 Nm of torque.



Replacing the stirrer motor

Requirements and tools

Check that the following requirements have been met:

- The appliance has been disconnected from the power supply and protective measures have been taken to ensure the power cannot be switched on again.
- The appliance is cool.
- The upper casing panel of the appliance has been removed.
- The high voltage capacitors are discharged before commencing work.
- Anti-static precautions have been taken.

Tools required:

- M7 hex socket wrench
- Pozidriv PZ1 screwdriver
- Loctite thread adhesive
- Replacement partition plate

Component location

The stirrer motor is positioned on top of the oven cavity between the magnetron and SRB board. To remove the motor, the stirrer must first be freed from the motor spindle inside the cavity. To do this, the impinger plate and stirrer are removed as described above.

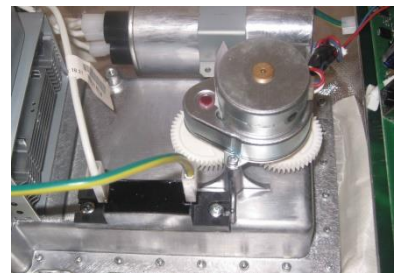

Removing the stirrer motor

1. With the stirrer removed (see above), the stirrer motor on top of the cavity can be dismantled using a pozidriv PZ1 screwdriver.

Note: The threads at the stirrer motor are locked with Loctite.

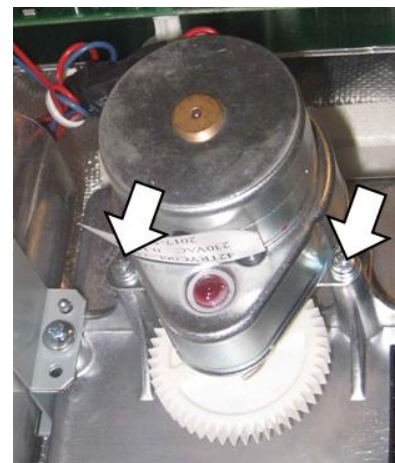

Fitting the stirrer motor

- Follow the steps in the reverse order to fit the stirrer motor.
- The threads at the stirrer motor should be resealed with loctite.

Replacing the convection fan motor and heating element

Requirements and tools

Check that the following requirements have been met:

- The appliance has been disconnected from the power supply and protective measures have been taken to ensure the power cannot be switched on again.
- The appliance is cool.
- The casing of the appliance has been removed.
- The high voltage capacitors are discharged before commencing work.
- Anti-static precautions have been taken.

Tools required:

- M7 hex socket wrench
- Pozidriv PZ1 screwdriver

Component location

The convection motor is positioned on the rear of the cavity.

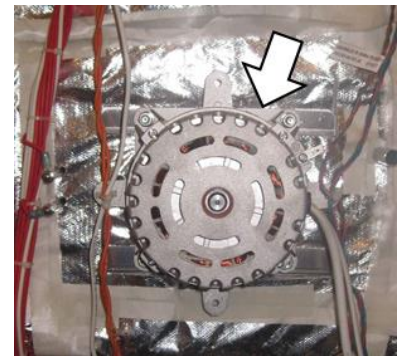

The element connections can be seen to the left of the convection motor.

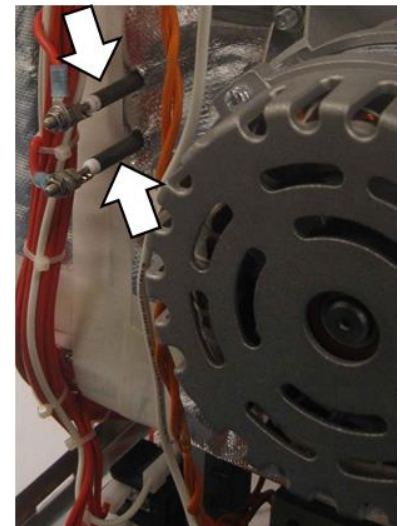

Removing the convection motor and heating element

1. To remove the convection motor assembly, the silver insulation blanket must be peeled back to give access to the 10 x M7 nuts located at the positions indicated in this picture.

Note: Any high-temperature tape compromised when peeling back the insulation will need to be replaced.

The figure below shows the convection fan assembly and element component arrangement.

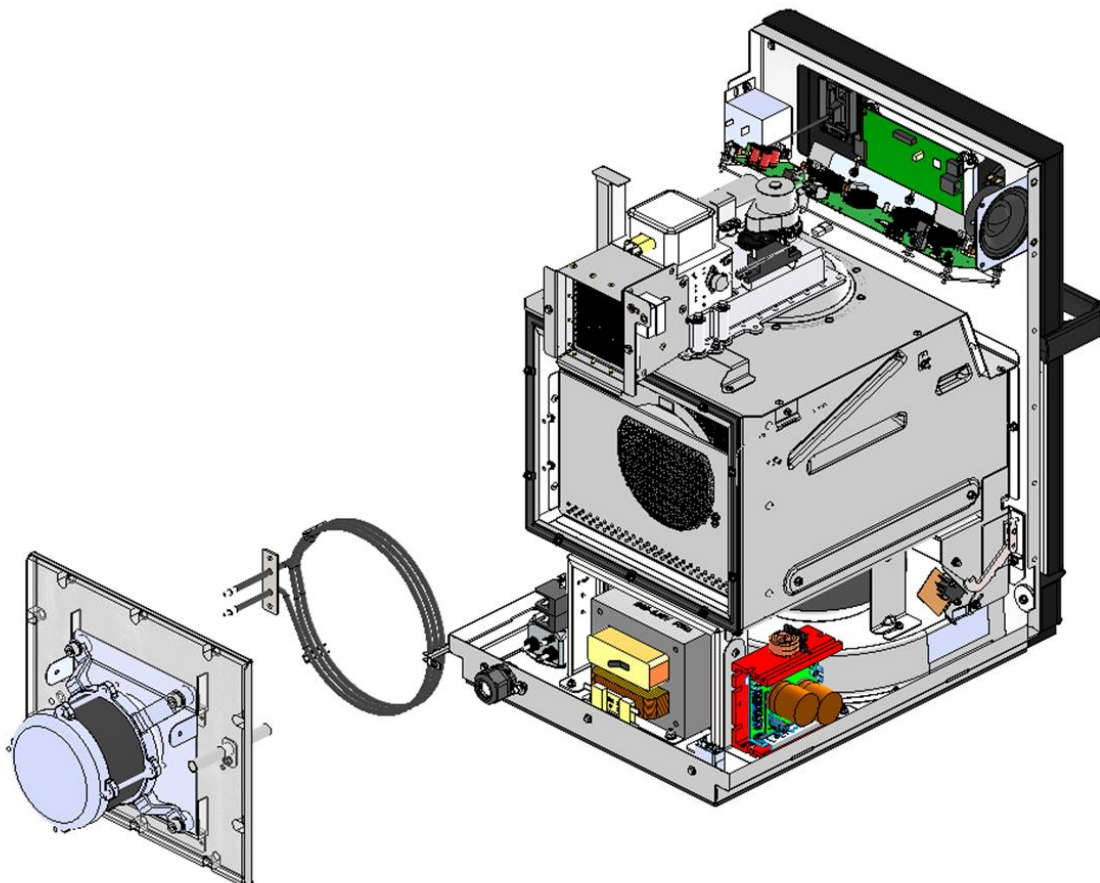

Replacing a transformer (high voltage)

Requirements and tools

Check that the following requirements have been met:

- The appliance has been disconnected from the power supply and protective measures have been taken to ensure the power cannot be switched on again.
- The appliance is cool.
- The casing of the appliance is removed.
- The high voltage capacitors are discharged before commencing work.
- Anti-static precautions have been taken.

Tools required:

- M8 hex socket wrench

Component location

The high voltage transformer is located at the rear of the oven below the cavity.

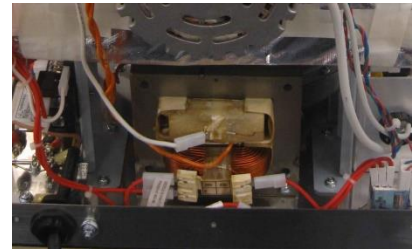

Removing a transformer (high voltage)

1. Unplug all electric connections of the transformer(s).

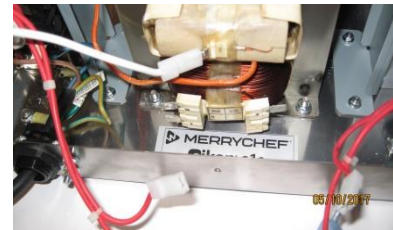

2. Disconnect the transformer(s) from the magnetron(s) by unplugging the orange cables at the magnetron(s).

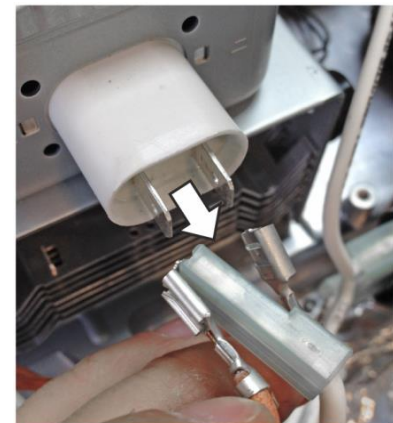

3. Unfasten two M8 nuts and washers to remove the transformer.

CAUTION

The transformer is heavy.

Wear safety shoes to protect your feet from a transformer falling down.

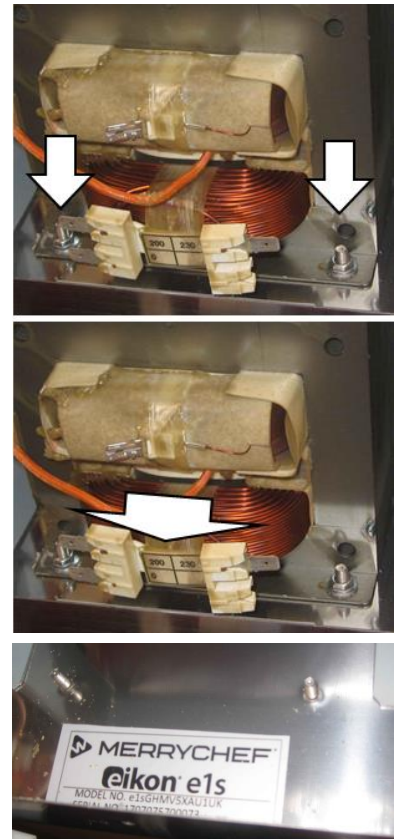

Fitting a transformer (high voltage)

Follow the steps in the reverse order to fit the high voltage transformer(s).

CAUTION

If the electric connections have not been restored properly this may lead to malfunction/damage of the oven.



Replacing the convection fan motor speed controller

Requirements and tools

Check that the following requirements have been met:

- The appliance has been disconnected from the power supply and protective measures have been taken to ensure the power cannot be switched on again.
- The appliance is cool.
- The casing of the appliance is removed.
- The high voltage capacitors are discharged before commencing work.
- Anti-static precautions have been taken.

Tools required:

- M7 hex socket wrench
- Pozidriv PZ2 screwdriver

Component location

The convection fan motor speed controller board is located below the cavity towards the rear of the oven on the left hand side.

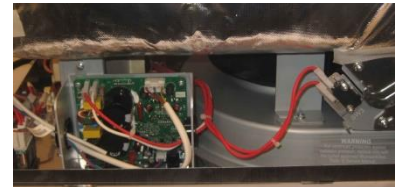

Removing the convection fan motor speed controller

1. After disconnecting the wire connections, unfasten the PZ2 and M7 nut that hold the convection fan motor speed controller board backing plate.

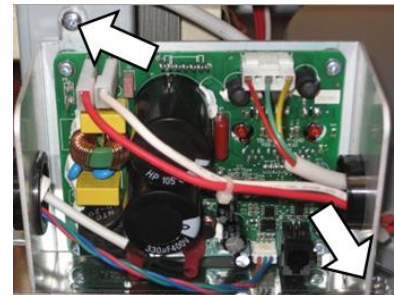

Overview of further components

Before carrying out any procedure on the parts described below, ensure the following requirements have been met:

- The appliance has been disconnected from the power supply and protective measures have been taken to ensure the power cannot be switched on again.
- The appliance is cool.
- The casing of the appliance is removed.
- The high voltage capacitors are discharged before commencing work.
- Anti-static precautions have been taken.

Equipotential bonding connection

The equipotential bonding connection is located at the bottom left corner of the rear panel of the oven next to the mains supply cable.



Electromagnetic Compatibility (EMC) Filter

The EMC filter is located on the base panel at the rear of the appliance on the right hand side.

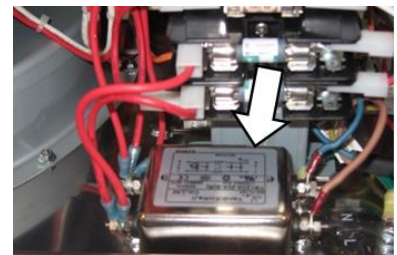

Diode(s) (high voltage)

The high voltage diode is located on top of the cavity behind the magnetron.

Note: When replacing the high voltage diode, ensure it is installed in the correct orientation.

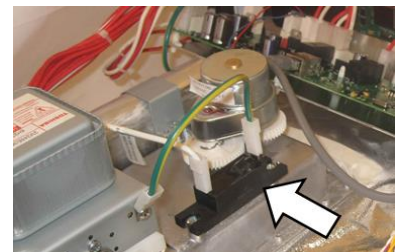

Cavity temperature sensor (thermocouple)

The cavity temperature sensor (thermocouple) provides temperature feedback to the SRB board to control the cavity temperature. The cavity temperature sensor (thermocouple) connects via a black and a red cable to the SRB board and passes in to the front left side of the cavity through a thin tube.

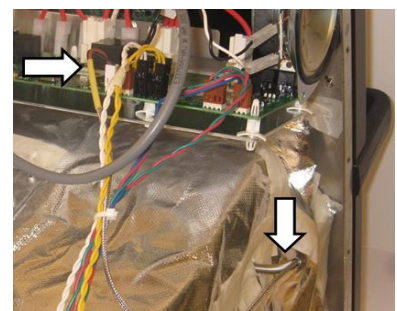

Exhaust pipe

The exhaust pipe leads steam from the cavity to the cooling duct and the rear outlet of the oven. A protective strip prevents touching the outlet when hot.



Cavity high limit

The cavity thermostat is located besides the cooling duct on the left hand side of the oven (when looking at the oven from the rear). It continuously measures the temperature of the cavity and switches the oven off should overheating occur.

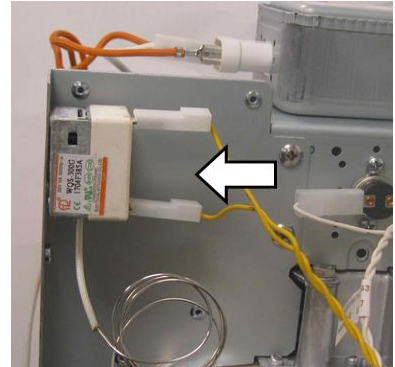

The thermostat uses a temperature sensor which is pinned within a holder located towards the rear of the top left edge of the cavity.

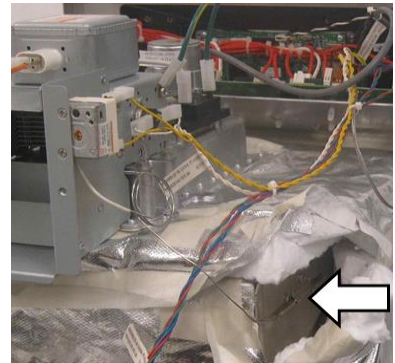

Transformer (low voltage)

The low voltage transformer is located behind the front panel in the top right corner of the appliance.



Capacitor(s) (high voltage)

The high voltage capacitor is located on top of the cavity behind the magnetron and is fixed by a sheet metal bracket.

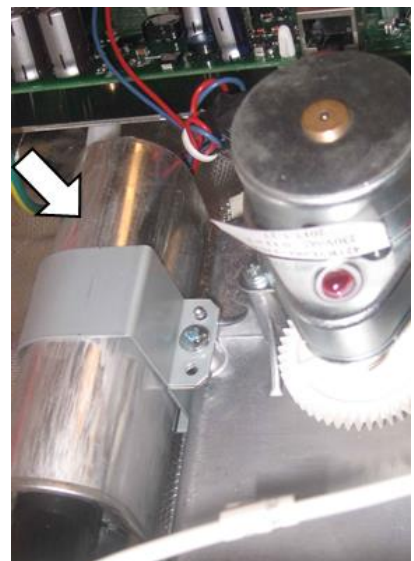

3G. Circuit boards and diagrams

QTS circuit board assembly

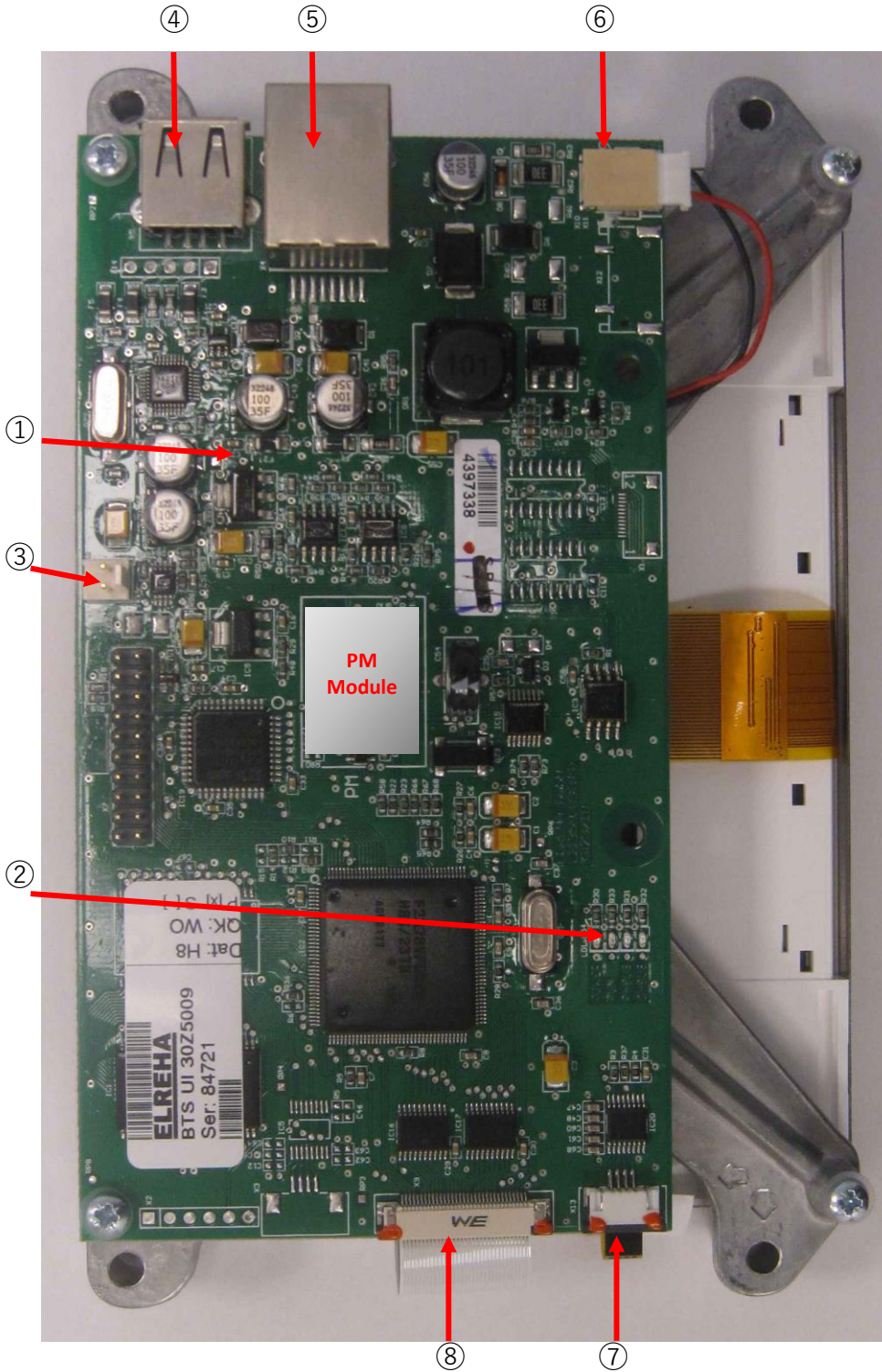

Item	Name
1	LD5
2	Power, Run, P-Bus, C-Bus
3	X6 – speaker
4	X5 – USB socket
5	X4 – Communications to SRB
6	X11 – Screen backlight
7	X13 – Touch pad
8	X9 – Display screen PCB



SRB circuit board

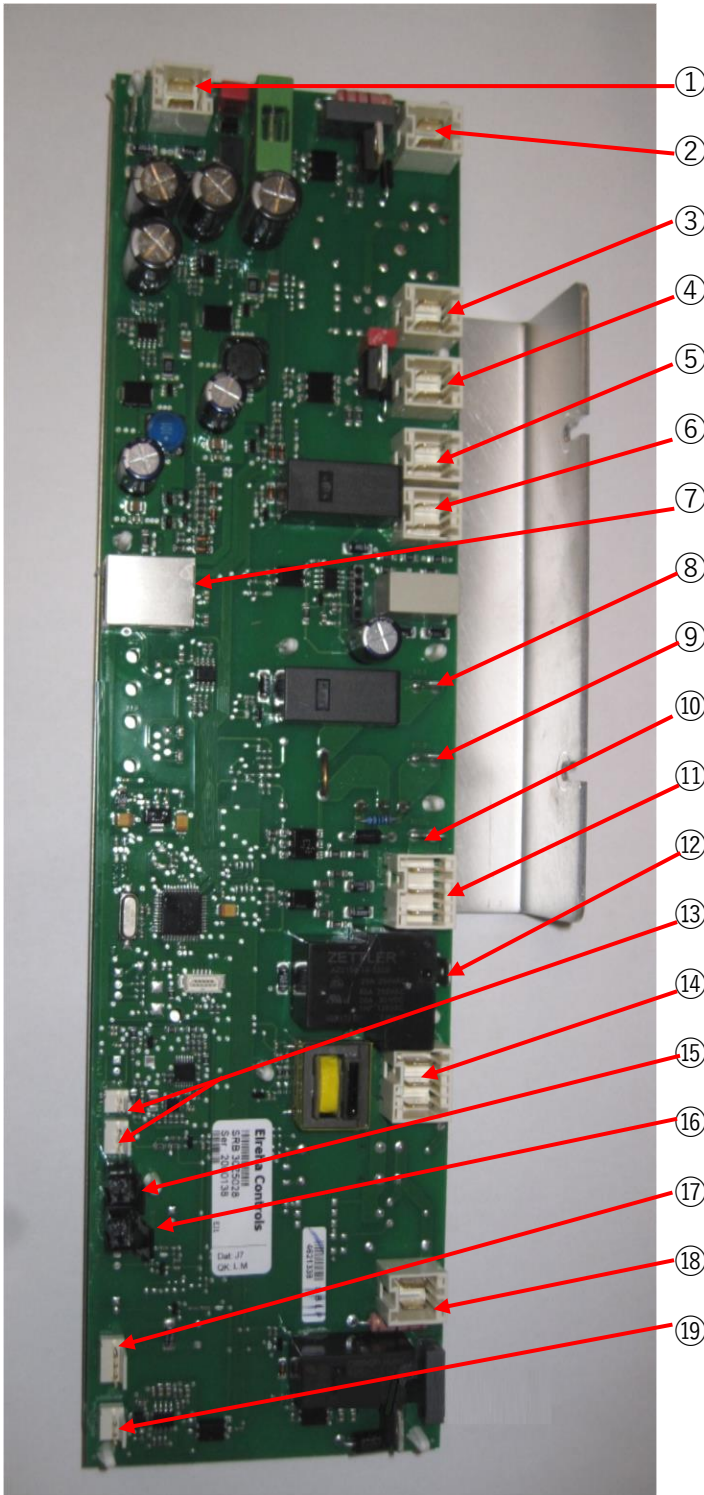

Item	Name
1	X1 – 24V supply from low voltage transformer
2	X8 – Cooling fan
3	X17 – Not used
4	X9 – Mains output, convection fan controller
5	X103.1 – Mains output to low voltage transformer
6	X14 – Cavity temperature sensor (thermocouple)
7	X11 – P/C Bus, BTS cable
8	X2.1 – Mains input, live for heaters
9	X2.2 – Mains output, live to heaters
10	X102a – Mains input, neutral for magnetron transformers and monitor door switch
11	X102b – Mains output, neutral to magnetron transformer and monitor door switch.
12	X4a – Door switch signal from secondary door switch (live for magnetron transformer)
13	X14 – Cavity temperature sensor (thermocouple)
14	X10 – Connector block for door switches
15	X18c – Cavity overheat thermostat
16	X18d – Magnetron overheat thermostat
17	X101 – Voltage selection relay coil feeds. (US version only)
18	X4b – Live for magnetron transformer
19	X3 – Output for convection fan motor speed controller



Circuit diagrams

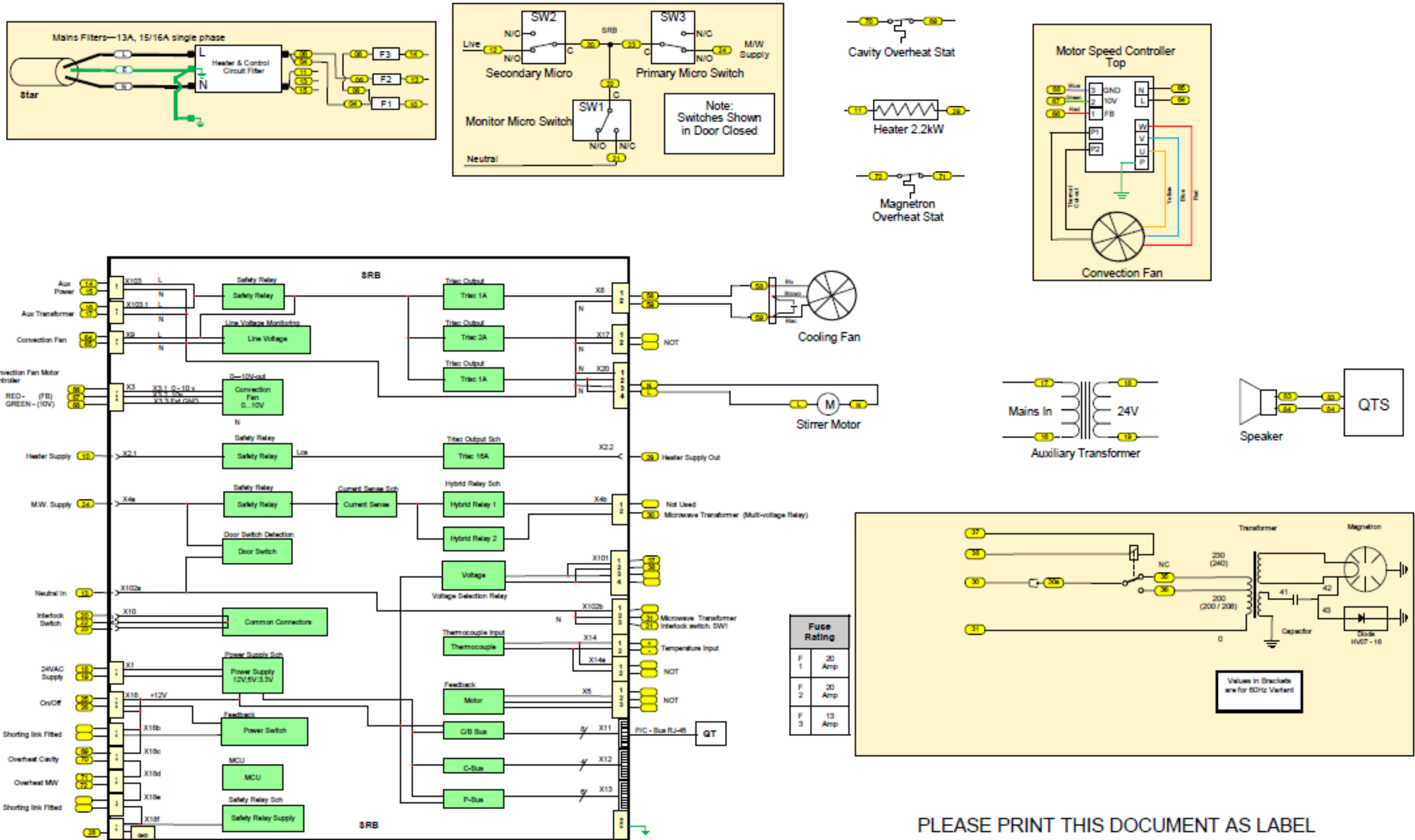

PLEASE PRINT THIS DOCUMENT AS LABEL

eikon[®] e1s

Microwave Combination Oven



Welbilt is one of the world's largest manufacturers and suppliers of professional gastronomic appliances. We supply our customers with energy-saving, reliable and market-leading technologies from a single source. If you want to find out more about Welbilt and its company brands, please visit us at www.welbilt.com