

eikon™ e4s

Installation and Operating Instructions



IMPORTANT INFORMATION READ BEFORE USE







Users are cautioned that maintenance and repairs should be performed by a Merrychef authorized service agent using genuine Merrychef replacement parts. Merrychef will have no obligation with respect to any product that has been improperly installed, adjusted, operated or not maintained in accordance with national and local codes or installation instructions provided with the product, or any product that has its serial number defaced, obliterated or removed, or which has been modified or repaired using unauthorized parts or by unauthorized service agents. For a list of authorized service agents, please refer to the back page of this booklet. The information contained herein (including design and parts specifications) may be superseded and is subject to change without notice.

RENSEIGNEMENTS IMPORTANTS À LIRE AVANT L'UTILISATION

Les utilisateurs sont avisés que l'entretien et les réparations devraient être effectués par un agent de service autorisé de Merrychef utilisant des pièces de rechange d'origine Merrychef. Merrychef rejette toute responsabilité relativement à tout produit qui a été installé, ajusté, utilisé incorrectement ou qui n'est pas entretenu conformément aux codes fédéraux, provinciaux et locaux ou aux instructions d'installation fournies avec l'appareil, ou à tout produit dont le numéro de série a été abîmé, effacé ou enlevé, ou qui a été modifié ou réparé en utilisant des pièces non-autorisées ou par des agents de service non-autorisés. Pour la liste des agents de service autorisés, se référer à la dernière page de ce manuel. Les renseignements contenus dans ce manuel (incluant les spécifications de la conception et des pièces) peuvent être remplacés et sont sous réserve de changements sans préavis.

SAFETY SYMBOLS USED IN THIS DOCUMENT OR ON APPLIANCE

SYMBOLES DE SÉCURITÉ UTILISÉS DANS LE PRÉSENT DOCUMENT OU SUR APPLIANCE

English	Symbol	French
Protective Earth (Ground)		Terre de protection
Dangerous Voltage		Tension dangereuse
Caution, Hot Surface		Attention, surface très chaude
Warning		Avertissement
Caution		Attention
Caution - Microwaves		Attention – Micro-ondes

INTRODUCTION

These ovens offer operators the flexibility of combination cooking with additional control over fan speed and microwave power.

Combination cooking enables high quality results to be achieved in a fraction of the time taken by conventional cooking, particularly when baking, browning, roasting and grilling dishes.

Once established, precise instructions for combination or convection cooking of selected items may be programmed into the oven's memory so that they can be repeated easily and accurately. Up to 1024 programs can be stored and simply recalled.

Multistage Programming

The oven controls offer even greater flexibility by allowing multistage programming. This enables the exact conditions required for quality results to be set according to the food type.

A single cooking program can have up to 6 stages, each stage controlled with its own time, fan speed and microwave power settings (model dependent).

e4s



PRECAUTIONS TO AVOID POSSIBLE EXPOSURE TO EXCESSIVE

MICROWAVE ENERGY

- Do not attempt to operate this oven with the door open since open-door operation can result in harmful exposure to microwave energy. It is important not to defeat or tamper with the safety interlocks.
- Do not place any object between the oven front face and the door or allow soil or cleaner residue to accumulate on sealing surfaces.
- Do not operate the oven if it is damaged. It is particularly important that the oven door closes properly and that there is no damage to the (1) door (bent) (2) hinges and latches (broken or loosened) (3) door seals and sealing surfaces.
- The oven should not be adjusted or repaired by anyone except properly qualified service personnel.



PRÉCAUTIONS POUR ÉVITER L'EXPOSITION EXCESSIVE POSSIBLE À L'ÉNERGIE HF

- Ne pas tenter d'opérer ce four lorsque la porte est ouverte puisque le fonctionnement avec la porte ouverte peut résulter en une exposition dangereuse à l'énergie HF. Il est important de ne pas trafiquer les dispositifs du verrouillage sécuritaire.
- Ne jamais placer d'objet entre l'avant du four et la porte ou permettre aux saletés ou aux résidus du nettoyeur de s'accumuler sur les surfaces d'étanchéité.
- Ne pas utiliser le four si celui-ci est endommagé. Il est particulièrement important que la porte se ferme correctement et qu'il n'existe aucun signe de dommage sur (1) la porte (pliée), (2) les charnières et les verrous (cassés ou desserrés), (3) les joints de la portes et les surfaces d'étanchéité.
- Le four ne devrait pas être ajusté ou réparé par personne d'autre que le personnel de service qualifié.

The instructions outlined in this guide are intended to ensure the safety and long life of your Merrychef oven.

PLEASE READ THE FOLLOWING SAFETY INSTRUCTIONS CAREFULLY

CONTENTS

INTRODUCTION	2
SAFETY & REGULATIONS	
IMPORTANT SAFETY INSTRUCTIONS	5
PRECAUTIONS TO BE OBSERVED	6
SUITABLE COOKING UTENSILS	5
PRODUCT DETAILS	
MAIN FEATURES	9
TECHNICAL SPECIFICATIONS	10
Specifications	10
Serial Number (Rating Plate)	10
INSTALLATION	11
OVEN LOCATION AND POSITIONING	11
ELECTRICAL INSTALLATION	12-13
OPERATION & CONTROLS	
QUICK START GUIDE: QUICK SERVICE OVEN	14
START UP	14
USING A COOKING PROGRAM	15
SCREEN SAVER	15
OPERATING GUIDE: FULL SERVICE OVEN	16
easyToUCH MAIN MENU & KEYBOARD SCREEN	16
DEVELOPMENT MODE: CREATING A COOK PROGRAM	17
PRESS & GO	18
USING A COOKBOOK PROGRAM	18
CHANGING THE OVEN TEMPERATURE	19
VIEWING & EDITING PROGRAMS	19
ADDING A NEW PROGRAM GROUP	20
MOVE A PROGRAM WITHIN A PROGRAM GROUP	20
ADDING A PROGRAM TO A GROUP	21
MANAGING PROGRAM GROUPS	21
OVEN CONTROL SETTINGS	22
Oven mode/navigation settings (A)	22
Language options (B)	22
Oven temperature settings and labels (C)	22
Recipe counters (E)	23
Date and Time settings (F)	23
Sound levels (G)	23
Oven Timer (H)	23
USB oven programs (J)	24
Temperature Band (K)	24
Change Password (L)	24
Screen saver (M)	24
CLEANING & MAINTENANCE	
COOLING THE OVEN DOWN BEFORE CLEANING	25
Oven cool down	25
Preparing to clean the oven	25
Cold oven CLEANING INSTRUCTIONS e4s	26
FAULT FINDING	
FAULT FINDING CHART	27
SERVICING	28

IMPORTANT SAFETY INSTRUCTIONS

When using electrical appliances basic safety precautions should be followed, including the following:

WARNING: To reduce the risk of burns, electric shock, fire, injury to persons, or exposure to excessive microwave energy:

1. Read all instructions before using the appliance.
2. Read and follow the specific "PRECAUTIONS TO AVOID POSSIBLE EXPOSURE TO EXCESSIVE MICROWAVE ENERGY" found on the Introduction page.
3. This appliance must be grounded. Connect only to a properly grounded outlet. See "ELECTRICAL INSTALLATION".
4. Install or locate this appliance only in accordance with the provided installation instructions.
5. **WARNING:** Liquids or other foods must not be heated in sealed containers since they are liable to explode.
6. Use this appliance only for its intended use as described in the manual. Do not use corrosive chemicals or vapours in this appliance. This type of oven is specifically designed to heat, cook or dry food. It is not designed for industrial or laboratory use.
7. This appliance should not be used by children.
8. If the supply cord is damaged, it must be replaced by the manufacturer, its service agent or similarly qualified persons in order to avoid a hazard.
9. **WARNING:** it is hazardous for anyone other than a competent person to carry out any service or repair operation that involves the removal of any cover which gives protection against exposure to microwave energy.
10. Do not cover or block any openings on the appliance including air vents/filters and steam outlet.
11. Do not store this appliance outdoors. Do not use this product near water — for example, near a kitchen sink, in a wet basement, or near a swimming pool, and the like.
12. Do not immerse the power cord or plug in water.
13. Keep the cord away from heated surfaces.
14. Do not let the cord hang over an edge of a table or counter.
15. Either:
 - i) When cleaning surfaces of door and oven that come together on closing the door, use only mild non-abrasive soaps, or detergents applied with a sponge or soft cloth.
 - ii) When separate cleaning instructions are provided, see door surface cleaning instructions.
16. To reduce risk of fire in the cavity:
 - i) When heating food in plastic or paper containers, keep an eye on the oven due to the possibility of ignition.
 - ii) Remove wire twist-ties from paper or plastic bags before placing bag in oven.
 - iii) If materials inside the oven should ignite, keep oven door closed, turn oven off, and disconnect the power cord, or shut off power at the fuse or circuit breaker panel.
- iv) Do not use the cavity for storage purposes. Do not leave paper products, cooking utensils or food in the cavity when not in use.
17. **WARNING:** Microwave heating of beverages can result in delayed eruptive boiling therefore care must be taken when handling the container.
18. **DO NOT** operate using microwave only or combination function without food or liquid inside the oven as this may result in overheating and may cause damage.
19. **NEVER** remove the exterior of the oven.
20. **NEVER** remove any fixed internal parts of the oven.
21. **NEVER** tamper with the control panel, door, seals, or any other oven part.
22. **DO NOT** obstruct air vents/filters or steam outlet.
23. **NEVER** hang dish towels or cloths on any part of the oven.
24. **WARNING:** If the door or door seals are damaged, the oven must not be operated until it has been repaired by a competent person.
25. If the power cable is damaged in any way it **MUST** be replaced by an approved Service Agent.
26. When handling hot liquids, foods, and containers, care should be taken to avoid scalds and burns.
27. When heating liquids using microwave only or combination function, the contents should be stirred prior to heating to avoid eruptive boiling.
28. **WARNING:** The contents of feeding bottles and baby food jars must be stirred or shaken and the temperature checked before consumption in order to avoid burns.
29. Never use the oven to heat alcohol, e.g. brandy, rum, etc. Food containing alcohol can more easily catch fire if overheated, observe caution and do not leave the oven unattended.
30. Never attempt to deep fry in the oven.
31. This appliance is not intended for use by persons (including children) with reduced physical sensory or mental capabilities, or lack of experience and knowledge, unless they have been given supervision or instruction concerning use of the appliance by a person responsible for their safety.
32. Children should be supervised to ensure that they do not play with the appliance.

SAVE THESE INSTRUCTIONS

PRECAUTIONS TO BE OBSERVED

1. Read this manual before using your oven.
2. As with all electrical appliances, it is wise to have the electrical connections inspected at least once a year.
3. The oven interior, door seals should be cleaned frequently, following the instructions described in the cleaning section, failure to do so could possibly result in a hazardous situation.
4. Switch off the oven at the end of all the cooking sessions for that day.
5. The oven should not be used to dry linen.
6. As with any cooking appliance, care should be taken to avoid combustion of the items within the oven.
7. Food in combustible plastic or paper containers should be transferred to a microwave/oven proof containers to avoid the possibility of ignition.
8. Items should be unwrapped when using convection and combination functions.
9. Eggs in their shells and hard boiled eggs should not be heated in microwave ovens since they may explode even after microwave heating has ended.
10. Food with a skin, e.g. Potatoes, apples, sausages etc. should be pierced before heating.
11. Food should not be heated in a completely sealed container as the build-up of steam may cause it to explode.
12. Excess fat should be removed during 'roasting' and before lifting heavy containers from the oven.
13. In the event of glass breaking or shattering within the oven, ensure that food is totally free of glass particles. If in doubt, dispose of any food that was in the oven at the time of the breakage.
14. DO NOT attempt to operate the oven with: object caught in door, that does not close properly or damaged door, hinge, latch, sealing surface or without food in the oven.

If smoke is observed:

- Switch off
- Isolate from the electrical supply
- Keep the door closed to stifle any flames

SUITABLE COOKING UTENSILS

Manufacturer's instructions should be checked to determine the suitability of individual containers or utensils using each of the cooking functions. The following chart provides general guidelines:

Heat resistant containers		
Toughened glass Vitreous ceramics Earthenware (porcelain/crockery/china etc.)	✓ ✓ ✓	Do not use items with metallic decoration.
Metallic & Foil Trays		
Metallic trays DO NOT USE ANY OTHER METAL OR FOIL CONTAINERS	✓	Metallic trays may only be used when placed on the VITREOUS RACK in the oven cavity. Note: Do not cook food directly on the vitreous enamel rack.
Plastic containers		
Dual-ovenable plastic containers	✓	(up to certain temperatures) are now available. Check manufacturer's instructions before use.
Disposables		
DO NOT USE Combustibles (paper/card etc.)	✗	
Other utensils		
Tie tags Cutlery Temperature probes	✗ ✗ ✗	No kitchen utensil should be left in food while it is cooking in the oven.

DIRECTIVES IMPORTANTES PORTANT SUR LA SÉCURITÉ

Lors de l'utilisation d'appareils électriques, des précautions sécuritaires fondamentales doivent être prises incluant ce qui suit:

AVERTISSEMENT: Pour réduire les risques de brûlures, de chocs électriques, d'incendie, de blessures corporelles ou d'exposition excessive à l'énergie HF:

1. Lire toutes les directives avant d'utiliser l'appareil.
2. Lire et observer spécifiquement les « PRÉCAUTIONS POUR ÉVITER UNE EXPOSITION EXCESSIVE À L'ÉNERGIE HF » indiquées à la page d'introduction.
3. Cet appareil doit être mis à la terre. Ne le brancher qu'à une prise de courant correctement mise à la terre. Voir « INSTALLATION ÉLECTRIQUE ».
4. Installer ou localiser cet appareil conformément aux instructions d'installation fournies.
5. Certains produits comme des oeufs entiers et des contenants scellés (pots fermés par exemple) peuvent exploser et ne devraient pas être chauffés dans ce four.
6. Utiliser cet appareil uniquement aux fins prévues décrites dans le manuel. Ne pas utiliser de produits chimiques ou des vapeurs corrosifs dans cet appareil. Ce type de four est conçu spécialement pour chauffer, cuire ou sécher des aliments. Il n'est pas conçu pour un usage commercial ou en laboratoire.
7. Cet appareil ne devrait pas être utilisé par les enfants.
8. Ne pas utiliser cet appareil si le cordon électrique ou la prise sont endommagés, s'il ne fonctionne pas correctement ou s'il a été endommagé ou échappé.
9. Cet appareil doit être entretenu uniquement par un personnel de service qualifié. Contacter le centre de service autorisé le plus près pour l'inspection, la réparation ou les ajustements.
10. Ne pas couvrir ou bloquer les ouvertures de l'appareil incluant les événements et les filtres à air et les orifices de sortie de la vapeur.
11. Ne pas entreposer cet appareil à l'extérieur. Ne pas utiliser cet appareil près de l'eau (près d'un évier de cuisine, dans une cave humide, près d'une piscine, par exemple).
12. Ne pas immerger le cordon électrique ou la prise dans l'eau.
13. Maintenir le cordon électrique éloigné des surfaces chaudes.
14. Ne pas laisser le cordon électrique pendre sur le bord de la table ou du comptoir.
15. L'un ou l'autre de ce qui suit:
 - i) Lors du nettoyage des surfaces de la porte et des surfaces du four faisant contact à la fermeture de la porte, utiliser uniquement des savons doux ou des détergents non-abrasifs appliqués avec une éponge ou un linge doux.
 - ii) Lorsque d'autres instructions de nettoyage sont fournies, voir les instructions de nettoyage des surfaces de la porte.
16. Pour réduire les risques d'incendie dans la cavité:
 - i) Ne pas faire trop cuire les aliments. Surveiller l'appareil avec soin si des matériaux de papier, de plastique ou autres matériaux combustibles sont placés dans le four pour faciliter la cuisson.

- ii) Enlever les ligatures métalliques des sacs de papier ou de plastique avant de les placer dans le four.
 - iii) Si les matériaux dans le four s'enflamment, maintenir la porte du four fermée, commuter le four hors circuit, débrancher le cordon électrique et couper l'alimentation électrique au panneau des fusibles ou des disjoncteurs.
 - iv) Ne pas utiliser la cavité du four à des fins d'entreposage. Ne pas laisser de produits de papier, d'ustensiles de cuisson ou des aliments dans la cavité lorsque le four n'est pas utilisé.
17. Des liquides comme l'eau, le café ou le thé peuvent être surchauffés au-delà du point d'ébullition sans qu'il y ait des signes d'ébullition. Des signes visibles de bouillonnement ou d'ébullition ne sont pas toujours présents lorsque le contenant est retiré du four micro-ondes. **CECI POURRAIT RÉSULTER EN UNE ÉBULLITION SOUDAINE LORSQUE LE CONTENANT EST DÉPLACÉ OU LORSQU'UN USTENSILE EST INTRODUIT DANS LE LIQUIDE.**
18. **NE PAS UTILISER** la fonction micro-ondes seulement ou la fonction combinée s'il n'y a pas d'aliment ou de liquide dans le four puisque ceci pourrait causer une surchauffe et des dommages.
19. **NE JAMAIS RETIRER** le boîtier extérieur du four.
20. **NE JAMAIS RETIRER** les parties internes fixes du four.
21. **NE JAMAIS TRAFIQUER** le tableau de commande, la porte, les joints ou toute autre pièce du four.
22. **NE JAMAIS OBSTRUER** les événements et les filtres à air ou l'orifice de sortie de la vapeur.
23. **NE JAMAIS SUSPENDRE** de torchons ou de linges à vaisselle sur une partie du four.
24. Si les joints de la porte sont endommagés, le four doit être réparé par un agent de service agréé.
25. Si le cordon électrique est endommagé de quelque façon, il **DOIT** être réparé par un agent de service agréé.
26. Lors de la manipulation de liquides, aliments et contenants chauds, prendre des précautions pour éviter les brûlures.
27. Lors du chauffage de liquides utilisant la fonction micro-ondes seulement ou la fonction combinée, le contenu devrait être brassé avant le chauffage pour éviter l'ébullition éruptive.
28. Les biberons et les jarres d'aliment pour bébé ne devraient pas être chauffés dans cet appareil.
29. Ne jamais utiliser le four pour chauffer de l'alcool, c.-à-d., brandy, rhum, etc. Les aliments contenant de l'alcool peuvent facilement prendre feu s'ils sont surchauffés. Être prudent et ne jamais laisser le four sans surveillance.
30. Ne jamais tenter de friture dans le four.
31. L'appareil n'est pas conçu pour être utilisé par les enfants ou les personnes infirmes sans supervision.
32. Les enfants devraient être surveillés pour s'assurer qu'ils ne jouent pas avec l'appareil.

CONSERVER CES INSTRUCTIONS

PRÉCAUTIONS À PRENDRE

1. Lire ce manuel au complet avant d'utiliser votre four.
2. Comme pour tous les appareils électriques, il est sage de faire inspecter les connexions électriques au moins une fois par année.
3. L'intérieur du four, les joints de la porte devraient être nettoyés fréquemment, conformément aux directives présentées à la section portant sur le nettoyage. Le manquement à ces directives peut créer des situations dangereuses.
4. Commuter le four hors circuit à la fin de toutes les sessions de cuisson pour la journée.
5. Le four ne doit pas être utilisé pour faire sécher des linges.
6. Comme pour tout autre appareil de cuisson, prendre soin d'éviter toute combustion d'articles dans le fourneau.
7. Les aliments dans des contenants combustibles de plastique ou de papier devraient être transférés dans des contenants pouvant être utilisés dans un four à micro-ondes/ordinaires pour prévenir les risques d'ignition.

Si on observe de la fumée:

- Commuter le four hors circuit
- Fermer le disjoncteur/commutateur de l'alimentation électrique
- Garder la porte fermée pour étouffer les flammes

8. Les articles devraient être déballés lorsque les fonctions de cuisson par convection ou combinée sont utilisées.
9. Les oeufs en coquille et les oeufs durs complets ne doivent pas être chauffés dans le four puisqu'ils peuvent exploser.
10. Les aliments avec pelure, c.-à-d., pommes de terre, pommes, saucisse, etc. devraient être percés avant d'être chauffés.
11. Les aliments ne doivent pas être chauffés dans un contenant complètement scellé puisque la montée de vapeur peut causer une explosion.
12. L'excès de gras devrait être enlevé durant le rôtiage et avant de retirer des contenants lourds du four.
13. Dans le cas où du verre casse ou se brise dans le four, s'assurer que les aliments sont complètement libres de toutes particules de verre. En cas de doute, jeter tous les aliments qui se trouvaient dans le four au moment du bris.
14. NE JAMAIS TENTER d'utiliser le four lorsqu'un objet bloque la porte qui ne se ferme pas correctement ainsi que lorsque la porte, le verrouillage, les surfaces d'étanchéité sont endommagées ou lorsqu'il n'y a pas d'aliments dans le four.

USTENSILES DE CUISSON APPROPRIÉS

Les directives du fabricant devraient être consultées pour déterminer l'adéquation de chaque contenant et ustensile individuel pour chacune des fonctions de la cuisson. Le tableau suivant présente les directives générales:

Contenants résistant à la chaleur		
Verre trempé Céramique vitreuse Grès, faïence (porcelaine/poterie/etc.)	✓ ✓ ✓	Ne pas utiliser d'articles portant des décorations métalliques.
Plateaux métalliques et de feuilles métalliques		
Plateaux métalliques NE PAS UTILISER D'AUTRES CONTENANTS MÉTALLIQUES OU DE FEUILLES MÉTALLIQUES	✓	Les plateaux métalliques ne peuvent être utilisés que lorsqu'ils sont placés sur la GRILLE VITREUSE dans la cavité du four. Ne pas cuire les aliments directement sur la grille en émail vitrifié.
Contenants de plastique		
Contenants de plastique utilisables dans les deux types de fours	✓	(jusqu'à certaines températures) sont maintenant disponibles. Vérifier les directives du fabricant avant d'utiliser.
Contenants jetables		
NE PAS UTILISER Combustibles (papier/carton/etc.)	✗	
Autres ustensiles		
Attaches-étiquettes Coutellerie Capteurs thermiques	✗ ✗ ✗	Aucun ustensile de cuisine ne doit être laissé dans les aliments pendant qu'ils cuisent dans le four.

MAIN FEATURES

1 ON/OFF SWITCH

When switched ON the easyToUCH screen illuminates the oven controls. Note; turning this switch OFF does not isolate the oven from the electricity supply.

2 easyToUCH SCREEN CONTROL PANEL

See 'OPERATION & CONTROLS' for details.

3 RATING PLATE

Located on the rear panel of the oven states the serial number, model type & electrical specifications.

4 USB port/Merrychef badge

A USB socket located under the Merrychef logo allows changes to programs stored on the oven (See USB MenuConnect™ User Manual, and Operation & Controls section of this manual, for details of updating oven programs).

5 AIR OUTLETS

Air used to cool internal components and steam from the cavity escape through the air outlet vents located on the rear of the oven. The air outlets must be kept free from obstruction and they will not allow microwave energy to escape into the environment.

6 AIR INLET FILTER

The air filter situated at the lower front of the oven is part of the ventilation system and must be kept free of obstruction and cleaned daily as described under 'Cleaning & Maintenance'. Note, the oven will not operate without the air filter fitted.

7 DOOR HANDLE

This is a rigid bar which is pulled downwards and away from the oven to open.

8 OVEN DOOR

This is a precision-made energy barrier with three microwave safety interlocks. The door must be kept clean (see 'CLEANING') and should NOT be used to support heavy objects.

9 DOOR SEALS

These ensure a tight seal around the door. They should be kept clean and checked regularly for signs of damage. At the first sign of wear they should be replaced by a Merrychef approved Service Agent.

10 CONVECTION FAN, AIR DIFFUSER & CATALYTIC CONVERTOR

The convection fan must be kept clean and free of debris. Great care should be taken when cleaning this area of the oven noting the different oven requirements shown under 'Cleaning & Maintenance' in this manual.

11 OVEN CAVITY

The oven cavity is constructed from stainless steel and must be kept clean by following the cleaning instructions in the 'Cleaning & Maintenance' section of this manual.

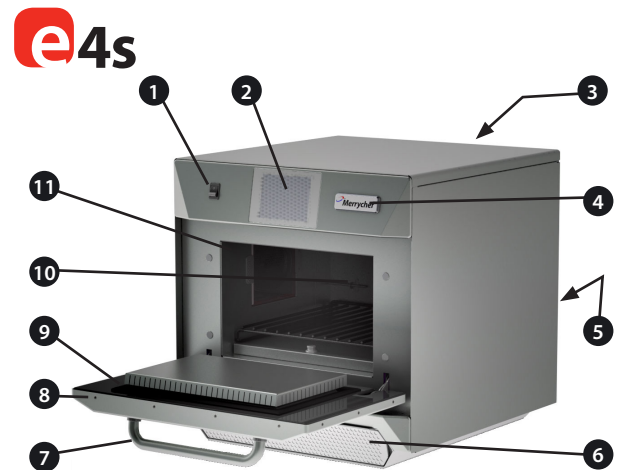

TECHNICAL SPECIFICATIONS

Specifications

Description	unit	e4s
Touch screen controls	programs	1024
Ambient operating temperature	°C/°F	<40/104
External HxWxD	mm	591x584x750
External HxWxD	inches	23.3x23.0x29.5
Internal HxWxD	mm	218x375x361
Internal HxWxD	inches	8.6x14.8x14.2
Cooking chamber	Ltr (cu.ins)	29.5 (1800)
Power output microwave	Watts	1800
Power output convection	kW	3.2
Power supply	Hz	50 or 60
Power supply	V	230 (50Hz), 208/240 or 220 (60Hz)
Power supply	kW	6.2
Unpackaged oven weight nett	Kg (lbs)	86.3 (190)
Sound pressure level	dB(A)	<60

PRODUCT DETAILS

e4s

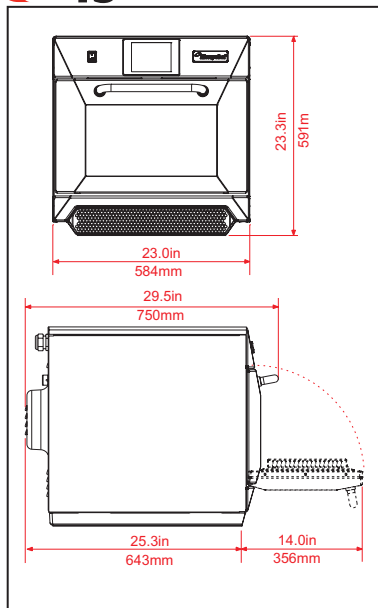

Power Supply Configuration

(Refer to Rating Plate)

Power Supply Configuration (Refer to Rating Plate)		
Model	e4SSTMV6*****	2P & G 208V / 240V ac 60Hz 30Amp
Plug	Nema 6-30P	

Suitably rated Branch Circuit Protection must be provided in accordance with applicable Local Electrical Code – see 'ELECTRICAL INSTALLATION'

Un protecteur de circuit approuvé, de marque reconnue, doit être utilisé selon les normes locales d'installation électrique – voir 'INSTALLATION ELECTRIQUE'

Serial Number (Rating Plate):

Serial number: YY MM SITE SERIAL i.e. 10 06 2130 12345 (1006213012345)

Oven manufactured 2010 in June at Sheffield (UK), production number 12345.

Model Number: MODEL CONVECTION MICROWAVE VOLTAGE HERTZ LEAD PLUG

COMMUNICATION VERSION CUSTOMER/ACCESSORY COUNTRY i.e. e4s S T MV 6 D F U 1 GM US (e4SSTMV6DFU1GMUS)

model e4s, 3200W, 1800W, 208V or 240V, 60Hz, 2P+GND (30A), moulded NEMA 6-30P plug, USB, 1, General Market, USA.

INSTALLATION

Check for obvious signs of transit damage.

If necessary, inform the freight company IMMEDIATELY.

Remove packing material and protective film from the oven and safely discard.

Included inside your oven:

Model e4s Series:

- Self-supporting Rack
- Vitreous Enamel Tray
- Cool down Rack

OVEN LOCATION AND POSITIONING

Choose a site away from major heat sources.

DO NOT position so that hot air is drawn in from fryers, grills, griddles, etc.

A heat barrier to the height of the oven must be installed if sited next to a burner, stove or range.

Place the oven on a permanent nonslip/nonflammable flat surface that is LEVEL, STABLE and STRONG enough for the oven and contents.

Allow a minimum clearance (A) of 2 inches (50mm) around the oven for hot air to escape.

Allow sufficient clearance (B), in front of the oven for the door to open fully.

Position the oven at least 36 inches (916mm) (C) above the floor.

The air intake is located at the lower front of the oven (1) and it is important that the airflow is as cool as possible and not preheated by other appliances such as burners, stoves, ranges, fryers, grills and griddles as this will deteriorate the life and performance of the oven.

Do not affix labels/stickers to oven other than those applied or approved by the manufacturer.

 The oven will not operate without the AIR FILTER correctly fitted in place.

HANDLING & STORAGE:

When moving an oven always observe and follow national and local requirements for lifting and moving heavy objects. Do not use the oven door handle to lift oven.

When not in use, electrically disconnect the oven and store safely in a dry cool place, do not stack ovens.

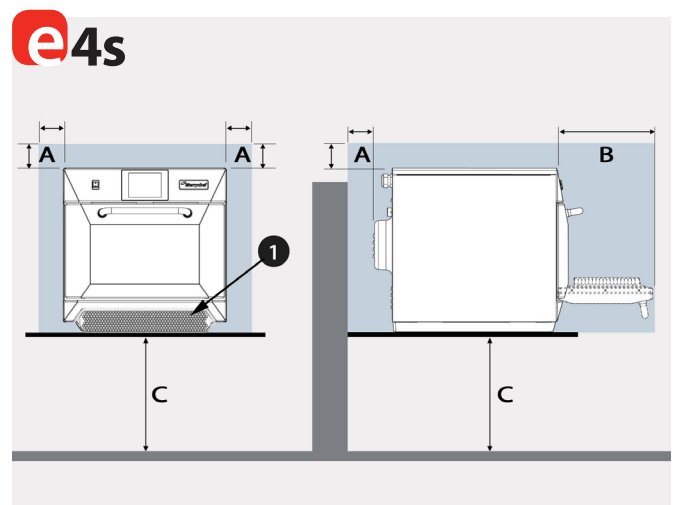

ELECTRICAL INSTALLATION



DANGER!

THIS APPLIANCE MUST BE EARTHED. FAILURE TO DO SO MAY RESULT IN ELECTRIC SHOCK AND DEATH.



DANGER!

CET APPAREIL DOIT ÊTRE MIS À LA TERRE. LE MANQUEMENT À CETTE RÈGLE PEUT RÉSULTER EN DES CHOCS ÉLECTRIQUES POUVANT CAUSER LA MORT.

For all cord connected appliances:

GROUNDING INSTRUCTIONS

This appliance must be grounded. In the event of an electrical short circuit, grounding reduces the risk of electric shock by providing an escape wire for the electric current. This appliance is equipped with a cord having a grounding wire with a grounding plug. The plug must be plugged into an outlet that is properly installed and grounded.

WARNING - Improper use of the grounding can result in the risk of electric shock.

Consult a qualified electrician or Serviceman if the grounding instructions are not completely understood or if doubt exists as to whether the appliance is properly grounded.

Do not use an extension cord. If the power supply cord is too short, have a qualified electrician or serviceman install an outlet near the appliance.

For a permanently connected appliance:

GROUNDING INSTRUCTIONS

This appliance must be connected to a grounded, metallic, permanent wiring system, or an equipment grounding conductor should be run with the circuit conductors and connected to the equipment grounding terminal or lead on the appliance.

ELECTRICAL CODE REFERENCE

IN USA

When installed, this appliance must be electrically grounded and its installation must comply with the National Electrical Code, ANSI-NFPA 70, latest edition, the Manufacturer's Installation Instruction, and applicable municipal building codes.

IN CANADA

All electrical connections are made in accordance with CSA C22.1 - Canadian Electrical Code Part 1 and/or local codes.

IN CASE OF RADIO OR TELEVISION INTERFERENCE

This equipment generates and uses radio frequency energy and if not installed and operated correctly, in strict accordance with the manufacturer's instructions, may cause harmful interference to authorized radio communication services.

This product complies with the relevant requirements of CFR 47 Ch.1 Part 18, which are designed to provide reasonable protection against such interference. However, there is no guarantee that interference will not occur in a particular installation. If this equipment does cause interference to radio or television reception, which can be determined by turning the equipment off and on, the user is encouraged to try and correct the interference by one or more of the following measures:

- 1) Re-orientate the receiving antenna.
- 2) Relocate the microwave with respect to the receiver.
- 3) Plug the microwave into a different outlet so that the receiver and microwave are on different branch circuits.

If necessary the user should consult the dealer or an experienced radio/television technician for additional suggestions.

Note: Modifications should only be carried out by the manufacturer or authorized representative to ensure continuing conformance.

This device complies with Part 18 of the FCC rules.

INSTALLATION ÉLECTRIQUE



DANGER!

CET APPAREIL DOIT ÊTRE MIS À LA TERRE. LE MANQUEMENT À CETTE RÈGLE PEUT RÉSULTER EN DES CHOCS ÉLECTRIQUES POUVANT CAUSER LA MORT.



DANGER!

THIS APPLIANCE MUST BE EARTHED. FAILURE TO DO SO MAY RESULT IN ELECTRIC SHOCK AND DEATH.

Pour tous les appareils utilisant un cordon d'alimentation :

INSTRUCTIONS POUR LA MISE À LA TERRE

Cet appareil doit être mis à la terre. Si un court-circuit électrique survient, la mise à la terre réduit les risques de chocs électriques en offrant un conducteur de fuite pour le courant électrique. Cet appareil est équipé d'un cordon ayant un conducteur de mise à la terre et d'un connecteur ayant une broche de mise à la terre. Le connecteur doit être branché à une prise de courant installée et mise à la terre correctement.

AVERTISSEMENT - Une méthode inadaptée de mise à la terre peut causer des risques de chocs électriques. Consulter un électricien ou un technicien de service qualifié si les directives portant sur la mise à la terre ne sont pas comprises ou si un doute existe si oui ou non l'appareil est mis à la terre correctement.

Ne pas utiliser de cordon prolongateur. Si le cordon d'alimentation est trop court, demander à un électricien ou un technicien qualifié d'installer une nouvelle prise de courant près de l'appareil.

Pour un appareil branché en permanence :

INSTRUCTIONS POUR LA MISE À LA TERRE

Cet appareil doit être branché à un système de câblage métallique permanent mis à la terre ou un conducteur de mise à la terre pour appareil devrait être acheminé avec les conducteurs des circuits et branché à la borne ou au conducteur de mise à la terre de l'appareil.

Reference du code électrique aux Etats-Unis AU USA

Lors de l'installation, cet appareil doit être mis en terre (grounded), Et doit se conformer au Code électrique National, ANSI-NFPA 70, dernière édition. Suivre les instructions d'installation du fabricant, et les codes de bâtiment municipaux applicables.

AU CANADA

Toutes les connexions électriques sont conformément faites à CSA C22.1 Le code d'électricité canadien, partie 1 et/ou les codes locaux.

EN CAS D'INTERFÉRENCES DANS LES SIGNAUX DE RADIO/ TÉLÉVISION

Cet équipement génère et utilise de l'énergie FR et s'il n'est pas installé et utilisé correctement, en stricte conformité avec les directives du fabricant, il peut générer de l'interférence nuisible aux services de communication radio autorisés. Ce produit est conforme aux exigences applicables de la Clause 18, du Chapitre 1 du CFR 47, qui sont conçus pour assurer une protection raisonnable contre de telles interférences. Cependant, il n'existe aucune garantie que des interférences ne surviendront pas dans une installation donnée. Si cet équipement cause de l'interférence à la réception des signaux radio/télévision, ce qui peut être facilement déterminé en commutant l'équipement en/hors circuit, nous recommandons à l'utilisateur de tenter d'éliminer l'interférence en utilisant une ou plusieurs des méthodes suivantes :

- 1) Réorienter l'antenne de réception.
- 2) Relocaliser le four à micro-ondes relativement au récepteur.
- 3) Brancher le four à micro-ondes à une prise différente de celle du récepteur pour que le four à micro-ondes et le récepteur s'alimentent à des circuits électriques différents.

Au besoin, l'utilisateur devrait consulter son fournisseur ou un technicien radio/télévision expérimenté pour obtenir des suggestions supplémentaires.

Remarque : les modifications ne doivent être effectuées que par le fabricant ou par un représentant autorisé pour assurer le maintien de la conformité.

Cet appareil est conforme à la Section 18 des règlements de la FCC.

QUICK START GUIDE: QUICK SERVICE OVEN

The easyToUCH screen display, layout and icons shown herein are for guidance purposes only and are not intended to be an exact representation of those supplied with the oven.

START UP

1. Switch the oven on.

Make all the relevant safety checks and ensure the oven is clean and empty before pressing the oven switch down to activate the oven.

2. The easyToUCH screen illuminates with the display briefly showing the serial number and oven data. If required, to keep the data on the screen, lightly tap the screen once to freeze the display. Tap again to continue.

3. When the oven is setup with two or more preheating temperatures a choice is displayed. Scroll arrows at the bottom of the screen indicate there are more temperature choices not shown on screen. If necessary, use the scroll arrows, then select the temperature required to start preheating the oven.

4. During preheating the display shows the progress as the oven heats up to the set temperature (to stop the oven heating touch the red 'X' symbol).

5. The oven is ready to use when the 'COOKBOOK' is displayed.

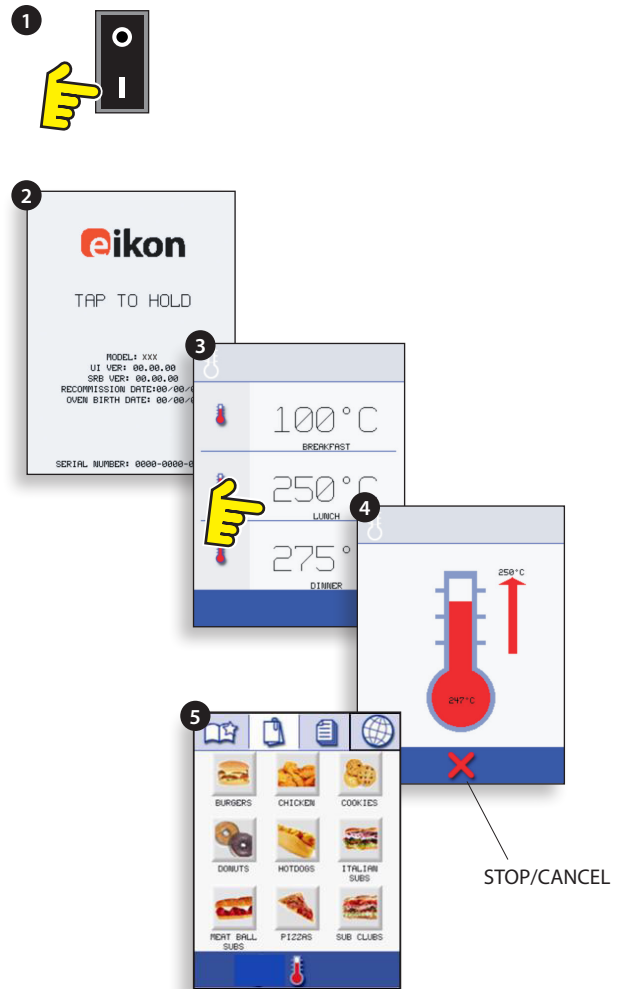

COOKBOOK DISPLAY

- MULTIPLE LANGUAGES INSTALLED
- DISPLAYS ALL COOKING PROGRAMS (Optional)
- SHOWS PROGRAM GROUPS
- FAVOURITES (Optional)

PROGRAM GROUP
Each group contains a collection of cooking programs.

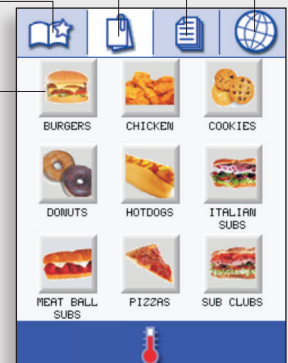

CHANGE OVEN TEMPERATURE
(Optional)

USING A COOKING PROGRAM



Taking all the necessary precautions to ensure you do not burn yourself, open the oven door to place the food into the hot oven and close the door.



Prenant toutes les précautions nécessaires pour éviter les brûlures, ouvrir la porte du four pour y placer les aliments et fermer la porte.

1. Select a program group, for example 'BURGERS', to display the individual cooking programs.
2. Select a cook program to start, for example '2 BURGERS':
3. Follow instructions if displayed on the screen.
4. Touch the green tick to cook.

The cooking time counts down for each program stage.

5. When the program ends a red bar is displayed usually with an audible sound -- open the door or touch the red 'X' to return to the cook program.

Note: Opening the oven door during cooking stops the cooking program and displays a warning. Closing the door allows the user to continue or cancel the cooking program.



AIR FILTER

IMPORTANT:

Clean the AIR FILTER (6) in the base of the oven every day and ensure that the air filter is in place prior to operating the oven. See 'CLEANING & MAINTENANCE'.

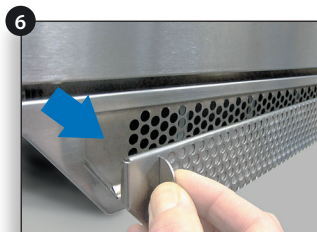

SCREEN SAVER

An active screen saver will mask the screen showing a moving image. To use the touchscreen, tap the screen to deactivate the screen saver.



OPERATING GUIDE: FULL SERVICE OVEN

easyToUCH MAIN MENU & KEYBOARD SCREEN

MAIN MENU SCREEN:

1. DEVELOPMENT MODE enables multistage cooking programs to be developed, then stored under a name and symbol for reuse.
2. PRESS & GO allows quick access to use the cooking programs that are already stored.
3. COOKBOOK contains the oven's cooking programs. It displays Favourites, Cooking Program Groups and a complete listing of all cooking programs available.
4. CLEANING/TEMP CHANGE allows the oven temperature to be changed and the oven to be prepared for cleaning with reminders displayed to assist during the cleaning process.
5. SETTINGS are used to control the oven settings and functions including time and language, loading cooking programs and for service and maintenance purposes.
6. KEYBOARD SCREEN is used to enter an authorised password to enter data for programs and may restrict operator access to some functions.

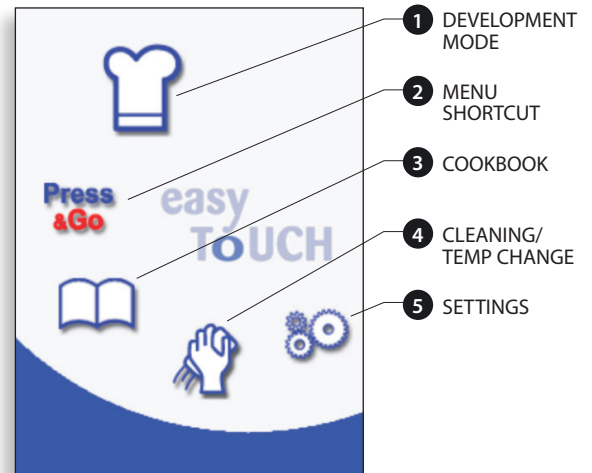

- i** For Program Names, Program Group Names and Passwords use 1-20 characters in 2 lines max.
- For Stage instructions use 1-54 characters in 5 lines max.

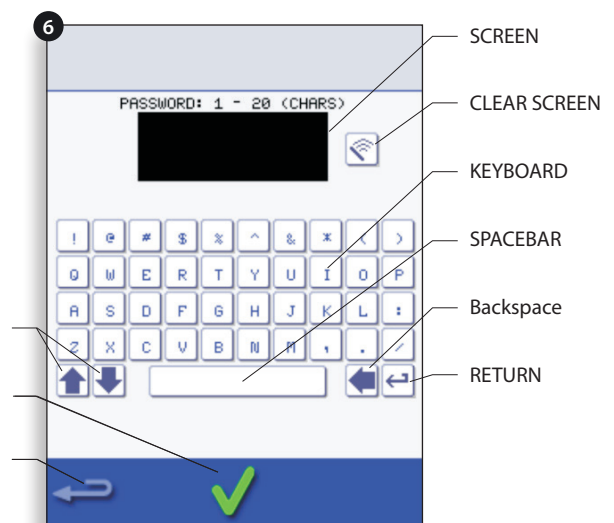

DEVELOPMENT MODE: CREATING A COOK PROGRAM

1. Select the 'chef's hat' symbol from the main menu to enter development mode.

Enter stage 1 of the program

2. The temperature displays the set preheated oven temperature.

To increase or decrease the temperature required, select the temperature symbol (2), enter the temperature in the keypad within the limits displayed and select OK.

3. Select and set the cooking time up to a maximum of 10 minutes for each stage.

For example: Enter 110 (1 minute and 10 seconds).

4. Select and set the Microwave Power [0,5-100%]

5. Select and set a fan speed (if available) within the limits shown on screen.

6. Select the information icon to enter an instruction (optional). The instruction appears in the display at the beginning of that stage.

For example: 'Stage 1 place product in the oven.'

Enter stage 2 of the program (optional).

7. Programs can have up to a maximum of 6 stages. Repeat the steps 2-6 from stage 1 above.

Running and saving the program

1. Select OK to confirm the program.

2. Run the program (optional).

If the results are not satisfactory, select the backspace, change the cooking settings and retest.



WARNING: ENSURE PRODUCT IS IN THE OVEN AND ALL SAFETY PRECAUTIONS ARE FOLLOWED BEFORE RUNNING THE PROGRAM.



AVERTISSEMENT: S'ASSURER QUE LES ALIMENTS SONT DANS LE FOUR ET QUE TOUTES LES PRÉCAUTIONS SÉCURITAIRES SONT PRISES AVANT

3. Select the save cookbook symbol to record the program to the cookbook.

4. Select the camera icon to open pictures.

5. Select a picture to represent the program (use the scroll arrows for more pictures).

6. Enter the name for the cooking program, using a maximum of 20 characters, for example, '1 BURGER', then select OK to save the program to the cookbook.

A green tick on a book icon indicates the program has been saved to the cookbook.



Example below; setting the cooking time (step 3):

To set the cooking time select the Time symbol.

Enter the cooking time on the pad.

Select OK to accept the time.

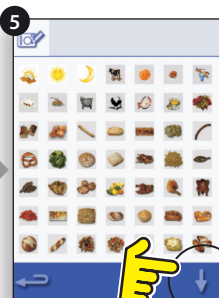
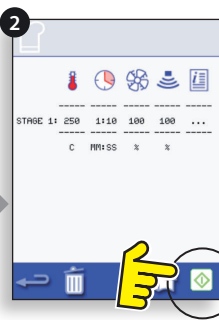
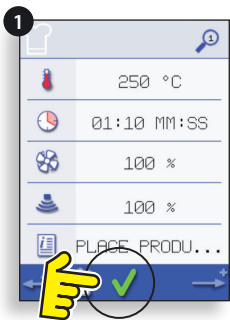
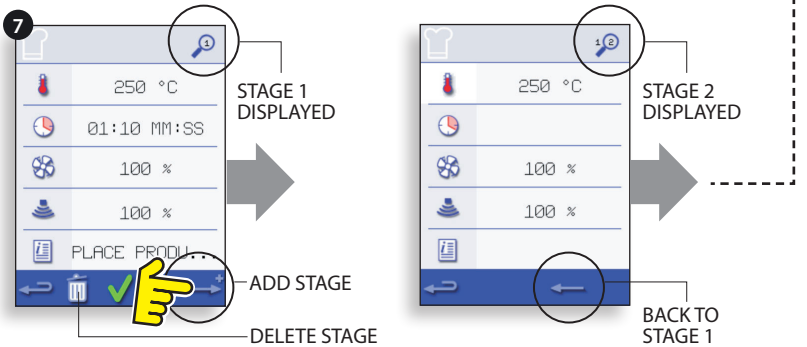
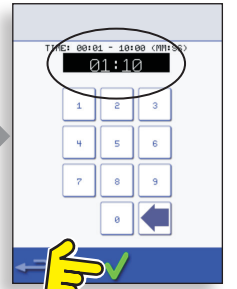
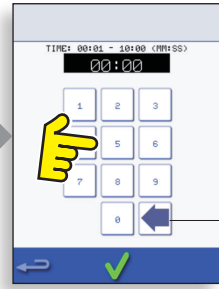

PRESS & GO

Running a cooking program from the Press & Go menu.

1. Select 'PRESS & GO' from the main menu screen.
2. Select the item required to cook.
3. The display shows the cooking time count down. The timer bar turns red to indicate the cooking cycle has finished.

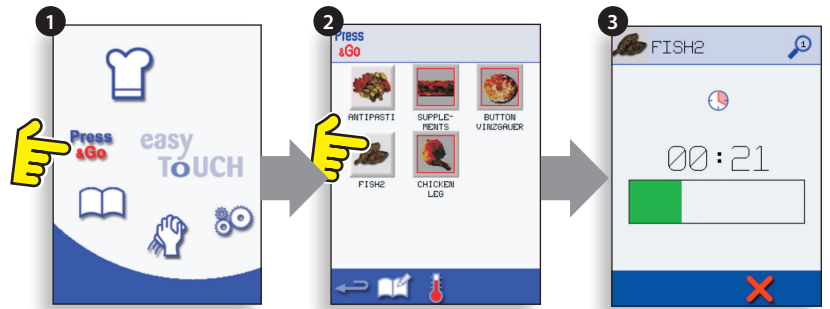

Choosing which cooking programs are shown in the 'PRESS & GO' menu screen.

1. After selecting 'PRESS & GO' from the main menu screen, select the EDIT symbol.
2. Two lists are displayed, the 'PRESS & GO' menu items are shown in the upper list and the lower list shows other menu items which are available. Both lists can be scrolled up or down using the arrows on the extreme right.
3. Select an item, then choose whether to change its order within the menu or to remove it into the lower list.
4. Select an item to move into the upper list, making it available in the 'PRESS & GO' menu.
5. Select backspace to return to the menu screen when finished.

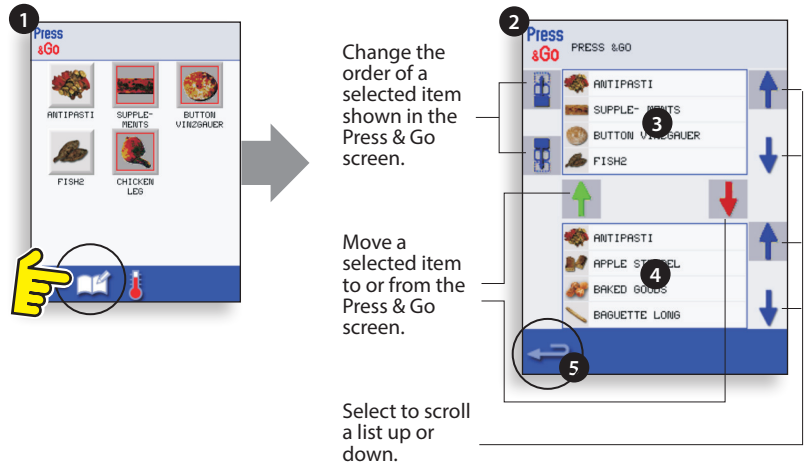

USING A COOKBOOK PROGRAM

To find the required program in the cookbook.

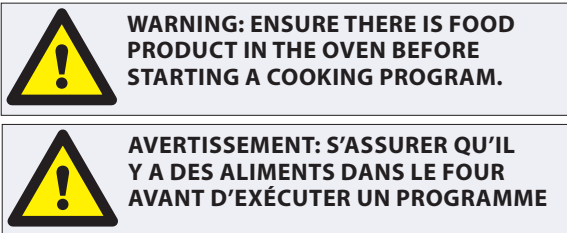

1. Select 'COOKBOOK' from the main menu screen.
 2. Select the ALL MENUS symbol.
 3. Use scroll up/down arrows to find the program.
- NOTE: If an image has a red line around it the oven temperature is set too high or too low for that recipe. See 'CHANGING THE OVEN TEMPERATURE'.

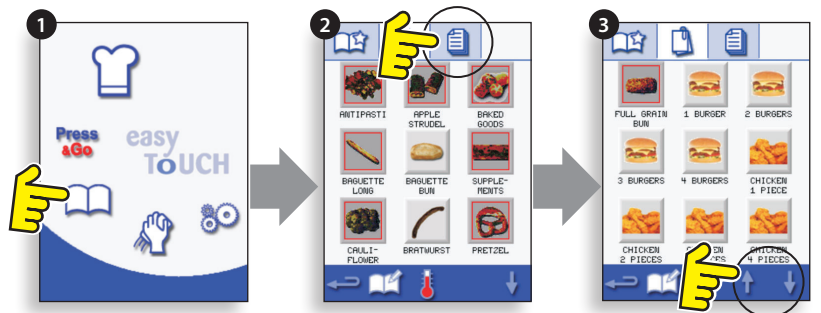
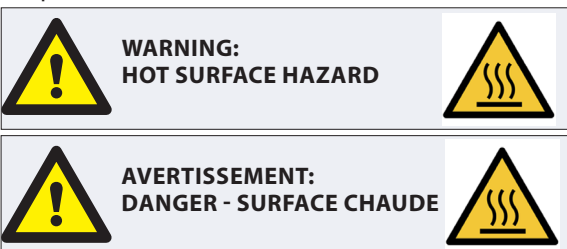

Taking all the necessary precautions to ensure you do not burn yourself, place the food product into the hot oven cavity and close the door.

4. Select the required cooking program to start cooking. For example, '1 BURGER'.

5. The program either starts immediately displaying a countdown timer, or an instruction is displayed first. Follow the stage instruction and then select OK to start cooking. If the oven door is not opened within 30 seconds a warning message appears.

6. The cooking timer counts down to zero and makes a sound to indicate an operator action is required at the end of a cooking stage or the end of a cooking program.

Once the cooking program has finished, opening the oven door to remove the food returns the display to the 'COOKBOOK' screen.

NOTE: Opening the oven door during cooking stops the cooking program and displays a warning. Closing the door allows the user to continue or cancel the cooking program.

To check the oven temperature when cooking, lightly tap the temperature displayed, the oven cavity temperature is shown with an asterisk.

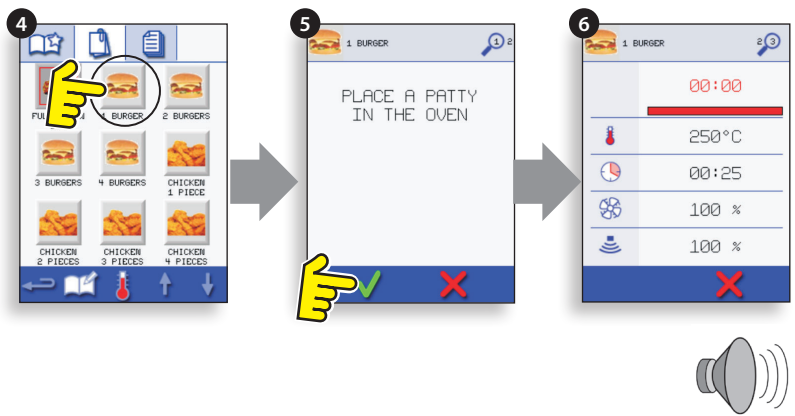

CHANGING THE OVEN TEMPERATURE

1. Take note of the temperature required for the recipe and select OK.

2. Select the temperature symbol.

3. An asterisk next to the number indicates the present oven temperature, select the required oven temperature for the recipe. Once the oven is at the required temperature continue from selecting the 'COOKBOOK' in step 1.

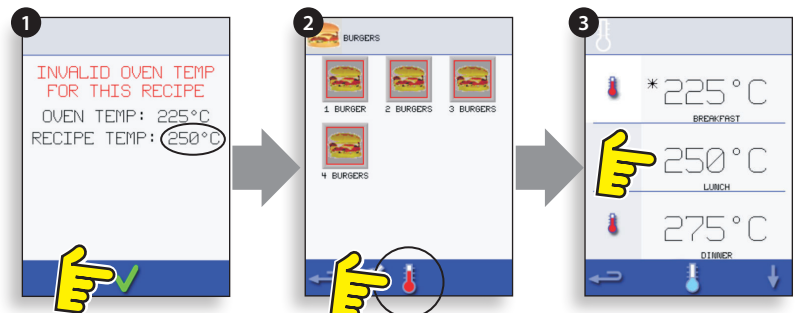

VIEWING & EDITING PROGRAMS

1. Select 'COOKBOOK' from the main menu screen.

2. Select the ALL MENUS symbol.

3. Select 'EDIT COOKBOOK'.

4. Use the up/down scroll arrows on the right side of the screen to find the cooking program, for example '1 BURGER' and select the view/edit cooking program symbol.

5. View or adjust the program as required, see Development Mode for details.

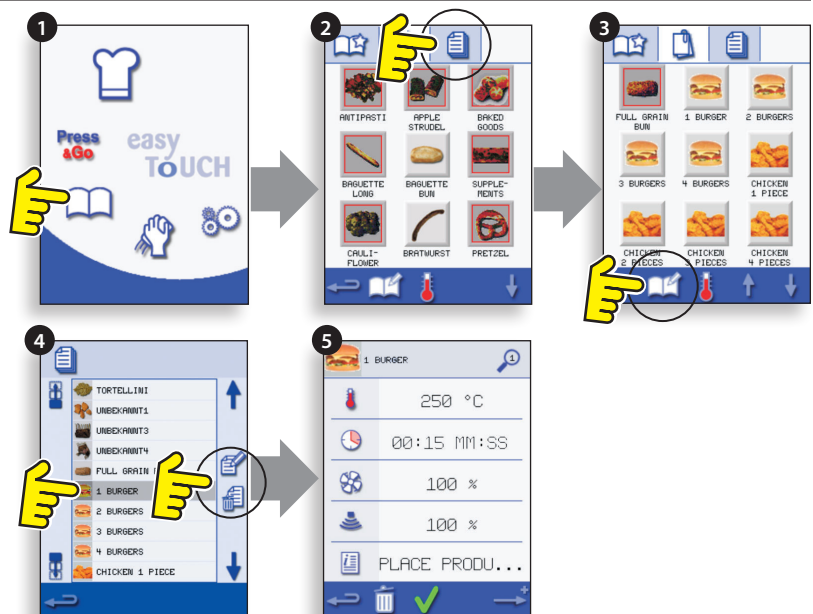

ADDING A NEW PROGRAM GROUP

To add a new program group.

1. Select 'COOKBOOK' from the main menu screen.
2. Select 'EDIT COOKBOOK':
3. Select the 'ADD A NEW GROUP' symbol.
4. Select the camera icon to open pictures.
5. Select a picture to represent the program group (use the scroll arrows for more pictures).
6. Enter a name for the new program group (max. 20 characters) and select OK to save the program group to the cookbook.

Select backspace to return to the 'COOKBOOK'.

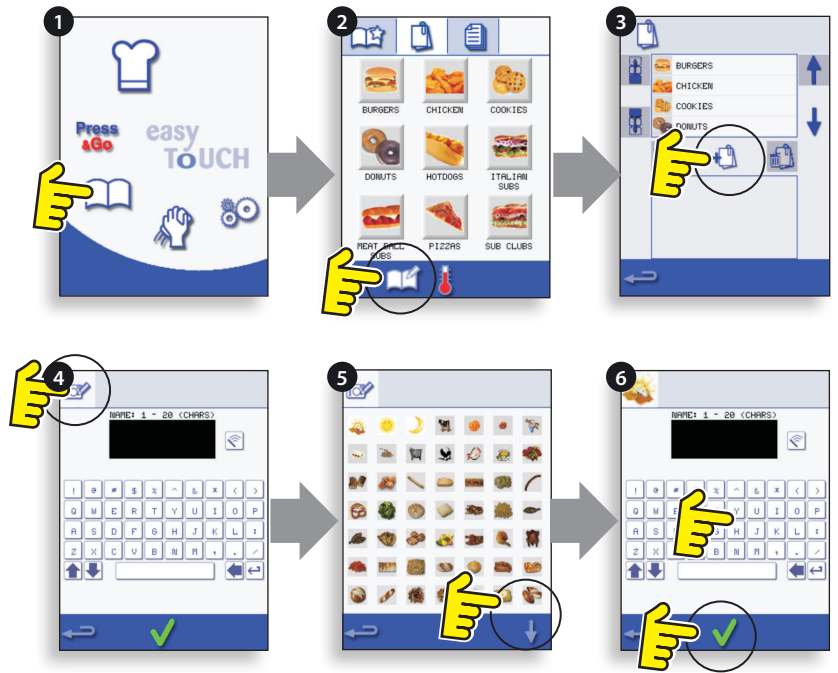

MOVE A PROGRAM WITHIN A PROGRAM GROUP

Example: Moving the position of the '4 BURGERS' cooking program within the program group called 'BURGERS'.

1. Select 'COOKBOOK' from the main menu screen.
2. Select the 'BURGERS' program group.
3. Select 'EDIT COOKBOOK':
4. Use the up/down scroll arrows on the right side of the upper part of the edit screen to view the cooking programs in the group. Then select the cooking program to be moved ('4 BURGERS') and use the up/down arrows on the left side of the upper screen to move the selected program within the program group.

Select backspace to return to the 'COOKBOOK' screen.

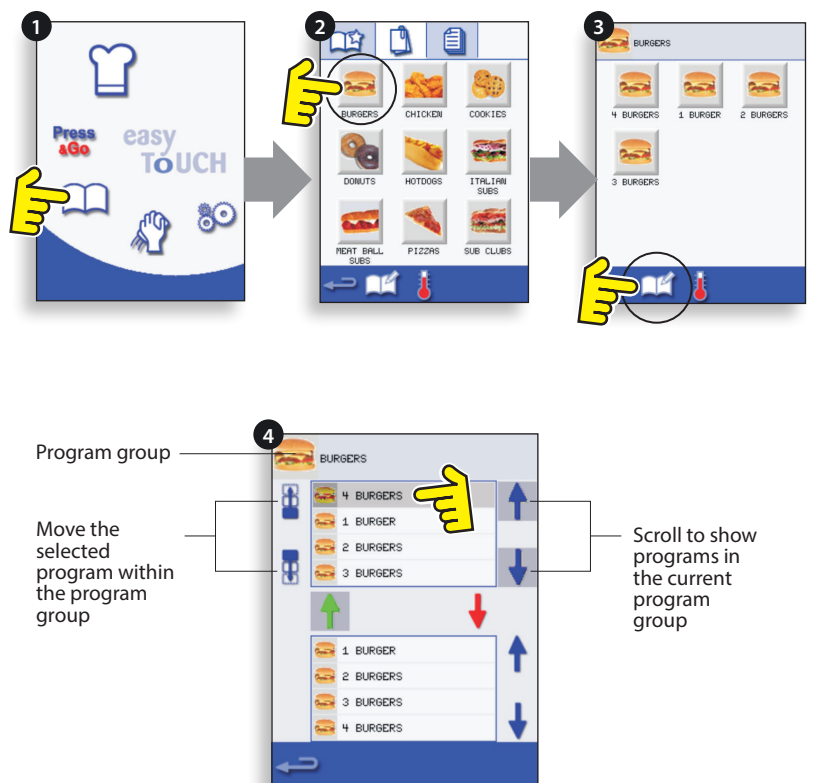

ADDING A PROGRAM TO A GROUP

To add a cooking program to an existing PROGRAM GROUP.

Example: Add program '4 BURGERS' to the program group 'BURGERS'.

1. Select 'COOKBOOK' from the main menu screen.
2. Select the 'BURGERS' program group.
3. Select 'EDIT COOKBOOK'.
4. In the lower part of the screen use the up/down scroll arrows on the right side to find and select the '4 BURGERS' cooking program.
5. Select the green UP arrow to add the '4 BURGERS' cooking program to the program group in the upper part of the screen, then select backspace to return to the cooking programs.
6. Select backspace again to return to the 'COOKBOOK'.

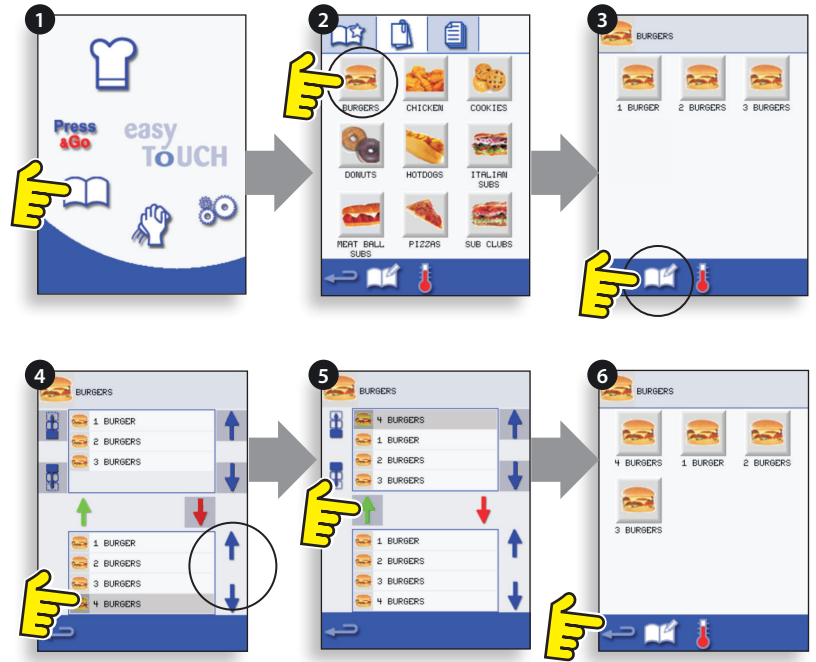

MANAGING PROGRAM GROUPS

To move a program position in a program group

1. Select 'COOKBOOK' from the main menu screen.
2. Select 'EDIT COOKBOOK'.
3. Use the scroll arrows, up and down on the right side of the screen to locate all the program groups.
4. Select the program group to be moved and use the up and down arrows on the left side of the screen to move the selected program.
5. Select backspace to go back to the 'COOKBOOK'.

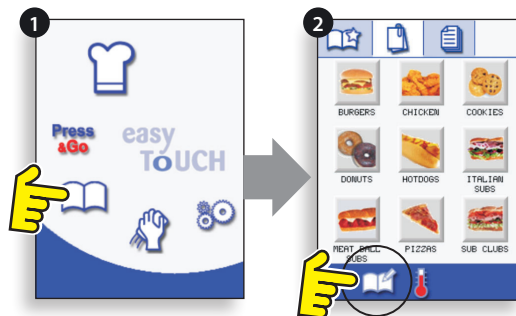

To change the program group name.

- Select the program group.
- Select EDIT PROGRAM GROUP.
- Enter the new name and select OK.

To delete a program group

- Select the program group.
- Select the DELETE program group symbol.
- Select OK to delete the program group.

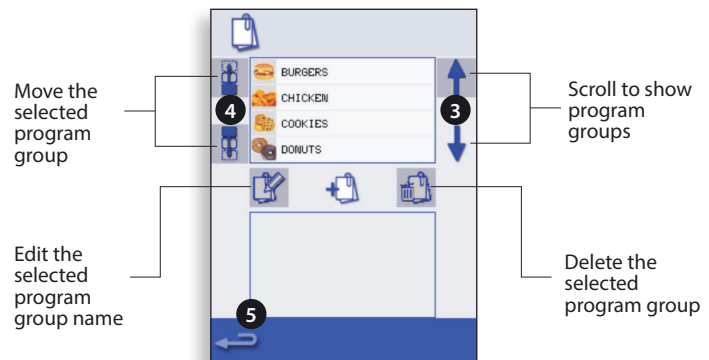

OVEN CONTROL SETTINGS

1. Select the 'settings' symbol from the main menu screen.

2. Enter the password and select OK to display the Settings menu (3) comprising:

- A. Oven mode/navigation settings.
- B. Language options.
- C. Oven temperature settings and labels.
- D. Service information and error logs (password required).
- E. Recipe counters.
- F. Date & time settings.
- G. Speaker sound levels.
- H. Oven Timer (Temperature/ON/OFF).
- J. USB program connection.
- K. Temperature Band.
- L. Change Settings/Service access passwords.
- M. Screen saver.

When finished with a setting, select backspace to return to the main settings menu.

To exit the settings menu, select backspace, a prompt will be displayed to either 'SAVE' or 'DISCARD' any changed settings (4).

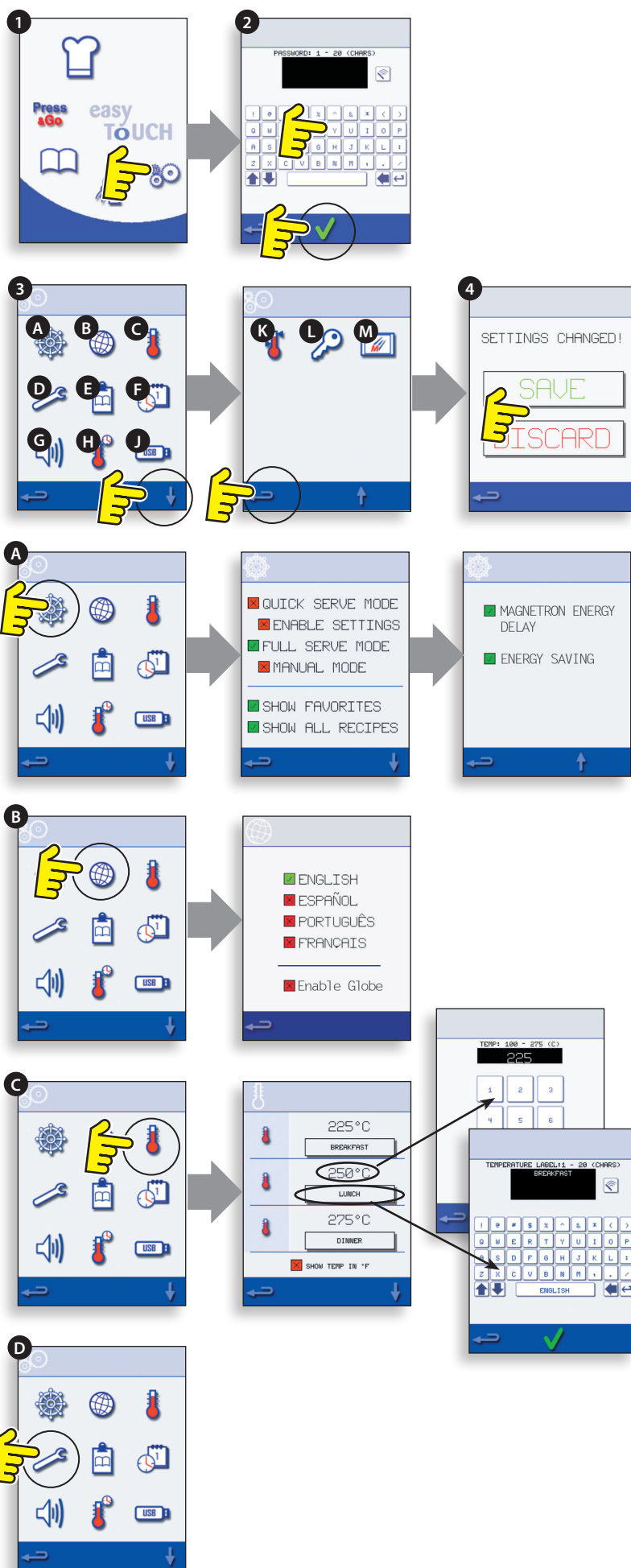

Oven mode/navigation settings (A)

Select the oven mode/navigation symbol (A) from the 'Settings' menu.

Select 'Quick Serve Mode' for cooking only, or 'Full Serve Mode' for cooking & development programs or 'Manual mode' to manually cook only via the 'Chef's hat' symbol.

Select 'Enable Settings' to display an 'unlock' symbol on the Quick Serve Mode screen to allow access to the 'Settings' menu.

Language options (B)

Select the 'Globe' symbol (B).

Select the checkbox of the required language/s from the list shown.

Select the 'Enable Globe' checkbox to display the 'Globe' icon in the menu screens to select a preset language.

Oven temperature settings and labels (C)

To change the oven preheat temperature, select the temperature symbol (C) to display the keypad. Enter the required temperature and select OK.

Note: The temperature options screen is only displayed at start up when two or more temperatures are set above minimum.

To change a temperature label, select the label to display the keyboard, enter the required label name and select OK.

For Service information & error logs (D) refer to Servicing.

Recipe counters (E)

Select the clipboard symbol to display a listing of recipe counters.

If shown, use the arrows (bottom right) to scroll up and down the list.

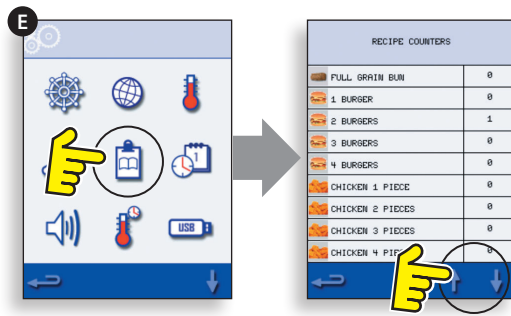

Date and Time settings (F)

Select the time/date symbol to display the setting options.

CHANGE THE DATE: Select 'MONTH', enter the correct month on the keypad and select OK.

Select 'DAY', enter the correct day on the keypad and select OK.

Select 'YEAR', enter the correct last two digits of the year on the keypad and select OK.

To display the month first, followed by the day and year, select the 'MM-DD-YY' checkbox. Note: The error logs are recorded using these settings.

CHANGE THE TIME: Select 'HOUR', enter the correct hour on the keypad and select OK.

Select 'MIN', enter the correct minutes on the keypad and select OK.

Select the day name shown to cycle through to display the correct weekday.

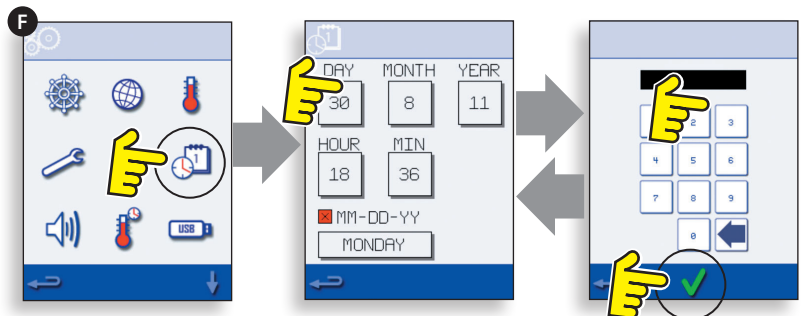

Sound levels (G)

Select the speaker symbol to adjust the volume level suitable for the environment from none (OFF) to the loudest (100%).

Select music note symbol to set LOW, MED or HIGH tone.

Select the keypad symbol to switch the sound ON or OFF when the touchscreen is pressed.

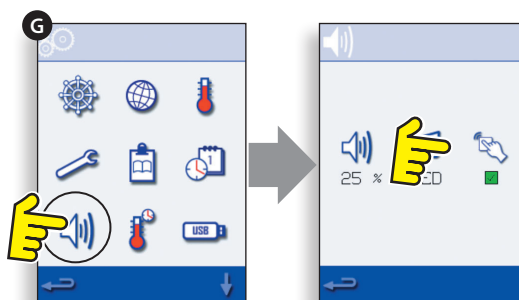

Oven Timer (H)

Select the thermometer/timer symbol.

Select the 'Timer Enabled' checkbox (green tick).

Select a weekday using the up/down arrows.

Select an empty 'Time' box (maximum of 5 per day) or clear the box using the wipe symbol.

Enter the start time on the keypad and select OK.

Select an empty 'Temperature' box opposite the time box displaying the time just entered, or clear the box using the wipe symbol next to it.

Enter the cavity temperature required on the keypad and select OK. Note: You can also select zero to turn the heat off. Selecting the red circle symbol will switch the oven OFF.

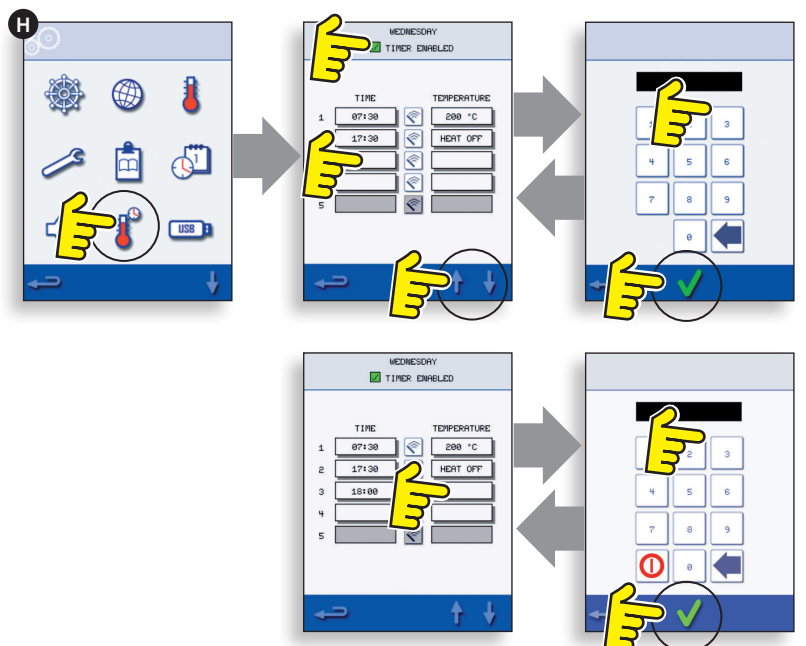

USB oven programs (J)

IMPORTANT: Downloading from a USB will clear all the existing programs.

Check that the key has the correct number/code for the programs you want to load into the oven memory (1 'cbr' + 'autoupd.ate').

With the oven switched off, slide the Merrychef badge (oven front top right) upwards and insert the USB Memory Stick into the slot.

Switch the oven ON.

The files automatically download from the USB showing the progress and confirmation screens for the update.

On completion the oven displays the start up screen, then the thermometer symbol is displayed.

Remove the USB and keep it in a safe place. Reposition the USB cover.

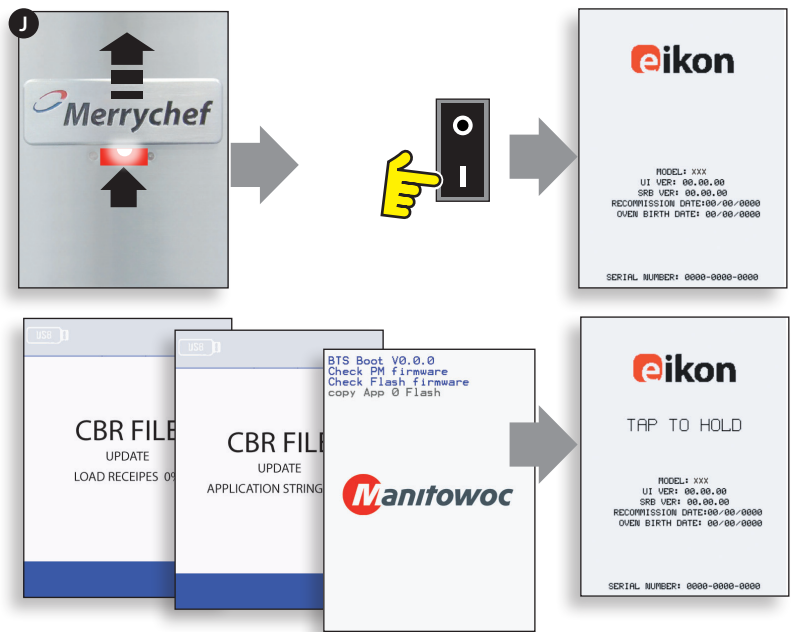

Temperature Band (K)

Select the 'Temp Band' symbol at which the oven controls, e.g. 50°C.

Select the required temperature band checkbox, shown by a green tick. Note: Although the lowest practical Temp Band should be used, if the set oven temperature falls by more than the selected Temp Band, the ready to cook mode and Temp Band are deactivated until the oven reaches the preheat temperature.

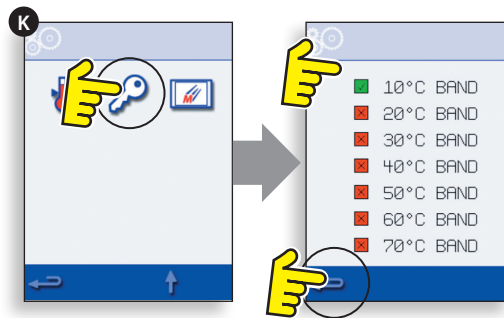

Change Password (L)

Select the key symbol to change the oven passwords.

Select the oven Settings or Service symbol.

Enter the existing password and select OK to confirm.

Enter the new password, select OK.

Confirm new password, select OK.

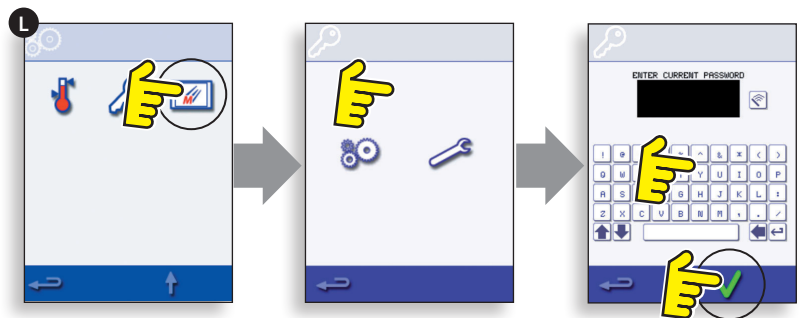

Screen saver (M)

Select the ENABLED checkbox to switch the screen saver ON or OFF.

Select the time box below to enter a time delay on the keypad from 1 to 60 minutes before the screen saver starts and select OK to confirm.

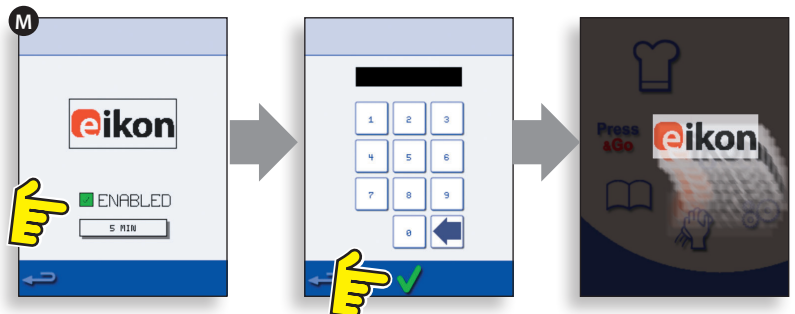

COOLING THE OVEN DOWN BEFORE CLEANING

Oven cool down

IMPORTANT: the oven must be cooled down before the cleaning processes are carried out.

1. In Full Serve mode, select the CLEANING symbol from the main menu.
2. In Full or Quick Serve mode, select the blue thermometer symbol to disable heating and start the cooling cycle.
3. Taking all necessary precautions place a suitable container of ice or cold water (to speed up the cooling process) into the hot oven cavity. Select the OK symbol to continue.
4. The cooling progress is displayed and takes approximately 30 minutes. Note that the oven will continue to cool should the door be opened during the cool down procedure.
5. Once the cooling process is complete, carefully remove the cool down pan. The pan and water maybe hot so an oven cloth or gloves should be used.
6. The oven is now ready for cleaning. Select OK on the screen after completing each stage.

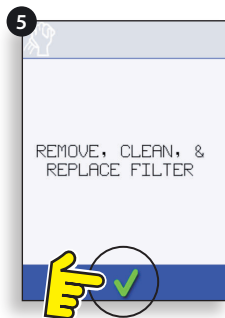
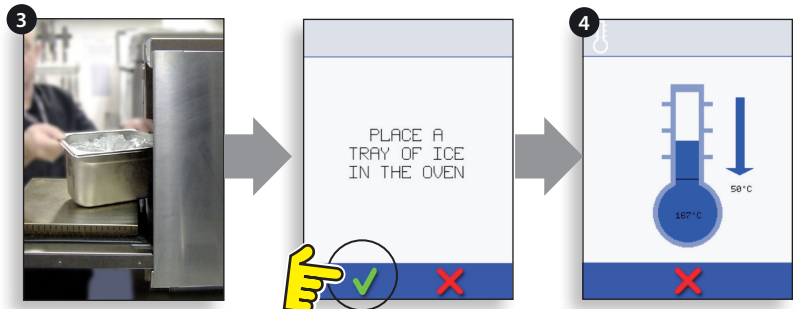
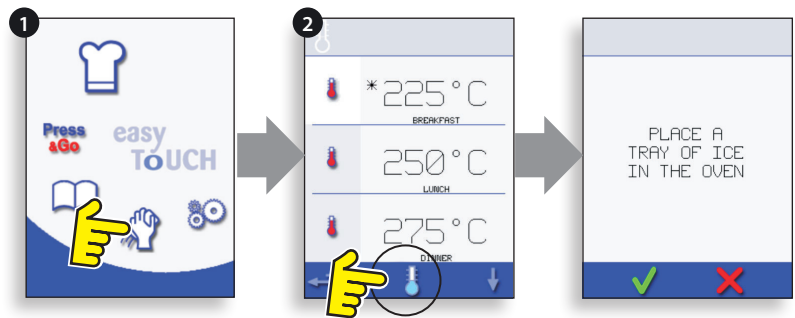

Preparing to clean the oven

For the oven to operate at peak efficiency, the cavity, door, air filter and grease filter must be kept clean.

A daily cleaning routine will ensure that you comply with the required hygiene standards and will help to maintain and prolong the efficiency of your oven.

Equipment required (not supplied):

Non-caustic proprietary branded oven cleaner, heat proof gloves, protective rubber gloves, non-abrasive nylon scrub pad, cleaning towel and cloths, eye protection and dust mask (optional).

CAUTION: WEAR PROTECTIVE RUBBER GLOVES WHEN CLEANING THE OVEN.

NEVER use sharp implements or harsh abrasives on any part of the oven.

AVERTISSEMENT: PORTER DES GANTS PROTECTEURS DE CAOUTCHOUC POUR NETTOYER LE FOUR.

NE JAMAIS utiliser d'outils pointus ou des abrasifs rudes sur aucune partie du four.

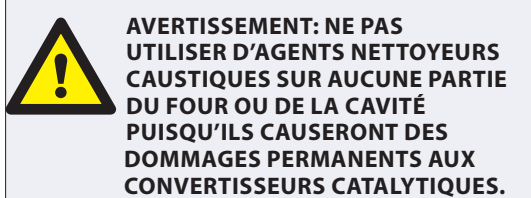
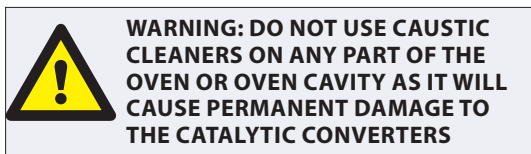

Complete COOL DOWN procedure and allow the oven and accessories to cool before commencing cleaning.



DO NOT USE TOOLS



NE PAS UTILISER D'OUTILS

REMOVE & CLEAN Oven Parts:

1. Remove the air filter at the base of the oven.
2. Open the oven door and remove the rack & air diffuser.
3. Lift out bottom impinger plate.

Wash all parts in warm soapy water. Wash off using a clean cloth and plenty of clean, warm water.

Dry using a fresh, clean cloth.

CLEAN THE OVEN:

1. Remove any spillages with suitable cloth/paper towel. Use a dry clean brush to remove any food particles from between the oven floor and the inside of the front door.
2. Wear protective rubber gloves and protective glasses following manufacturers recommendations, carefully spray a non-caustic Merrychef branded oven cleaner onto all the internal surfaces of the oven except the door seal (A).

DO NOT spray directly into the fan opening at the rear inside of the oven.

3. For difficult areas, leave to soak for 10 minutes with the oven door open.

Use a non-abrasive nylon scrub pad/sponge to clean the cavity, roof and the inside of the door. Do not scrub the door seal or use metallic scourers.

4. Wash off using a clean cloth and plenty of clean warm water and dry using a fresh clean cloth or paper towel. Ensure all components are dry before re-fitting them.

5. Replace all the cleaned oven parts.

6. Close the oven door and wipe the outside of the oven with a damp cloth.

7. Now press the green tick.

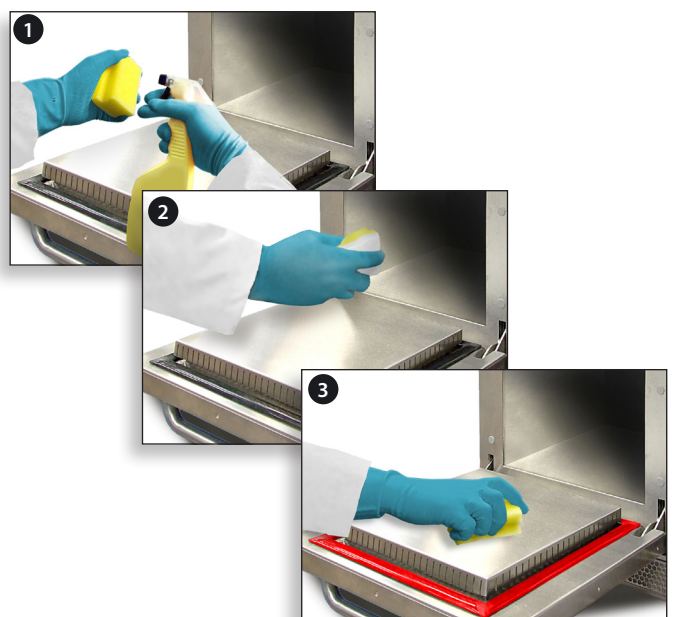
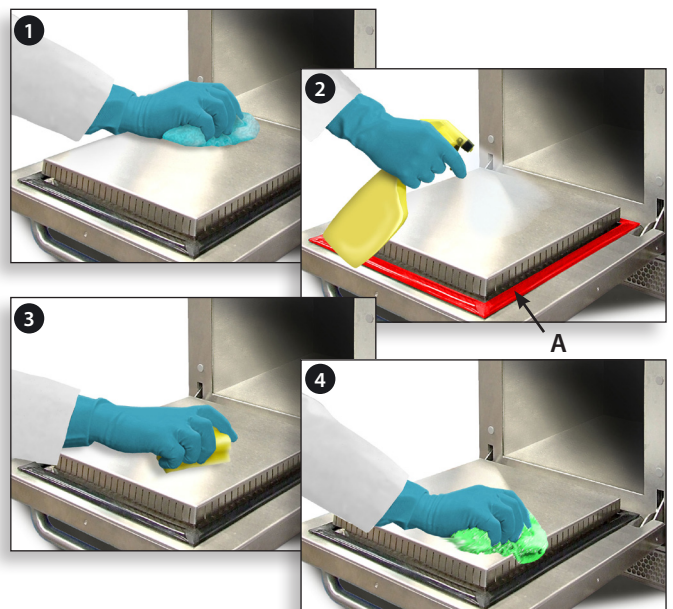

DO NOT USE THE OVEN WITHOUT A CLEAN AIR FILTER IN PLACE



NE PAS UTILISER LE FOUR SANS AVOIR UN FILTRE À AIR PROPRE EN PLACE

APPLY OVEN PROTECTOR:

1. Only apply to a clean oven. Spray Merrychef branded oven protector onto a sponge.
2. Spread oven protector lightly onto all internal surfaces of the oven avoiding cooking surfaces, fan inlets and outlets.
3. Spread oven protector lightly onto the internal surface of the oven door avoiding the door seal.
4. Close the door and switch on the oven. If the air filter has not been replaced the touch screen will display a warning. Replace the air filter and then press the green tick.
5. Preheat the oven, once the oven has reached operating temperature. It will take about 30 minutes to cure the oven protector.

Note: Oven protector turns light brown when cured.

FAULT FINDING CHART

Although every effort is made to ensure your oven will continue to perform to a high standard, please check the chart to see if the problem can be easily resolved before contacting your service agent.

PROBLEM	POSSIBLE CAUSE	REMEDY
The oven does not work and the display screen is blank	The oven has no power	Check if there is a power cut. Check the isolator switch is ON or the oven is plugged in correctly. Check the oven switch is ON.
Some screen controls do not work	Unauthorised access	Contact the authorised user.
Display shows a warning message	Details are shown on screen	Follow the instructions displayed.
The oven does not cook the food correctly	Oven not clean Food not at correct temperature Modified or wrong program selected Food wrapped Food removed early	Clean the oven (see cleaning). Use the correct cooking program. Unwrap food for non-microwave cooking. Check all the cooking stages have been followed correctly.
The oven does not finish cooking	Warning message displayed Oven door opened No air filter or incorrectly fitted Oven overheating	Close oven door. Refit air filter. Allow the oven to cool down. Check and remove any restrictions around the air vents.
Display shows an error code	Oven malfunction	Note the error code and contact your Service Agent.

SERVICING

Approved Service Agent;



Merrychef USA

1111 North Hadley RD

Fort Wayne

IN 46804 USA

Phone: 877/404 - 6872

Fax: 800/285 - 9511

e-mail:

info@merrychefusa.com

www.merrychef.com

Merrychef reserves the right to change product specifications without notice and accepts no liability for any inaccuracies, errors or omissions contained herein.