



Limited One Year Warranty
T&S warrants to the original purchaser (other than for purposes of resale) that such product is free from defects in material and workmanship for a period of one (1) year from the date of purchase. During this one-year warranty period, if the product is found to be defective, T&S shall, at its options, repair and/or replace it. To obtain warranty service, products must be returned to...

T&S Brass and Bronze Works, Inc.
Attn: Warranty Repair Department
2 Saddleback Cove
Travelers Rest, SC 29690

Shipping, freight, insurance, and other transportation charges of the product to T&S and the return of repaired or replaced product to the purchaser are the responsibility of the purchaser. Repair and/or replacement shall be made within a reasonable time after receipt by T&S of the returned product. This warranty does not cover items which have received secondary finishing or have been altered or modified after purchase, or for defects caused by physical abuse to or misuse of the product, or shipment of the products.

Any express warranty not provided herein, and any remedy for Breach of Contract which might arise, is hereby excluded and disclaimed. Any implied warranties of merchantability or fitness for a particular purpose are limited to one year in duration. Under no circumstances shall T&S be liable for loss of use or any special consequential costs, expenses or damages.

Some states do not allow limitations on how long and implied warranty lasts or the exclusion or limitation of incidental or consequential damages, so the above limitations or exclusions may not apply to you. Specific rights under this warranty and other rights vary from state to state.

P/N: 098-003758-45 Rev.2
Date: 10-15-04
Drawn: TEH
Checked: DLT 10-27-04
Approved: MVW 11-01-04

Installation and Maintenance Instructions



B-2850 & B-2865 and B-2990 & B-2991 Series Concealed Body - Widespread Lavatory Faucets

**Deutsch: Installations- und
Wartungsanleitungen**

**Español: la Instalación y las
Instrucciones de
Mantenimiento**

**Français: les Instructions
d'Installation et
d'Entretien**

Exploded View

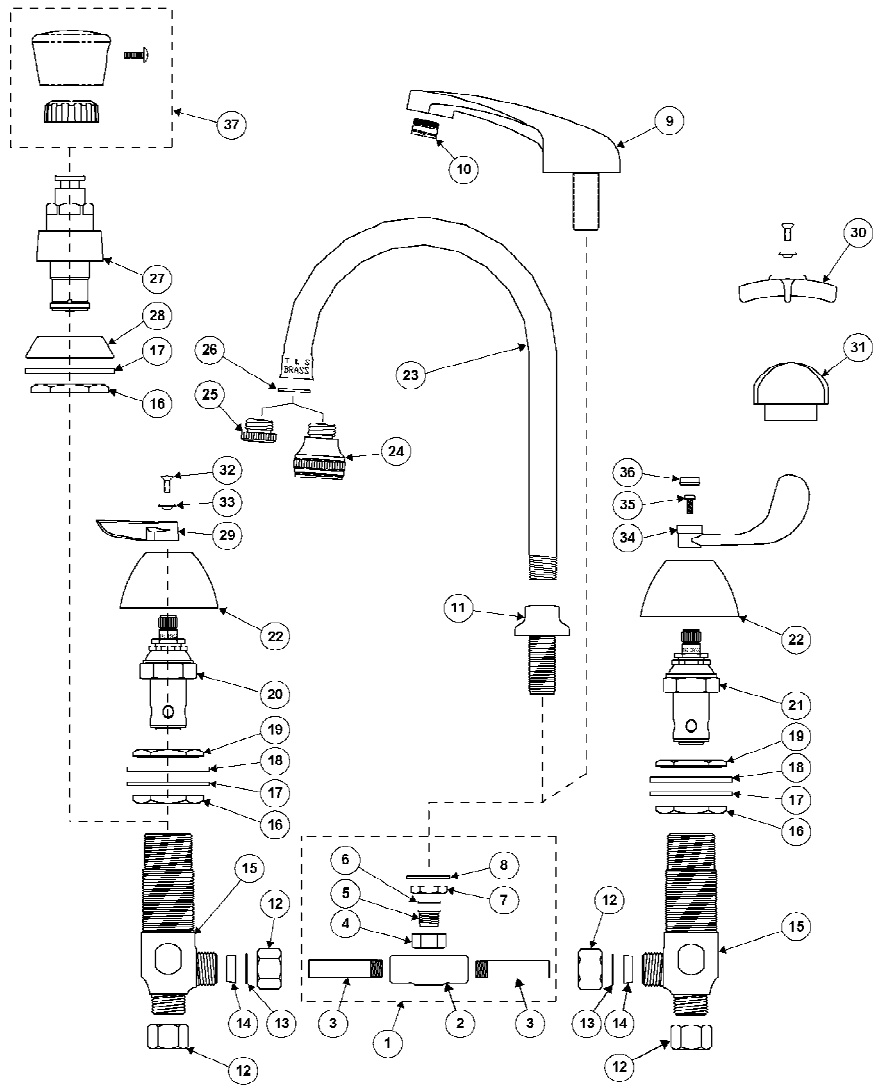

* Some items are listed for instructional purposes and may not be sold as separate parts.

Part Number Guide

Faucet Assemblies

1	Asm, 8" CC Rigid Gooseneck Cross	012622-40
2	Cross, Body	*
3	Nipple	000342-20
4	Coupling	*
5	Insert	*
6	Washer, Cross Body	*
7	Locknut	002954-45
8	Washer, Shank	012596-45
9	Asm, Rigid Spout & Shank	012602-40
10	Aerator	B-0199-03
11	Center Body	*
12	Coupling Nut	000958-20
13	Washer	000981-45
14	Washer, Bevelled	001091-45
15	Faucet, Side Body	*
16	Locknut, Body Bottom	000960-20
17	Washer, Nipple	001006-45
18	Washer, Body	002290-45
19	Locknut, Body Top	000959-20
20	Asm, Eterna RH Spindle	006478-40
21	Asm, Eterna LH Spindle	006477-40
22	Escuteon	001257-45
23	Asm, Gooseneck w/ Tip	002980-40
	Gooseneck	000398-40
24	Rosespray	B-0103
25	Tip	000861-25
26	Washer	001043-45
27	Asm, Push Button Metering Cart.	238AB
28	Flange	000537-40

Handle Assemblies

29	Lever Handle	001638-45
30	Four Arm Handle	002521-45
31	Dome Handle (Cold)	001784-40
	Dome Handle (Hot)	001783-40
32	Screw, Lever Handle	000922-45
33	Index, Blue (Cold)	001660-45
	Index, Red (Hot)	001661-45
34	Wrist Action Handle, 4"	000078-40
	Wrist Action Handle, 6"	000079-40
35	Screw, Handle	000925-45
36	Index, Snap-In, Blue (Cold)	001686-45
	Index, Snap-In, Red (Hot)	001194-45
37	Push Button Cap, Blank	014193-40
	Push Button Cap, Hot	014194-40
	Push Button Cap, Cold	014195-40

General Instructions

Installation:

Center body and side bodies/faucet

1. Turn off water supply and drain lines. Drill (3) three holes in sink or countertop where you are installing no.1. See illustration below:

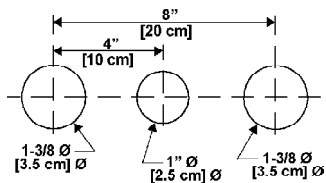

2. Remove no.9/11 from no.2 by holding no.4 with a wrench, then twist no.9/11. Remove no.7 and no.8 from no.9/11. (No.3 should already be tight in no.2)

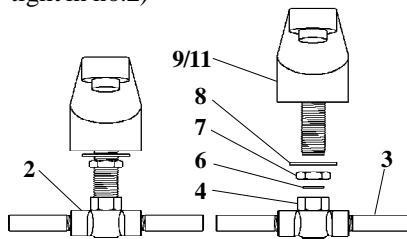

Hot and Cold Side Valves

3. Remove no.20/21, no.19, and no.18 from no.15. (No.17 and no.16 remain on no.15.)

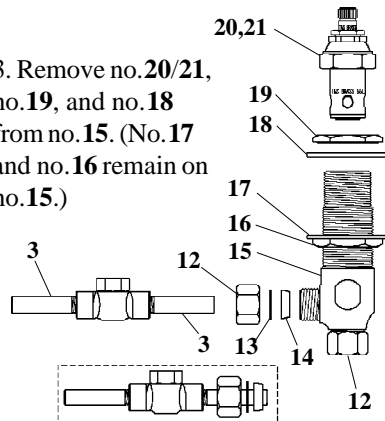

4. Remove no.12, no.13 and no.14 from no.15. Assemble previous items onto arm of no.3, as shown in illustration (below-left). **Both sides.**

5. Insert no.3 into no.15, loosely tighten no.12 onto threads by hand.

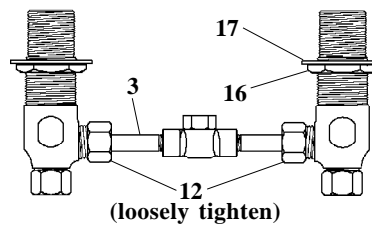

6. Place no.15 assembly into holes from underside of sink. Loosely assemble no.16, and no.17 under sink. Replace no.18 and no.19 onto no.15 at top of sink. Loosely tighten by hand. **Do this for both sides.**

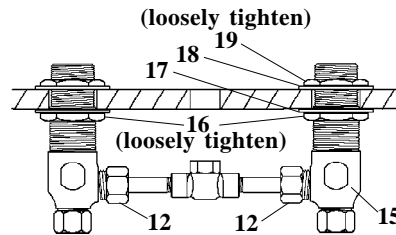

7. Place no.9/11 through hole in sink, and replace no.7 and no.8 onto no.9 from bottom of sink. Adjust no.16 and no.19 to allow proper positioning of no.9/11.

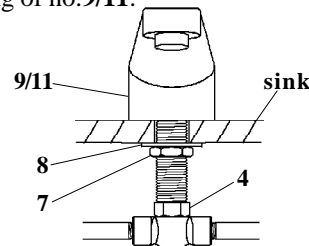

General Instructions

8. Reattach no.9/11 to no.4, making sure no.6 is in place.
9. Tighten no.7 with a wrench against sink bottom.
10. Tighten bottom no.16 on both side no.15 on underside of sink with a wrench. Also, tighten no.12 on no.15 assembly.

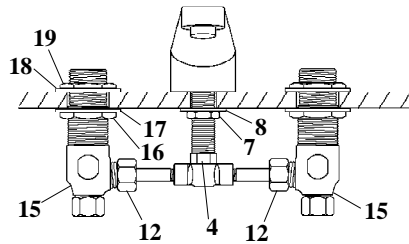

Note: When tightening no.7 and no.16, make sure that both no.15's are located at the same height above sink level. Tighten no.7 and no.16 before tightening no.19's

Valve Assembly

11. Replace no.20 and no.21 on both side no.15 and tighten bonnets sufficiently to seat valve.

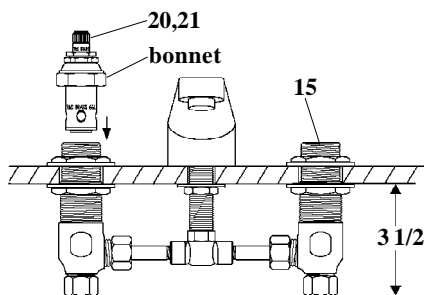

12. Remove *packing nut/locknut assembly* from both no.20,21.
13. Slip no.22 over each no.20,21.
14. *Packing nut and locknut* should be loosely assembled before replacing into no.20,21. Hand-tighten *locknuts only* against no.22. **Do not use a wrench.**

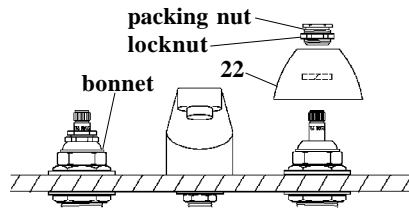

15. Tighten *Packing nut* down against *lock nut* using two wrenches. Hold *lock nut* while rotating *packing nut*.
16. Attach no.29 to no.20,21 and place no.33 in the appropriate no.29. Place no.32 into no.33 and no.29, then tighten.

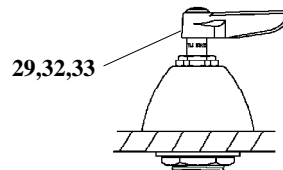

17. Connect supply lines, turn on water and check for leaks.

Note: It may become necessary to tighten bonnets and packing nuts to stop leakage from outlet or around spindle assembly.

Instrucciones Generales

Instalación:

Canillas/Unidad De Centro Y De Lados

1. Cierre la fuente de agua y desagüe las tuberías. Perfore (3) tres huecos en el lavatorio o en el mostrador donde la parte No.1 será instalada. Mire la ilustración abajo.

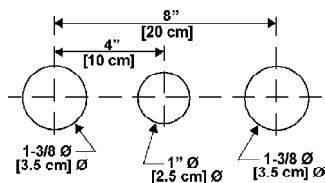

2. Sosteniendo la parte No.4 con una llave, remuévala la parte No.9/11 de la parte No.2, luego destornille la parte No.9/11. Remuévala las partes No.7 y 8 de la parte No.9/11 (La parte No.3 ya debe de estar apretada entre la parte No.2).

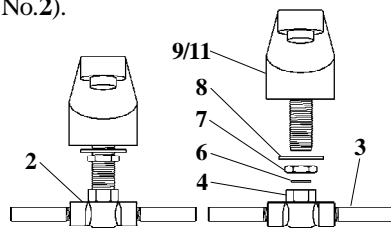

Valvulas De Los Lados

Caliente Y Frío

3. Remuévala las partes No.20/21, 19 y 18 de la parte No.15. (Las partes No.17 y 16 permanecen en la parte No.15.)

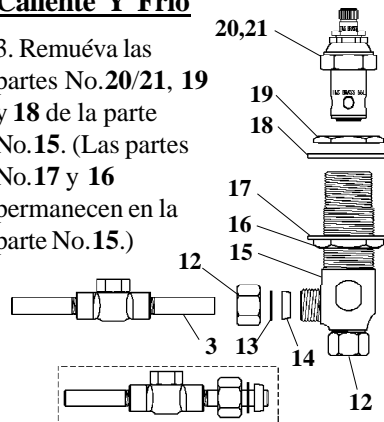

4. Remuévala las partes No.12, 13 y No.14 de la parte No.15. Ensamble los articulos anteriores en el brazo de la parte No.3 como esta demostrado en la ilustración (abajo -izquierda).

Ambos lados.

5. Inserte la parte No.3 entre la parte No.15, aprete a mano flojamente la parte No.12 en las roscas.

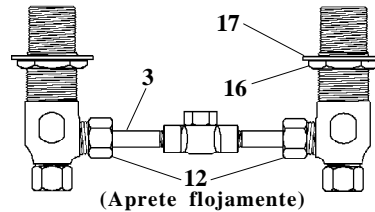

6. Coloque la parte No.15 ensamblada entre los huecos por debajo del lavatorio. Flojamente ensamble las partes No.16 y No.17 debajo del lavatorio. Coloque de nuevo las partes No.18 y No.19 en la parte No.15 sobre el lavatorio. Aprete a mano flojamente.

Haga esto para ambos lados.

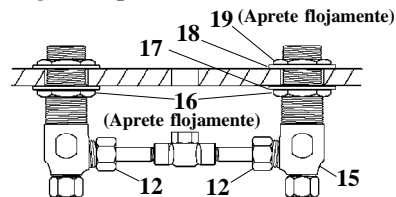

7. Coloque la parte No.9/11 a través del hueco en el lavatorio y coloque de nuevo las partes No.7 y No.8 en la parte No.9/11 por debajo del lavatorio. Ajusta las partes No.16 y No.19 para permitir la posición apropiada de la parte No.9/11.

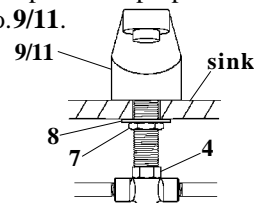

Instrucciones Generales

8. Junte de nuevo la parte No.9/11 a la parte No.4, asegurándose que la parte No.6 este situada.

9. Con una llave aprete la parte No.7 contra el fondo del lavatorio.

10. Aprete la parte No.16 en ambos lados de la parte No.15 con una llave por debajo del lavatorio. También aprete la parte No.12 al ensamble de la parte No.15.

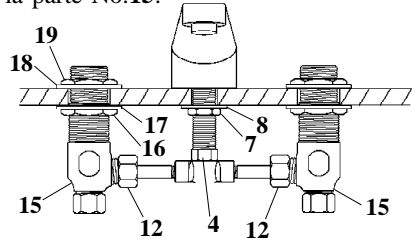

Nota: Cuando este apretando las partes No.7 y No.16, asegurese que ambas partes No.15 esten localizadas a la misma altura a nivel sobre el lavatorio. Antes de apretar las partes No.19 aprete las partes No.7 y No.16.

Ensamble De Válvula

11. Coloque de nuevo las partes No.20 y No.21 en ambos lados en la parte No.15 y aprete las cubiertas suficientemente para acentar las válvulas.

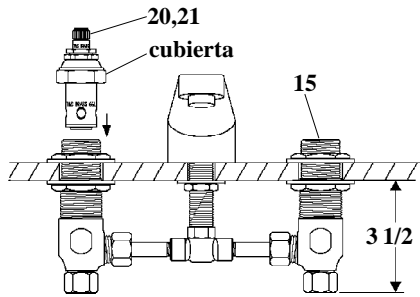

12. Remueva la tuerca de empaque y la contratuerca de ambos lados de las partes No.20 y No.21.

13. Deslice la parte No.22 sobre cada parte No.20 y No.21.

14. La tuerca de empaque y la contratuerca deben ser flojamente ensambladas antes de estar colocadas de nuevo en las partes No.20 y No.21. Aprete a mano solamente la contratuerca contra la parte No.22. **No use llave.**

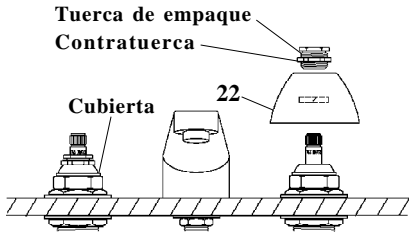

15. Aprete la tuerca de empaque contra la contratuerca usando llaves. Sostenga la contratuerca mientras que gira la tuerca de empaque.

16. Junte la parte No.29 a las partes No.20 y No.21 y coloque la parte No.33 en la apropiada No.29. Coloque la parte No.32 entre la parte No.33 y No.29 luego aprete.

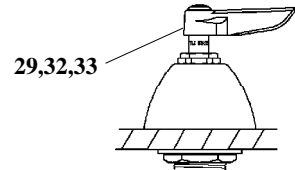

17. Conecte las líneas de surtido, abra la fuente de agua e inspeccione por filtraciones.

Nota: Puede llegar a ser necesario apretar las cubiertas y las tuercas de empaque para parar filtración de la boquilla o alrededor del ensamble del eje.

Instructions Générales

L'Installation: Le centre et le côté: Le robinet

1. Fermer la réserve de l'eau et égoutter la tuyauterie. Percer (3) trous dans l'évier ou le comptoir où vous aller installer N°.1. Voir le diagramme ci-dessous.

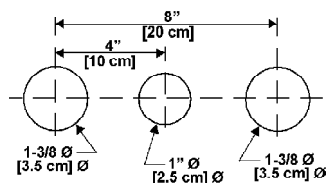

2. Enlever N°.9/11 de N°.2 en tenant N°.4 avec une clef anglaise, puis tourner N°.9/11. Enlever N°.7 et N°.8 de N°.9/11. (N°.3 devoir être bien fermer dans N°.2).

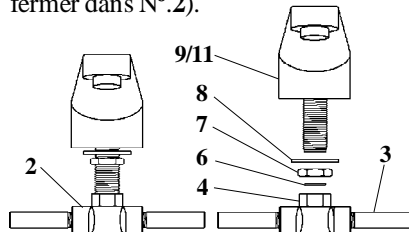

La Soupape Côté Chaude et Froide

3. Enlever N°.20/21, N°.19 et N°.18 de N°.15. (N°.17 et N°.16 rester sur N°.15.)

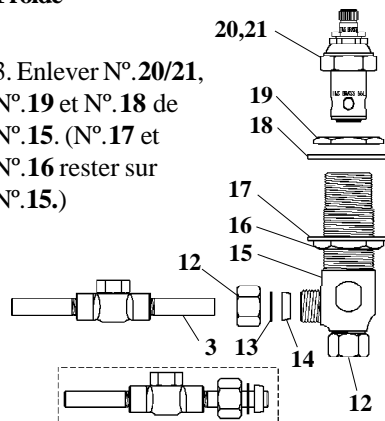

4. Enlever N°.12, N°.13 et N°.14 de N°.15. Assembler les choses précédentes sur le bras de N°.3, comme indiqué (ci-dessous à gauche) chaque côté.

5. Insérer N°.3 sur N°.15, resserrer sans bien serrer N°.12 sur les filets par le main.

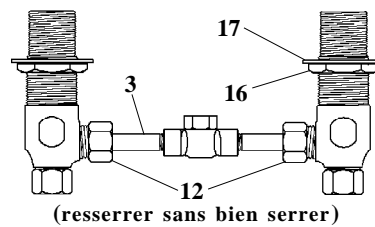

6. Mettre l'assemblage N°.15 dans les trous du fond de l'évier. Assembler, approximativement N°.16 et N°.17 au-dessous-de l'évier. Remplacer N°.18 et N°.19 sur N°.15 en haut de l'évier. Resserrer par le main - sans bien serrer. Faire la même chose pour chaque côté.

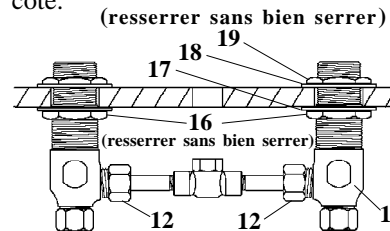

7. Mettre N°.9/11 à travers le trou dans l'évier et remplacer N°.7 et N°.8 sur N°.9/11 du fond de l'évier. Régler N°.16 et N°.19 pour permettre N°.9/11 d'être à sa place.

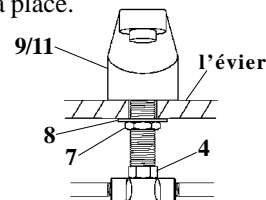

Instructions Générales

8. Réattacher N°.9/11 à N°.4. Soyez certain que N°.6 être à sa place.
9. Resserrer N°.7 avec une clef contre le fond de l'évier.
10. Resserrer le N°.16 du bas sur chaque côté de N°.15 sur le fond de l'évier avec une clef anglaise. Aussi resserrer N°.12 sur l'assemblage de N°.15.

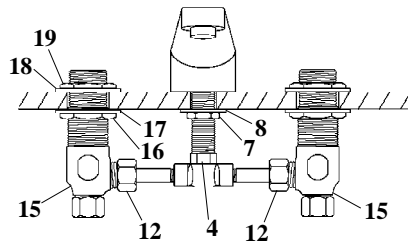

Noter: En resserrant N°.7 et N°.16, soyez certain que les N°.15's, tous les deux se situent au même niveau au-dessus-de l'évier. Resserrer N°.7 et N°.16 avant vous resserrer les N°.19's.

L'Assemblage de la Soupape

11. Remplacer N°.20 et N°.21 sur chaque côté de N°.15 et resserrer les capots pour vous permettre placer la soupape.

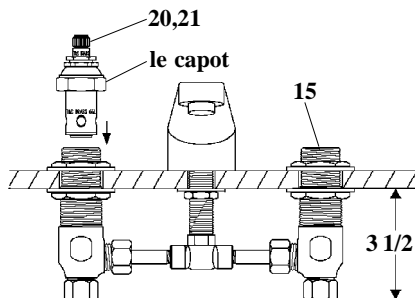

12. Enlever l'assemblage de l'écrou d'emballage/ le contre-écrou de N°.20,21 tous les deux.
13. Mettre N°.22 sur chaque N°.20,21.
14. L'écrou d'emballage et le contre-écrou doivent être assemblés approximativement avant de les remplacer dans N°.20,21. Resserrer par le main les contre-écrous seulement contre N°.22. N'utiliser pas une clef.

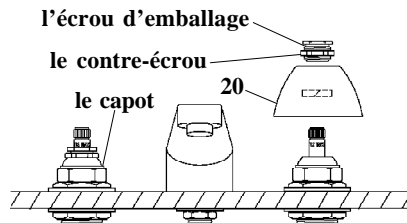

15. Resserrer l'écrou d'emballage contre le contre-écrou en utilisant deux clefs anglaises. Tenir le contre-écrou en tournant l'écrou d'emballage.
16. Attacher N°.29 à N°.20,21 et mettre N°.33 dans le N°.29 approprié. Mettre N°.32 dans N°.33 et N°.29 puis resserrer.

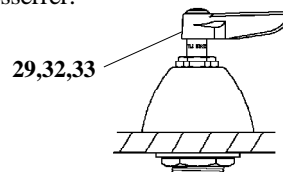

17. Brancher les tuyaux qui fournissent l'eau, recommencer l'eau et vérifier s'il y a des fuites.

Noter: Peut-être il faut resserrer les capots et les écrous d'emballage pour arrêter la fuite de la sortie de l'assemblage de la broche.

Allgemeine Anleitungen

Installation:

Armaturrumpf und Seitenarmaturen/ Wasserhähne zentrieren.

1. Wasserzufuhr absperren und Wasserleitungen entleeren. 3 (drei) Löcher in den Spültisch oder die Abdeckplatte bohren, in die Nr. 1 installiert wird. Siehe Abbildung unten:

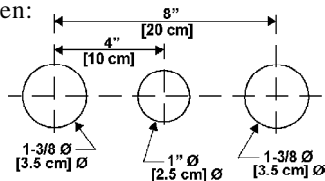

2. Nr. 9/11 von Nr. 2 entfernen, indem Nr. 4 mit einem Schraubenschlüssel festgehalten wird, dann Nr. 9/11 drehen. Nr. 7 und Nr. 8 von Nr. 9/11 entfernen. (Nr. 3 sollte bereits in Nr. 2 festsitzen).

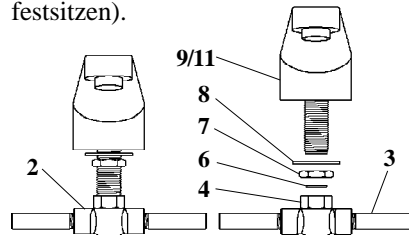

Warm- und Kaltwasserseitenventile

3. Nr. 20/21, 19 und 18 von Nr. 15 entfernen. (Nr. 17 und 16 bleiben auf Nr. 15).

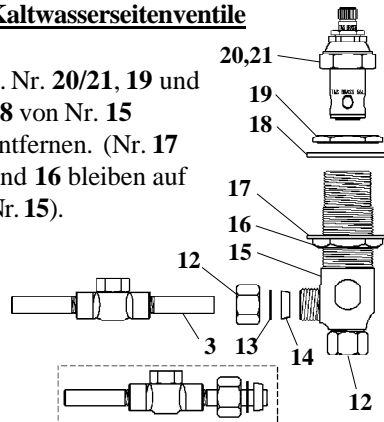

4. Nr. 12, 13 und 14 von Nr. 15 entfernen. Auf beiden Seiten die vorhergehenden Teile auf dem Arm von Nr. 3 aufreihen, wie in der Abbildung (unten links) gezeigt wird.

5. Nr. 3 lose in Nr. 15 einfügen, Nr. 12 lose mit der Hand auf dem Gewinde festdrehen.

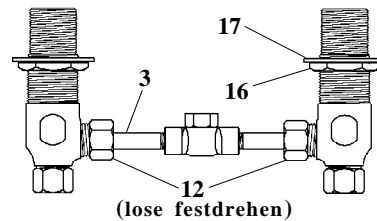

6. Die Garnitur Nr. 15 von der Unterseite des Spültisches in die Löcher einführen. Nr. 16 und 17 lose unter dem Spültisch zusammensetzen.

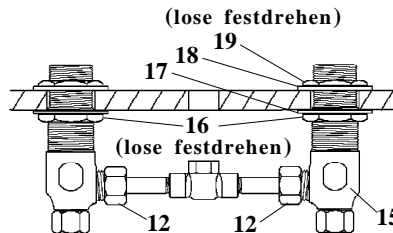

7. Nr. 9/11 durch das Loch in dem Spültisch führen und Nr. 7 und 8 wieder von der Unterseite des Spültisches auf Nr. 9/11 aufsetzen. Nr. 16 und 19 justieren, um die ordnungsgemäße Positionierung von Nr. 9/11 zu ermöglichen.

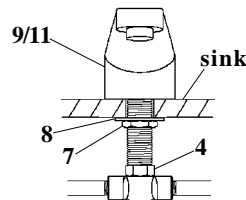

Allgemeine Anleitungen

8. Nr. 9/11 wieder mit Nr. 4 verbinden. Sicherstellen, daß sich Nr. 6 am richtigen Platz befindet.

9. Nr. 7 mit einem Schraubenschlüssel gegen die Unterseite des Spültisches festziehen.

10. Unterseite von Nr. 16 auf beiden Seiten von Nr. 15 auf der Unterseite des Spültisches mit einem Schraubenschlüssel festziehen. Nr.12 auf der Garnitur Nr.15 festziehen.

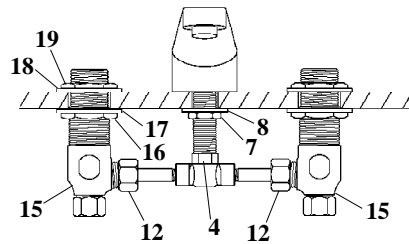

Anmerkung: Beim Festziehen von Nr. 7 und Nr. 16 sicherstellen, daß beide Nr. 15 sich auf der Oberseite des Spültisches in gleicher Höhe befinden. Nr. 7 und 16 festziehen, bevor Nr. 19 festgezogen wird.

Ventilmontage

11. Nr. 20 und Nr. 21 auf beide Seiten von Nr. 15 aufsetzen und die Hauben genügend anziehen, um das Ventil einzusetzen.

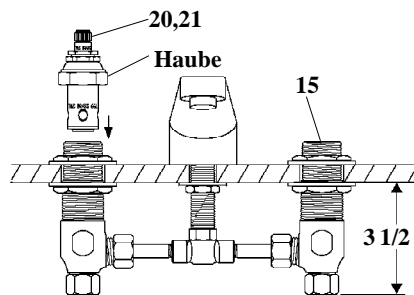

12. Dichtungsmutter/Gegenmutter-Garnitur von beiden Nr. 20/21 entfernen.

13. Nr. 22 über beide Nr. 20/21 schieben.

14. Dichtungsmutter und Gegenmutter sollten lose zusammengesetzt werden, bevor sie wieder in Nr. 20/21 eingesetzt werden. Dichtungsmuttern mit der Hand nur gegen Nr. 22 anziehen. *Keinen Schraubenschlüssel benutzen.*

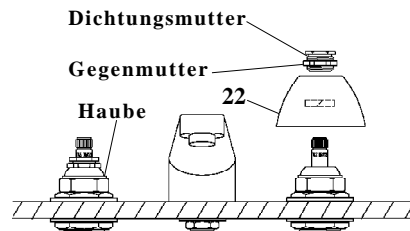

15. Dichtungsmutter gegen die Gegenmutter unter Verwendung von zwei Schraubenschlüsseln festziehen. Gegenmutter festhalten, während die Dichtungsmutter gedreht wird.

16. Nr. 29 mit Nr. 20, 21 verbinden und Nr. 33 in die zutreffende Nr. 29 einsetzen. Nr. 32 in Nr. 33 und 29 einsetzen, dann festdrehen.

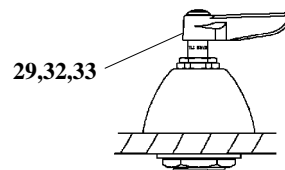

17. Wasserzufuhr herstellen, Wasserventil öffnen und auf Dichtigkeit prüfen.

Anmerkung: Es kann notwendig sein, daß die Hauben und Dichtungsmuttern festgezogen werden müssen, um Leckstellen vom Auslauf oder um die Spindelgarnitur zu unterbinden

RELATED T&S BRASS PRODUCT LINE



B-0868-04
Medical Lavatory Faucet
with Pop-Up Waste

T&S BRASS AND BRONZE WORKS, INC.

A firm commitment to application-engineered plumbing products

2 Saddleback Cove, P.O. Box 1088,
Travelers Rest, SC 29690

Phone: (864) 834-4102

Fax: (864) 834-3518

E-mail: tsbrass@tsbrass.com

T & S Brass-Europe

'De Veenhoeve'

Oude Nieuwveenseweg 84

2441 CW Nieuwveen

The Netherlands



RELIABILITY BUILT IN™