



Limited Five (5) Year Warranty

T&S warrants to the original purchaser (other than for purposes of resale) that such product is free from defects in material and workmanship for a period of five (5) years from the date of purchase. During this one-year warranty period, if the product is found to be defective, T&S shall, at its options, repair and/or replace it. To obtain warranty service, products must be returned to...

T&S Brass and Bronze Works, Inc.
Attn: Warranty Repair Department
2 Saddleback Cove
Travelers Rest, SC 29690

Shipping, freight, insurance, and other transportation charges of the product to T&S and the return of repaired or replaced product to the purchaser are the responsibility of the purchaser. Repair and/or replacement shall be made within a reasonable time after receipt by T&S of the returned product. This warranty does not cover items which have received secondary finishing or have been altered or modified after purchase, or for defects caused by physical abuse to or misuse of the product, or shipment of the products.

Any express warranty not provided herein, and any remedy for Breach of Contract which might arise, is hereby excluded and disclaimed. Any implied warranties of merchantability or fitness for a particular purpose are limited to one year in duration. Under no circumstances shall T&S be liable for loss of use or any special consequential costs, expenses or damages.

Some states do not allow limitations on how long and implied warranty lasts or the exclusion or limitation of incidental or consequential damages, so the above limitations or exclusions may not apply to you. Specific rights under this warranty and other rights vary from state to state.

P/N: 098-010964-45 Rev.1
Date: 981203
Drawn: CW
Checked: MAB 4/5/99
Approved: MW 4/6/99

Installation and Maintenance Instructions



Water and Steam Appliance Connectors

Deutsch: Installations- und
Wartungsanleitungen

Español: la Instalación y las
Instrucciones de
Mantenimiento

Français: les Instructions
d'Installation et
d'Entretien

Exploded View

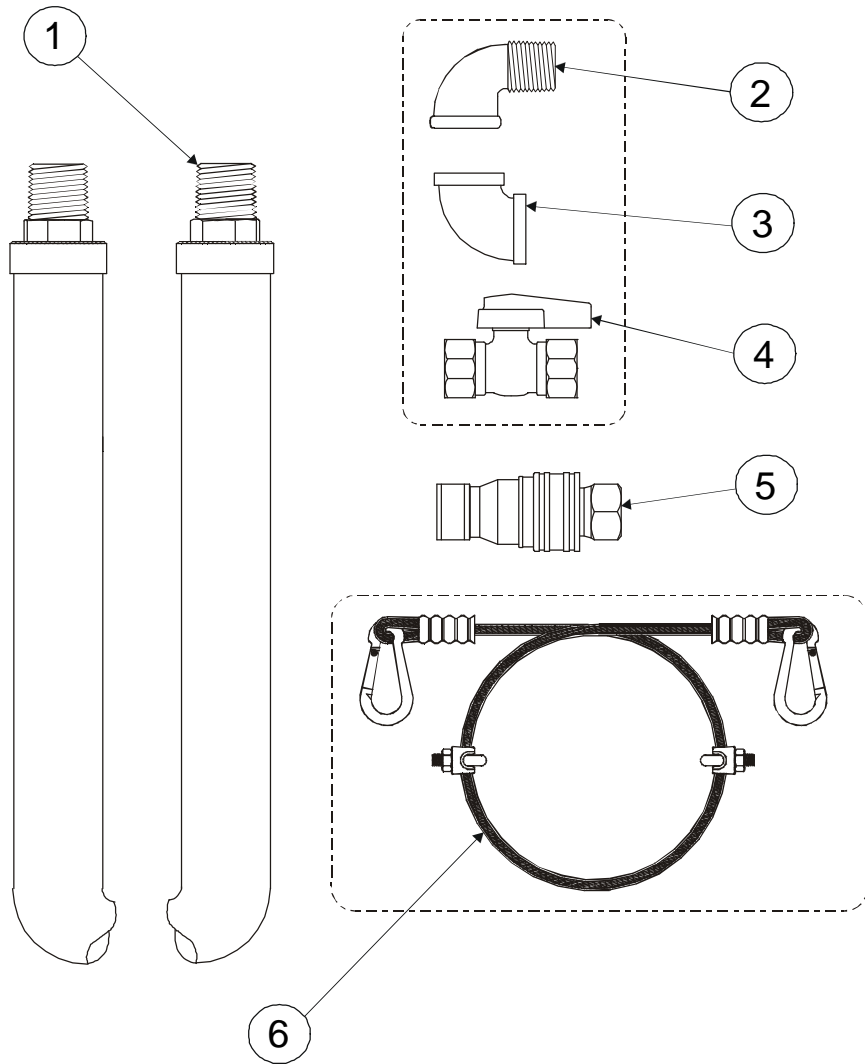

Some items are listed for instructional purposes and may not be sold as separate parts.

Part Number Guide

Safe-T-Link Fittings and Accessories

1	Asm, Hose Coated - Water	HW
	Asm, Hose Coated - Steam	HS
2	90° Street Elbow, Male/Female	*
3	90° Elbow, Female/Female	*
4	Shut-Off Valve	*
5	Asm, Quick Disconnect - Water	AW
	Asm, Quick Disconnect - Steam	AS
6	Asm, Kit - Restraining Cable	**

* These accessories must be supplied by installer, if necessary.

** This accessory should be purchased separately by installer, if necessary

Specifications

Water Appliance Connectors		Steam Appliance Connectors																													
HW -		HS -																													
<table border="1"> <thead> <tr> <th>Hose Design</th> <th>Order</th> </tr> </thead> <tbody> <tr> <td>Male to Male</td> <td>2</td> </tr> <tr> <td>Male To Quick Disconnect</td> <td>4</td> </tr> </tbody> </table>		Hose Design	Order	Male to Male	2	Male To Quick Disconnect	4	<table border="1"> <thead> <tr> <th>Hose Design</th> <th>Order</th> </tr> </thead> <tbody> <tr> <td>Male to Male</td> <td>2</td> </tr> <tr> <td>Male To Quick Disconnect</td> <td>4</td> </tr> </tbody> </table>		Hose Design	Order	Male to Male	2	Male To Quick Disconnect	4																
Hose Design	Order																														
Male to Male	2																														
Male To Quick Disconnect	4																														
Hose Design	Order																														
Male to Male	2																														
Male To Quick Disconnect	4																														
<table border="1"> <thead> <tr> <th colspan="2">Thread and Diameter</th> </tr> </thead> <tbody> <tr> <td>1/4"</td> <td>A</td> </tr> <tr> <td>3/8"</td> <td>B</td> </tr> <tr> <td>1/2"</td> <td>C</td> </tr> <tr> <td>3/4"</td> <td>D</td> </tr> <tr> <td>1"</td> <td>E</td> </tr> <tr> <td>1-1/4"</td> <td>F</td> </tr> </tbody> </table>		Thread and Diameter		1/4"	A	3/8"	B	1/2"	C	3/4"	D	1"	E	1-1/4"	F	<table border="1"> <thead> <tr> <th colspan="2">Thread and Diameter</th> </tr> </thead> <tbody> <tr> <td>1/4"</td> <td>A</td> </tr> <tr> <td>3/8"</td> <td>B</td> </tr> <tr> <td>1/2"</td> <td>C</td> </tr> <tr> <td>3/4"</td> <td>D</td> </tr> <tr> <td>1"</td> <td>E</td> </tr> <tr> <td>1-1/4"</td> <td>F</td> </tr> </tbody> </table>		Thread and Diameter		1/4"	A	3/8"	B	1/2"	C	3/4"	D	1"	E	1-1/4"	F
Thread and Diameter																															
1/4"	A																														
3/8"	B																														
1/2"	C																														
3/4"	D																														
1"	E																														
1-1/4"	F																														
Thread and Diameter																															
1/4"	A																														
3/8"	B																														
1/2"	C																														
3/4"	D																														
1"	E																														
1-1/4"	F																														
<table border="1"> <thead> <tr> <th colspan="2">Length</th> </tr> </thead> <tbody> <tr> <td>12"</td> <td>12</td> </tr> <tr> <td>24"</td> <td>24</td> </tr> <tr> <td>36"</td> <td>36</td> </tr> <tr> <td>48"</td> <td>48</td> </tr> <tr> <td>60"</td> <td>60</td> </tr> <tr> <td>72"</td> <td>72</td> </tr> </tbody> </table>		Length		12"	12	24"	24	36"	36	48"	48	60"	60	72"	72	<table border="1"> <thead> <tr> <th colspan="2">Length</th> </tr> </thead> <tbody> <tr> <td>12"</td> <td>12</td> </tr> <tr> <td>24"</td> <td>24</td> </tr> <tr> <td>36"</td> <td>36</td> </tr> <tr> <td>48"</td> <td>48</td> </tr> <tr> <td>60"</td> <td>60</td> </tr> <tr> <td>72"</td> <td>72</td> </tr> </tbody> </table>		Length		12"	12	24"	24	36"	36	48"	48	60"	60	72"	72
Length																															
12"	12																														
24"	24																														
36"	36																														
48"	48																														
60"	60																														
72"	72																														
Length																															
12"	12																														
24"	24																														
36"	36																														
48"	48																														
60"	60																														
72"	72																														
<table border="1"> <thead> <tr> <th colspan="2">Quick Disconnect</th> </tr> </thead> <tbody> <tr> <td>AW-5A</td> <td>1/4"</td> </tr> <tr> <td>AW-5B</td> <td>3/8"</td> </tr> <tr> <td>AW-5C</td> <td>1/2"</td> </tr> <tr> <td>AW-5D</td> <td>3/4"</td> </tr> <tr> <td>AW-5E</td> <td>1"</td> </tr> <tr> <td>AW-5F</td> <td>1-1/4"</td> </tr> </tbody> </table>		Quick Disconnect		AW-5A	1/4"	AW-5B	3/8"	AW-5C	1/2"	AW-5D	3/4"	AW-5E	1"	AW-5F	1-1/4"	<table border="1"> <thead> <tr> <th colspan="2">Quick Disconnect</th> </tr> </thead> <tbody> <tr> <td>AS-5A</td> <td>1/4"</td> </tr> <tr> <td>AS-5B</td> <td>3/8"</td> </tr> <tr> <td>AS-5C</td> <td>1/2"</td> </tr> <tr> <td>AS-5D</td> <td>3/4"</td> </tr> <tr> <td>AS-5E</td> <td>1"</td> </tr> <tr> <td>AS-5F</td> <td>1-1/4"</td> </tr> </tbody> </table>		Quick Disconnect		AS-5A	1/4"	AS-5B	3/8"	AS-5C	1/2"	AS-5D	3/4"	AS-5E	1"	AS-5F	1-1/4"
Quick Disconnect																															
AW-5A	1/4"																														
AW-5B	3/8"																														
AW-5C	1/2"																														
AW-5D	3/4"																														
AW-5E	1"																														
AW-5F	1-1/4"																														
Quick Disconnect																															
AS-5A	1/4"																														
AS-5B	3/8"																														
AS-5C	1/2"																														
AS-5D	3/4"																														
AS-5E	1"																														
AS-5F	1-1/4"																														

General Instructions

Important Safety Instructions:

WARNING: Please read all instructions carefully. Failure to fully read instructions and follow them could result in severe injury or death.

1. Water or Steam connectors and accessories should be installed in **strict accordance** with applicable federal, state and local installation codes.
2. As with any other fluid transmission line or device, it is recommended that **installation and testing be done by qualified personnel**.
3. **An accessible manual no.4 should be installed** at the outlet of the supply piping system upstream of the connector. Each piece of equipment should have its own no.4.
4. **No.5 coupling is not to be used as the primary shut-off.**
5. **A restraining device is recommended** for all types of moveable appliances. The **T&S Sure-Link Restraining Cable** (no.6) is the recommended restraining device for castered appliances.
6. With these Water and Steam connectors, **AVOID:**
 - Flexing, stretching, excessive bending, and vibration.
 - Movement after installation on fixed appliances.
 - Movement on moveable appliance (those with factory equipped casters) except for repair, maintenance, or cleaning.

7. **Final assembly must be tested for leaks.**

Instructions: Safe-T-Link Water and Steam Connectors

General

1. Carefully read these entire Installation Instructions prior to start of work.
2. Shut the manual no.4 on supply line to "OFF". If there is no no.4, main supply line should be turned off.
3. To be able to position appliance as close to the wall as possible, the two ends of the Safe-T-Link connector should be offset from each other.

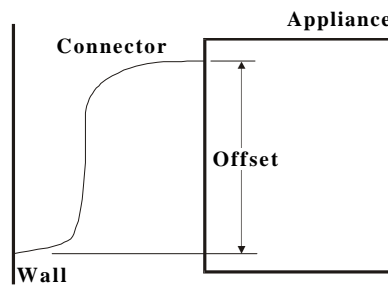

4. Each appliance should have its own approved manual no.4 from the main supply line.

Supply Side

1. If supply side Tee is already male, apply Teflon Tape or sealant to male threads at supply side. Thread no.4 onto male threads and tighten.

Continued on next page...

General Instructions

2. If supply side Tee is female, apply Teflon Tape or sealant to threads of a pipe Nipple (*not supplied*), and thread Nipple into female pipe Tee. Then, thread onto exposed thread of Nipple, no.4, and tighten.

3. Apply thread Teflon Tape or sealant to male thread of no.1 Connector. Thread male no.1 Connector into no.4 and tighten.

Appliance Side

(Without Quick Disconnect - no.5)

1. Apply Teflon Tape or sealant to Appliance's male Stub and thread no.3 (Female to Female) to male Stub.

2. Apply Teflon Tape or sealant to male thread of no.1 connector. Thread no.1 connector into no.3 (Female to Female) at appliance and tighten.

Appliance Side

(With Quick Disconnect)

1. Apply Teflon Tape or sealant to Appliance's male Stub and thread no.2 (Male to Female) to male Stub.

2. Separate no.5 Nipple half from Coupling half. Apply Teflon Tape or sealant to male threads on no.2 (Male/Female).

3. Thread Nipple half of no.5 onto no.2 (Male/Female) at appliance and tighten.

4. Reconnect no.5 halves.

WARNING: No.5 must be oriented so fluid enters Coupling half and exits Nipple half. Follow flow direction arrows marked below and no.5 itself.

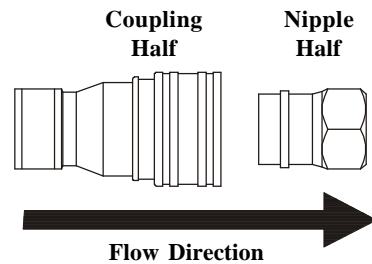

Finishing and Testing

1. Check tightness of all connections and perform leak test.

2. After installation of no.1 Connector, carefully push appliance back to operation position and check that no.1 connector is not kinked, overbent, or caught under appliance casters.

3. If no.6 will be used, install device and set length so no.1 connector is never fully extended.

Instrucciones Generales

2. Si las roscas de la unión en “t” en el extremo del surtidor son femeninas, aplique cinta de Teflon o sellador a las roscas del tubo (*no esta surtido*), y enrosque el tubo dentro de la unión femenina en T. Luego, enrosque en la rosca exhibida del tubo, la parte No.4 y apriete.

3. Aplique cinta de Teflon o sellador a la rosca masculina del Conector parte No.1. Enrosque el Conector masculino parte No.1 dentro de la parte No.4 y apriete.

Extremo Del Instrumento (sin desconectado rapido-No.5)

1. Aplique cinta de Teflon o sellador al cabo masculino del instrumento y enrosque la parte No.3 (Femenina a Femenina) al cabo masculino.

2. Aplique cinta de Teflon o sellador a la rosca masculina del conector parte No.1. Enrosque el conector parte No.1 dentro de la parte No.3 (Femenina a Femenina) en el instrumento y apriete.

Extremo Del Instrumento (Con Desconectado Rápido)

1. Aplique cinta de Teflon o sellador al cabo masculino del instrumento y enrosque la parte No.2 (Masculino a Femenina) al cabo masculino.

2. Separe la parte No.5 la mitad del enchufe y la mitad del encaje. Aplique cinta de Teflon o sellador a las roscas masculinas en la parte No.2 (Masculino/Femenino).

3. Enrosque la parte media de la enchufe de la parte No.5 en la parte

No.2 (Masculino/Femenino) en el instrumento y apriete.

4. Conecte de nuevo las dos mitades.

AVISO: La parte No.5 tiene que ser orientada de modo que el fluido entre por la mitad del encaje y salga por la mitad de la enchufe. Siga la flecha en la dirección de la corriente como están indicadas abajo y en la propia parte No.5.

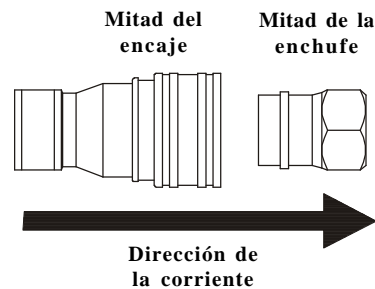

Terminando y Ensayando

1. Inspeccione todas las conexiones que estén apretadas y conduzca ensayos para detectar filtración.
2. Después de instalar el conector parte No.1, cuidadosamente empuje el aparato a su posición operativa e inspeccione que el conector parte No.1 no este enroscado, sobre doblado o pisado bajo las ruedas del aparato.
3. Si la parte No.6 no será usada, instale el aparato y componga el largo de modo que el conector parte No.1 nunca sea totalmente extendido.

Instructions Générales

Les Instructions De La Sécurité Importantes:

Avertissement: Prier lire tous les instructions prudemment. Si vous ne les lire pas et si vous ne les suivre pas complètement vous pouvoir devenir blessé ou vous pouvoir mourir.

1. Les branchements et les accessoires de l'eau ou de la vapeur devoir être installer conformément à tous les codes de l'installation de votre administration municipale.
2. Comme avec n'importe quelle autre ligne ou dispositif liquide de transmission, on vous recommander que **l'installation et le test être faire par le personnel qualifié.**
3. **Un N°.4 manuel et accessible devoir être installer** à la sortie du système sifflant d'approvisionnement d'amont du connecteur. Chaque morceau de matériel devoir avoir son propre numéro 4.
4. **On ne pouvoir pas utiliser le couplage N°.5 comme l'interruption primaire.**
5. Nous vous conseiller à utiliser un dispositif de retenir avec tous les appareils mobiles. Nous vous conseiller à utiliser **le câble de retenir "T & S Sure Link"** (N°.6) pour les appareils avec les roulettes.
6. Avec les branchements de l'eau et de la vapeur:
 - Ne les plier pas, Ne les fléchir pas, Ne les tendre pas et éviter les vibrations.
 - Éviter les mouvements après l'installation sur les appareils fixés.

- Éviter les mouvements sur les appareils mobiles(ceux qui avoir les roulettes appliqué à l'usine) sauf que pour les réparations, l'entretien ou le nettoyage.

7. Vous devoir vérifier l'assemblage pour les fuites.

Les Instructions "Safe-T-Link" Les Branchements De L'eau Et De La Vapeur

1. Vous devoir lire tous les instructions d'installation entier avant vous commencer le travail.
2. Fermer le N°.4 manuel sur la ligne d'alimentation à la marque "off" (fermé). S'il n'y a pas un N°.4 la ligne d'alimentation primaire devoir être fermer.
3. Pour placer l'appareil près du mur que possible, les deux extrémités du branchement "Safe-T-Link" devoir être placer opposé.

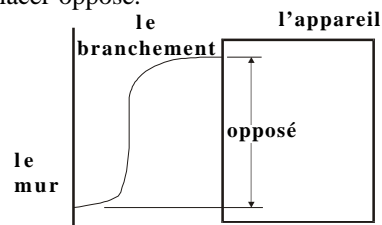

4. Chaque appareil devoir avoir son propre N°.4 manuel approuvé de la ligne d'alimentation.

Le Côté D'Alimentation

1. Si le côté d'alimentation être déjà masculin, appliquer le ruban en Téflon ou l'enduit étanche aux filets masculins au côté d'alimentation. Mettre N°.4 sur les filets masculins et resserrer.

continuer à la page suivant...

Instructions Générales

2. Si le côté d'alimentation être féminin, appliquer le ruban en Téflon ou l'enduit étanche aux filets du raccord du tuyau (pas fournir) et mettre le raccord à travers le "T" féminin. Puis mettre aux filets exposés du raccord, N°.4, et resserrer.

3. Appliquer le ruban en Téflon ou l'enduit étanche aux filets masculins du branchement N°.1. Mettre le branchement N°.1 dans N°.4 et resserrer.

Le Côté D'Appareil (Sans le débranchement vite-N°.5)

1. Appliquer le ruban en Téflon ou l'enduit étanche au morceau masculin d'appareil et mettre N°.3 (femelle à femelle) au morceau masculin.

2. Appliquer le ruban en Téflon ou l'enduit étanche aux filets masculins du branchement N°.1. Mettre le branchement N°.1 dans N°.3 (femelle à femelle) à l'appareil et resserrer.

Le Côté D'Appareil (Avec le débranchement vite)

1. Appliquer le ruban en Téflon ou l'enduit étanche au morceau masculin d'appareil et mettre N°.3 (mâle à femelle) au morceau masculin.

2. Séparer la moitié du raccord N°.5 de la moitié de l'attelage. Appliquer le ruban en Téflon ou l'enduit étanche aux filets masculins de N°.2 (mâle/ femelle).

3. Mettre la moitié du raccord N°.5 sur N°.2 de la moitié (mâle/ femelle) à l'appareil et resserrer.

4. Brancher encore les deux moitiés .

Avertissement: N°.5 devoir s'orienter pour permettre l'entrée du fluide à la moitié d'attelage et sortir la moitié du raccord. Suivre les flèches de la direction de la circulation indiqué au-dessous et sur soi-même.

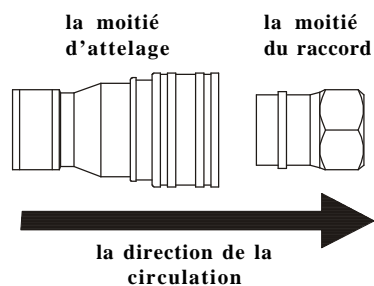

La Fin Et L'Épreuve

1. Vérifier les branchements et vérifier s'il y a des fuites.

2. Après l'installation du branchement pousser prudemment l'appareil à sa position originale et vérifier que la ligne du branchement N°.1 n'entre pas trop plier ni au-dessous- des roulettes de l'appareil.

3. Si vous aller utiliser N°.6, installer le dispositif et régler la longueur pour permettre l'exstension du branchement N°.1.

Allgemeine Anleitungen

Wichtige Sicherheitsanweisungen:

WARNUNG: Bitte alle Anweisungen sorgfältig durchlesen. Das Unterlassen, die Anweisungen vollständig durchzulesen und sie zu befolgen, kann zu schweren Verletzungen oder zum Tod führen.

1. Wasser- oder Dampfleitungsanschlussteile und Zubehör müssen unter strenger Einhaltung aller zur Anwendung kommenden Vorschriften installiert werden.
2. Wie bei jeder anderen Flüssigkeitsübertragungsleitung oder jedem anderen Flüssigkeitsübertragungsgerät wird empfohlen, daß die **Installation und die Überprüfung durch fachmännisch geschultes Personal erfolgt.**
3. **Eine zugängliche Handschaltung Nr. 4 sollte** an dem Auslauf des Versorgungssystemsystems oberhalb des Anschlusses **installiert werden.** Jedes Geräteteil sollte seine eigene Handschaltung Nr. 4 haben.
4. **Die Kupplung Nr. 5 ist nicht als primäre Abschaltung zu verwenden.**
5. Für alle Arten von beweglichen Geräten wird ein Blockiergerät empfohlen. Das **T&S Sure-Link** Blockierkabel (Nr. 6) ist das empfohlene Blockiergerät für Geräte auf Rollen.
6. Im Zusammenhang mit Wasser- und Dampfanschlußteilen folgendes **VERMEIDEN:**
 - Biegen, strecken, übermäßiges biegen und erschüttern.

- Bewegung nach der Installation auf feststehenden Geräten (solche mit von dem Hersteller installierten Rollen) ausgenommen bei Reparaturen, Wartung oder Reinigung

7. Zusammengesetzte Garnitur muß auf Dichtigkeit geprüft werden.

Anweisungen: Safe-T-Link-Wasser- und Dampfanschlußteile

Allgemeines

1. Vor Beginn der Arbeit alle diese Installationsanweisungen sorgfältig durchlesen.
2. Handschaltung Nr. 4 der Zuflußleitung auf "ZU" stellen. Falls es keine Handschaltung gibt, Hauptzuflußleitung abdrehen.
3. Um das Gerät so nahe wie möglich an die Wand zu stellen, sind die beiden Enden des **Safe-T-Link** Anschlußteils gegeneinander zu versetzen.

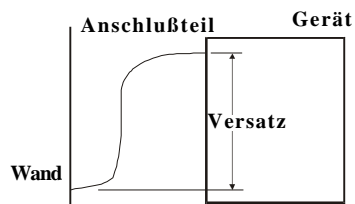

4. Jedes Gerät sollte eine eigene zugelassene Handschaltung Nr. 4 von der Hauptzuflußleitung haben.

Zuleitung

1. Falls das T-Stück der Zuleitung schon ein Außengewinde ist, Teflonband oder Dichtungsmittel auf das Außengewinde der Zufuhrseite auftragen. Nr. 4 durch das Außengewinde führen und festziehen.

Fortsetzung auf der nächsten Seite...

Allgemeine Anleitungen

2. Falls das T-Stück der Zuleitung Seite ein Innengewinde hat, Teflonband oder Dichtungsmittel auf das Gewinde eines Rohrstopfens (wird nicht mitgeliefert) der Zufuhrseite auftragen und Stopfen durch das Innengewinde des T-Rohrs führen. Dann durch das freiliegende Gewinde des Stopfens Nr. 4 führen und festziehen.

3. Gewindeteflonband oder Gewindedichtungsmittel auf das Außengewinde des Anschlußteils Nr. 1 auftragen. Außengewinde des Anschlußteils Nr. 1 in Nr. 4 einführen und festziehen.

Geräteseite (ohne Schnellabschaltung Nr. 5)

1. Teflonband oder Dichtungsmittel auf das Außenende des Geräts auftragen und Nr. 3 (Innengewinde zu Innengewinde) zu dem Außenende führen.

2. Teflonband oder Dichtungsmittel auf das Außengewinde des Anschlußteils Nr. 1 auftragen. Anschlußteil Nr. 1 in Nr. 3 (Innengewinde zu Innengewinde) des Geräts einführen und festziehen.

Geräteseite (mit Schnellabschaltung)

1. Teflonband oder Dichtungsmittel auf das Außenende des Geräts auftragen und Nr. 3 (Innengewinde zu Innengewinde) in Außenende einschrauben.

2. Nr. 5 Muffenhälfte von der Stopfenhälfte trennen. Teflonband oder Dichtungsmittel auf Außengewinde von Nr. 2 auftragen (Außengewinde/ Innengewinde).

3. Stopfenhälfte von Nr. 5 in Nr. 2 (Außen-/Innengewinde) des Geräts einschrauben und festziehen.

4. Die Nr. 5 Hälften wieder verbinden.

WARNUNG: Nr. 5 muß so ausgerichtet sein, daß die Flüssigkeit durch die Muffenhälfte einfließt und durch die Stopfenhälfte ausfließt. Flußrichtungspfeile unten und auf Nr. 5 beachten.

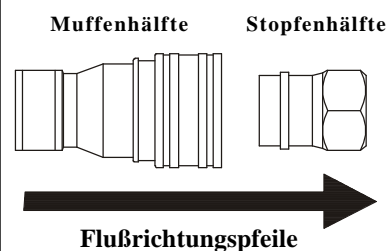

Abschluß und Überprüfung

1. Den festen Sitz aller Verbindungen prüfen und Dichtigkeitsprüfung durchführen.

2. Nach der Installation des Anschlußstücks Nr. 1 Gerät vorsichtig in die Betriebsstellung zurückschieben und sicherstellen, daß Anschlußstück Nr. 1 keine Knoten hat, nicht zu stark gebogen ist oder unter eine der Rollen des Geräts geraten ist.

3. Falls Nr. 6 benutzt wird, Vorrichtung installieren und die Länge so einstellen, daß Anschlußstück Nr. 1 nie voll ausgezogen ist.

RELATED T&S BRASS PRODUCT LINE



**G-6
Sure-Link
Restraining Cable**

T&S BRASS AND BRONZE WORKS, INC.

A firm commitment to application-engineered plumbing products

2 Saddleback Cove, P.O. Box 1088,
Travelers Rest, SC 29690

Phone: (864) 834-4102
Fax: (864) 834-3518

E-mail: tsbrass@tsbrass.com

T & S Brass-Europe
'De Veenhoeve'
Oude Nieuwveenseweg 84
2441 CW Nieuwveen
The Netherlands

