



Installation and Maintenance Instructions

Warranty

Because T&S Brass and Bronze Works, Inc. has no control over the shipment, installation or use of the restraining device or the installation kit, no warranty is made nor responsibility assumed by T&S Brass for incidental or consequential damage.

Attention California Residents:

"WARNING: This product contains chemicals known to the State of California to cause cancer, and birth defects or other reproductive harm."

T&S Brass and Bronze Works, Inc.
Attn: Warranty Repair Department
2 Saddleback Cove
Travelers Rest, SC 29690



Safe-T-Link Restraining Device

(For use with castered
appliances)

Deutsch: Installations- und
Wartungsanleitungen

Español: la Instalación y las
Instrucciones de Man-
tenimiento

Français: les Instructions
d'Installation et
d'Entretien

P/N: 098-010966-45 Rev.3
Date: 04-28-15
Drawn: TEH
Checked: GEF 07-27-15
Approved: JHB 07-31-15

Exploded View

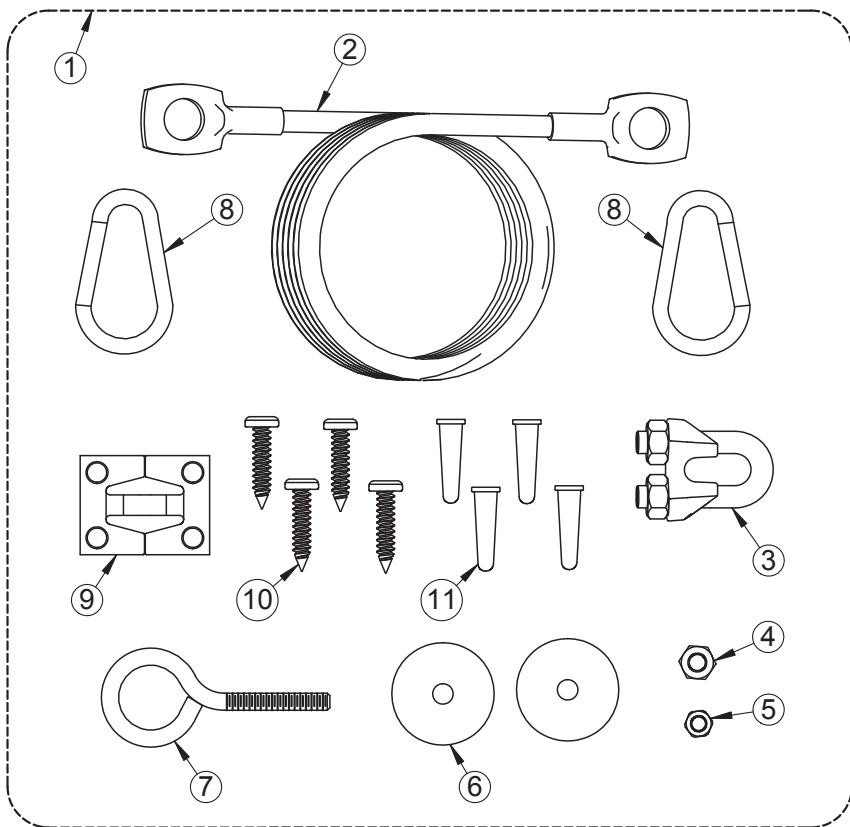

Part Number Guide

Safe-T-Link Restraining Device

1	Asm, Restraining Device, Complete Kit	AG-RC
2	Restraining Cable	N/A
3	Cable Clamp	N/A
4	Lock Nut, 1/4"	N/A
5	Hex Nut, 1/4"	N/A
6	Washer	N/A
7	Eye-Bolt	N/A
8	Snap Hooks	N/A
9	Wall Bracket	N/A
10	Screws, #12	N/A
11	Plastic Anchor	N/A

General Instructions

The purpose of this Restraining Device cable is to never allow the Gas Hose to be stretched to its full extent. Install this cable in-line, parallel with the Gas Connector. The Cable should be adjusted so that it is shorter than the Gas Connector.

WARNING: This Restraining Device must always be connected when the appliance is in service. Disconnect only when moving appliance when servicing or cleaning. Then reconnect restraint when appliance has been returned to its normal position.

Note: Restraining Device required according to the following standards, per ANSI:

Z21.69	Gas Connectors for Movable Gas Appliances
Z21.41	Quick-Disconnect Couplings
Z83.11	Commercial Gas Ranges
Z83.12	Commercial Gas Ovens
Z83.13	Commercial Gas Fryers
Z223.1	National Fuel Gas Code Section 5.5.1.e
CAN/CGA 6.16	Connectors for Movable Gas Appliances
CAN/CGA B.149.1	National Gas Installation Code (5.22.5)
B.149.2	Propane Installation Code (5.22.5)

Installations:

Wall Anchor

1. Locate stud or sturdy surface on wall where no.1 will be positioned, as closely as possible to appliance connector gas inlet and outlet connections. Then drill 1/4" hole through frame member of appliance.

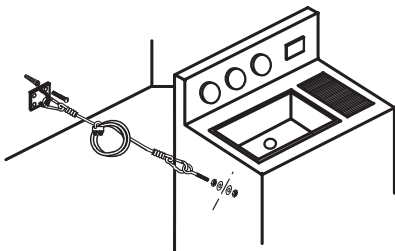

Note: Extreme caution should be used when drilling hole in appliance to insure no internal parts are damaged by drilling. Use the appliance manufacturer's recommendation.

2. Thread no.5 and slide no.6 onto no.7. Insert no.7 through drilled hole and secure inside appliance with other no.6 and no.4.

Cable Installation

Attach each no.8; (one) to no.9 and (the other) to no.7.

Cable Adjustment

Using no.3, adjust the no.2 extended length to prevent over bending or kinking appliance connector.

Finished installation, hose without SwiveLink:

Finished installation, hose with SwiveLink:

Hose should be slack, with no bends or kinks

Hose with SwiveLink can stretch to just under full length

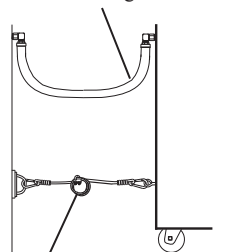
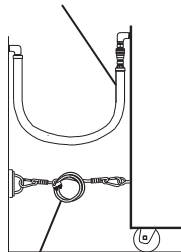

No.1 restrains so hose remains slack

No.1 extends fully before hose is able to

Instrucciones Generales

El propósito de este cable restringente es un aparato para prevenir que la manguera de gas sea extendida a su máximo. Instale este cable en línea, paralelo con el Conector de Gas. El Cable debe ser ajustado de modo que sea mas corto que el Conector de Gas.

AVISO: Este Aparato Restringente siempre tiene que estar conectado cuando el aparato esta en uso. Desconecte solamente cuando se esta cambiando de sitio, reparando o limpiando. Luego conecte de nuevo el restringente cuando el aparato se haya regresado a su posición normal.

Nota: El Aparato Restringente Es Un Requisito Debido A Las Siguietes Normas, Por ANSI:

Z21.69	Gas Connectors for Moveable Gas Appliances
Z21.41	Quick-Disconnect Couplings
Z83.11	Commercial Gas Ranges
Z83.12	Commercial Gas Ovens
Z83.13	Commercial Gas Fryers
Z223.1	National Fuel Gas Code Section 5.5.1.e
CAN/CGA 6.16	Connectors for Moveable Gas Appliances
CAN/CGA B.149.1	National Gas Installation Code (5.22.5)
B.149.2	Propane Installation Code (5.22.5)

Installations:

Wall Anchor

1. Locate stud or sturdy surface on wall where no.1 will be positioned, as closely as possible to appliance connector gas inlet and outlet connections. Then drill 1/4" hole through frame member of appliance.

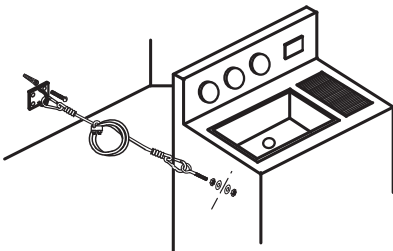

Nota: Sea extremadamente cuidadoso cuando perforo el hueco en el aparato para asegurarse que no ocurra daño a ninguna parte interna por el taladro. Use recomendaciones de la factoría para el aparato.

2. Enhebre la parte No.5 y deslice la parte No.6 en la parte No.7. Inserte la parte No.7 a través del hueco perforado y asegure dentro del aparato con la otra parte No.6 y No.4.

Instalación Del Cable

Junte cada parte No.8, (una) al No.9 y (la otra) al No.7.

Ajuste Del Cable

Usando la parte No.3, ajuste el largo extendido de la parte No.2 para prevenir retorcimiento o sobre doble del conector del aparato.

Instalación completa.
Manguera sin empate girador:

Instalación completa.
Manguera con empate girador:

La manguera debe ser suelta sin doblados o retorcidos.

Manguera con empate girador se puede extender casi hasta su máxima longitud.

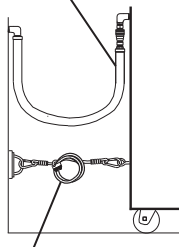

Parte No.1 restringe de modo que la manguera permanezca suelta.

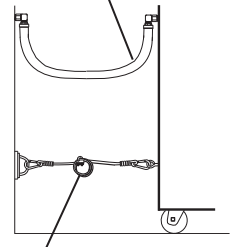

Parte No.1 se extiende cerca a la máxima longitud De la manguera.

Instructions Générales

Le but de câble retenant de dispositif être de ne jamais permettre au tuyau de gaz d'être entièrement ampleur étirée. Installer ce câble en ligne, parallèle le connecteur du gaz. Le câble devoir être ajuster de sort qu'il soit plus court que le connecteur du gaz.

Avertissement: Ce dispositif devoir toujours brancher quand l'appareil marcher. Débrancher seulement quand vous vous déplacer l'appareil pendant le nettoyage ou l'entretien. Puis brancher encore le câble retenant quand vous retourner l'appareil à sa position normale.

Noter : Il falloir un dispositif retenant par les étandards de l'ANSI suivant:

Z21.69	Gas Connectors for Moveable Gas Appliances
Z21.41	Quick-Disconnect Couplings
Z83.11	Commercial Gas Ranges
Z83.12	Commercial Gas Ovens
Z83.13	Commercial Gas Fryers
Z223.1	National Fuel Gas Code Section 5.5.1.e
CAN/CGA 6.16	Connectors for Moveable Gas Appliances
CAN/CGA B.149.1	National Gas Installation Code (5.22.5)
B.149.2	Propane Installation Code (5.22.5)

L'Installation

L'Ancre du Mur

1. Trouver la planche derrière le mur ou une surface solide où vous aller mettre N°.1, aussi près que possible au connecteur du gaz et les connexions de l'arrivée et de la sortie. Puis percer un trou 1/4" à travers le cadre de l'appareil.

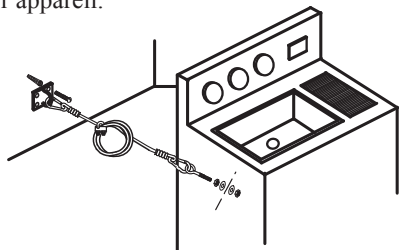

Noter: Il falloir prendre des soins quand vous percer le trou dans l'appareil pour être certain que vous n'aller pas dom-mager les parties internes de l'appareil. Utiliser les recommandations du fabri-cant de l'appareil.

2. Mettre N°.5 et faire glisser N°.6 sur N°.7. Insérer N°.7 à travers le trou percé et attacher dans l'appareil avec l'autre N°.6 et N°.4.

L'Installation du Câble

Attacher chaque N°.8, (un) à N°.4 et (l'autre) à N°.7.

Le Réglage du Câble

En utilisant N°.3 régler la longueur étirée de N°.2 pour empêcher plier le connecteur de l'appareil.

L'installation
achevée, Le
Tuyau sans le
lien pivotant:

Le tuyau devoir être lâche, sans des coudes ni des entortillements.

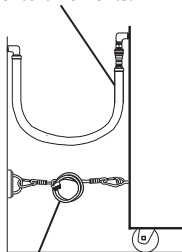

N°.1 retenir pour laisser lâche le tuyau.

L'installation
achevée, Le
Tuyau avec le
lien pivotant:

Le tuyau avec le lien pivotant pouvoir étirer un peu moins sa longueur entière.

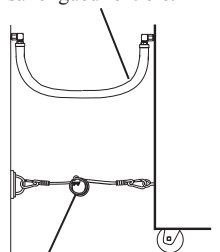

N°.1 aller étirer près de la longueur maximum du tuyau.

Allgemeine Anleitungen

Die Aufgabe dieses Rückhaltekabels, ist sicherzustellen, daß der Gasschlauch niemals zur vollen Länge ausgezogen werden kann. Montieren Sie dieses Kabel in einer geraden Linie parallel zu der Gasverbindung. Das Kabel sollte so abgemessen sein, daß es kürzer wie die Gasverbindung ist.

WARNUNG: Dieser Rückhalte-mechanismus muß immer angeschlossen sein, solange das Gerät in Betrieb genommen wird. Abtrennung des Kabels sollte nur erfolgen wenn die Vorrichtung bewegt, gewartet oder gereinigt wird. Das Rückhalte-kabel sollte sofort wiederverbunden werden, sobald das Gerät auf ihre ursprüngliche Position zurückbewegt wird.

Hinweis: Diese Rückhaltevorrichtung ist zwingend erforderlich, per ANSI-Standard:

Z21.69	Gas Connectors for Moveable Gas Appliances
Z21.41	Quick-Disconnect Couplings
Z83.11	Commercial Gas Ranges
Z83.12	Commercial Gas Ovens
Z83.13	Commercial Gas Fryers
Z223.1	National Fuel Gas Code Section 5.5.1.e
CAN/CGA 6.16	Connectors for Moveable Gas Appliances
CAN/CGA B.149.1	National Gas Installation Code (5.22.5)
B.149.2	Propane Installation Code (5.22.5)

Installations:

Wandbefestigung

1. Finden Sie den Stützbalken, oder andere geeignete Struktur an der Wand, an der Nr. 1 positioniert werden soll, so nahe wie möglich an der Gas Ein- und Ausgangsleitung. Dann bohren Sie 1/4" große Löcher durch den Rahmen des Gerätes.

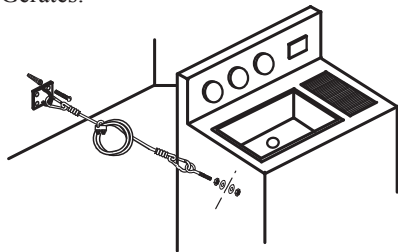

Hinweis: Äusserste Vorsicht ist geboten wenn durch die Vorrichtung gebohrt wird, um sicherzustellen, daß nahegelegene Komponente durch das Bohren nicht beschädigt werden. Greifen Sie auf die Vorschläge des Gerätefabrikanten zurück

2. Schrauben Sie Nr. 5 auf und ziehen Sie Nr. 6 auf Nr. 7. Nr. 7 durch die gebohrten Löcher einführen, und mit Hilfe von Nr. 6 und Nr. 4 befestigen.

Kabelinstallation

Befestigen Sie beide Nr. 8; (eine) zu Nr. 9 und (die andere) zu Nr. 7.

Einstellung des Kabels

Mit Hilfe von Nr. 3, stellen Sie die ausgezogene Länge der Nr. 2 so ein, daß überbiegen oder knicken der Geräteverbindung verhindert wird.

Beendete Installation für Schläuche ohne bewegbare Verbindung:

Schlauch sollte lose sein, ohne Biegungen oder Knicke.

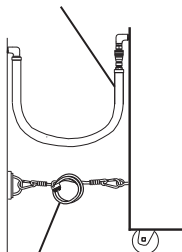

Auf Fußbodenhöhe: Nr. 1 verhindert Bewegung, sodaß die Leitung lose hängen kann.

Beendete Installation mit bewegbarer Verbindung:

Schläuche mit bewegbarer Verbindung, können fast bis zur vollen Länge ausgezogen werden.

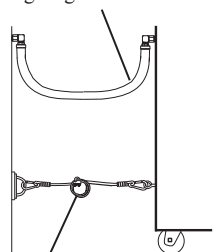

Auf Fußbodenhöhe: Nr. 1 ist fast zur maximalen Länge des Schlauches ausgestreckt.

RELATED T&S BRASS PRODUCT LINE



**HG Series
Gas Appliance
Connectors**

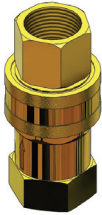

**AG-5C thru AG-5F
Quick-Disconnect**



**AG-6C thru AG-6F
SwiveLink**



**POSI-SET
Appliance Locating Device**



**AG-7C thru AG-7F
Gas Ball Valve**

T&S BRASS AND BRONZE WORKS, INC.

A firm commitment to application-engineered plumbing products

2 Saddleback Cove, P.O. Box 1088,
Travelers Rest, SC 29690

Phone: (864) 834-4102

Fax: (864) 834-3518

E-mail: tsbrass@tsbrass.com

T & S Brass-Europe
'De Veenhoeve'

Oude Nieuwveenseweg 84

2441 CW Nieuwveen

The Netherlands



RELIABILITY BUILT IN™