









DONE TO PERFECTION.

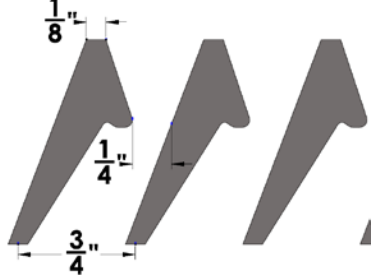

WOLF

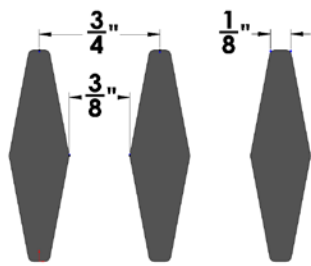
No worries.

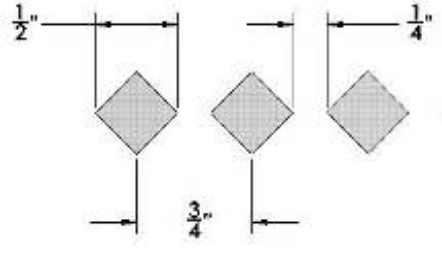
**VCCB & SCB
CHARBROILER
ACCESSORIES**

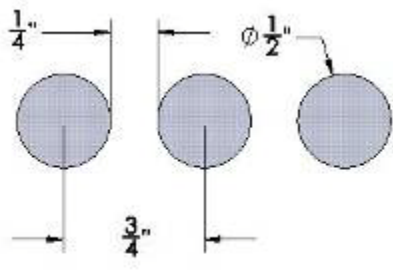
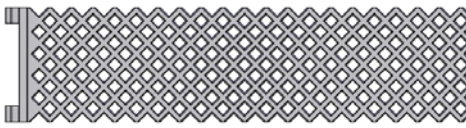
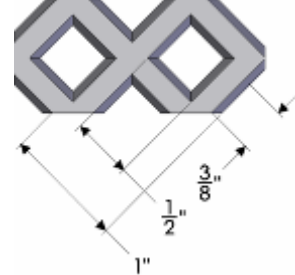
DESCRIPTION	GRATE PICTURE	PROFILE
<p>SERVICE PART: 710424</p> <p>CAST IRON SLANTED GRATE STANDARD ON ALL UNITS</p>		
<p>ACCESSORY CODE: GRATE-CDIA7</p> <p>CAST IRON DIAMOND GRATE</p>		
<p>ACCESSORY CODE: GRATE-SSDIA7</p> <p>CARBON STEEL DIAMOND FABRICATED GRATE</p>		
<p>ACCESSORY CODE: GRATE-RR0D7</p> <p>CARBON STEEL 1/2" ROUND ROD GRATE</p>		
<p>ACCESSORY CODE: GRATE-WAFFLE</p> <p>CAST IRON WAFFLE GRATE</p>		



DONE TO PERFECTION.



WOLF

No worries.

VCCB & SCB CHARBROILER ACCESSORIES

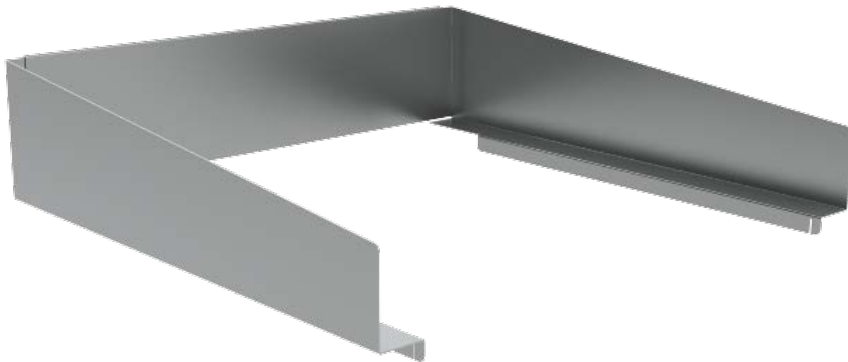

**ACCESSORY CODE:
SPLASH6-CBxx**

**STAINLESS STEEL SPLASH KIT.
"xx" REPRESENTS UNIT SIZE**



**ACCESSORY CODE:
PLTRAIL-VCCBxx**

**STAINLESS STEEL PLATE RAIL
"xx" REPRESENTS UNIT SIZE**