



STAINLESS STEEL 10" WIDE FOOD TABLE TUBULAR TRAY SHELVES Stationary & Drop-Down



Item #: _____	Qty #: _____
Model #: _____	
Project #: _____	

FEATURES:

Mounts to hot and cold food tables.
Tubular tray design.
Stationary Tray Shelves include fixed brackets.
Drop-down Tray Shelves include drop-down brackets.

MATERIALS:

Shelf: 1" Stainless steel tubing
Brackets: 10 gauge stainless steel

Length (L)	STATIONARY		DROP-DOWN		Cubic Feet
	MODEL	Weight	MODEL	Weight	
31-13/16"	TTR-2	8 lbs.	TTR-2D	9 lbs.	1
47-1/8"	TTR-3	10 lbs.	TTR-3D	11 lbs.	1
62-7/16"	TTR-4	13 lbs.	TTR-4D	14 lbs.	2
77-3/4"	TTR-5	17 lbs.	TTR-5D	18 lbs.	2
93-1/16"	TTR-6	22 lbs.	TTR-6D	23 lbs.	2

DETAILS and SPECIFICATIONS

TOL Overall: ± .500" Interior: ± .250"

ALL DIMENSIONS ARE TYPICAL

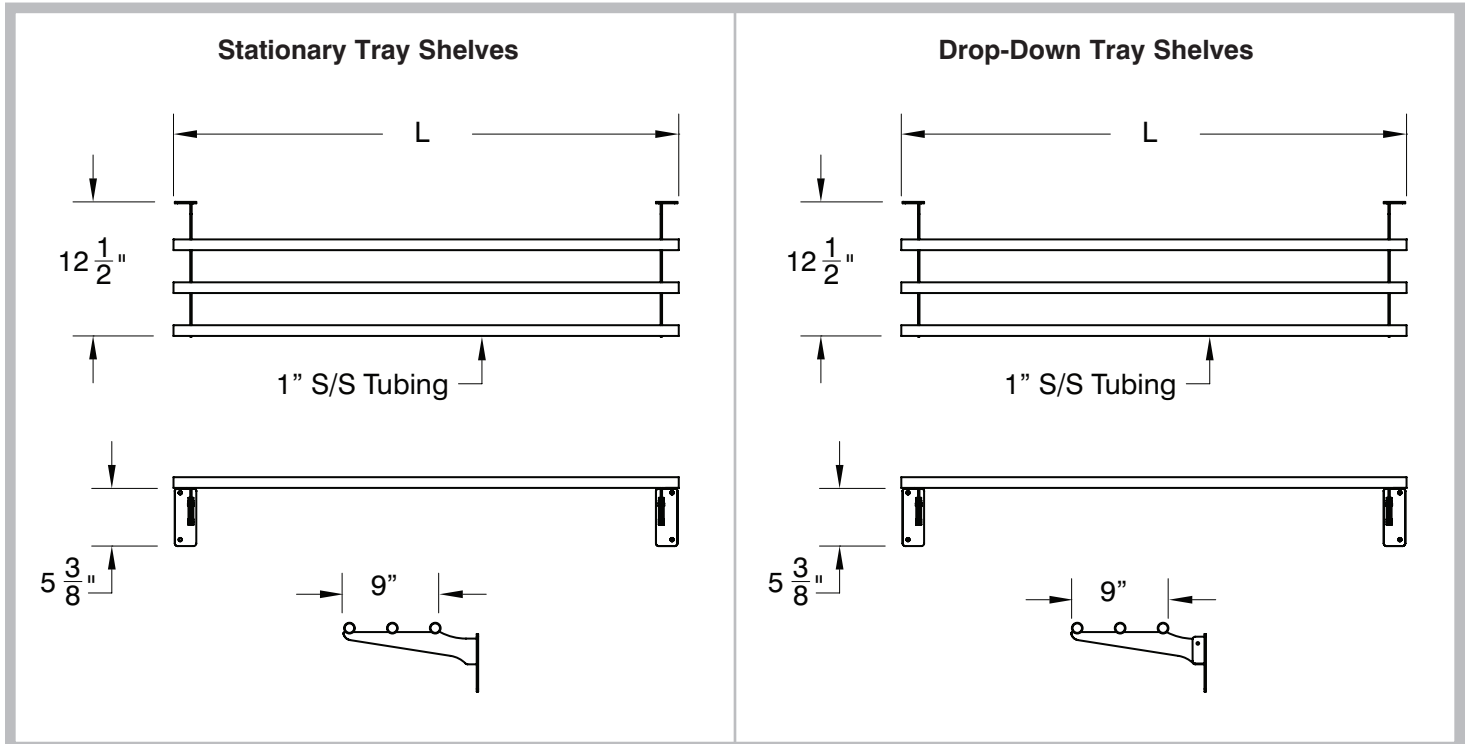

 www.advancetabco.com	<p>Customer Service Available To Assist You 1-800-645-3166 8:30 am - 7:00 pm E.S.T.</p> <p>For Orders & Customer Service: Email: customer@advancetabco.com or Fax: 631-242-6900</p>	<p>For Smart Fabrication™ Quotes: Email: smartfab@advancetabco.com or Fax: 631-586-2933</p>
--	--	---