

For Technical Support, call the number below.

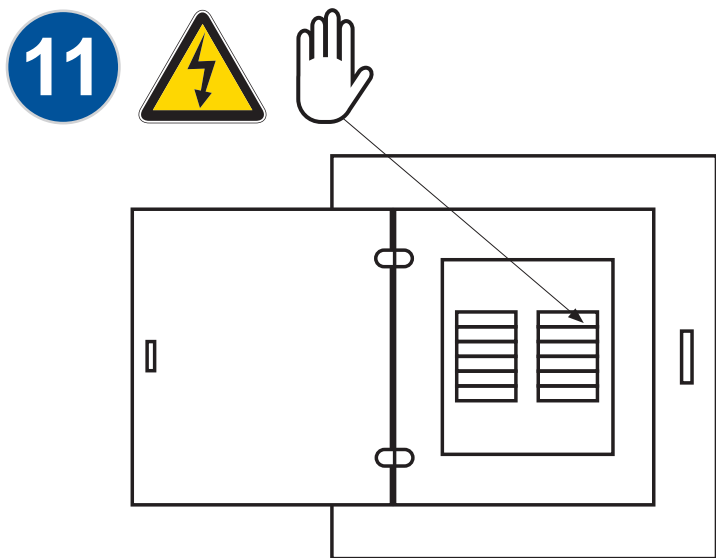

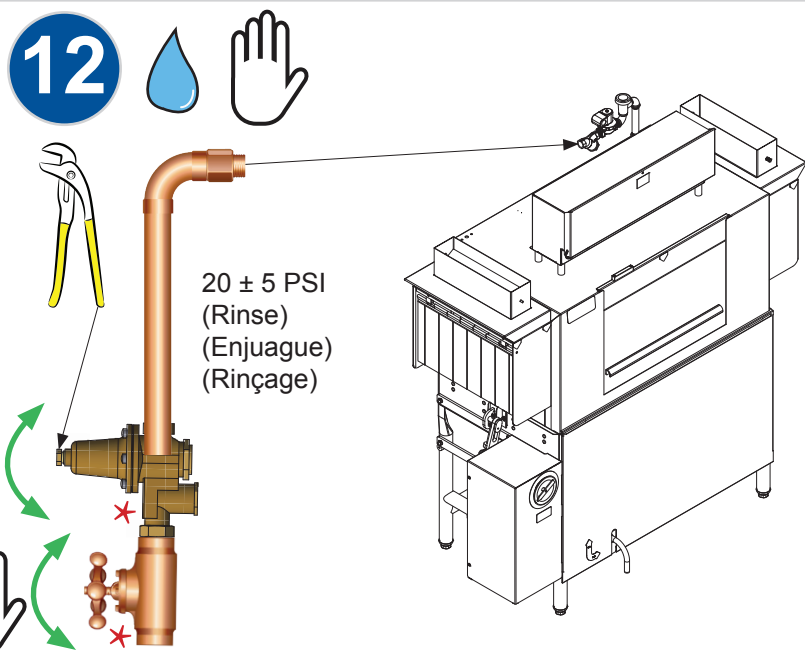







For the full AJ Manual, scan the QR Code below or go to our website.



For the full AJX Manual, scan the QR Code below or go to our website.



1.888.800.5672
www.jacksonwvs.com

-  = risk of electric shock
riesgo de electrocución
risque de décharge électrique
-  = caustic chemicals
químicos cáusticos
produits chimiques caustiques
-  = ground wire
cable a tierra
fil de terre
-  = verify
verificar
vérifier
-  = use fingers/hands
utilizar los dedos/manos
utilisez vos doigts/mains
-  = use eyes
utiliza tus ojos
utilisez vos yeux
-  = reference data plate
mire la placa de datos
regarder la plaque signalétique
-  = water
agua
eau
-  = not supplied
no se suministra
non fourni
-  = level
nivel
niveau

