

For Technical Support, call the number below.

For the full TempStar® Manual, scan the QR Code below or go to our website.

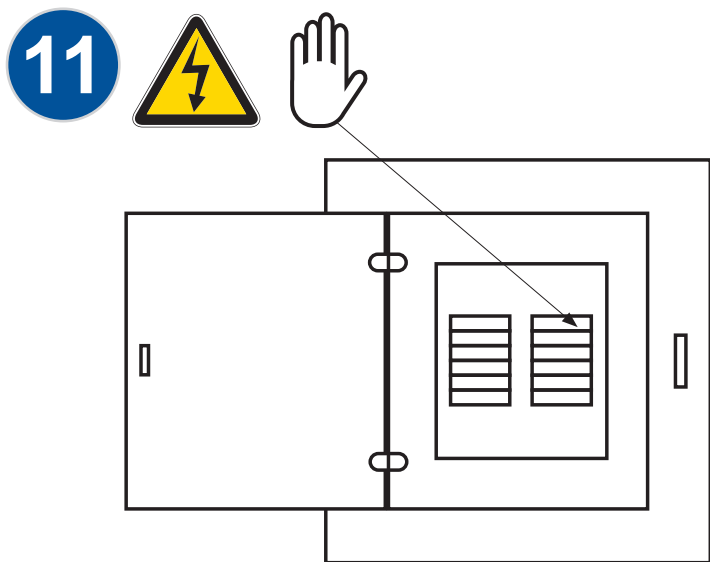

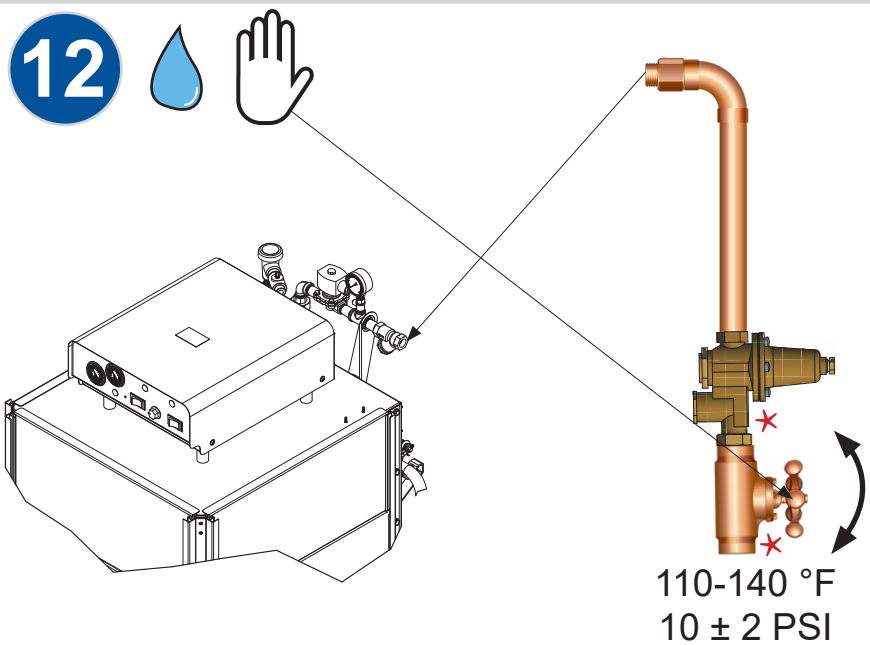









For the full TempStar® HH-E Manual, scan the QR Code below or go to our website.



1.888.800.5672  
www.jacksonwvs.com



-  = risk of electric shock  
riesgo de electrocución  
risque de décharge électrique
-  = caustic chemicals  
químicos cáusticos  
produits chimiques caustiques
-  = ground wire  
cable a tierra  
fil de terre
-  = verify  
verificar  
vérifier
-  = use fingers/hands  
utilizar los dedos/manos  
utilisez vos doigts/mains
-  = use eyes  
utiliza tus ojos  
utilisez vos yeux
-  = reference data plate  
mire la placa de datos  
regarder la plaque signalétique
-  = water  
agua  
eau
-  = not supplied  
no se suministra  
non fourni
-  = level  
nivel  
niveau

