

CAMSHELVING®

PREMIUM series | ELEMENTS series | BASICS PLUS series

Rust and Corrosion Free

Backed by a lifetime warranty against rust and corrosion, Camshelving storage systems eliminate the inconvenience and costs associated with restoring or replacing degraded shelving. Only Cambro offers Shelving for Life®.

Multi Environment Use

From freezers to coolers, ware washing or dry storage, Camshelving is designed to withstand all storage applications and temperatures—impervious to moisture, chemicals, salt, food acids, and humidity.

Easy to Clean

Cleaning shelving shouldn't be a major production. Whether daily or scheduled, cleaning can be done quickly and easily without interrupting storage space or normal, day-to-day operations.

Easy to Adjust & Assemble

Each shelf can be easily and independently adjusted to accommodate a variety of storage products and packages as product and storage needs change. Units ship in one box with pre-assembled post frames.

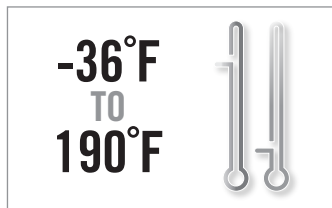

Maximized Space Utilization

Components have been thoughtfully designed to maximize storage space, even in space-restricted areas. Position shelves anywhere along the post, with dovetails spaced 4" apart.

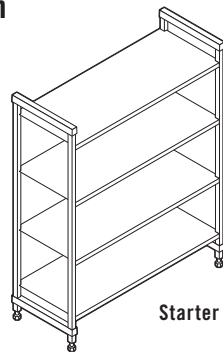

Starter Unit

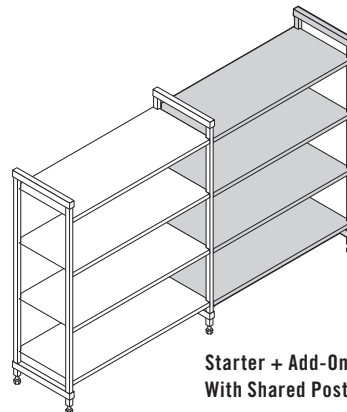

Starter + Add-On Unit With Shared Post

Shared Post

Space is money. Shelving units are designed to be interconnected, without compromising weight-bearing capacity all while maximizing usable storage space.

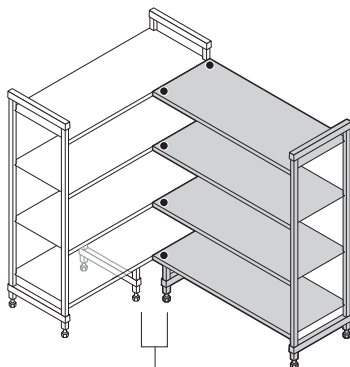

Corner Unit
Starter Unit + Add-On Unit using 1 set of Corner Connectors per shelf and 2 Dunnage Stands.

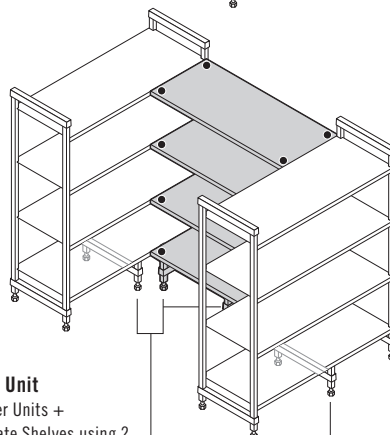

U-Shape Unit
Two Starter Units + Intermediate Shelves using 2 sets of Corner Connectors per shelf and 4 Dunnage Stands.

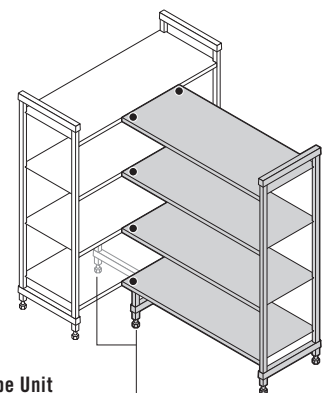

T-Shape Unit
Starter unit + Add-on unit using 1 set of corner connectors per shelf and 2 dunnage stands.

Corner Connectors ● = Corner Connectors

Convert unusable space into continuous, easy-access storage areas using corner connectors. (Corner connectors are for use only with shelves 24" - 48" long.)

Camshelving is covered under the following US Patents:

D498,664 S, D508,646 S, D512,867 S, D623,929 S, D624,764 S, D648,582 S, D630,935 S, D648,159 S, D651,433 S, D648,160 S, D697,391 S, D727,715 S, D728,347 S, D728,348 S, D707,994 S, D739,989 S, D663,912 S, D736,488 S, D739,989 S, US 6,981,454B2, D760,519 S.

CAMSHELVING® SERIES BUYERS GUIDE

All Camshelving lines offer a lifetime warranty against rust and corrosion for shelf plates, posts and traverses.



	PREMIUM series	ELEMENTS series	BASICS PLUS series
Shelf Depths	14", 18", 21", 24"	14", 18", 21", 24"	18", 21", 24"
Shelf Lengths	24", 30", 36", 42", 48", 54", 60", 72"	24", 30", 36", 42", 48", 54", 60", 72"	30", 36", 42", 48", 54", 60"
Post Heights	Stationary: 32", 56", 64", 72", 84" Mobile: 35", 59", 67", 75" (includes casters)	Stationary: 30", 64", 72", 84" Mobile: 27¼", 70¼", 78¼" (includes casters)	Stationary: 64", 72", 84"
Weight-Bearing Capacity (based on 24" - 48" length)	Stationary Unit: 800 lbs. per shelf, 2000 lbs. per unit. Mobile Unit: 750 lbs. per unit. Corner Unit: 400 lbs. per shelf, 1800 lbs. per unit.	Stationary Unit: 800 lbs. per shelf, 2000 lbs. per unit. Mobile Unit: 750 lbs. per unit. Corner Unit: 400 lbs. per shelf, 1800 lbs. per unit.	Stationary Unit: 700 lbs. per shelf, 1800 lbs. per unit. Corner Unit: 300 lbs. per shelf, 1350 lbs. per unit.
Shelf Plates	Interchangeable with Elements Series. Features Camguard® antimicrobial.	Interchangeable with Premium Series. Features Camguard antimicrobial.	Not interchangeable with Premium or Elements Series. Features Camguard antimicrobial.
Mobility	Available in Mobile and High Density Storage System.	Available in Mobile.	Not available.
Assembly	Quickest and easiest to assemble due to molded-in dovetails.	Simple to assemble. Contains separate dovetails that must be attached to the post.	Simple to assemble. Contains separate dovetails that must be attached to the post.
ACCESSORIES			
Bottom Shelf Dunnage Stand	✓	✓	✓
Shelf Rails	✓	✓	✓
Vertical Drying and Storage Cradle (Trays / Cutting Boards / Lids)	✓	✓	✓
Dome Drying and Storage Cradle	✓	✓	✓
Angled Drying and Storage Cradle	✓	✓	✓
Ultimate #10 Can Rack	✓	✓	
Shelf Divider Panel	✓	✓	✓
Shelf Divider Bar (for Food Pans or Food Boxes)	✓	✓	
Single Shelf Sheet Pan/Tray Rack	✓	✓	✓
Single Shelf Security Cage	✓	✓	✓
Full Wrap Security Cage	✓		
Pegboard and Hooks	✓	✓	✓

CAMSHELVING BASICS® PLUS SERIES SPACE REFERENCE GUIDE

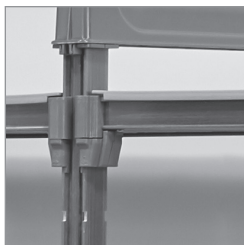
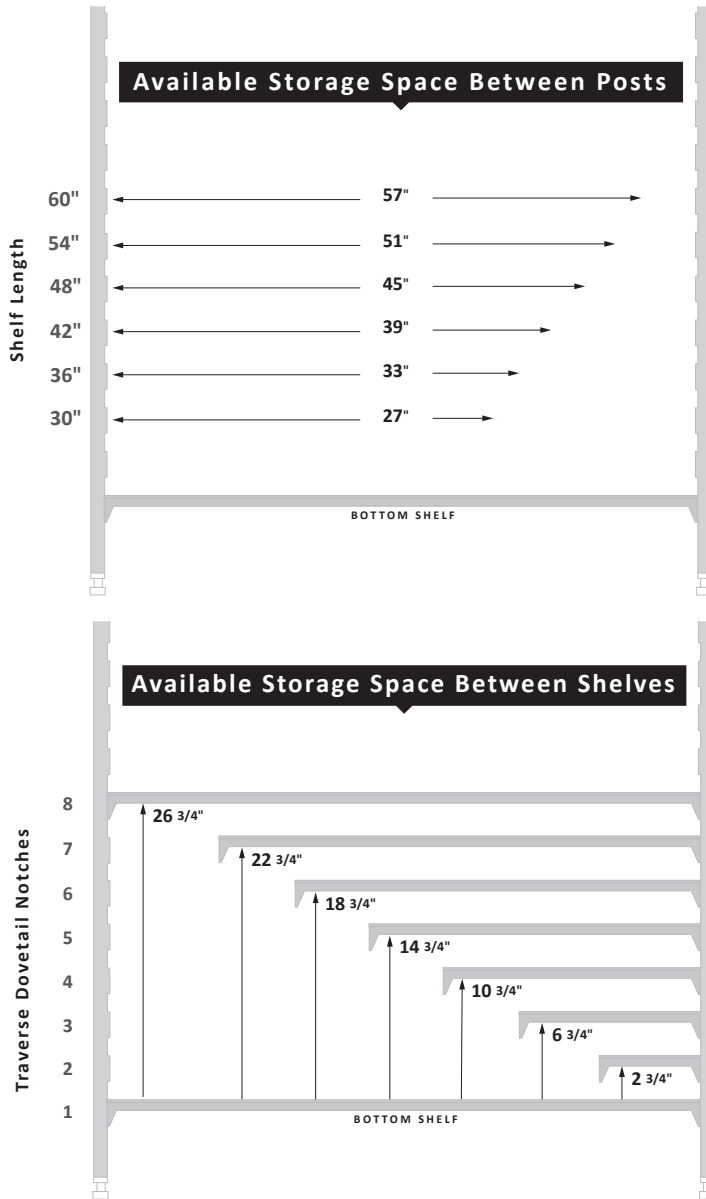

Traverse Dovetails

POST HEIGHT	NUMBER OF DOVETAILS PER POST*
64"	14
72"	16
84"	19

*Also equals maximum number of shelves per unit.

CAMSHELVING

BASICS[®] PLUS

series

STATIONARY

WHY CHOOSE BASICS PLUS?

Just because the budget is tight and storage needs are less rigorous, it doesn't mean that shelving performance and storage efficiencies should be compromised. Basics Plus Series is made from the same high performing, strong composite material as Elements Series and has the same design features. It's lighter in weight and less in cost but still strong enough to handle light to medium storage demands.

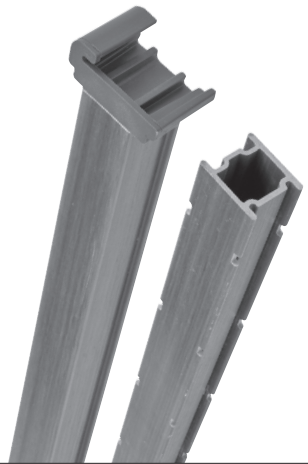

camguard.

ANTIMICROBIAL SHELF PLATES



COMPONENT



Post Connectors, Corner Connectors, Floor Fastener, Wall Fastener, Shelf Rails, Single Shelf Security Cage, Shelf Divider Panels and Identification Tags are not NSF listed.

Stationary Unit Sizes

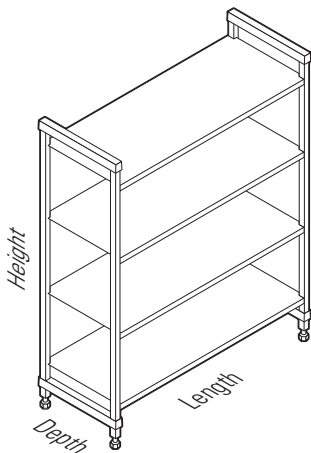

3 Depths		
18"	21"	24"
6 Lengths		
30"	36"	42"
48"	54"	60"
3 Heights		
64"	72"	84"



Weight Bearing Capacity

Weight must be evenly distributed across the entire shelf.

		UNIT LENGTH 30" – 48"	UNIT LENGTH 54" – 60"
SINGLE UNIT	Unit only	1,800 lbs.	1,800 lbs.
	Shelf only	700	500
	Unit with dunnage stand*	2,100	2,100
	Bottom shelf with dunnage stand*	1,000	800
CORNER UNIT** With 2 Dunnage Stands required	Unit only	1,350	—
	Shelf only	300	—
	Bottom shelf with dunnage stands*	450	—

*Dunnage Stands add stability and increase weight bearing capacity on bottom shelf only. Highly recommended for Starter Units 54" and longer, all Corner Units, U-Shape Units and units specified for heavier loads. (See Overall Length Quick Reference Guide).

**Corner connectors are for use only with shelves 30" - 48" long.

CAMSHELVING BASICS PLUS® SERIES – STARTER AND ADD-ON UNITS

V4 4-Shelf Vented Stationary Starter and Add-On Units

HEIGHTS	DEPTHS	LENGTHS	
3	3	6	
64"	18"	30"	48"
72"	21"	36"	54"
84"	24"	42"	60"

V5 5-Shelf Vented Stationary Starter and Add-On Units

HEIGHTS	DEPTHS	LENGTHS	
3	3	6	
64"	18"	30"	48"
72"	21"	36"	54"
84"	24"	42"	60"

S4 4-Shelf Solid Stationary Starter and Add-On Units

HEIGHTS	DEPTHS	LENGTHS	
3	3	6	
64"	18"	30"	48"
72"	21"	36"	54"
84"	24"	42"	60"

S5 5-Shelf Solid Stationary Starter and Add-On Units

HEIGHT	DEPTHS	LENGTHS	
1	3	6	
84"	18"	30"	48"
	21"	36"	54"
	24"	42"	60"

VS4 4-Shelf Vented and Solid Stationary Starter and Add-On Units (3 vented + 1 solid)

HEIGHTS	DEPTHS	LENGTHS	
3	3	6	
64"	18"	30"	48"
72"	21"	36"	54"
84"	24"	42"	60"

VS5 5-Shelf Vented and Solid Stationary Starter and Add-On Units (4 vented + 1 solid)

HEIGHT	DEPTHS	LENGTHS	
1	3	6	
84"	18"	30"	48"
	21"	36"	54"
	24"	42"	60"

V4

4-Shelf Vented Stationary Starter and Add-On Units

V5

5-Shelf Vented Stationary Starter and Add-On Units

Units ship complete in 1 box and include 1 or 2 factory assembled post kits, traverses, dovetails and shelf plates.

64"
HEIGHT

18"
DEPTH

Starter

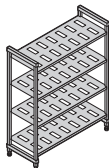

Add-On

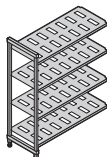

Starter

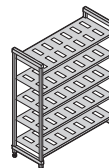

Add-On

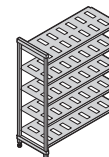

LENGTH	CODE	LIST PRICE EA.
30"	CBU183064V4	\$ 360.00
36"	CBU183664V4	395.00
42"	CBU184264V4	445.00
48"	CBU184864V4	465.00
54"	CBU185464V4	510.00
60"	CBU186064V4	545.00

LENGTH	CODE	LIST PRICE EA.
28¼"	CBA183064V4	\$ 289.00
34¼"	CBA183664V4	325.00
40¼"	CBA184264V4	375.00
46¼"	CBA184864V4	390.00
52¼"	CBA185464V4	440.00
58¼"	CBA186064V4	470.00

LENGTH	CODE	LIST PRICE EA.
30"	CBU183064V5	\$ 415.00
36"	CBU183664V5	460.00
42"	CBU184264V5	520.00
48"	CBU184864V5	545.00
54"	CBU185464V5	605.00
60"	CBU186064V5	645.00

LENGTH	CODE	LIST PRICE EA.
28¼"	CBA183064V5	\$ 345.00
34¼"	CBA183664V5	385.00
40¼"	CBA184264V5	450.00
46¼"	CBA184864V5	470.00
52¼"	CBA185464V5	530.00
58¼"	CBA186064V5	570.00

21"
DEPTH

30"	CBU213064V4	\$ 390.00
36"	CBU213664V4	435.00
42"	CBU214264V4	490.00
48"	CBU214864V4	510.00
54"	CBU215464V4	565.00
60"	CBU216064V4	605.00

28¼"	CBA213064V4	\$ 315.00
34¼"	CBA213664V4	360.00
40¼"	CBA214264V4	415.00
46¼"	CBA214864V4	435.00
52¼"	CBA215464V4	490.00
58¼"	CBA216064V4	530.00

30"	CBU213064V5	\$ 450.00
36"	CBU213664V5	505.00
42"	CBU214264V5	575.00
48"	CBU214864V5	600.00
54"	CBU215464V5	670.00
60"	CBU216064V5	715.00

28¼"	CBA213064V5	\$ 380.00
34¼"	CBA213664V5	430.00
40¼"	CBA214264V5	500.00
46¼"	CBA214864V5	525.00
52¼"	CBA215464V5	595.00
58¼"	CBA216064V5	640.00

24"
DEPTH

30"	CBU243064V4	\$ 410.00
36"	CBU243664V4	445.00
42"	CBU244264V4	495.00
48"	CBU244864V4	525.00
54"	CBU245464V4	575.00
60"	CBU246064V4	605.00

28¼"	CBA243064V4	\$ 335.00
34¼"	CBA243664V4	370.00
40¼"	CBA244264V4	420.00
46¼"	CBA244864V4	450.00
52¼"	CBA245464V4	500.00
58¼"	CBA246064V4	530.00

30"	CBU243064V5	\$ 475.00
36"	CBU243664V5	520.00
42"	CBU244264V5	580.00
48"	CBU244864V5	620.00
54"	CBU245464V5	680.00
60"	CBU246064V5	720.00

28¼"	CBA243064V5	\$ 400.00
34¼"	CBA243664V5	445.00
40¼"	CBA244264V5	505.00
46¼"	CBA244864V5	545.00
52¼"	CBA245464V5	605.00
58¼"	CBA246064V5	645.00

S4

4-Shelf Solid Stationary Starter and Add-On Units

VS4

4-Shelf Vented and Solid Stationary Starter and Add-On Units

(3 Vented + 1 Solid)

Units ship complete in 1 box and include 1 or 2 factory assembled post kits, traverses, dovetails and shelf plates.

64"
HEIGHT

18"
DEPTH

Starter

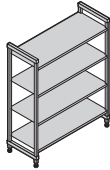

Add-On

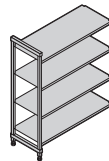

Starter

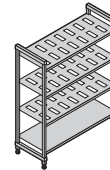

Add-On

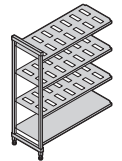

LENGTH	CODE	LIST PRICE EA.
30"	CBU183064S4	\$ 370.00
36"	CBU183664S4	410.00
42"	CBU184264S4	460.00
48"	CBU184864S4	475.00
54"	CBU185464S4	530.00
60"	CBU186064S4	565.00

LENGTH	CODE	LIST PRICE EA.
28¼"	CBA183064S4	\$ 298.00
34¼"	CBA183664S4	335.00
40¼"	CBA184264S4	390.00
46¼"	CBA184864S4	405.00
52¼"	CBA185464S4	455.00
58¼"	CBA186064S4	495.00

LENGTH	CODE	LIST PRICE EA.
30"	CBU183064VS4	\$ 365.00
36"	CBU183664VS4	400.00
42"	CBU184264VS4	450.00
48"	CBU184864VS4	465.00
54"	CBU185464VS4	515.00
60"	CBU186064VS4	550.00

LENGTH	CODE	LIST PRICE EA.
28¼"	CBA183064VS4	\$ 291.00
34¼"	CBA183664VS4	325.00
40¼"	CBA184264VS4	375.00
46¼"	CBA184864VS4	395.00
52¼"	CBA185464VS4	445.00
58¼"	CBA186064VS4	475.00

21"
DEPTH

30"	CBU213064S4	\$ 405.00
36"	CBU213664S4	450.00
42"	CBU214264S4	505.00
48"	CBU214864S4	530.00
54"	CBU215464S4	590.00
60"	CBU216064S4	625.00

28¼"	CBA213064S4	\$ 330.00
34¼"	CBA213664S4	375.00
40¼"	CBA214264S4	430.00
46¼"	CBA214864S4	455.00
52¼"	CBA215464S4	515.00
58¼"	CBA216064S4	555.00

30"	CBU213064VS4	\$ 395.00
36"	CBU213664VS4	435.00
42"	CBU214264VS4	495.00
48"	CBU214864VS4	515.00
54"	CBU215464VS4	570.00
60"	CBU216064VS4	610.00

28¼"	CBA213064VS4	\$ 320.00
34¼"	CBA213664VS4	365.00
40¼"	CBA214264VS4	420.00
46¼"	CBA214864VS4	440.00
52¼"	CBA215464VS4	495.00
58¼"	CBA216064VS4	535.00

24"
DEPTH

30"	CBU243064S4	\$ 425.00
36"	CBU243664S4	465.00
42"	CBU244264S4	515.00
48"	CBU244864S4	550.00
54"	CBU245464S4	600.00
60"	CBU246064S4	640.00

28¼"	CBA243064S4	\$ 350.00
34¼"	CBA243664S4	390.00
40¼"	CBA244264S4	440.00
46¼"	CBA244864S4	475.00
52¼"	CBA245464S4	525.00
58¼"	CBA246064S4	565.00

30"	CBU243064VS4	\$ 415.00
36"	CBU243664VS4	450.00
42"	CBU244264VS4	500.00
48"	CBU244864VS4	535.00
54"	CBU245464VS4	580.00
60"	CBU246064VS4	615.00

28¼"	CBA243064VS4	\$ 335.00
34¼"	CBA243664VS4	375.00
40¼"	CBA244264VS4	425.00
46¼"	CBA244864VS4	460.00
52¼"	CBA245464VS4	505.00
58¼"	CBA246064VS4	540.00

Color: Brushed Graphite (580).

V4

4-Shelf Vented Stationary Starter and Add-On Units

V5

5-Shelf Vented Stationary Starter and Add-On Units

Units ship complete in 1 box and include 1 or 2 factory assembled post kits, traverses, dovetails and shelf plates.

72"
HEIGHT

18"
DEPTH

Starter

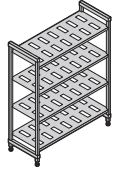

Add-On

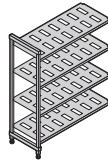

LENGTH	CODE	LIST PRICE EA.
30"	CBU183072V4	\$ 365.00
36"	CBU183672V4	400.00
42"	CBU184272V4	450.00
48"	CBU184872V4	465.00
54"	CBU185472V4	515.00
60"	CBU186072V4	550.00

LENGTH	CODE	LIST PRICE EA.
28¼"	CBA183072V4	\$ 290.00
34¼"	CBA183672V4	325.00
40¼"	CBA184272V4	375.00
46¼"	CBA184872V4	390.00
52¼"	CBA185472V4	440.00
58¼"	CBA186072V4	475.00

Starter

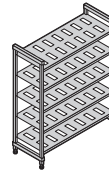

Add-On

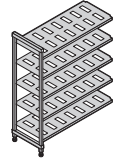

LENGTH	CODE	LIST PRICE EA.
30"	CBU183072V5	\$ 420.00
36"	CBU183672V5	465.00
42"	CBU184272V5	525.00
48"	CBU184872V5	545.00
54"	CBU185472V5	605.00
60"	CBU186072V5	650.00

LENGTH	CODE	LIST PRICE EA.
28¼"	CBA183072V5	\$ 345.00
34¼"	CBA183672V5	390.00
40¼"	CBA184272V5	450.00
46¼"	CBA184872V5	470.00
52¼"	CBA185472V5	530.00
58¼"	CBA186072V5	575.00

21"
DEPTH

30"	CBU213072V4	\$ 395.00
36"	CBU213672V4	435.00
42"	CBU214272V4	490.00
48"	CBU214872V4	515.00
54"	CBU215472V4	570.00
60"	CBU216072V4	605.00

28¼"	CBA213072V4	\$ 320.00
34¼"	CBA213672V4	360.00
40¼"	CBA214272V4	415.00
46¼"	CBA214872V4	435.00
52¼"	CBA215472V4	490.00
58¼"	CBA216072V4	530.00

30"	CBU213072V5	\$ 455.00
36"	CBU213672V5	510.00
42"	CBU214272V5	575.00
48"	CBU214872V5	605.00
54"	CBU215472V5	670.00
60"	CBU216072V5	720.00

28¼"	CBA213072V5	\$ 380.00
34¼"	CBA213672V5	430.00
40¼"	CBA214272V5	500.00
46¼"	CBA214872V5	525.00
52¼"	CBA215472V5	595.00
58¼"	CBA216072V5	645.00

24"
DEPTH

30"	CBU243072V4	\$ 410.00
36"	CBU243672V4	450.00
42"	CBU244272V4	500.00
48"	CBU244872V4	530.00
54"	CBU245472V4	575.00
60"	CBU246072V4	610.00

28¼"	CBA243072V4	\$ 335.00
34¼"	CBA243672V4	370.00
40¼"	CBA244272V4	420.00
46¼"	CBA244872V4	455.00
52¼"	CBA245472V4	500.00
58¼"	CBA246072V4	535.00

30"	CBU243072V5	\$ 475.00
36"	CBU243672V5	520.00
42"	CBU244272V5	585.00
48"	CBU244872V5	625.00
54"	CBU245472V5	680.00
60"	CBU246072V5	725.00

28¼"	CBA243072V5	\$ 400.00
34¼"	CBA243672V5	445.00
40¼"	CBA244272V5	505.00
46¼"	CBA244872V5	545.00
52¼"	CBA245472V5	605.00
58¼"	CBA246072V5	650.00

S4

4-Shelf Solid Stationary Starter and Add-On Units

VS4

4-Shelf Vented and Solid Stationary Starter and Add-On Units

(3 Vented + 1 Solid)

Units ship complete in 1 box and include 1 or 2 factory assembled post kits, traverses, dovetails and shelf plates.

72"
HEIGHT

Starter

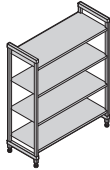

Add-On

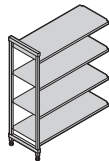

18"
DEPTH

LENGTH	CODE	LIST PRICE EA.
30"	CBU183072S4	\$ 375.00
36"	CBU183672S4	410.00
42"	CBU184272S4	465.00
48"	CBU184872S4	480.00
54"	CBU185472S4	535.00
60"	CBU186072S4	570.00

LENGTH	CODE	LIST PRICE EA.
28¼"	CBA183072S4	\$ 300.00
34¼"	CBA183672S4	340.00
40¼"	CBA184272S4	390.00
46¼"	CBA184872S4	405.00
52¼"	CBA185472S4	460.00
58¼"	CBA186072S4	495.00

Starter

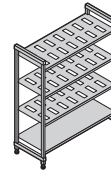

Add-On

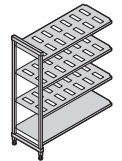

LENGTH	CODE	LIST PRICE EA.
30"	CBU183072VS4	\$ 365.00
36"	CBU183672VS4	405.00
42"	CBU184272VS4	455.00
48"	CBU184872VS4	470.00
54"	CBU185472VS4	520.00
60"	CBU186072VS4	555.00

LENGTH	CODE	LIST PRICE EA.
28¼"	CBA183072VS4	\$ 293.00
34¼"	CBA183672VS4	330.00
40¼"	CBA184272VS4	380.00
46¼"	CBA184872VS4	395.00
52¼"	CBA185472VS4	445.00
58¼"	CBA186072VS4	480.00

21"
DEPTH

30"	CBU213072S4	\$ 410.00
36"	CBU213672S4	450.00
42"	CBU214272S4	510.00
48"	CBU214872S4	535.00
54"	CBU215472S4	590.00
60"	CBU216072S4	630.00

28¼"	CBA213072S4	\$ 330.00
34¼"	CBA213672S4	375.00
40¼"	CBA214272S4	430.00
46¼"	CBA214872S4	460.00
52¼"	CBA215472S4	515.00
58¼"	CBA216072S4	555.00

30"	CBU213072VS4	\$ 400.00
36"	CBU213672VS4	440.00
42"	CBU214272VS4	495.00
48"	CBU214872VS4	520.00
54"	CBU215472VS4	575.00
60"	CBU216072VS4	610.00

28¼"	CBA213072VS4	\$ 320.00
34¼"	CBA213672VS4	365.00
40¼"	CBA214272VS4	420.00
46¼"	CBA214872VS4	440.00
52¼"	CBA215472VS4	500.00
58¼"	CBA216072VS4	535.00

24"
DEPTH

30"	CBU243072S4	\$ 425.00
36"	CBU243672S4	470.00
42"	CBU244272S4	520.00
48"	CBU244872S4	555.00
54"	CBU245472S4	605.00
60"	CBU246072S4	645.00

28¼"	CBA243072S4	\$ 350.00
34¼"	CBA243672S4	395.00
40¼"	CBA244272S4	445.00
46¼"	CBA244872S4	480.00
52¼"	CBA245472S4	530.00
58¼"	CBA246072S4	565.00

30"	CBU243072VS4	\$ 415.00
36"	CBU243672VS4	455.00
42"	CBU244272VS4	505.00
48"	CBU244872VS4	535.00
54"	CBU245472VS4	585.00
60"	CBU246072VS4	620.00

28¼"	CBA243072VS4	\$ 340.00
34¼"	CBA243672VS4	375.00
40¼"	CBA244272VS4	425.00
46¼"	CBA244872VS4	460.00
52¼"	CBA245472VS4	505.00
58¼"	CBA246072VS4	540.00

Color: Brushed Graphite (580).

V4

4-Shelf Vented Stationary Starter and Add-On Units

V5

5-Shelf Vented Stationary Starter and Add-On Units

Units ship complete in 1 box and include 1 or 2 factory assembled post kits, traverses, dovetails and shelf plates.

84"
HEIGHT

18"
DEPTH

Starter

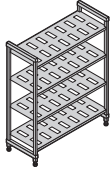

Add-On

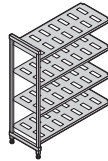

LENGTH	CODE	LIST PRICE EA.
30"	CBU183084V4	\$ 390.00
36"	CBU183684V4	425.00
42"	CBU184284V4	475.00
48"	CBU184884V4	490.00
54"	CBU185484V4	540.00
60"	CBU186084V4	570.00

LENGTH	CODE	LIST PRICE EA.
28¼"	CBA183084V4	\$ 300.00
34¼"	CBA183684V4	335.00
40¼"	CBA184284V4	385.00
46¼"	CBA184884V4	405.00
52¼"	CBA185484V4	450.00
58¼"	CBA186084V4	485.00

Starter

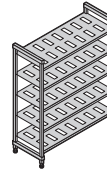

Add-On

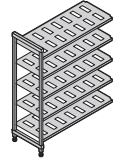

LENGTH	CODE	LIST PRICE EA.
30"	CBU183084V5	\$ 440.00
36"	CBU183684V5	485.00
42"	CBU184284V5	550.00
48"	CBU184884V5	570.00
54"	CBU185484V5	630.00
60"	CBU186084V5	670.00

LENGTH	CODE	LIST PRICE EA.
28¼"	CBA183084V5	\$ 355.00
34¼"	CBA183684V5	400.00
40¼"	CBA184284V5	460.00
46¼"	CBA184884V5	485.00
52¼"	CBA185484V5	545.00
58¼"	CBA186084V5	585.00

21"
DEPTH

30"	CBU213084V4	\$ 420.00
36"	CBU213684V4	460.00
42"	CBU214284V4	515.00
48"	CBU214884V4	535.00
54"	CBU215484V4	590.00
60"	CBU216084V4	630.00

28¼"	CBA213084V4	\$ 330.00
34¼"	CBA213684V4	370.00
40¼"	CBA214284V4	425.00
46¼"	CBA214884V4	450.00
52¼"	CBA215484V4	505.00
58¼"	CBA216084V4	540.00

30"	CBU213084V5	\$ 480.00
36"	CBU213684V5	530.00
42"	CBU214284V5	600.00
48"	CBU214884V5	625.00
54"	CBU215484V5	695.00
60"	CBU216084V5	740.00

28¼"	CBA213084V5	\$ 390.00
34¼"	CBA213684V5	445.00
40¼"	CBA214284V5	510.00
46¼"	CBA214884V5	540.00
52¼"	CBA215484V5	610.00
58¼"	CBA216084V5	655.00

24"
DEPTH

30"	CBU243084V4	\$ 435.00
36"	CBU243684V4	470.00
42"	CBU244284V4	520.00
48"	CBU244884V4	555.00
54"	CBU245484V4	600.00
60"	CBU246084V4	635.00

28¼"	CBA243084V4	\$ 345.00
34¼"	CBA243684V4	385.00
40¼"	CBA244284V4	430.00
46¼"	CBA244884V4	465.00
52¼"	CBA245484V4	510.00
58¼"	CBA246084V4	545.00

30"	CBU243084V5	\$ 500.00
36"	CBU243684V5	545.00
42"	CBU244284V5	605.00
48"	CBU244884V5	645.00
54"	CBU245484V5	705.00
60"	CBU246084V5	750.00

28¼"	CBA243084V5	\$ 410.00
34¼"	CBA243684V5	455.00
40¼"	CBA244284V5	520.00
46¼"	CBA244884V5	560.00
52¼"	CBA245484V5	615.00
58¼"	CBA246084V5	660.00

S4

4-Shelf Solid Stationary Starter and Add-On Units

S5

5-Shelf Solid Stationary Starter and Add-On Units

Units ship complete in 1 box and include 1 or 2 factory assembled post kits, traverses, dovetails and shelf plates.

84"
HEIGHT

Starter

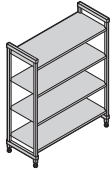

Add-On

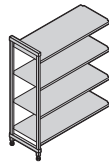

18"
DEPTH

LENGTH	CODE	LIST PRICE EA.
30"	CBU183084S4	\$ 395.00
36"	CBU183684S4	435.00
42"	CBU184284S4	490.00
48"	CBU184884S4	505.00
54"	CBU185484S4	555.00
60"	CBU186084S4	595.00

LENGTH	CODE	LIST PRICE EA.
28¼"	CBA183084S4	\$ 310.00
34¼"	CBA183684S4	350.00
40¼"	CBA184284S4	400.00
46¼"	CBA184884S4	420.00
52¼"	CBA185484S4	470.00
58¼"	CBA186084S4	505.00

Starter

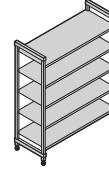

Add-On

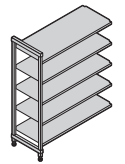

LENGTH	CODE	LIST PRICE EA.
30"	CBU183084S5	\$ 455.00
36"	CBU183684S5	500.00
42"	CBU184284S5	565.00
48"	CBU184884S5	585.00
54"	CBU185484S5	655.00
60"	CBU186084S5	700.00

LENGTH	CODE	LIST PRICE EA.
28¼"	CBA183084S5	\$ 370.00
34¼"	CBA183684S5	415.00
40¼"	CBA184284S5	480.00
46¼"	CBA184884S5	500.00
52¼"	CBA185484S5	565.00
58¼"	CBA186084S5	610.00

21"
DEPTH

30"	CBU213084S4	\$ 430.00
36"	CBU213684S4	475.00
42"	CBU214284S4	530.00
48"	CBU214884S4	560.00
54"	CBU215484S4	615.00
60"	CBU216084S4	655.00

28¼"	CBA213084S4	\$ 345.00
34¼"	CBA213684S4	390.00
40¼"	CBA214284S4	445.00
46¼"	CBA214884S4	470.00
52¼"	CBA215484S4	525.00
58¼"	CBA216084S4	565.00

30"	CBU213084S5	\$ 495.00
36"	CBU213684S5	550.00
42"	CBU214284S5	620.00
48"	CBU214884S5	655.00
54"	CBU215484S5	725.00
60"	CBU216084S5	775.00

28¼"	CBA213084S5	\$ 405.00
34¼"	CBA213684S5	460.00
40¼"	CBA214284S5	535.00
46¼"	CBA214884S5	565.00
52¼"	CBA215484S5	635.00
58¼"	CBA216084S5	685.00

24"
DEPTH

30"	CBU243084S4	\$ 450.00
36"	CBU243684S4	495.00
42"	CBU244284S4	545.00
48"	CBU244884S4	580.00
54"	CBU245484S4	630.00
60"	CBU246084S4	665.00

28¼"	CBA243084S4	\$ 360.00
34¼"	CBA243684S4	405.00
40¼"	CBA244284S4	455.00
46¼"	CBA244884S4	490.00
52¼"	CBA245484S4	540.00
58¼"	CBA246084S4	580.00

30"	CBU243084S5	\$ 520.00
36"	CBU243684S5	570.00
42"	CBU244284S5	635.00
48"	CBU244884S5	680.00
54"	CBU245484S5	740.00
60"	CBU246084S5	790.00

28¼"	CBA243084S5	\$ 430.00
34¼"	CBA243684S5	485.00
40¼"	CBA244284S5	545.00
46¼"	CBA244884S5	590.00
52¼"	CBA245484S5	655.00
58¼"	CBA246084S5	700.00

Color: Brushed Graphite (580).

VS4

4-Shelf Vented and Solid Stationary Starter and Add-On Units

(3 vented + 1 solid)

VS5

5-Shelf Vented and Solid Stationary Starter and Add-On Units

(4 vented + 1 solid)

Units ship complete in 1 box and include 1 or 2 factory assembled post kits, traverses, dovetails and shelf plates.

84"

HEIGHT

18"

DEPTH

Starter

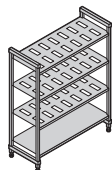

Add-On

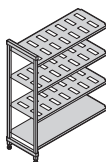

LENGTH	CODE	LIST PRICE EA.
30"	CBU183084VS4	\$ 390.00
36"	CBU183684VS4	425.00
42"	CBU184284VS4	475.00
48"	CBU184884VS4	495.00
54"	CBU185484VS4	545.00
60"	CBU186084VS4	575.00

LENGTH	CODE	LIST PRICE EA.
28¼"	CBA183084VS4	\$ 305.00
34¼"	CBA183684VS4	340.00
40¼"	CBA184284VS4	390.00
46¼"	CBA184884VS4	405.00
52¼"	CBA185484VS4	455.00
58¼"	CBA186084VS4	490.00

Starter

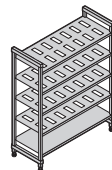

Add-On

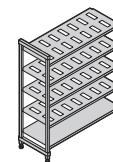

LENGTH	CODE	LIST PRICE EA.
30"	CBU183084VS5	\$ 445.00
36"	CBU183684VS5	490.00
42"	CBU184284VS5	550.00
48"	CBU184884VS5	575.00
54"	CBU185484VS5	635.00
60"	CBU186084VS5	675.00

LENGTH	CODE	LIST PRICE EA.
28¼"	CBA183084VS5	\$ 360.00
34¼"	CBA183684VS5	405.00
40¼"	CBA184284VS5	465.00
46¼"	CBA184884VS5	485.00
52¼"	CBA185484VS5	550.00
58¼"	CBA186084VS5	590.00

21"

DEPTH

30"	CBU213084VS4	\$ 420.00
36"	CBU213684VS4	465.00
42"	CBU214284VS4	520.00
48"	CBU214884VS4	540.00
54"	CBU215484VS4	595.00
60"	CBU216084VS4	635.00

28¼"	CBA213084VS4	\$ 335.00
34¼"	CBA213684VS4	375.00
40¼"	CBA214284VS4	430.00
46¼"	CBA214884VS4	455.00
52¼"	CBA215484VS4	510.00
58¼"	CBA216084VS4	545.00

30"	CBU213084VS5	\$ 480.00
36"	CBU213684VS5	535.00
42"	CBU214284VS5	605.00
48"	CBU214884VS5	630.00
54"	CBU215484VS5	700.00
60"	CBU216084VS5	750.00

28¼"	CBA213084VS5	\$ 395.00
34¼"	CBA213684VS5	445.00
40¼"	CBA214284VS5	515.00
46¼"	CBA214884VS5	545.00
52¼"	CBA215484VS5	615.00
58¼"	CBA216084VS5	660.00

24"

DEPTH

30"	CBU243084VS4	\$ 440.00
36"	CBU243684VS4	475.00
42"	CBU244284VS4	525.00
48"	CBU244884VS4	560.00
54"	CBU245484VS4	605.00
60"	CBU246084VS4	640.00

28¼"	CBA243084VS4	\$ 350.00
34¼"	CBA243684VS4	390.00
40¼"	CBA244284VS4	440.00
46¼"	CBA244884VS4	470.00
52¼"	CBA245484VS4	520.00
58¼"	CBA246084VS4	555.00

30"	CBU243084VS5	\$ 505.00
36"	CBU243684VS5	550.00
42"	CBU244284VS5	610.00
48"	CBU244884VS5	655.00
54"	CBU245484VS5	710.00
60"	CBU246084VS5	755.00

28¼"	CBA243084VS5	\$ 415.00
34¼"	CBA243684VS5	460.00
40¼"	CBA244284VS5	525.00
46¼"	CBA244884VS5	565.00
52¼"	CBA245484VS5	625.00
58¼"	CBA246084VS5	665.00



Stationary Post Kits

Ships **unassembled** in 1 box. Includes 2 stationary posts, post connectors and post connector wedges.



64"
HEIGHT

CODE	DIMENSIONS D x H	LIST PRICE EA.
CBPK1864	18" x 64"	\$ 72.80
CBPK2164	21" x 64"	74.65
CBPK2464	24" x 64"	75.30

72"
HEIGHT

CBPK1872	18" x 72"	\$ 74.45
CBPK2172	21" x 72"	76.25
CBPK2472	24" x 72"	76.90

84"
HEIGHT

CBPK1884	18" x 84"	\$ 86.10
CBPK2184	21" x 84"	87.85
CBPK2484	24" x 84"	88.45

Color: Brushed Graphite (580).

V1

Single Vented Shelf Kits

S1

Single Solid Shelf Kits

Includes 2 shelf traverses, traverse dovetails and vented or solid shelf plates. Ships in 1 box.

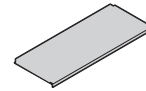
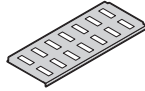

18"
DEPTH

CODE	DIMENSIONS D x L	LIST PRICE EA.
CBSK1830V1	18" x 30"	\$ 53.95
CBSK1836V1	18" x 36"	62.85
CBSK1842V1	18" x 42"	75.10
CBSK1848V1	18" x 48"	79.45
CBSK1854V1	18" x 54"	91.55
CBSK1860V1	18" x 60"	99.80

18"
DEPTH

CODE	DIMENSIONS D x L	LIST PRICE EA.
CBSK1830S1	18" x 30"	\$ 56.30
CBSK1836S1	18" x 36"	65.85
CBSK1842S1	18" x 42"	78.85
CBSK1848S1	18" x 48"	82.95
CBSK1854S1	18" x 54"	96.10
CBSK1860S1	18" x 60"	105.00

21"
DEPTH

CBSK2130V1	21" x 30"	\$ 60.65
CBSK2136V1	21" x 36"	71.05
CBSK2142V1	21" x 42"	84.85
CBSK2148V1	21" x 48"	90.05
CBSK2154V1	21" x 54"	104.00
CBSK2160V1	21" x 60"	113.00

21"
DEPTH

CBSK2130S1	21" x 30"	\$ 63.90
CBSK2136S1	21" x 36"	74.90
CBSK2142S1	21" x 42"	88.95
CBSK2148S1	21" x 48"	95.70
CBSK2154S1	21" x 54"	110.00
CBSK2160S1	21" x 60"	119.00

24"
DEPTH

CBSK2430V1	24" x 30"	\$ 64.65
CBSK2436V1	24" x 36"	73.70
CBSK2442V1	24" x 42"	86.00
CBSK2448V1	24" x 48"	94.10
CBSK2454V1	24" x 54"	106.00
CBSK2460V1	24" x 60"	114.00

24"
DEPTH

CBSK2430S1	24" x 30"	\$ 68.25
CBSK2436S1	24" x 36"	79.00
CBSK2442S1	24" x 42"	91.50
CBSK2448S1	24" x 48"	100.20
CBSK2454S1	24" x 54"	113.00
CBSK2460S1	24" x 60"	122.00

V4 4-Shelf Vented Kits

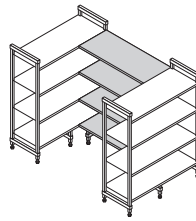

S4 4-Shelf Solid Kits

Includes 8 shelf traverses, traverse dovetails and vented or solid shelf plates.
Ships in 1 box. Install with 8 sets of corner connectors (CBCC8) to create a U-shape unit.

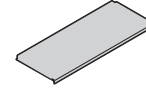
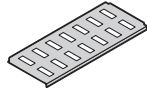

18"
DEPTH

CODE	DIMENSIONS D x L	LIST PRICE EA.
CBSK1836V4	18" x 36"	\$ 251.00
CBSK1842V4	18" x 42"	300.00
CBSK1848V4	18" x 48"	320.00

18"
DEPTH

CODE	DIMENSIONS D x L	LIST PRICE EA.
CBSK1836S4	18" x 36"	\$ 263.00
CBSK1842S4	18" x 42"	315.00
CBSK1848S4	18" x 48"	330.00

21"
DEPTH

CBSK2136V4	21" x 36"	\$ 284.00
CBSK2142V4	21" x 42"	340.00
CBSK2148V4	21" x 48"	360.00

21"
DEPTH

CBSK2136S4	21" x 36"	\$ 300.00
CBSK2142S4	21" x 42"	355.00
CBSK2148S4	21" x 48"	385.00

24"
DEPTH

CBSK2436V4	24" x 36"	\$ 295.00
CBSK2442V4	24" x 42"	345.00
CBSK2448V4	24" x 48"	375.00

24"
DEPTH

CBSK2436S4	24" x 36"	\$ 315.00
CBSK2442S4	24" x 42"	365.00
CBSK2448S4	24" x 48"	400.00

V5 5-Shelf Vented Kits

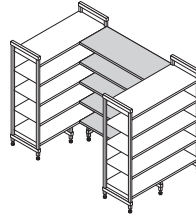

S5 5-Shelf Solid Kits

Includes 10 shelf traverses, traverse dovetails and vented or solid shelf plates.
Ships in 1 box. Install with 10 sets of corner connectors (CBCC10) to create a U-shape unit.

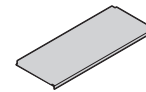
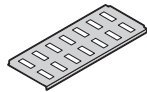

18"
DEPTH

CODE	DIMENSIONS D x L	LIST PRICE EA.
CBSK1836V5	18" x 36"	\$ 315.00
CBSK1842V5	18" x 42"	375.00
CBSK1848V5	18" x 48"	395.00

18"
DEPTH

CODE	DIMENSIONS D x L	LIST PRICE EA.
CBSK1836S5	18" x 36"	\$ 330.00
CBSK1842S5	18" x 42"	395.00
CBSK1848S5	18" x 48"	415.00

21"
DEPTH

CBSK2136V5	21" x 36"	\$ 355.00
CBSK2142V5	21" x 42"	425.00
CBSK2148V5	21" x 48"	450.00

21"
DEPTH

CBSK2136S5	21" x 36"	\$ 375.00
CBSK2142S5	21" x 42"	445.00
CBSK2148S5	21" x 48"	480.00

24"
DEPTH

CBSK2436V5	24" x 36"	\$ 370.00
CBSK2442V5	24" x 42"	430.00
CBSK2448V5	24" x 48"	470.00

24"
DEPTH

CBSK2436S5	24" x 36"	\$ 395.00
CBSK2442S5	24" x 42"	460.00
CBSK2448S5	24" x 48"	500.00

VS4 4-Shelf Kits

(3 Vented + 1 Solid)

Includes 8 shelf traverses, traverse dovetails and vented and solid shelf plates. Ships in 1 box. Install with 8 sets of corner connectors (CBCC8) to create a U-shape unit.

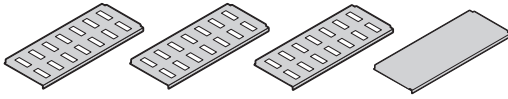

18"
DEPTH

CODE	DIMENSIONS D x L	LIST PRICE EA.
CBSK1836VS4	18" x 36"	\$ 254.00
CBSK1842VS4	18" x 42"	305.00
CBSK1848VS4	18" x 48"	320.00

21"
DEPTH

CBSK2136VS4	21" x 36"	\$ 288.00
CBSK2142VS4	21" x 42"	345.00
CBSK2148VS4	21" x 48"	365.00

24"
DEPTH

CBSK2436VS4	24" x 36"	\$ 300.00
CBSK2442VS4	24" x 42"	350.00
CBSK2448VS4	24" x 48"	380.00

VS5 5-Shelf Kits

(4 Vented + 1 Solid)

Includes 10 shelf traverses, traverse dovetails and vented and solid shelf plates. Ships in 1 box. Install with 10 sets of corner connectors (CBCC10) to create a U-shape unit.

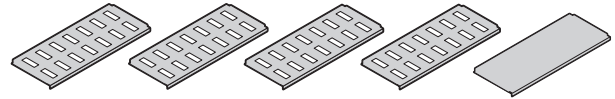

18"
DEPTH

CODE	DIMENSIONS D x L	LIST PRICE EA.
CBSK1836VS5	18" x 36"	\$ 315.00
CBSK1842VS5	18" x 42"	380.00
CBSK1848VS5	18" x 48"	400.00

21"
DEPTH

CBSK2136VS5	21" x 36"	\$ 360.00
CBSK2142VS5	21" x 42"	430.00
CBSK2148VS5	21" x 48"	455.00

24"
DEPTH

CBSK2436VS5	24" x 36"	\$ 375.00
CBSK2442VS5	24" x 42"	435.00
CBSK2448VS5	24" x 48"	475.00

Color: Brushed Graphite (580).



Corner Connectors

For use only with shelves 30" - 48" long. Unique patented design ensures maximum shelf space utilization. Use 1 set per shelf to connect starter and add-on units in corners. Connect 4 or 5 intermediate shelves between 2 starter units (2 sets required per shelf). Available as a single set or 8 or 10 set packs.

CODE	DESCRIPTION	LIST PRICE EA.
CBCC1	1 Set for 1 Shelf	\$ 5.95
CBCC8	8 Sets for 4 Shelves	47.45
CBCC10	10 Sets for 5 Shelves	59.35

Color: Brushed Graphite (580).

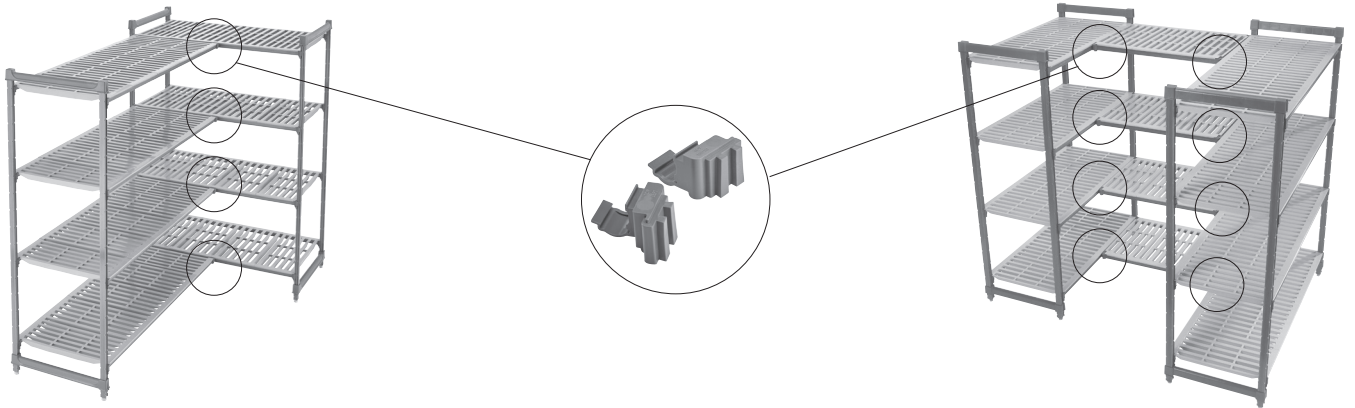

Bottom Shelf Dunnage Stands

Increase weight bearing capacity on bottom shelf only. Add to any shelf length. Highly recommended for starter units 54" and longer and all corner units, intermediate units and units specified for heavier load volume on and off bottom shelves.

CODE	DIMENSIONS D x H	LIST PRICE EA.
Dunnage Stand – Low (bottom shelf installed on lowest set of open post locations for dovetails)		
CBDS18H6	18" x 6¾"	\$ 54.35
CBDS21H6	21" x 6¾"	55.80
CBDS24H6	24" x 6¾"	57.10
Dunnage Stand – Tall (bottom shelf installed up on 2nd set of open post locations for dovetails)		
CBDS18H10	18" x 10¾"	54.55
CBDS21H10	21" x 10¾"	56.00
CBDS24H10	24" x 10¾"	57.35

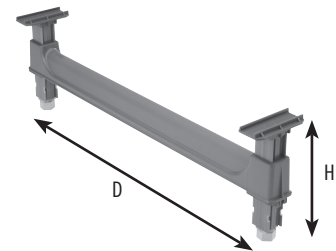
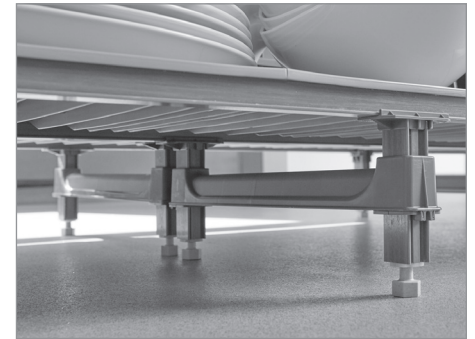

Bottom Shelf with Dunnage Stand

UNIT LENGTH	WEIGHT BEARING
Standard Unit	
30" - 48"	1,000 lbs.
54" - 60"	800
Corner Unit with 2 Dunnage Stands	
30" - 48"	450

Case Pack: 1 **Color:** Brushed Graphite (580).

Shelf Traverses

Add single stationary traverse on the back of a stationary unit for extra support when significant space is required between the bottom and second shelf shelf or when placing rolling equipment under the first shelf. Traverse dovetails included.

LENGTH	SINGLE PACK CODE*	LIST PRICE EA.	DOUBLE PACK CODE**	LIST PRICE EA.
30"	CBTR30	\$ 29.20	CBTR302PK	\$ 53.05
36"	CBTR36	29.40	CBTR362PK	53.45
42"	CBTR42	32.65	CBTR422PK	59.20
48"	CBTR48	35.70	CBTR482PK	64.90
54"	CBTR54	38.95	CBTR542PK	70.65
60"	CBTR60	41.90	CBTR602PK	76.15

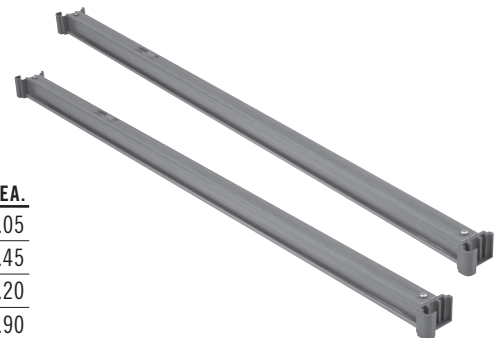

*Case Pack: 1 **Case Pack: 2 **Color:** Brushed Graphite (580).

FREE CAMSHELVING® DESIGN SERVICE

Take the guesswork out of creating your perfect shelving layout. Let our expert shelving consultants prepare a free layout that optimizes your space to create the most storage options.

Here's what you'll get:

- 2D Floor Plan
- 3D Floor Plan
- Itemized product list by room/area
- All within 48 business-day hours

It's Simple! To Get Started, Please Provide:

- Project Name
- Storage Room Type (freezer / cooler)
- Room(s) Dimensions (L x W x H)
- Doorway / Entryway Location & Dimension
- Obstructions (condenser / pipes)
- Additional Preferences / Requirements

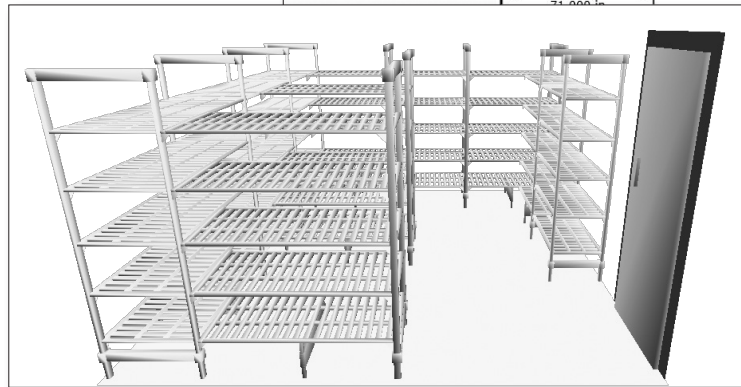
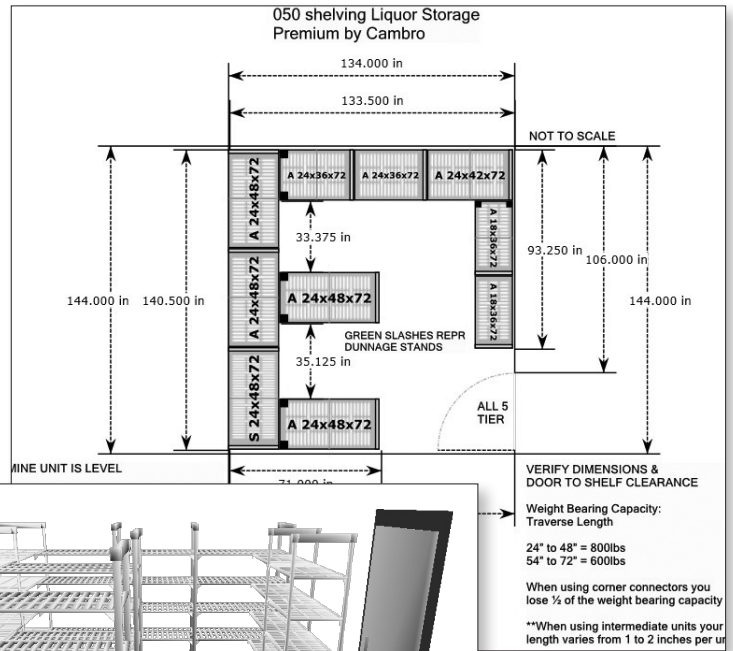

Request a Free
3D Shelving Layout

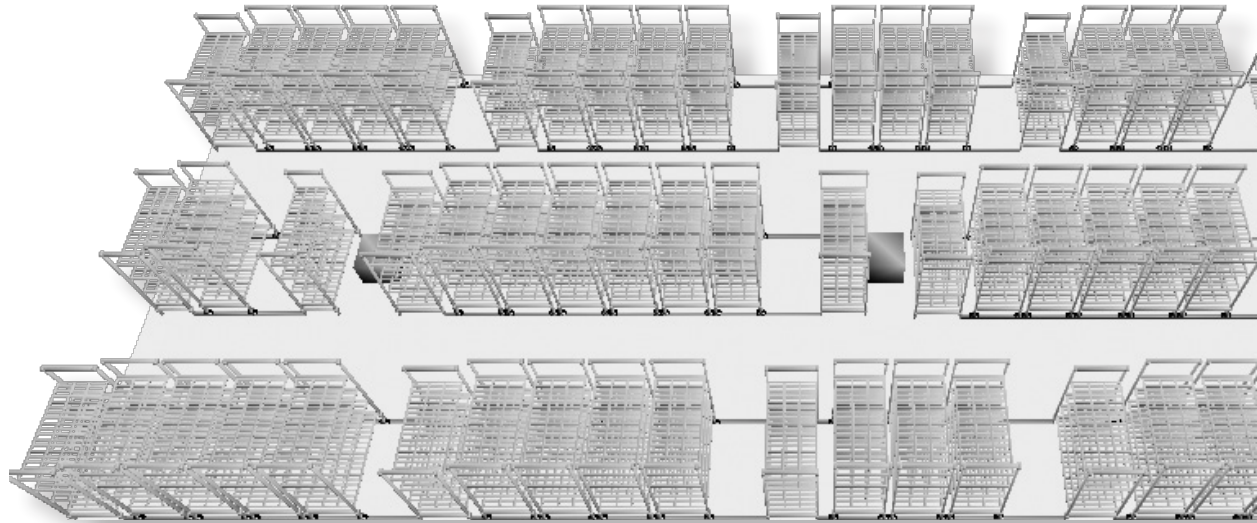

Email shelving@cambro.com or call TOLL FREE (877) 737-0663.