



SHELVING for LIFE®

Camshelving® Premium, Elements & Basics Plus Series



2021 Product Specification and Price List
Prices Effective April 15, 2021

CAMBRO
TRUSTED FOR GENERATIONS™

www.cambro.com

CAMSHELVING®

PREMIUM series | ELEMENTS series | BASICS PLUS series

Rust and Corrosion Free

Backed by a lifetime warranty against rust and corrosion, Camshelving storage systems eliminate the inconvenience and costs associated with restoring or replacing degraded shelving. Only Cambro offers Shelving for Life®.

Multi Environment Use

From freezers to coolers, ware washing or dry storage, Camshelving is designed to withstand all storage applications and temperatures—impervious to moisture, chemicals, salt, food acids, and humidity.

Easy to Clean

Cleaning shelving shouldn't be a major production. Whether daily or scheduled, cleaning can be done quickly and easily without interrupting storage space or normal, day-to-day operations.

Easy to Adjust & Assemble

Each shelf can be easily and independently adjusted to accommodate a variety of storage products and packages as product and storage needs change. Units ship in one box with pre-assembled post frames.

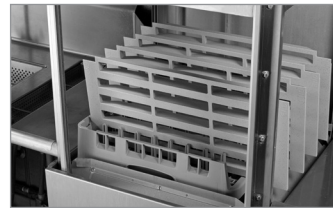
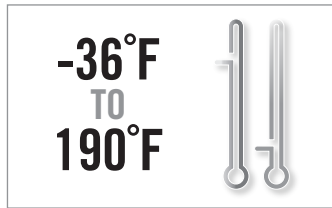

Maximized Space Utilization

Components have been thoughtfully designed to maximize storage space, even in space-restricted areas. Position shelves anywhere along the post, with dovetails spaced 4" apart.

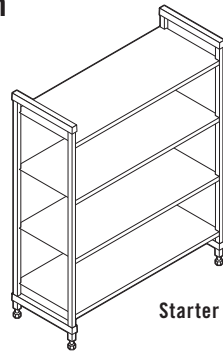

Starter Unit

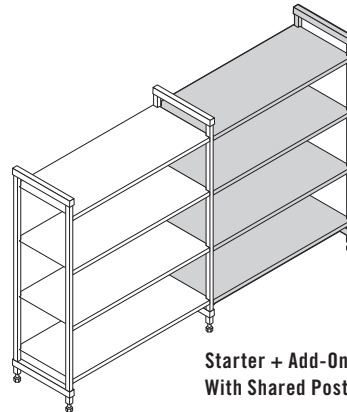

Starter + Add-On Unit With Shared Post

Shared Post

Space is money. Shelving units are designed to be interconnected, without compromising weight-bearing capacity all while maximizing usable storage space.

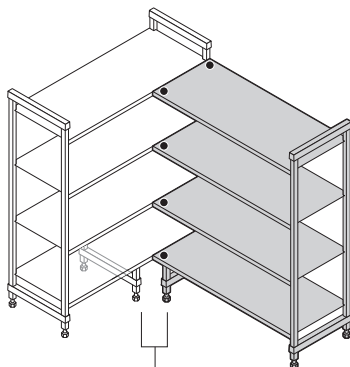

Corner Unit
Starter Unit + Add-On Unit using 1 set of Corner Connectors per shelf and 2 Dunnage Stands.

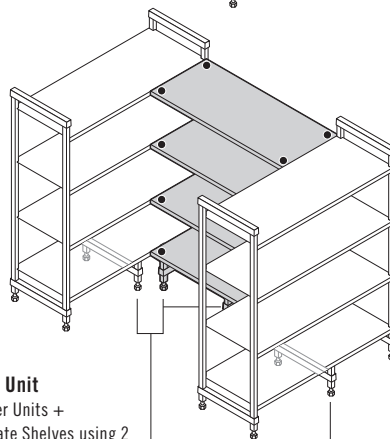

U-Shape Unit
Two Starter Units + Intermediate Shelves using 2 sets of Corner Connectors per shelf and 4 Dunnage Stands.

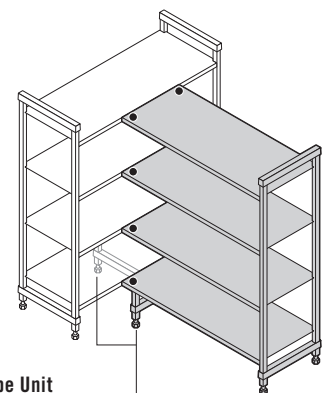

T-Shape Unit
Starter unit + Add-on unit using 1 set of corner connectors per shelf and 2 dunnage stands.

Corner Connectors ● = Corner Connectors

Convert unusable space into continuous, easy-access storage areas using corner connectors. (Corner connectors are for use only with shelves 24" - 48" long.)

Camshelving is covered under the following US Patents:

D498,664 S, D508,646 S, D512,867 S, D623,929 S, D624,764 S, D648,582 S, D630,935 S, D648,159 S, D651,433 S, D648,160 S, D697,391 S, D727,715 S, D728,347 S, D728,348 S, D707,994 S, D739,989 S, D663,912 S, D736,488 S, D739,989 S, US 6,981,454B2, D760,519 S.

CAMSHELVING® SERIES BUYERS GUIDE

All Camshelving lines offer a lifetime warranty against rust and corrosion for shelf plates, posts and traverses.



	PREMIUM series	ELEMENTS series	BASICS PLUS series
Shelf Depths	14", 18", 21", 24"	14", 18", 21", 24"	18", 21", 24"
Shelf Lengths	24", 30", 36", 42", 48", 54", 60", 72"	24", 30", 36", 42", 48", 54", 60", 72"	30", 36", 42", 48", 54", 60"
Post Heights	Stationary: 32", 56", 64", 72", 84" Mobile: 35", 59", 67", 75" (includes casters)	Stationary: 30", 64", 72", 84" Mobile: 27¼", 70¼", 78¼" (includes casters)	Stationary: 64", 72", 84"
Weight-Bearing Capacity (based on 24" - 48" length)	Stationary Unit: 800 lbs. per shelf, 2000 lbs. per unit. Mobile Unit: 750 lbs. per unit. Corner Unit: 400 lbs. per shelf, 1800 lbs. per unit.	Stationary Unit: 800 lbs. per shelf, 2000 lbs. per unit. Mobile Unit: 750 lbs. per unit. Corner Unit: 400 lbs. per shelf, 1800 lbs. per unit.	Stationary Unit: 700 lbs. per shelf, 1800 lbs. per unit. Corner Unit: 300 lbs. per shelf, 1350 lbs. per unit.
Shelf Plates	Interchangeable with Elements Series. Features Camguard® antimicrobial.	Interchangeable with Premium Series. Features Camguard antimicrobial.	Not interchangeable with Premium or Elements Series. Features Camguard antimicrobial.
Mobility	Available in Mobile and High Density Storage System.	Available in Mobile.	Not available.
Assembly	Quickest and easiest to assemble due to molded-in dovetails.	Simple to assemble. Contains separate dovetails that must be attached to the post.	Simple to assemble. Contains separate dovetails that must be attached to the post.
ACCESSORIES			
Bottom Shelf Dunnage Stand	✓	✓	✓
Shelf Rails	✓	✓	✓
Vertical Drying and Storage Cradle (Trays / Cutting Boards / Lids)	✓	✓	✓
Dome Drying and Storage Cradle	✓	✓	✓
Angled Drying and Storage Cradle	✓	✓	✓
Ultimate #10 Can Rack	✓	✓	
Shelf Divider Panel	✓	✓	✓
Shelf Divider Bar (for Food Pans or Food Boxes)	✓	✓	
Single Shelf Sheet Pan/Tray Rack	✓	✓	✓
Single Shelf Security Cage	✓	✓	✓
Full Wrap Security Cage	✓		
Pegboard and Hooks	✓	✓	✓

CAMSHELVING® SERIES OVERALL LENGTH QUICK REFERENCE GUIDE

Straight Unit: Starter Unit + Add-On Unit with Shared Posts

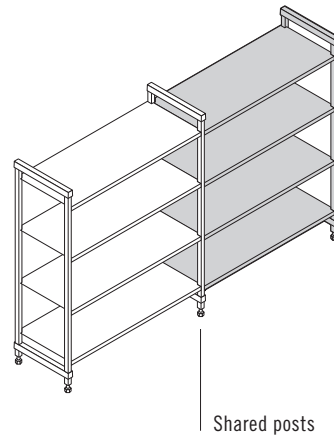
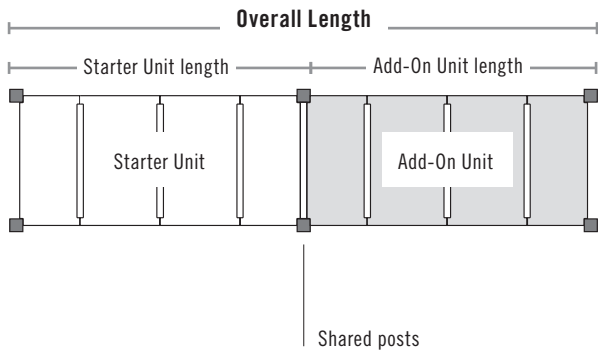

Corner Unit: Starter Unit + Add-On Unit with Corner Connectors

• = Corner Connectors

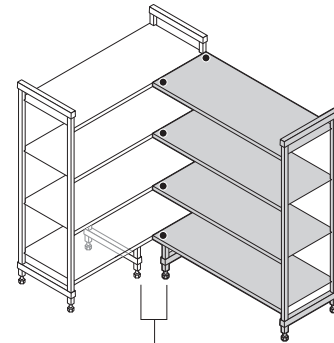
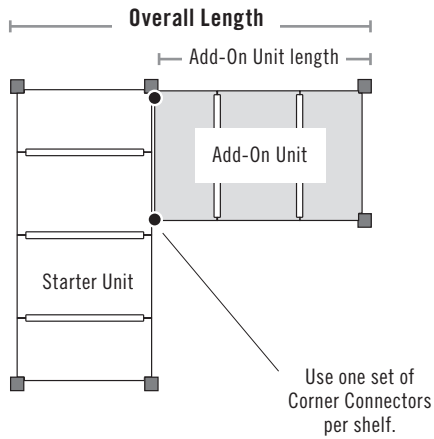

Use One Dunnage Stand under each Starter and Add-On Unit.

Corner Connectors are for use only with shelves 24" - 48" long.

U-Shape Unit: Two Starter Units + Intermediate Shelves with Corner Connectors

• = Corner Connectors

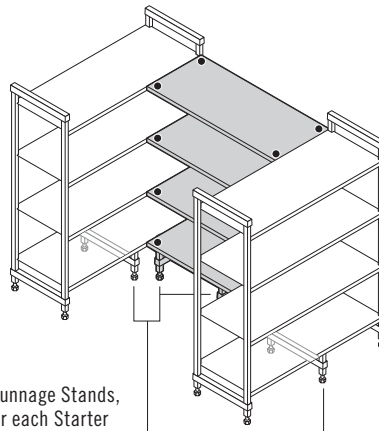
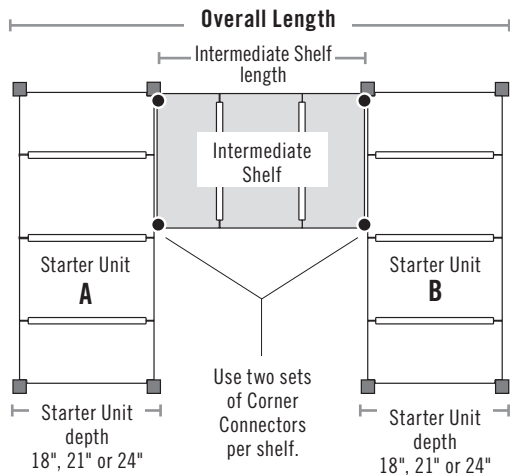

Use four Dunnage Stands, one under each Starter Unit and two under the bottom Intermediate Shelf.

Straight Unit: Starter Unit + Add-On Unit with Shared Posts

PREMIUM® / BASICS PLUS® SERIES				
STARTER & ADD-ON UNIT	STARTER UNIT ACTUAL LENGTH		ADD-ON UNIT ACTUAL LENGTH	OVERALL LENGTH
24"	24"	+	22¼"	= 46¼"
30"	30"	+	28¼"	= 58¼"
36"	36"	+	34¼"	= 70¼"
42"	42"	+	40¼"	= 82¼"
48"	48"	+	46¼"	= 94¼"
54"	54"	+	52¼"	= 106¼"
60"	60"	+	58¼"	= 118¼"
72"	72"	+	70¼"	= 142¼"

24" and 72" are not available in Camshelving Basics Plus Series.

ELEMENTS® SERIES				
STARTER UNIT ACTUAL LENGTH		ADD-ON UNIT ACTUAL LENGTH		OVERALL LENGTH
24"	+	22"	=	46"
30"	+	28"	=	58"
36"	+	34"	=	70"
42"	+	40"	=	82"
48"	+	46"	=	94"
54"	+	52"	=	106"
60"	+	58"	=	118"
72"	+	70"	=	142"

Corner Unit: Starter Unit + Add-On Unit with Corner Connectors

PREMIUM / ELEMENTS / BASICS PLUS SERIES				
ADD-ON UNIT	ADD-ON UNIT ACTUAL LENGTH		18" STARTER UNIT DEPTH	OVERALL LENGTH
24"	23"	+	18"	= 41"
30"	29"	+	18"	= 47"
36"	35"	+	18"	= 53"
42"	41"	+	18"	= 59"
48"	47"	+	18"	= 65"

24" unit not available in Camshelving Basics Plus Series.

PREMIUM / ELEMENTS / BASICS PLUS SERIES				
ADD-ON UNIT ACTUAL LENGTH		21" STARTER UNIT DEPTH		OVERALL LENGTH
23"	+	21"	=	44"
29"	+	21"	=	50"
35"	+	21"	=	56"
41"	+	21"	=	62"
47"	+	21"	=	68"

PREMIUM / ELEMENTS / BASICS PLUS SERIES				
ADD-ON UNIT ACTUAL LENGTH		24" STARTER UNIT DEPTH		OVERALL LENGTH
23"	+	24"	=	47"
29"	+	24"	=	53"
35"	+	24"	=	59"
41"	+	24"	=	65"
47"	+	24"	=	71"

U-Shape Unit: Two Starter Units + Intermediate Shelves with Corner Connectors

PREMIUM / ELEMENTS / BASICS PLUS SERIES				
INTERMEDIATE SHELF	INTERMEDIATE SHELF ACTUAL LENGTH		18" DEPTH STARTER UNIT A+B	OVERALL LENGTH
36"	34"	+	36"	= 70"
42"	40"	+	36"	= 76"
48"	46"	+	36"	= 82"

PREMIUM / ELEMENTS / BASICS PLUS SERIES				
INTERMEDIATE SHELF ACTUAL LENGTH		21" DEPTH STARTER UNIT A+B		OVERALL LENGTH
34"	+	42"	=	76"
40"	+	42"	=	82"
46"	+	42"	=	88"

PREMIUM / ELEMENTS / BASICS PLUS SERIES				
INTERMEDIATE SHELF ACTUAL LENGTH		24" DEPTH STARTER UNIT A+B		OVERALL LENGTH
34"	+	48"	=	82"
40"	+	48"	=	88"
46"	+	48"	=	94"

CAMSHELVING PREMIUM® AND ELEMENTS® SERIES SPACE REFERENCE GUIDE

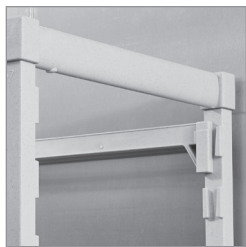
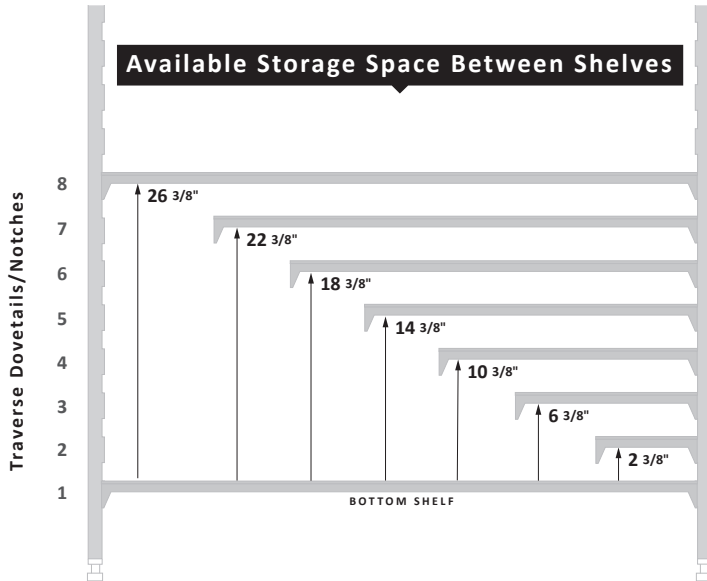
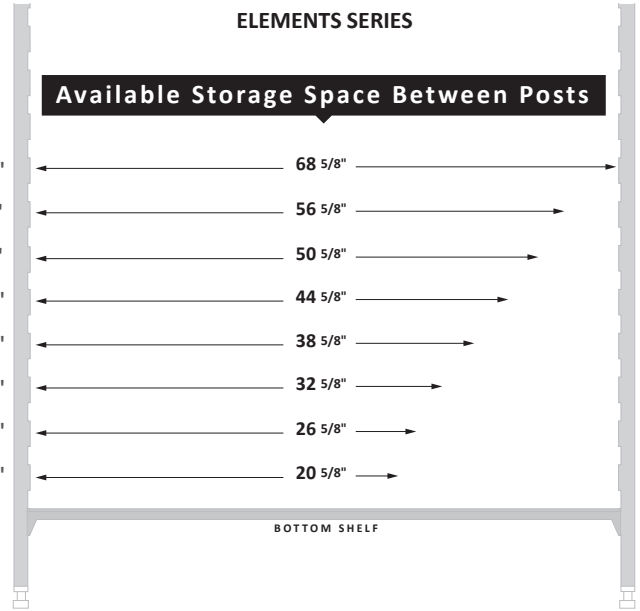
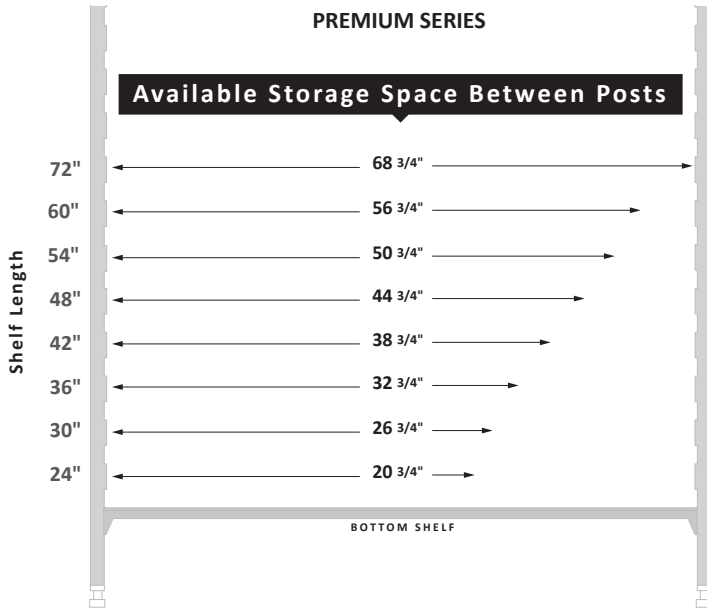

Traverse Dovetails

POST HEIGHT	NUMBER OF DOVETAILS PER POST*
STATIONARY UNIT	
30"	5
32"	6
56"	12
64"	14
72"	16
84"	19
MOBILE UNIT	
27 1/4"	3
35"	6
59"	12
67" or 70 1/4"	14
75" or 78 1/4"	16

*Also equals maximum number of shelves per unit.



CAMSHELVING BASICS® PLUS SERIES SPACE REFERENCE GUIDE

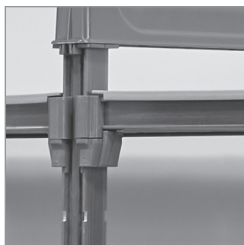
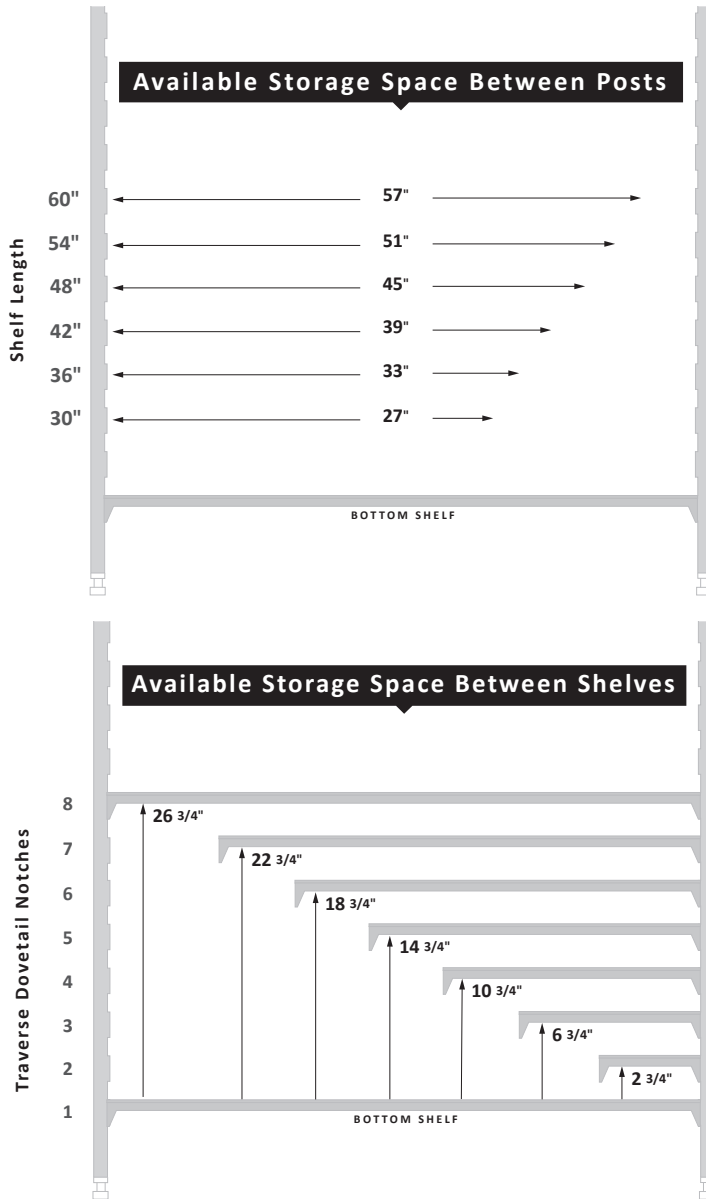

Traverse Dovetails

POST HEIGHT	NUMBER OF DOVETAILS PER POST*
64"	14
72"	16
84"	19

*Also equals maximum number of shelves per unit.

CAMSHELVING

PREMIUM[®]

series

STATIONARY | MOBILE | HIGH DENSITY

WHY CHOOSE PREMIUM?

In high volume foodservice operations with frequent deliveries and constant loading and off-loading of products, stability, strength and sanitary storage should never be compromised. Premium Series does precisely what it was designed to do – hold the heaviest products with the roughest handling, in any environment. It is also the easiest to clean and adjust.

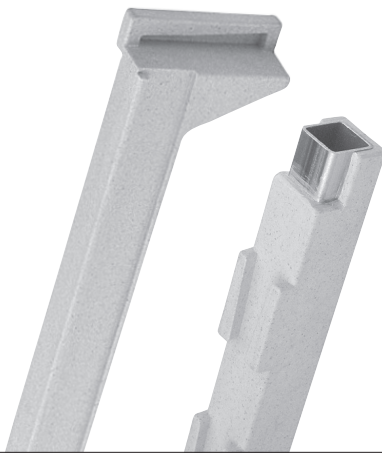

camguard.

ANTIMICROBIAL SHELF PLATES



**StoreSafe
StaySafe**

Post Connectors, Corner Connectors, Floor Fastener, Wall Fastener, Identification Tags, Full Wrap Security Cage, Single Shelf Security Cage, Ultimate #10 Can Rack, Shelf Rails, Shelf Divider Bars, Flex Station Merchandisers, High Density Track and Extension Kits are not NSF Listed.

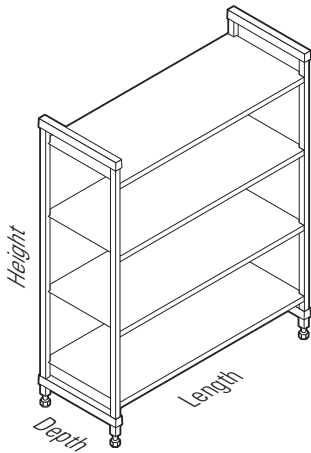

Stationary Unit Sizes

4 Depths		
14"	18"	21"
24"		
8 Lengths		
24"	30"	36"
42"	48"	54"
60"	72"	
5 Heights		
32"	56"	64"
72"	84"	

Mobile Unit Sizes

3 Depths		
18"	21"	24"
3 Lengths		
36"	42"	48"
4 Heights		
35"	59"	67"
75"		

High Density Unit Sizes

3 Depths		
18"	21"	24"
5 Lengths		
36"	42"	48"
54"	60"	
2 Heights		
67"	75"	

Weight Bearing Capacity

Weight must be evenly distributed across the entire shelf.

		UNIT LENGTH 24" – 48"	UNIT LENGTH 54" – 72"
SINGLE UNIT	Unit only	2,000 lbs.	2,000 lbs.
	Shelf only	800	600
	Unit with dunnage stand*	2,400	2,300
	Bottom shelf with dunnage stand*	1,200	900
CORNER UNIT*** With 2 Dunnage Stands required	Unit only	1,800	—
	Shelf only	400	—
	Bottom shelf with dunnage stands*	600	—
MOBILE UNIT	Unit only**	750	750

*Dunnage Stands add stability and increase weight bearing capacity on bottom shelf only. Highly recommended for Starter Units 54" and longer, all Corner Units, U-Shape Units and units specified for heavier loads. (See Overall Length Quick Reference Guide).

**Due to the weight bearing capacity of casters, maximum weight load on an entire Mobile Unit (Standard Mobile or High Density) is 750 lbs.

***Corner connectors are for use only with shelves 24" - 48" long.



CAMSHELVING PREMIUM® SERIES – STARTER, ADD-ON AND MOBILE UNITS

V4 4-Shelf Vented Stationary Starter and Add-On Units

HEIGHTS	DEPTHS	LENGTHS
3	3	8
64"	18"	24" 48"
72"	21"	30" 54"
84"	24"	36" 60"
		42" 72"

V5 5-Shelf Vented Stationary Starter and Add-On Units

HEIGHTS	DEPTHS	LENGTHS
3	3	8
64"	18"	24" 48"
72"	21"	30" 54"
84"	24"	36" 60"
		42" 72"

S4 4-Shelf Solid Stationary Starter and Add-On Units

HEIGHTS	DEPTHS	LENGTHS
3	3	8
64"	18"	24" 48"
72"	21"	30" 54"
84"	24"	36" 60"
		42" 72"

S5 5-Shelf Solid Stationary Starter and Add-On Units

HEIGHT	DEPTHS	LENGTHS
1	3	8
84"	18"	24" 48"
	21"	30" 54"
	24"	36" 60"
		42" 72"

VS4 4-Shelf Vented and Solid Stationary Starter and Add-On Units (3 vented + 1 solid)

HEIGHTS	DEPTHS	LENGTHS
3	3	8
64"	18"	24" 48"
72"	21"	30" 54"
84"	24"	36" 60"
		42" 72"

VS5 5-Shelf Vented and Solid Stationary Starter and Add-On Units (4 vented + 1 solid)

HEIGHT	DEPTHS	LENGTHS
1	3	8
84"	18"	24" 48"
	21"	30" 54"
	24"	36" 60"
		42" 72"

V4 4-Shelf Vented Mobile Starter Units

HEIGHTS*	DEPTHS	LENGTHS
2	3	3
67"	18"	36"
75"	21"	42"
	24"	48"

*Includes 5" casters.

V5 5-Shelf Vented Mobile Starter Units

HEIGHTS*	DEPTHS	LENGTHS
2	3	3
67"	18"	36"
75"	21"	42"
	24"	48"

*Includes 5" casters.

V4

4-Shelf Vented Stationary Starter and Add-On Units

V5

5-Shelf Vented Stationary Starter and Add-On Units

Units ship complete in 1 box and include 1 or 2 factory assembled post kits, traverses and shelf plates.

NOTE: Due to unit weight, units 72" long and/or 84" high, ship in 2 or 3 separate boxes with 1 or 2 unassembled post kits and 1 box of 4 or 5 shelves. These products are identified with PKG in the code.

64"
HEIGHT

18"
DEPTH

Starter

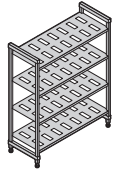

Add-On

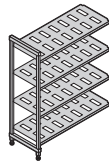

LENGTH	CODE	LIST PRICE EA.
24"	CPU182464V4	\$ 540.00
30"	CPU183064V4	610.00
36"	CPU183664V4	650.00
42"	CPU184264V4	725.00
48"	CPU184864V4	755.00
54"	CPU185464V4	835.00
60"	CPU186064V4	885.00
72"	CPU187264V4PKG	990.00

LENGTH	CODE	LIST PRICE EA.
22¼"	CPA182464V4	\$ 415.00
28¾"	CPA183064V4	490.00
34¼"	CPA183664V4	525.00
40¼"	CPA184264V4	605.00
46¼"	CPA184864V4	635.00
52¼"	CPA185464V4	710.00
58¼"	CPA186064V4	765.00
70¼"	CPA187264V4PKG	870.00

21"
DEPTH

24"	CPU212464V4	\$ 580.00
30"	CPU213064V4	660.00
36"	CPU213664V4	705.00
42"	CPU214264V4	795.00
48"	CPU214864V4	830.00
54"	CPU215464V4	920.00
60"	CPU216064V4	980.00
72"	CPU217264V4PKG	1,100.00

22¼"	CPA212464V4	\$ 455.00
28¾"	CPA213064V4	535.00
34¼"	CPA213664V4	585.00
40¼"	CPA214264V4	670.00
46¼"	CPA214864V4	705.00
52¼"	CPA215464V4	795.00
58¼"	CPA216064V4	855.00
70¼"	CPA217264V4PKG	980.00

24"
DEPTH

24"	CPU242464V4	\$ 590.00
30"	CPU243064V4	675.00
36"	CPU243664V4	725.00
42"	CPU244264V4	805.00
48"	CPU244864V4	860.00
54"	CPU245464V4	930.00
60"	CPU246064V4	985.00
72"	CPU247264V4PKG	1,120.00

22¼"	CPA242464V4	\$ 465.00
28¾"	CPA243064V4	550.00
34¼"	CPA243664V4	600.00
40¼"	CPA244264V4	680.00
46¼"	CPA244864V4	735.00
52¼"	CPA245464V4	805.00
58¼"	CPA246064V4	860.00
70¼"	CPA247264V4PKG	995.00

Starter

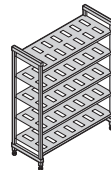

Add-On

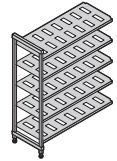

LENGTH	CODE	LIST PRICE EA.
24"	CPU182464V5	\$ 610.00
30"	CPU183064V5	700.00
36"	CPU183664V5	750.00
42"	CPU184264V5	850.00
48"	CPU184864V5	885.00
54"	CPU185464V5	980.00
60"	CPU186064V5	1,050.00
72"	CPU187264V5PKG	1,180.00

LENGTH	CODE	LIST PRICE EA.
22¼"	CPA182464V5	\$ 490.00
28¾"	CPA183064V5	580.00
34¼"	CPA183664V5	630.00
40¼"	CPA184264V5	725.00
46¼"	CPA184864V5	760.00
52¼"	CPA185464V5	860.00
58¼"	CPA186064V5	925.00
70¼"	CPA187264V5PKG	1,060.00

24"	CPU212464V5	\$ 665.00
30"	CPU213064V5	765.00
36"	CPU213664V5	820.00
42"	CPU214264V5	935.00
48"	CPU214864V5	975.00
54"	CPU215464V5	1,085.00
60"	CPU216064V5	1,165.00
72"	CPU217264V5PKG	1,315.00

22¼"	CPA212464V5	\$ 540.00
28¾"	CPA213064V5	640.00
34¼"	CPA213664V5	695.00
40¼"	CPA214264V5	810.00
46¼"	CPA214864V5	850.00
52¼"	CPA215464V5	965.00
58¼"	CPA216064V5	1,040.00
70¼"	CPA217264V5PKG	1,190.00

24"	CPU242464V5	\$ 675.00
30"	CPU243064V5	780.00
36"	CPU243664V5	845.00
42"	CPU244264V5	945.00
48"	CPU244864V5	1,010.00
54"	CPU245464V5	1,105.00
60"	CPU246064V5	1,170.00
72"	CPU247264V5PKG	1,335.00

22¼"	CPA242464V5	\$ 550.00
28¾"	CPA243064V5	655.00
34¼"	CPA243664V5	720.00
40¼"	CPA244264V5	820.00
46¼"	CPA244864V5	885.00
52¼"	CPA245464V5	980.00
58¼"	CPA246064V5	1,045.00
70¼"	CPA247264V5PKG	1,210.00

Color: Speckled Gray (480).

S4

4-Shelf Solid Stationary Starter and Add-On Units

VS4

4-Shelf Vented and Solid Stationary Starter and Add-On Units

(3 Vented + 1 Solid)

Units ship complete in 1 box and include 1 or 2 factory assembled post kits, traverses and shelf plates.

NOTE: Due to unit weight, units 72" long and/or 84" high, ship in 2 or 3 separate boxes with 1 or 2 unassembled post kits and 1 box of 4 or 5 shelves. These products are identified with PKG in the code.

64"
HEIGHT

Starter

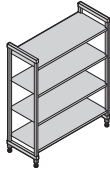

Add-On

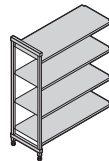

18"
DEPTH

LENGTH	CODE	LIST PRICE EA.
24"	CPU182464S4	\$ 555.00
30"	CPU183064S4	625.00
36"	CPU183664S4	665.00
42"	CPU184264S4	750.00
48"	CPU184864S4	780.00
54"	CPU185464S4	860.00
60"	CPU186064S4	920.00
72"	CPU187264S4PKG	1,030.00

LENGTH	CODE	LIST PRICE EA.
22¼"	CPA182464S4	\$ 430.00
28¾"	CPA183064S4	505.00
34¼"	CPA183664S4	545.00
40¼"	CPA184264S4	630.00
46¼"	CPA184864S4	655.00
52¼"	CPA185464S4	740.00
58¼"	CPA186064S4	800.00
70¼"	CPA187264S4PKG	910.00

Starter

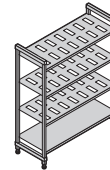

Add-On

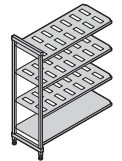

LENGTH	CODE	LIST PRICE EA.
24"	CPU182464VS4	\$ 540.00
30"	CPU183064VS4	615.00
36"	CPU183664VS4	655.00
42"	CPU184264VS4	735.00
48"	CPU184864VS4	760.00
54"	CPU185464VS4	840.00
60"	CPU186064VS4	895.00
72"	CPU187264VS4PKG	1,000.00

LENGTH	CODE	LIST PRICE EA.
22¼"	CPA182464VS4	\$ 420.00
28¾"	CPA183064VS4	490.00
34¼"	CPA183664VS4	530.00
40¼"	CPA184264VS4	610.00
46¼"	CPA184864VS4	640.00
52¼"	CPA185464VS4	720.00
58¼"	CPA186064VS4	775.00
70¼"	CPA187264VS4PKG	880.00

21"
DEPTH

24"	CPU212464S4	\$ 595.00
30"	CPU213064S4	680.00
36"	CPU213664S4	730.00
42"	CPU214264S4	825.00
48"	CPU214864S4	865.00
54"	CPU215464S4	955.00
60"	CPU216064S4	1,020.00
72"	CPU217264S4PKG	1,155.00

22¼"	CPA212464S4	\$ 470.00
28¾"	CPA213064S4	555.00
34¼"	CPA213664S4	610.00
40¼"	CPA214264S4	700.00
46¼"	CPA214864S4	740.00
52¼"	CPA215464S4	835.00
58¼"	CPA216064S4	895.00
70¼"	CPA217264S4PKG	1,030.00

24"	CPU212464VS4	\$ 585.00
30"	CPU213064VS4	665.00
36"	CPU213664VS4	715.00
42"	CPU214264VS4	805.00
48"	CPU214864VS4	840.00
54"	CPU215464VS4	930.00
60"	CPU216064VS4	990.00
72"	CPU217264VS4PKG	1,115.00

22¼"	CPA212464VS4	\$ 460.00
28¾"	CPA213064VS4	540.00
34¼"	CPA213664VS4	590.00
40¼"	CPA214264VS4	680.00
46¼"	CPA214864VS4	715.00
52¼"	CPA215464VS4	805.00
58¼"	CPA216064VS4	865.00
70¼"	CPA217264VS4PKG	990.00

24"
DEPTH

24"	CPU242464S4	\$ 620.00
30"	CPU243064S4	705.00
36"	CPU243664S4	760.00
42"	CPU244264S4	840.00
48"	CPU244864S4	895.00
54"	CPU245464S4	980.00
60"	CPU246064S4	1,040.00
72"	CPU247264S4PKG	1,175.00

22¼"	CPA242464S4	\$ 495.00
28¾"	CPA243064S4	580.00
34¼"	CPA243664S4	635.00
40¼"	CPA244264S4	715.00
46¼"	CPA244864S4	770.00
52¼"	CPA245464S4	855.00
58¼"	CPA246064S4	915.00
70¼"	CPA247264S4PKG	1,050.00

24"	CPU242464VS4	\$ 595.00
30"	CPU243064VS4	680.00
36"	CPU243664VS4	735.00
42"	CPU244264VS4	815.00
48"	CPU244864VS4	870.00
54"	CPU245464VS4	945.00
60"	CPU246064VS4	1,000.00
72"	CPU247264VS4PKG	1,135.00

22¼"	CPA242464VS4	\$ 470.00
28¾"	CPA243064VS4	555.00
34¼"	CPA243664VS4	610.00
40¼"	CPA244264VS4	690.00
46¼"	CPA244864VS4	745.00
52¼"	CPA245464VS4	820.00
58¼"	CPA246064VS4	875.00
70¼"	CPA247264VS4PKG	1,010.00

Color: Speckled Gray (480).

V4

4-Shelf Vented Stationary Starter and Add-On Units

V5

5-Shelf Vented Stationary Starter and Add-On Units

Units ship complete in 1 box and include 1 or 2 factory assembled post kits, traverses and shelf plates.

NOTE: Due to unit weight, units 72" long and/or 84" high, ship in 2 or 3 separate boxes with 1 or 2 unassembled post kits and 1 box of 4 or 5 shelves. These products are identified with PKG in the code.

72"
HEIGHT

18"
DEPTH

Starter

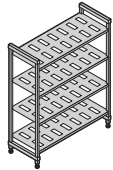

Add-On

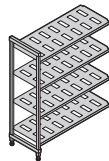

LENGTH	CODE	LIST PRICE EA.
24"	CPU182472V4	\$ 545.00
30"	CPU183072V4	615.00
36"	CPU183672V4	655.00
42"	CPU184272V4	730.00
48"	CPU184872V4	760.00
54"	CPU185472V4	840.00
60"	CPU186072V4	890.00
72"	CPU187272V4PKG	995.00

LENGTH	CODE	LIST PRICE EA.
22¼"	CPA182472V4	\$ 420.00
28¼"	CPA183072V4	490.00
34¼"	CPA183672V4	530.00
40¼"	CPA184272V4	610.00
46¼"	CPA184872V4	635.00
52¼"	CPA185472V4	715.00
58¼"	CPA186072V4	770.00
70¼"	CPA187272V4PKG	875.00

Starter

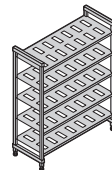

Add-On

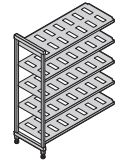

LENGTH	CODE	LIST PRICE EA.
24"	CPU182472V5	\$ 620.00
30"	CPU183072V5	705.00
36"	CPU183672V5	755.00
42"	CPU184272V5	855.00
48"	CPU184872V5	890.00
54"	CPU185472V5	985.00
60"	CPU186072V5	1,055.00
72"	CPU187272V5PKG	1,185.00

LENGTH	CODE	LIST PRICE EA.
22¼"	CPA182472V5	\$ 495.00
28¼"	CPA183072V5	580.00
34¼"	CPA183672V5	630.00
40¼"	CPA184272V5	730.00
46¼"	CPA184872V5	765.00
52¼"	CPA185472V5	865.00
58¼"	CPA186072V5	930.00
70¼"	CPA187272V5PKG	1,060.00

21"
DEPTH

24"	CPU212472V4	\$ 585.00
30"	CPU213072V4	665.00
36"	CPU213672V4	710.00
42"	CPU214272V4	800.00
48"	CPU214872V4	835.00
54"	CPU215472V4	925.00
60"	CPU216072V4	985.00
72"	CPU217272V4PKG	1,105.00

22¼"	CPA212472V4	\$ 460.00
28¼"	CPA213072V4	540.00
34¼"	CPA213672V4	585.00
40¼"	CPA214272V4	675.00
46¼"	CPA214872V4	710.00
52¼"	CPA215472V4	800.00
58¼"	CPA216072V4	860.00
70¼"	CPA217272V4PKG	980.00

24"	CPU212472V5	\$ 670.00
30"	CPU213072V5	770.00
36"	CPU213672V5	825.00
42"	CPU214272V5	940.00
48"	CPU214872V5	980.00
54"	CPU215472V5	1,090.00
60"	CPU216072V5	1,170.00
72"	CPU217272V5PKG	1,320.00

22¼"	CPA212472V5	\$ 540.00
28¼"	CPA213072V5	640.00
34¼"	CPA213672V5	700.00
40¼"	CPA214272V5	810.00
46¼"	CPA214872V5	855.00
52¼"	CPA215472V5	965.00
58¼"	CPA216072V5	1,040.00
70¼"	CPA217272V5PKG	1,195.00

24"
DEPTH

24"	CPU242472V4	\$ 595.00
30"	CPU243072V4	680.00
36"	CPU243672V4	730.00
42"	CPU244272V4	810.00
48"	CPU244872V4	865.00
54"	CPU245472V4	940.00
60"	CPU246072V4	995.00
72"	CPU247272V4PKG	1,125.00

22¼"	CPA242472V4	\$ 470.00
28¼"	CPA243072V4	550.00
34¼"	CPA243672V4	605.00
40¼"	CPA244272V4	685.00
46¼"	CPA244872V4	735.00
52¼"	CPA245472V4	810.00
58¼"	CPA246072V4	865.00
70¼"	CPA247272V4PKG	995.00

24"	CPU242472V5	\$ 680.00
30"	CPU243072V5	785.00
36"	CPU243672V5	850.00
42"	CPU244272V5	950.00
48"	CPU244872V5	1,015.00
54"	CPU245472V5	1,110.00
60"	CPU246072V5	1,175.00
72"	CPU247272V5PKG	1,340.00

22¼"	CPA242472V5	\$ 555.00
28¼"	CPA243072V5	655.00
34¼"	CPA243672V5	725.00
40¼"	CPA244272V5	820.00
46¼"	CPA244872V5	890.00
52¼"	CPA245472V5	980.00
58¼"	CPA246072V5	1,050.00
70¼"	CPA247272V5PKG	1,215.00

Color: Speckled Gray (480).

S4

4-Shelf Solid Stationary Starter and Add-On Units

VS4

4-Shelf Vented and Solid Stationary Starter and Add-On Units

(3 Vented + 1 Solid)

Units ship complete in 1 box and include 1 or 2 factory assembled post kits, traverses and shelf plates.

NOTE: Due to unit weight, units 72" long and/or 84" high, ship in 2 or 3 separate boxes with 1 or 2 unassembled post kits and 1 box of 4 or 5 shelves. These products are identified with PKG in the code.

72"
HEIGHT

Starter

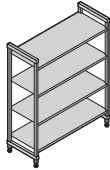

Add-On

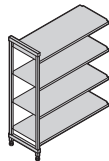

18"
DEPTH

LENGTH	CODE	LIST PRICE EA.
24"	CPU182472S4	\$ 560.00
30"	CPU183072S4	630.00
36"	CPU183672S4	675.00
42"	CPU184272S4	755.00
48"	CPU184872S4	785.00
54"	CPU185472S4	870.00
60"	CPU186072S4	925.00
72"	CPU187272S4PKG	1,035.00

LENGTH	CODE	LIST PRICE EA.
22¼"	CPA182472S4	\$ 435.00
28¾"	CPA183072S4	505.00
34¼"	CPA183672S4	550.00
40¼"	CPA184272S4	635.00
46¼"	CPA184872S4	660.00
52¼"	CPA185472S4	745.00
58¼"	CPA186072S4	805.00
70¼"	CPA187272S4PKG	910.00

Starter

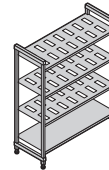

Add-On

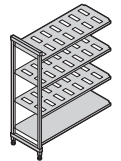

LENGTH	CODE	LIST PRICE EA.
24"	CPU182472VS4	\$ 545.00
30"	CPU183072VS4	620.00
36"	CPU183672VS4	660.00
42"	CPU184272VS4	740.00
48"	CPU184872VS4	765.00
54"	CPU185472VS4	845.00
60"	CPU186072VS4	900.00
72"	CPU187272VS4PKG	1,005.00

LENGTH	CODE	LIST PRICE EA.
22¼"	CPA182472VS4	\$ 425.00
28¾"	CPA183072VS4	495.00
34¼"	CPA183672VS4	535.00
40¼"	CPA184272VS4	615.00
46¼"	CPA184872VS4	640.00
52¼"	CPA185472VS4	720.00
58¼"	CPA186072VS4	775.00
70¼"	CPA187272VS4PKG	885.00

21"
DEPTH

24"	CPU212472S4	\$ 600.00
30"	CPU213072S4	685.00
36"	CPU213672S4	735.00
42"	CPU214272S4	830.00
48"	CPU214872S4	870.00
54"	CPU215472S4	960.00
60"	CPU216072S4	1,025.00
72"	CPU217272S4PKG	1,160.00

22¼"	CPA212472S4	\$ 470.00
28¾"	CPA213072S4	560.00
34¼"	CPA213672S4	610.00
40¼"	CPA214272S4	700.00
46¼"	CPA214872S4	745.00
52¼"	CPA215472S4	835.00
58¼"	CPA216072S4	900.00
70¼"	CPA217272S4PKG	1,030.00

24"	CPU212472VS4	\$ 590.00
30"	CPU213072VS4	670.00
36"	CPU213672VS4	720.00
42"	CPU214272VS4	810.00
48"	CPU214872VS4	845.00
54"	CPU215472VS4	935.00
60"	CPU216072VS4	995.00
72"	CPU217272VS4PKG	1,120.00

22¼"	CPA212472VS4	\$ 460.00
28¾"	CPA213072VS4	545.00
34¼"	CPA213672VS4	590.00
40¼"	CPA214272VS4	680.00
46¼"	CPA214872VS4	720.00
52¼"	CPA215472VS4	805.00
58¼"	CPA216072VS4	870.00
70¼"	CPA217272VS4PKG	995.00

24"
DEPTH

24"	CPU242472S4	\$ 625.00
30"	CPU243072S4	710.00
36"	CPU243672S4	765.00
42"	CPU244272S4	845.00
48"	CPU244872S4	905.00
54"	CPU245472S4	985.00
60"	CPU246072S4	1,045.00
72"	CPU247272S4PKG	1,180.00

22¼"	CPA242472S4	\$ 495.00
28¾"	CPA243072S4	580.00
34¼"	CPA243672S4	640.00
40¼"	CPA244272S4	720.00
46¼"	CPA244872S4	775.00
52¼"	CPA245472S4	855.00
58¼"	CPA246072S4	920.00
70¼"	CPA247272S4PKG	1,055.00

24"	CPU242472VS4	\$ 600.00
30"	CPU243072VS4	685.00
36"	CPU243672VS4	740.00
42"	CPU244272VS4	820.00
48"	CPU244872VS4	875.00
54"	CPU245472VS4	950.00
60"	CPU246072VS4	1,005.00
72"	CPU247272VS4PKG	1,140.00

22¼"	CPA242472VS4	\$ 475.00
28¾"	CPA243072VS4	560.00
34¼"	CPA243672VS4	610.00
40¼"	CPA244272VS4	690.00
46¼"	CPA244872VS4	745.00
52¼"	CPA245472VS4	820.00
58¼"	CPA246072VS4	880.00
70¼"	CPA247272VS4PKG	1,010.00

Color: Speckled Gray (480).

V4PKG

4-Shelf Vented Stationary Starter and Add-On Units

V5PKG

5-Shelf Vented Stationary Starter and Add-On Units

Units ship in 2 or 3 separate boxes with 1 or 2 unassembled post kits and 1 box of 4 or 5 shelves.

84"
HEIGHT

18"
DEPTH

Starter

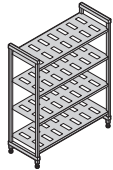

Add-On

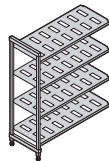

LENGTH	CODE	LIST PRICE EA.
24"	CPU182484V4PKG	\$ 580.00
30"	CPU183084V4PKG	650.00
36"	CPU183684V4PKG	690.00
42"	CPU184284V4PKG	770.00
48"	CPU184884V4PKG	800.00
54"	CPU185484V4PKG	875.00
60"	CPU186084V4PKG	930.00
72"	CPU187284V4PKG	1,035.00

LENGTH	CODE	LIST PRICE EA.
22¼"	CPA182484V4PKG	\$ 440.00
28¼"	CPA183084V4PKG	510.00
34¼"	CPA183684V4PKG	550.00
40¼"	CPA184284V4PKG	630.00
46¼"	CPA184884V4PKG	655.00
52¼"	CPA185484V4PKG	735.00
58¼"	CPA186084V4PKG	790.00
70¼"	CPA187284V4PKG	890.00

Starter

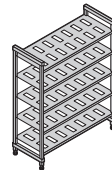

Add-On

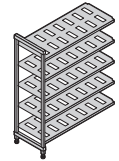

LENGTH	CODE	LIST PRICE EA.
24"	CPU182484V5PKG	\$ 655.00
30"	CPU183084V5PKG	745.00
36"	CPU183684V5PKG	795.00
42"	CPU184284V5PKG	890.00
48"	CPU184884V5PKG	925.00
54"	CPU185484V5PKG	1,025.00
60"	CPU186084V5PKG	1,090.00
72"	CPU187284V5PKG	1,225.00

LENGTH	CODE	LIST PRICE EA.
22¼"	CPA182484V5PKG	\$ 515.00
28¼"	CPA183084V5PKG	600.00
34¼"	CPA183684V5PKG	650.00
40¼"	CPA184284V5PKG	750.00
46¼"	CPA184884V5PKG	785.00
52¼"	CPA185484V5PKG	880.00
58¼"	CPA186084V5PKG	950.00
70¼"	CPA187284V5PKG	1,080.00

21"
DEPTH

24"	CPU212484V4PKG	\$ 625.00
30"	CPU213084V4PKG	705.00
36"	CPU213684V4PKG	750.00
42"	CPU214284V4PKG	840.00
48"	CPU214884V4PKG	875.00
54"	CPU215484V4PKG	965.00
60"	CPU216084V4PKG	1,025.00
72"	CPU217284V4PKG	1,145.00

22¼"	CPA212484V4PKG	\$ 480.00
28¼"	CPA213084V4PKG	555.00
34¼"	CPA213684V4PKG	625.00
40¼"	CPA214284V4PKG	695.00
46¼"	CPA214884V4PKG	730.00
52¼"	CPA215484V4PKG	815.00
58¼"	CPA216084V4PKG	880.00
70¼"	CPA217284V4PKG	1,000.00

24"	CPU212484V5PKG	\$ 705.00
30"	CPU213084V5PKG	805.00
36"	CPU213684V5PKG	865.00
42"	CPU214284V5PKG	975.00
48"	CPU214884V5PKG	1,020.00
54"	CPU215484V5PKG	1,130.00
60"	CPU216084V5PKG	1,205.00
72"	CPU217284V5PKG	1,360.00

22¼"	CPA212484V5PKG	\$ 560.00
28¼"	CPA213084V5PKG	660.00
34¼"	CPA213684V5PKG	720.00
40¼"	CPA214284V5PKG	830.00
46¼"	CPA214884V5PKG	875.00
52¼"	CPA215484V5PKG	985.00
58¼"	CPA216084V5PKG	1,060.00
70¼"	CPA217284V5PKG	1,215.00

24"
DEPTH

24"	CPU242484V4PKG	\$ 635.00
30"	CPU243084V4PKG	715.00
36"	CPU243684V4PKG	770.00
42"	CPU244284V4PKG	850.00
48"	CPU244884V4PKG	900.00
54"	CPU245484V4PKG	975.00
60"	CPU246084V4PKG	1,030.00
72"	CPU247284V4PKG	1,160.00

22¼"	CPA242484V4PKG	\$ 485.00
28¼"	CPA243084V4PKG	570.00
34¼"	CPA243684V4PKG	625.00
40¼"	CPA244284V4PKG	700.00
46¼"	CPA244884V4PKG	755.00
52¼"	CPA245484V4PKG	830.00
58¼"	CPA246084V4PKG	885.00
70¼"	CPA247284V4PKG	1,015.00

24"	CPU242484V5PKG	\$ 720.00
30"	CPU243084V5PKG	825.00
36"	CPU243684V5PKG	890.00
42"	CPU244284V5PKG	990.00
48"	CPU244884V5PKG	1,055.00
54"	CPU245484V5PKG	1,145.00
60"	CPU246084V5PKG	1,215.00
72"	CPU247284V5PKG	1,380.00

22¼"	CPA242484V5PKG	\$ 570.00
28¼"	CPA243084V5PKG	675.00
34¼"	CPA243684V5PKG	740.00
40¼"	CPA244284V5PKG	840.00
46¼"	CPA244884V5PKG	905.00
52¼"	CPA245484V5PKG	1,000.00
58¼"	CPA246084V5PKG	1,070.00
70¼"	CPA247284V5PKG	1,230.00

Color: Speckled Gray (480).

S4PKG

4-Shelf Solid Stationary Starter and Add-On Units

S5PKG

5-Shelf Solid Stationary Starter and Add-On Units

Units ship in 2 or 3 separate boxes with 1 or 2 unassembled post kits and
1 box of 4 or 5 shelves.

84"
HEIGHT

Starter

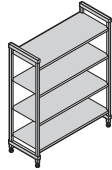

Add-On

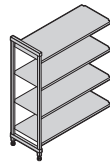

18"
DEPTH

LENGTH	CODE	LIST PRICE EA.
24"	CPU182484S4PKG	\$ 595.00
30"	CPU183084S4PKG	670.00
36"	CPU183684S4PKG	710.00
42"	CPU184284S4PKG	795.00
48"	CPU184884S4PKG	820.00
54"	CPU185484S4PKG	905.00
60"	CPU186084S4PKG	965.00
72"	CPU187284S4PKG	1,075.00

LENGTH	CODE	LIST PRICE EA.
22¼"	CPA182484S4PKG	\$ 455.00
28¾"	CPA183084S4PKG	525.00
34¼"	CPA183684S4PKG	570.00
40¼"	CPA184284S4PKG	650.00
46¼"	CPA184884S4PKG	680.00
52¼"	CPA185484S4PKG	765.00
58¼"	CPA186084S4PKG	820.00
70¼"	CPA187284S4PKG	930.00

Starter

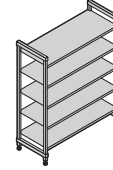

Add-On

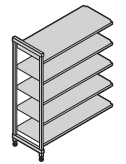

LENGTH	CODE	LIST PRICE EA.
24"	CPU182484S5PKG	\$ 675.00
30"	CPU183084S5PKG	765.00
36"	CPU183684S5PKG	815.00
42"	CPU184284S5PKG	920.00
48"	CPU184884S5PKG	955.00
54"	CPU185484S5PKG	1,060.00
60"	CPU186084S5PKG	1,135.00
72"	CPU187284S5PKG	1,270.00

LENGTH	CODE	LIST PRICE EA.
22¼"	CPA182484S5PKG	\$ 530.00
28¾"	CPA183084S5PKG	620.00
34¼"	CPA183684S5PKG	675.00
40¼"	CPA184284S5PKG	780.00
46¼"	CPA184884S5PKG	815.00
52¼"	CPA185484S5PKG	920.00
58¼"	CPA186084S5PKG	990.00
70¼"	CPA187284S5PKG	1,130.00

21"
DEPTH

24"	CPU212484S4PKG	\$ 635.00
30"	CPU213084S4PKG	725.00
36"	CPU213684S4PKG	775.00
42"	CPU214284S4PKG	865.00
48"	CPU214884S4PKG	910.00
54"	CPU215484S4PKG	1,000.00
60"	CPU216084S4PKG	1,065.00
72"	CPU217284S4PKG	1,195.00

22¼"	CPA212484S4PKG	\$ 490.00
28¾"	CPA213084S4PKG	580.00
34¼"	CPA213684S4PKG	630.00
40¼"	CPA214284S4PKG	720.00
46¼"	CPA214884S4PKG	765.00
52¼"	CPA215484S4PKG	855.00
58¼"	CPA216084S4PKG	920.00
70¼"	CPA217284S4PKG	1,050.00

24"	CPU212484S5PKG	\$ 725.00
30"	CPU213084S5PKG	830.00
36"	CPU213684S5PKG	895.00
42"	CPU214284S5PKG	1,010.00
48"	CPU214884S5PKG	1,065.00
54"	CPU215484S5PKG	1,180.00
60"	CPU216084S5PKG	1,255.00
72"	CPU217284S5PKG	1,420.00

22¼"	CPA212484S5PKG	\$ 580.00
28¾"	CPA213084S5PKG	685.00
34¼"	CPA213684S5PKG	750.00
40¼"	CPA214284S5PKG	865.00
46¼"	CPA214884S5PKG	920.00
52¼"	CPA215484S5PKG	1,030.00
58¼"	CPA216084S5PKG	1,110.00
70¼"	CPA217284S5PKG	1,275.00

24"
DEPTH

24"	CPU242484S4PKG	\$ 660.00
30"	CPU243084S4PKG	750.00
36"	CPU243684S4PKG	805.00
42"	CPU244284S4PKG	885.00
48"	CPU244884S4PKG	940.00
54"	CPU245484S4PKG	1,025.00
60"	CPU246084S4PKG	1,085.00
72"	CPU247284S4PKG	1,220.00

22¼"	CPA242484S4PKG	\$ 515.00
28¾"	CPA243084S4PKG	600.00
34¼"	CPA243684S4PKG	655.00
40¼"	CPA244284S4PKG	740.00
46¼"	CPA244884S4PKG	795.00
52¼"	CPA245484S4PKG	875.00
58¼"	CPA246084S4PKG	935.00
70¼"	CPA247284S4PKG	1,075.00

24"	CPU242484S5PKG	\$ 755.00
30"	CPU243084S5PKG	860.00
36"	CPU243684S5PKG	930.00
42"	CPU244284S5PKG	1,030.00
48"	CPU244884S5PKG	1,105.00
54"	CPU245484S5PKG	1,205.00
60"	CPU246084S5PKG	1,280.00
72"	CPU247284S5PKG	1,450.00

22¼"	CPA242484S5PKG	\$ 605.00
28¾"	CPA243084S5PKG	715.00
34¼"	CPA243684S5PKG	785.00
40¼"	CPA244284S5PKG	885.00
46¼"	CPA244884S5PKG	955.00
52¼"	CPA245484S5PKG	1,060.00
58¼"	CPA246084S5PKG	1,135.00
70¼"	CPA247284S5PKG	1,305.00

Color: Speckled Gray (480).

VS4PKG

4-Shelf Vented and Solid Stationary Starter and Add-On Units

(3 vented + 1 solid)

VS5PKG

5-Shelf Vented and Solid Stationary Starter and Add-On Units

(4 vented + 1 solid)

Units ship in 2 or 3 separate boxes with 1 or 2 unassembled post kits and 1 box of 4 or 5 shelves.

84"
HEIGHT

18"
DEPTH

Starter

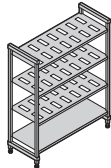

Add-On

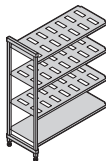

LENGTH	CODE	LIST PRICE EA.
24"	CPU182484VS4PKG	\$ 585.00
30"	CPU183084VS4PKG	655.00
36"	CPU183684VS4PKG	695.00
42"	CPU184284VS4PKG	775.00
48"	CPU184884VS4PKG	805.00
54"	CPU185484VS4PKG	885.00
60"	CPU186084VS4PKG	940.00
72"	CPU187284VS4PKG	1,045.00

LENGTH	CODE	LIST PRICE EA.
22¼"	CPA182484VS4PKG	\$ 445.00
28¾"	CPA183084VS4PKG	515.00
34¼"	CPA183684VS4PKG	555.00
40¼"	CPA184284VS4PKG	635.00
46¼"	CPA184884VS4PKG	660.00
52¼"	CPA185484VS4PKG	740.00
58¼"	CPA186084VS4PKG	795.00
70¼"	CPA187284VS4PKG	900.00

Starter

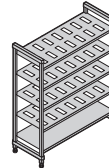

Add-On

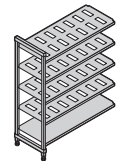

LENGTH	CODE	LIST PRICE EA.
24"	CPU182484VS5PKG	\$ 660.00
30"	CPU183084VS5PKG	750.00
36"	CPU183684VS5PKG	800.00
42"	CPU184284VS5PKG	900.00
48"	CPU184884VS5PKG	935.00
54"	CPU185484VS5PKG	1,030.00
60"	CPU186084VS5PKG	1,100.00
72"	CPU187284VS5PKG	1,230.00

LENGTH	CODE	LIST PRICE EA.
22¼"	CPA182484VS5PKG	\$ 515.00
28¾"	CPA183084VS5PKG	605.00
34¼"	CPA183684VS5PKG	655.00
40¼"	CPA184284VS5PKG	755.00
46¼"	CPA184884VS5PKG	790.00
52¼"	CPA185484VS5PKG	890.00
58¼"	CPA186084VS5PKG	955.00
70¼"	CPA187284VS5PKG	1,090.00

21"
DEPTH

24"	CPU212484VS4PKG	\$ 625.00
30"	CPU213084VS4PKG	710.00
36"	CPU213684VS4PKG	755.00
42"	CPU214284VS4PKG	845.00
48"	CPU214884VS4PKG	885.00
54"	CPU215484VS4PKG	970.00
60"	CPU216084VS4PKG	1,035.00
72"	CPU217284VS4PKG	1,160.00

22¼"	CPA212484VS4PKG	\$ 480.00
28¾"	CPA213084VS4PKG	565.00
34¼"	CPA213684VS4PKG	610.00
40¼"	CPA214284VS4PKG	700.00
46¼"	CPA214884VS4PKG	735.00
52¼"	CPA215484VS4PKG	825.00
58¼"	CPA216084VS4PKG	890.00
70¼"	CPA217284VS4PKG	1,010.00

24"	CPU212484VS5PKG	\$ 710.00
30"	CPU213084VS5PKG	810.00
36"	CPU213684VS5PKG	870.00
42"	CPU214284VS5PKG	985.00
48"	CPU214884VS5PKG	1,030.00
54"	CPU215484VS5PKG	1,140.00
60"	CPU216084VS5PKG	1,215.00
72"	CPU217284VS5PKG	1,370.00

22¼"	CPA212484VS5PKG	\$ 565.00
28¾"	CPA213084VS5PKG	665.00
34¼"	CPA213684VS5PKG	725.00
40¼"	CPA214284VS5PKG	840.00
46¼"	CPA214884VS5PKG	880.00
52¼"	CPA215484VS5PKG	995.00
58¼"	CPA216084VS5PKG	1,070.00
70¼"	CPA217284VS5PKG	1,225.00

24"
DEPTH

24"	CPU242484VS4PKG	\$ 640.00
30"	CPU243084VS4PKG	725.00
36"	CPU243684VS4PKG	780.00
42"	CPU244284VS4PKG	860.00
48"	CPU244884VS4PKG	910.00
54"	CPU245484VS4PKG	990.00
60"	CPU246084VS4PKG	1,045.00
72"	CPU247284VS4PKG	1,175.00

22¼"	CPA242484VS4PKG	\$ 495.00
28¾"	CPA243084VS4PKG	580.00
34¼"	CPA243684VS4PKG	630.00
40¼"	CPA244284VS4PKG	710.00
46¼"	CPA244884VS4PKG	765.00
52¼"	CPA245484VS4PKG	840.00
58¼"	CPA246084VS4PKG	895.00
70¼"	CPA247284VS4PKG	1,030.00

24"	CPU242484VS5PKG	\$ 725.00
30"	CPU243084VS5PKG	830.00
36"	CPU243684VS5PKG	895.00
42"	CPU244284VS5PKG	995.00
48"	CPU244884VS5PKG	1,065.00
54"	CPU245484VS5PKG	1,160.00
60"	CPU246084VS5PKG	1,230.00
72"	CPU247284VS5PKG	1,395.00

22¼"	CPA242484VS5PKG	\$ 580.00
28¾"	CPA243084VS5PKG	685.00
34¼"	CPA243684VS5PKG	750.00
40¼"	CPA244284VS5PKG	850.00
46¼"	CPA244884VS5PKG	915.00
52¼"	CPA245484VS5PKG	1,010.00
58¼"	CPA246084VS5PKG	1,080.00
70¼"	CPA247284VS5PKG	1,245.00

Color: Speckled Gray (480).

V4

4-Shelf Vented Mobile Starter Units

V5

5-Shelf Vented Mobile Starter Units

Units ship complete in 1 box and include 1 or 2 factory assembled post kits, traverses, shelf plates and 4 swivel, total locking casters.

67"

HEIGHT includes 5" casters.

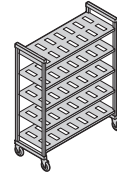
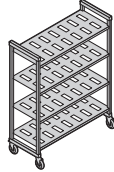

18"

DEPTH

CODE	DIMENSIONS D x L x H	LIST PRICE EA.
CPMU183667V4	18" x 36" x 67"	\$ 960.00
CPMU184267V4	18" x 42" x 67"	1,040.00
CPMU184867V4	18" x 48" x 67"	1,070.00

21"

DEPTH

CPMU213667V4	21" x 36" x 67"	\$ 1,020.00
CPMU214267V4	21" x 42" x 67"	1,110.00
CPMU214867V4	21" x 48" x 67"	1,145.00

24"

DEPTH

CPMU243667V4	24" x 36" x 67"	\$ 1,040.00
CPMU244267V4	24" x 42" x 67"	1,120.00
CPMU244867V4	24" x 48" x 67"	1,170.00

75"

HEIGHT includes 5" casters.

18"

DEPTH

CODE	DIMENSIONS D x L x H	LIST PRICE EA.
CPMU183675V4	18" x 36" x 75"	\$ 965.00
CPMU184275V4	18" x 42" x 75"	1,045.00
CPMU184875V4	18" x 48" x 75"	1,075.00

21"

DEPTH

CPMU213675V4	21" x 36" x 75"	\$ 1,025.00
CPMU214275V4	21" x 42" x 75"	1,115.00
CPMU214875V4	21" x 48" x 75"	1,150.00

24"

DEPTH

CPMU243675V4	24" x 36" x 75"	\$ 1,045.00
CPMU244275V4	24" x 42" x 75"	1,125.00
CPMU244875V4	24" x 48" x 75"	1,175.00

18"

DEPTH

CODE	DIMENSIONS D x L x H	LIST PRICE EA.
CPMU183667V5	18" x 36" x 67"	\$ 1,060.00
CPMU184267V5	18" x 42" x 67"	1,160.00
CPMU184867V5	18" x 48" x 67"	1,195.00

21"

DEPTH

CPMU213667V5	21" x 36" x 67"	\$ 1,135.00
CPMU214267V5	21" x 42" x 67"	1,245.00
CPMU214867V5	21" x 48" x 67"	1,290.00

24"

DEPTH

CPMU243667V5	24" x 36" x 67"	\$ 1,155.00
CPMU244267V5	24" x 42" x 67"	1,255.00
CPMU244867V5	24" x 48" x 67"	1,320.00

18"

DEPTH

CODE	DIMENSIONS D x L x H	LIST PRICE EA.
CPMU183675V5	18" x 36" x 75"	\$ 1,065.00
CPMU184275V5	18" x 42" x 75"	1,165.00
CPMU184875V5	18" x 48" x 75"	1,200.00

21"

DEPTH

CPMU213675V5	21" x 36" x 75"	\$ 1,140.00
CPMU214275V5	21" x 42" x 75"	1,250.00
CPMU214875V5	21" x 48" x 75"	1,295.00

24"

DEPTH

CPMU243675V5	24" x 36" x 75"	\$ 1,165.00
CPMU244275V5	24" x 42" x 75"	1,260.00
CPMU244875V5	24" x 48" x 75"	1,330.00

HIGH DENSITY STORAGE FLOOR TRACK SYSTEM

Maximize storage capacity by creating storage aisles in all available space. This simple system is composed of stationary starter units anchored to a raised floor track system at both ends with high density mobile units installed in between. Easy to install track requires no drilling or gluing.



Increases Storage Capacity Up To

50%

High Density Mobile Units ship complete in 1 box and include factory assembled post kits, vented or solid shelves and high density casters and donut bumpers. Full track and extension kits ship complete with required hardware.

Stationary Starter Units are required to anchor the system at both ends (see Premium Series Stationary Starter Unit spec pages). The Ultimate #10 Can Rack Unit may also be installed on either end, offering high capacity can storage in a compact space.

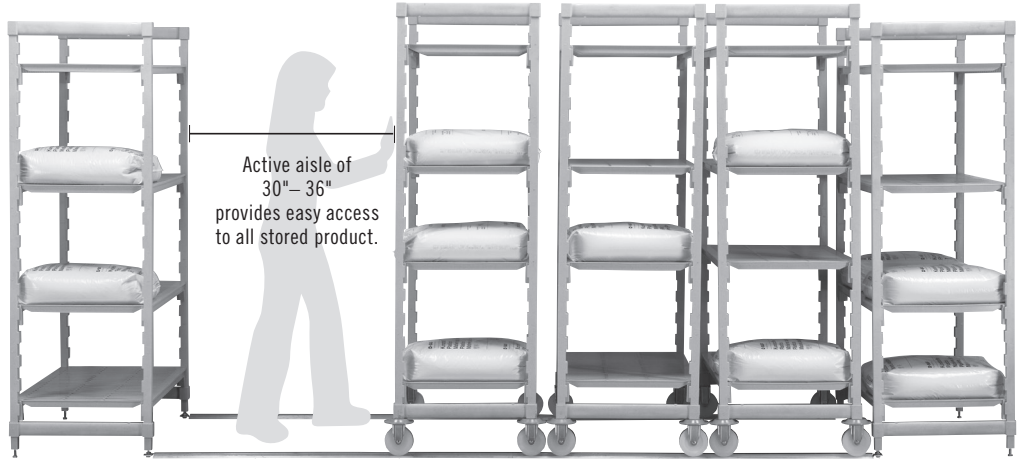

Stationary Unit*

High Density Mobile Units

Stationary Unit

Raised Floor Track provides a smooth and level surface to easily roll mobile units. Raised track ensures dirt will not get trapped and is easy to clean. Aluminum track and stainless steel hardware are rust resistant.

*It is recommended to use a stationary unit for every 15' of track to further stabilize the system.



Grooved casters roll easily and securely on raised track.



Raised track connects easily to the bottom of a stationary unit that works as a system anchor. No bolts, no glue or drilling into the floor are required. Easy and fast set up.

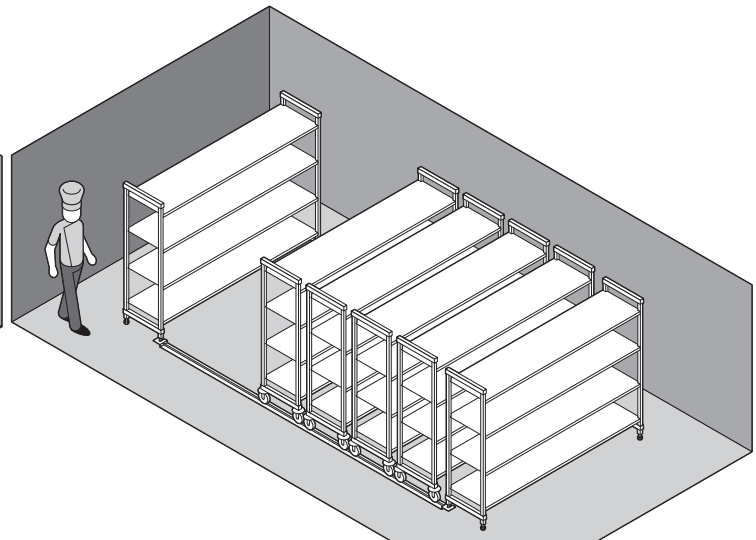
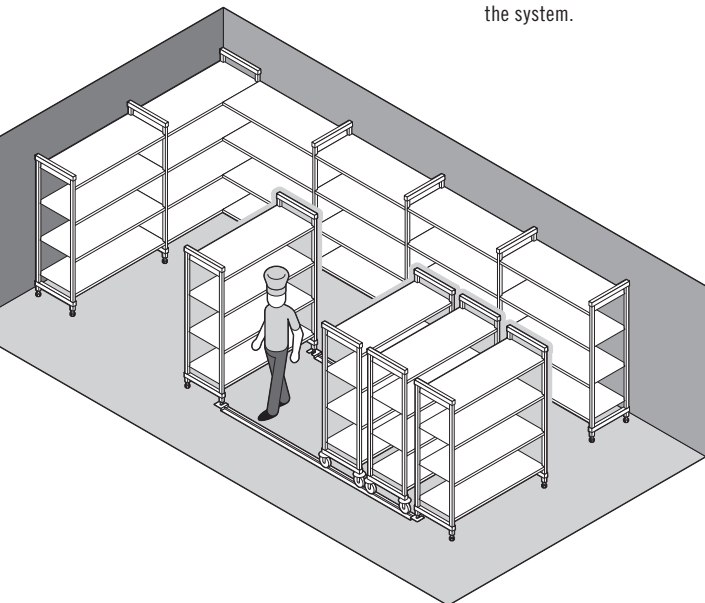

High Density Full Track and Track Extension Kits

Each kit ships complete in 1 box with aluminum raised track rails and stainless steel hardware required to complete installation.

CODE	DESCRIPTION	CASE PACK	LIST PRICE EA.
Full Track Kits			
CSMHDTK10	10' Track for 3 Mobile Units*	1	\$ 670.00
CSMHDTK12	12' Track for 4 Mobile Units*	1	775.00
CSMHDTK145	14.5' Track for 5 Mobile Units*	1	870.00

Color: Silver (000). *Based on 24" deep mobile units.

Full Track Kits include: Track rails, rail joiners, end plates, 8 stainless steel leveling feet (for stationary units) and required hardware.

CODE	DESCRIPTION	CASE PACK	LIST PRICE EA.
Track Extension Kits			
CSMHDTKE4	4.5' Track Extension	1	\$ 253.00
CSMHDTKE5	5' Track Extension	1	270.00
CSMHDTKE6	6' Track Extension	1	320.00

Color: Silver (000). **Extension Track Kits include:** Track rails (1 set), 2 rail joiners, and required hardware.

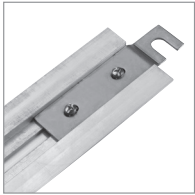

Track rail (underside) shown with end plate installed.



Track rail (underside) shown with track rail joiner partially installed.

It is highly recommended to install a stationary starter unit every 15' of track to further stabilize the system.

High Density Floor Fastener

Secure stationary unit front posts with rails directly to the floor for added safety and stability where required. Made of stainless steel. Bolts not included.



Hole diameter 9/16".

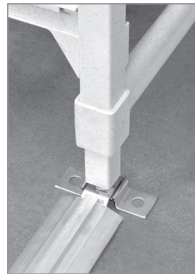

CODE	DIMENSION D x L x H	LIST PRICE EA.
------	------------------------	-------------------

Premium Series High Density

CSHDF 1 3/8" x 4 1/4" x 1/2" \$ 43.40

Case Pack: 4 Color: Silver (000).

High Density Caster With Donut Bumper



CODE	SIZE	LIST PRICE EA.
CPMCHD	5"	\$ 58.35

Case Pack: 2 Color: Gray (000).



V4

4-Shelf Vented High Density Mobile Units

S4

4-Shelf Solid High Density Mobile Units

Units ship complete in 1 box and include 1 or 2 factory assembled post kits, traverses, shelf plates, 4 high density casters and 4 donut bumpers.

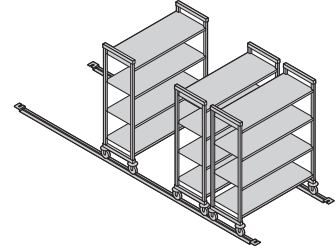
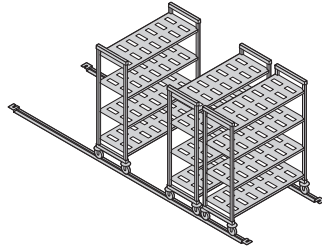

67"

HEIGHT includes 5" casters.

21"

DEPTH

CODE	DIMENSIONS D x L x H	LIST PRICE EA.
CPHU213667V4	21" x 36" x 67"	\$ 1,040.00
CPHU214267V4	21" x 42" x 67"	1,130.00
CPHU214867V4	21" x 48" x 67"	1,165.00
CPHU215467V4	21" x 54" x 67"	1,255.00
CPHU216067V4	21" x 60" x 67"	1,315.00

24"

DEPTH

CPHU243667V4	24" x 36" x 67"	\$ 1,060.00
CPHU244267V4	24" x 42" x 67"	1,140.00
CPHU244867V4	24" x 48" x 67"	1,195.00
CPHU245467V4	24" x 54" x 67"	1,270.00
CPHU246067V4	24" x 60" x 67"	1,320.00

75"

HEIGHT includes 5" casters.

21"

DEPTH

CODE	DIMENSIONS D x L x H	LIST PRICE EA.
CPHU213675V4	21" x 36" x 75"	\$ 1,050.00
CPHU214275V4	21" x 42" x 75"	1,135.00
CPHU214875V4	21" x 48" x 75"	1,170.00
CPHU215475V4	21" x 54" x 75"	1,260.00
CPHU216075V4	21" x 60" x 75"	1,320.00

24"

DEPTH

CPHU243675V4	24" x 36" x 75"	\$ 1,065.00
CPHU244275V4	24" x 42" x 75"	1,145.00
CPHU244875V4	24" x 48" x 75"	1,200.00
CPHU245475V4	24" x 54" x 75"	1,275.00
CPHU246075V4	24" x 60" x 75"	1,330.00

21"

DEPTH

CODE	DIMENSIONS D x L x H	LIST PRICE EA.
CPHU213667S4	21" x 36" x 67"	\$ 1,065.00
CPHU214267S4	21" x 42" x 67"	1,160.00
CPHU214867S4	21" x 48" x 67"	1,200.00
CPHU215467S4	21" x 54" x 67"	1,290.00
CPHU216067S4	21" x 60" x 67"	1,355.00

24"

DEPTH

CPHU243667S4	24" x 36" x 67"	\$ 1,095.00
CPHU244267S4	24" x 42" x 67"	1,175.00
CPHU244867S4	24" x 48" x 67"	1,235.00
CPHU245467S4	24" x 54" x 67"	1,315.00
CPHU246067S4	24" x 60" x 67"	1,375.00

21"

DEPTH

CODE	DIMENSIONS D x L x H	LIST PRICE EA.
CPHU213675S4	21" x 36" x 75"	\$ 1,070.00
CPHU214275S4	21" x 42" x 75"	1,165.00
CPHU214875S4	21" x 48" x 75"	1,205.00
CPHU215475S4	21" x 54" x 75"	1,300.00
CPHU216075S4	21" x 60" x 75"	1,360.00

24"

DEPTH

CPHU243675S4	24" x 36" x 75"	\$ 1,100.00
CPHU244275S4	24" x 42" x 75"	1,180.00
CPHU244875S4	24" x 48" x 75"	1,240.00
CPHU245475S4	24" x 54" x 75"	1,320.00
CPHU246075S4	24" x 60" x 75"	1,380.00



High Density Mobile Post Kits

Ships **unassembled** in 1 box. Includes 2 mobile posts, post connectors, 2 high density casters and donut bumpers. Mobile and stationary posts are not interchangeable.

67"

HEIGHT includes 5" casters.

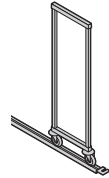

18"
DEPTH

CODE	DIMENSIONS D x H	LIST PRICE EA.
CPMPKHD1867	18" x 67"	\$ 266.00

21"
DEPTH

CPMPKHD2167	21" x 67"	\$ 269.00
-------------	-----------	-----------

24"
DEPTH

CPMPKHD2467	24" x 67"	\$ 270.00
-------------	-----------	-----------



75"

HEIGHT includes 5" casters.

18"
DEPTH

CODE	DIMENSIONS D x H	LIST PRICE EA.
CPMPKHD1875	18" x 75"	\$ 268.00

21"
DEPTH

CPMPKHD2175	21" x 75"	\$ 271.00
-------------	-----------	-----------

24"
DEPTH

CPMPKHD2475	24" x 75"	\$ 272.00
-------------	-----------	-----------

Color: Speckled Gray (480).

Stationary Post Kits

Ships **unassembled** in 1 box.
Includes 2 stationary posts and post connectors.
Mobile and stationary posts are not interchangeable.

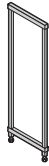

32"
HEIGHT

CODE	DIMENSIONS D x H	LIST PRICE EA.
CPPK1432	14" x 32"	\$ 77.50
CPPK1832	18" x 32"	82.95
CPPK2132	21" x 32"	86.10
CPPK2432	24" x 32"	87.00

56"
HEIGHT

CPPK1456	14" x 56"	\$ 106.00
CPPK1856	18" x 56"	111.00
CPPK2156	21" x 56"	115.00
CPPK2456	24" x 56"	115.00

64"
HEIGHT

CPPK1464	14" x 64"	\$ 116.00
CPPK1864	18" x 64"	121.00
CPPK2164	21" x 64"	124.00
CPPK2464	24" x 64"	125.00

72"
HEIGHT

CPPK1472	14" x 72"	\$ 118.00
CPPK1872	18" x 72"	124.00
CPPK2172	21" x 72"	127.00
CPPK2472	24" x 72"	128.00

84"
HEIGHT

CPPK1484	14" x 84"	\$ 137.00
CPPK1884	18" x 84"	143.00
CPPK2184	21" x 84"	146.00
CPPK2484	24" x 84"	147.00

Color: Speckled Gray (480).

Standard Mobile Post Kits

Ships **unassembled** in 1 box. Includes 2 mobile posts,
post connectors and 2 swivel, total locking casters.
Mobile and stationary posts are not interchangeable.



35"
HEIGHT
includes
5" casters.

CODE	DIMENSIONS D x H	LIST PRICE EA.
CPMPK1835	18" x 35"	\$ 237.00
CPMPK2135	21" x 35"	240.00
CPMPK2435	24" x 35"	241.00

59"
HEIGHT
includes
5" casters.

CPMPK1859	18" x 59"	\$ 267.00
CPMPK2159	21" x 59"	270.00
CPMPK2459	24" x 59"	271.00

67"
HEIGHT
includes
5" casters.

CPMPK1867	18" x 67"	\$ 277.00
CPMPK2167	21" x 67"	280.00
CPMPK2467	24" x 67"	281.00

75"
HEIGHT
includes
5" casters.

CPMPK1875	18" x 75"	\$ 280.00
CPMPK2175	21" x 75"	283.00
CPMPK2475	24" x 75"	284.00

Color: Speckled Gray (480).

Standard Mobile Donut Bumper

Offers added protection during transport and when maneuvering mobile units into place against walls or alongside other units for storage. Cannot be used on High Density Mobile Units.



CODE	DIAMETER	LIST PRICE EA.
CPMDB	3½"	\$ 10.10

Case Pack: 4 Color: Gray (000).

V1

Single Vented Shelf Kits

S1

Single Solid Shelf Kits

Includes 2 shelf traverses and vented or solid shelf plates.
Fits mobile or stationary units. Ships in 1 box.

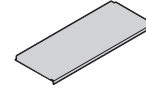
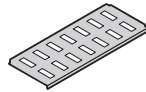

14"
DEPTH

CODE	DIMENSIONS D x L	LIST PRICE EA.
CPSK1424V1	14" x 24"	\$ 72.25
CPSK1430V1	14" x 30"	89.80
CPSK1436V1	14" x 36"	99.50
CPSK1442V1	14" x 42"	114.00
CPSK1448V1	14" x 48"	126.00
CPSK1454V1	14" x 54"	140.00
CPSK1460V1	14" x 60"	151.00
CPSK1472V1	14" x 72"	177.00

14"
DEPTH

CODE	DIMENSIONS D x L	LIST PRICE EA.
CPSK1424S1	14" x 24"	\$ 74.05
CPSK1430S1	14" x 30"	91.95
CPSK1436S1	14" x 36"	102.00
CPSK1442S1	14" x 42"	118.00
CPSK1448S1	14" x 48"	130.00
CPSK1454S1	14" x 54"	145.00
CPSK1460S1	14" x 60"	157.00
CPSK1472S1	14" x 72"	184.00

18"
DEPTH

CPSK1824V1	18" x 24"	\$ 74.10
CPSK1830V1	18" x 30"	91.65
CPSK1836V1	18" x 36"	101.50
CPSK1842V1	18" x 42"	121.00
CPSK1848V1	18" x 48"	128.00
CPSK1854V1	18" x 54"	148.00
CPSK1860V1	18" x 60"	161.00
CPSK1872V1	18" x 72"	187.00

18"
DEPTH

CPSK1824S1	18" x 24"	\$ 77.70
CPSK1830S1	18" x 30"	95.60
CPSK1836S1	18" x 36"	106.00
CPSK1842S1	18" x 42"	127.00
CPSK1848S1	18" x 48"	134.00
CPSK1854S1	18" x 54"	155.00
CPSK1860S1	18" x 60"	170.00
CPSK1872S1	18" x 72"	197.00

21"
DEPTH

CPSK2124V1	21" x 24"	\$ 83.00
CPSK2130V1	21" x 30"	103.00
CPSK2136V1	21" x 36"	115.00
CPSK2142V1	21" x 42"	137.00
CPSK2148V1	21" x 48"	145.00
CPSK2154V1	21" x 54"	168.00
CPSK2160V1	21" x 60"	183.00
CPSK2172V1	21" x 72"	213.00

21"
DEPTH

CPSK2124S1	21" x 24"	\$ 86.40
CPSK2130S1	21" x 30"	108.00
CPSK2136S1	21" x 36"	121.00
CPSK2142S1	21" x 42"	144.00
CPSK2148S1	21" x 48"	155.00
CPSK2154S1	21" x 54"	177.00
CPSK2160S1	21" x 60"	193.00
CPSK2172S1	21" x 72"	226.00

24"
DEPTH

CPSK2424V1	24" x 24"	\$ 84.95
CPSK2430V1	24" x 30"	106.00
CPSK2436V1	24" x 36"	119.00
CPSK2442V1	24" x 42"	139.00
CPSK2448V1	24" x 48"	152.00
CPSK2454V1	24" x 54"	171.00
CPSK2460V1	24" x 60"	184.00
CPSK2472V1	24" x 72"	217.00

24"
DEPTH

CPSK2424S1	24" x 24"	\$ 92.00
CPSK2430S1	24" x 30"	114.00
CPSK2436S1	24" x 36"	128.00
CPSK2442S1	24" x 42"	148.00
CPSK2448S1	24" x 48"	162.00
CPSK2454S1	24" x 54"	182.00
CPSK2460S1	24" x 60"	198.00
CPSK2472S1	24" x 72"	232.00

V4 4-Shelf Vented Kits

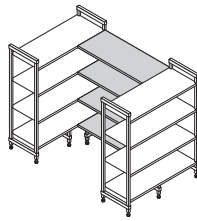

Includes 8 shelf traverses and vented or solid shelf plates. Fits mobile or stationary units.
Ships in 1 box. Install with 8 sets of corner connectors (CPC8) to create a U-shape unit.

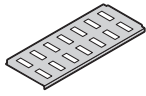

18"
DEPTH

CODE	DIMENSIONS D x L	LIST PRICE EA.
CPSK1836V4	18" x 36"	\$ 405.00
CPSK1842V4	18" x 42"	485.00
CPSK1848V4	18" x 48"	515.00

21"
DEPTH

CPSK2136V4	21" x 36"	\$ 460.00
CPSK2142V4	21" x 42"	550.00
CPSK2148V4	21" x 48"	580.00

24"
DEPTH

CPSK2436V4	24" x 36"	\$ 475.00
CPSK2442V4	24" x 42"	555.00
CPSK2448V4	24" x 48"	610.00

S4 4-Shelf Solid Kits

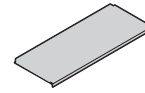

18"
DEPTH

CODE	DIMENSIONS D x L	LIST PRICE EA.
CPSK1836S4	18" x 36"	\$ 425.00
CPSK1842S4	18" x 42"	510.00
CPSK1848S4	18" x 48"	535.00

21"
DEPTH

CPSK2136S4	21" x 36"	\$ 485.00
CPSK2142S4	21" x 42"	575.00
CPSK2148S4	21" x 48"	620.00

24"
DEPTH

CPSK2436S4	24" x 36"	\$ 510.00
CPSK2442S4	24" x 42"	590.00
CPSK2448S4	24" x 48"	645.00

V5 5-Shelf Vented Kits

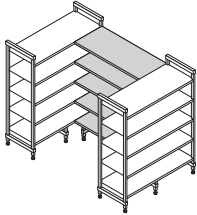

Includes 10 shelf traverses and vented or solid shelf plates. Fits mobile or stationary units.
Ships in 1 box. Install with 10 sets of corner connectors (CPC10) to create a U-shape unit.

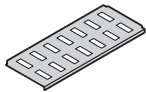

18"
DEPTH

CODE	DIMENSIONS D x L	LIST PRICE EA.
CPSK1836V5	18" x 36"	\$ 505.00
CPSK1842V5	18" x 42"	605.00
CPSK1848V5	18" x 48"	640.00

21"
DEPTH

CPSK2136V5	21" x 36"	\$ 575.00
CPSK2142V5	21" x 42"	685.00
CPSK2148V5	21" x 48"	725.00

24"
DEPTH

CPSK2436V5	24" x 36"	\$ 595.00
CPSK2442V5	24" x 42"	695.00
CPSK2448V5	24" x 48"	760.00

S5 5-Shelf Solid Kits

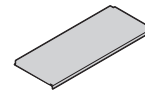

18"
DEPTH

CODE	DIMENSIONS D x L	LIST PRICE EA.
CPSK1836S5	18" x 36"	\$ 530.00
CPSK1842S5	18" x 42"	635.00
CPSK1848S5	18" x 48"	670.00

21"
DEPTH

CPSK2136S5	21" x 36"	\$ 605.00
CPSK2142S5	21" x 42"	720.00
CPSK2148S5	21" x 48"	775.00

24"
DEPTH

CPSK2436S5	24" x 36"	\$ 640.00
CPSK2442S5	24" x 42"	740.00
CPSK2448S5	24" x 48"	810.00



VS4 4-Shelf Kits

(3 Vented + 1 Solid)

Includes 8 shelf traverses and vented or solid shelf plates.
Fits mobile or stationary units. Ships in one carton. Install with
8 sets of corner connectors (CPCC8) to create a U-shape unit.

18"
DEPTH

CODE	DIMENSIONS D x L	LIST PRICE EA.
CPSK1836VS4	18" x 36"	\$ 410.00
CPSK1842VS4	18" x 42"	490.00
CPSK1848VS4	18" x 48"	520.00

21"
DEPTH

CPSK2136VS4	21" x 36"	\$ 465.00
CPSK2142VS4	21" x 42"	555.00
CPSK2148VS4	21" x 48"	590.00

24"
DEPTH

CPSK2436VS4	24" x 36"	\$ 485.00
CPSK2442VS4	24" x 42"	565.00
CPSK2448VS4	24" x 48"	620.00



VS5 5-Shelf Kits

(4 Vented + 1 Solid)

Includes 10 shelf traverses and vented or solid shelf plates.
Fits mobile or stationary units. Ships in one carton. Install with
10 sets of corner connectors (CPCC10) to create a U-shape unit.

18"
DEPTH

CODE	DIMENSIONS D x L	LIST PRICE EA.
CPSK1836VS5	18" x 36"	\$ 510.00
CPSK1842VS5	18" x 42"	610.00
CPSK1848VS5	18" x 48"	645.00

21"
DEPTH

CPSK2136VS5	21" x 36"	\$ 580.00
CPSK2142VS5	21" x 42"	690.00
CPSK2148VS5	21" x 48"	735.00

24"
DEPTH

CPSK2436VS5	24" x 36"	\$ 605.00
CPSK2442VS5	24" x 42"	705.00
CPSK2448VS5	24" x 48"	770.00

Color: Speckled Gray (480).

Corner Connectors

Unique patented design ensures maximum shelf space utilization. Use 1 set per shelf to connect starter and add-on units in corners. Connect 4 or 5 intermediate shelves between 2 starter units (2 sets required per shelf). Available as a single set or 8 or 10 set packs.

CODE	DESCRIPTION	LIST PRICE EA.
CPCC1	1 Set for 1 shelf	\$ 5.85
CPCC8	8 Sets for 4 shelves	46.60
CPCC10	10 Sets for 5 shelves	58.30

Color: Speckled Gray (480).

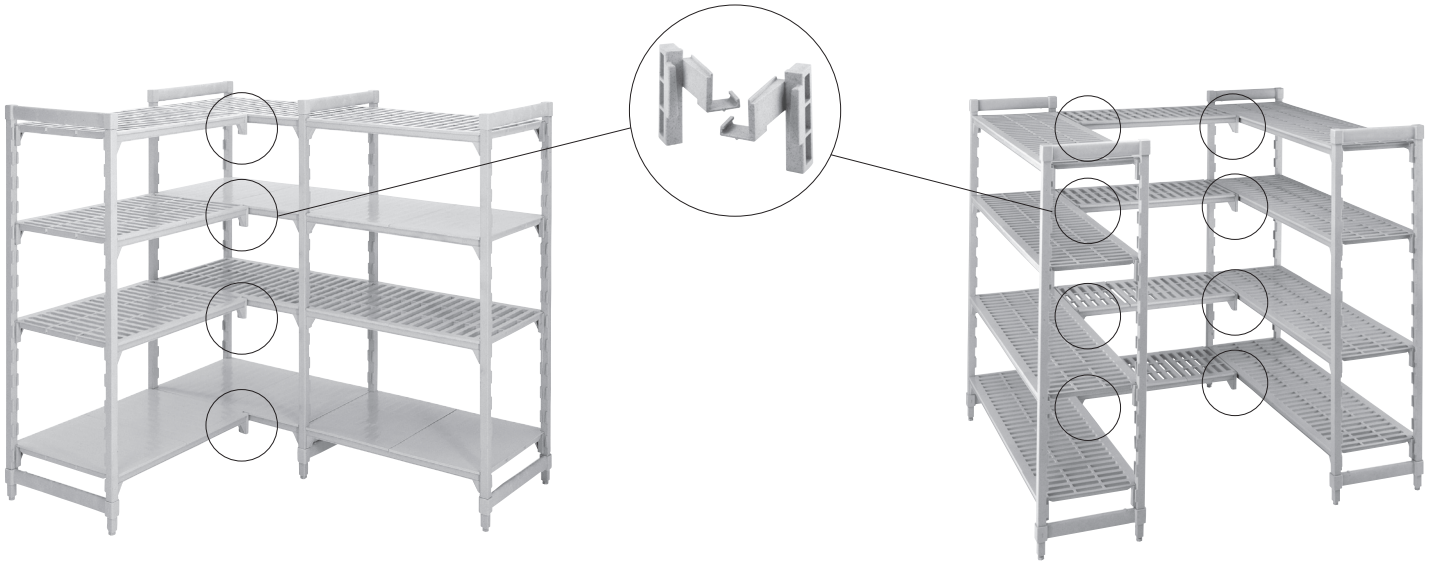

Bottom Shelf Dunnage Stands

Increase weight bearing capacity on bottom shelf only. Add to any shelf length. Highly recommended for starter units 54" and longer and all corner units, intermediate units and units specified for heavier load volume on and off bottom shelves.

CODE	DIMENSIONS D x H	LIST PRICE EA.
Dunnage Stand – Low (bottom shelf installed on lowest post dovetails)		
CPDS14H6	14" x 7½"	\$ 76.90
CPDS18H6	18" x 7½"	79.45
CPDS21H6	21" x 7½"	81.45
CPDS24H6	24" x 7½"	83.50

Dunnage Stand – Tall (bottom shelf installed on 2nd set up of post dovetails)		
CPDS14H11	14" x 11⅜"	83.25
CPDS18H11	18" x 11⅜"	85.85
CPDS21H11	21" x 11⅜"	87.85
CPDS24H11	24" x 11⅜"	89.90

Case Pack: 1 Color: Speckled Gray (480).

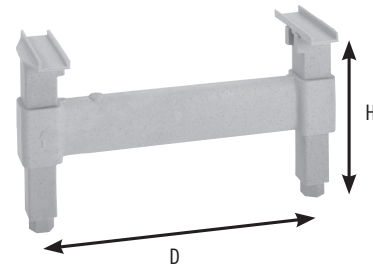

Bottom Shelf with Dunnage Stand

UNIT LENGTH	WEIGHT BEARING
Standard Unit	
24" - 48"	1,200 lbs.
54" - 72"	900
Corner Unit with 2 Dunnage Stands	
24" - 48"	600

Shelf Traverses

Available in single or double packs. Use a single set to add an open shelf for divider bars or drying racks. Add single traverse on the back of the unit for extra support when significant space is required between the bottom and second shelf or when placing rolling equipment under the first shelf.



LENGTH	SINGLE PACK CODE*	LIST PRICE EA.	DOUBLE PACK CODE**	LIST PRICE EA.
24"	CPTR24	\$ 33.90	CPTR242PK	\$ 59.35
30"	CPTR30	36.65	CPTR302PK	64.25
36"	CPTR36	39.90	CPTR362PK	69.85
42"	CPTR42	42.65	CPTR422PK	76.15
48"	CPTR48	46.50	CPTR482PK	83.05
54"	CPTR54	50.50	CPTR542PK	90.10
60"	CPTR60	54.40	CPTR602PK	97.15
72"	CPTR72	59.35	—	—

*Case Pack: 1 **Case Pack: 2 Color: Speckled Gray (480).



CAMSHELVING ELEMENTS® series

STATIONARY | MOBILE | UNDERCOUNTER

WHY CHOOSE ELEMENTS?

Made from a revolutionary, extremely strong composite material with a smooth, easy to clean surface. Elements Series is stronger than common wire shelving. It's lighter in weight than Camshelving Premium Series and totally impervious to moisture, chemicals and liquids that can destroy shelving over time. Elements Series is designed for medium to heavy storage use in freezers, coolers, dry storage or warewashing areas. It easily supports the performance demands of a busy foodservice operation.

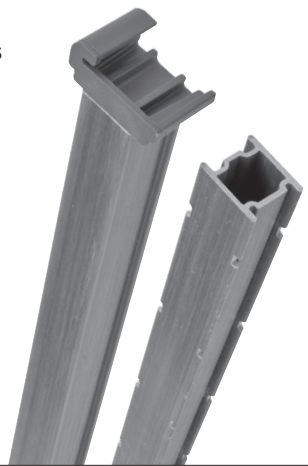

camguard.
ANTIMICROBIAL SHELF PLATES



**StoreSafe
StaySafe**

Post Connectors, Corner Connectors, Floor Fastener, Wall Fastener, Identification Tags, Single Shelf Security Cage, Ultimate #10 Can Rack, and Shelf Divider Bars are not NSF Listed.

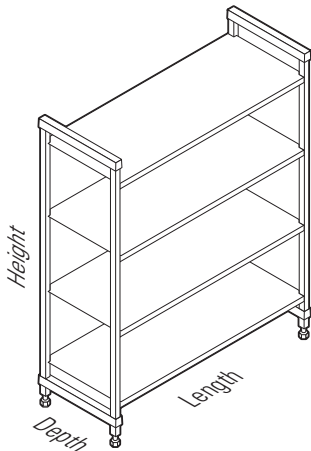

Stationary Unit Sizes

4 Depths	
14" 18"	21" 24"
8 Lengths	
24" 30" 36"	42" 48" 54"
60" 72"	
3 Heights	
64" 72" 84"	

Mobile Unit Sizes

3 Depths	
18" 21" 24"	
5 Lengths	
36" 42" 48"	54" 60"
2 Heights	
70¼" 78¼"	

Undercounter Unit Sizes

2 Depths	
14" 18"	
3 Lengths	
24" 36" 48"	
2 Heights	
27¼" mobile	30" stationary

Weight Bearing Capacity

Weight must be evenly distributed across the entire shelf.

		UNIT LENGTH 24" – 48"	UNIT LENGTH 54" – 72"
SINGLE UNIT	Unit only	2,000 lbs.	2,000 lbs.
	Shelf only	800	600
	Unit with dunnage stand*	2,400	2,300
	Bottom shelf with dunnage stand*	1,200	900
CORNER UNIT*** With 2 Dunnage Stands required	Unit only	1,800	—
	Shelf only	400	—
	Bottom shelf with dunnage stands*	600	—
MOBILE UNIT	Unit only**	750	750

*Dunnage Stands add stability and increase weight bearing capacity on bottom shelf only. Add to any shelf length. Highly recommended for Starter Units 54" and longer, all Corner Units, U-Shape Units and units specified for heavier loads (See page 04).

**Due to the weight bearing capacity of casters, maximum weight load on an entire Mobile Unit (Standard Mobile or High Density) is 750 lbs.

***Corner connectors are for use only with shelves 24" - 48" long.



CAMSHELVING ELEMENTS® SERIES – STARTER, ADD-ON AND MOBILE UNITS

V4 4-Shelf or 5-Shelf Vented
V5 Stationary Starter
 and Add-On Units

HEIGHTS	DEPTHS	LENGTHS	
3	3	8	
64"	18"	24"	48"
72"	21"	30"	54"
84"	24"	36"	60"
		42"	72"

V2 2-Shelf Undercounter Vented
 Stationary Starter Units

HEIGHT	DEPTH	LENGTHS
1	1	2
30"	18"	36"
		48"

S4 4-Shelf Solid Stationary
 Starter and Add-On Units

HEIGHTS	DEPTHS	LENGTHS	
3	3	8	
64"	18"	24"	48"
72"	21"	30"	54"
84"	24"	36"	60"
		42"	72"

S5 5-Shelf Solid Stationary
 Starter and Add-On Units

HEIGHT	DEPTHS	LENGTHS	
1	3	8	
84"	18"	24"	48"
	21"	30"	54"
	24"	36"	60"
		42"	72"

VS4 4-Shelf Vented and Solid
 Stationary Starter and
 Add-On Units (3 vented + 1 solid)

HEIGHTS	DEPTHS	LENGTHS	
3	3	8	
64"	18"	24"	48"
72"	21"	30"	54"
84"	24"	36"	60"
		42"	72"

VS5 5-Shelf Vented and Solid
 Stationary Starter and
 Add-On Units (4 vented + 1 solid)

HEIGHT	DEPTHS	LENGTHS	
1	3	8	
84"	18"	24"	48"
	21"	30"	54"
	24"	36"	60"
		42"	72"

V4 4-Shelf or 5-Shelf Vented
V5 Mobile Starter Units

HEIGHTS*	DEPTHS	LENGTHS	
2	3	5	
70¼"	18"	36"	54"
78¼"	21"	42"	60"
	24"	48"	

*Includes 5" casters.

V2 2-Shelf Undercounter Vented
 Mobile Starter Units

HEIGHT*	DEPTH	LENGTHS
1	1	3
27¼"	14"	24"
		36"
		48"

*Includes 5" casters.

V4

4-Shelf Vented Stationary Starter and Add-On Units

V5

5-Shelf Vented Stationary Starter and Add-On Units

Units ship complete in 1 box and include 1 or 2 factory assembled post kits, traverses, dovetails and shelf plates.

64"
HEIGHT

18"
DEPTH

Starter

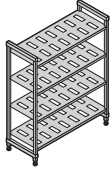

Add-On

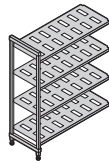

LENGTH	CODE	LIST PRICE EA.
24"	ESU182464V4	\$ 440.00
30"	ESU183064V4	450.00
36"	ESU183664V4	495.00
42"	ESU184264V4	555.00
48"	ESU184864V4	580.00
54"	ESU185464V4	640.00
60"	ESU186064V4	680.00
72"	ESU187264V4	760.00

LENGTH	CODE	LIST PRICE EA.
22"	EA182464V4	\$ 345.00
28"	EA183064V4	360.00
34"	EA183664V4	405.00
40"	EA184264V4	465.00
46"	EA184864V4	490.00
52"	EA185464V4	550.00
58"	EA186064V4	590.00
70"	EA187264V4	670.00

Starter

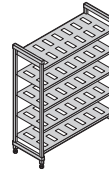

Add-On

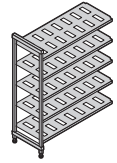

LENGTH	CODE	LIST PRICE EA.
24"	ESU182464V5	\$ 500.00
30"	ESU183064V5	520.00
36"	ESU183664V5	575.00
42"	ESU184264V5	650.00
48"	ESU184864V5	680.00
54"	ESU185464V5	755.00
60"	ESU186064V5	805.00
72"	ESU187264V5	905.00

LENGTH	CODE	LIST PRICE EA.
22"	EA182464V5	\$ 410.00
28"	EA183064V5	430.00
34"	EA183664V5	485.00
40"	EA184264V5	560.00
46"	EA184864V5	585.00
52"	EA185464V5	665.00
58"	EA186064V5	715.00
70"	EA187264V5	815.00

21"
DEPTH

24"	ESU212464V4	\$ 475.00
30"	ESU213064V4	490.00
36"	ESU213664V4	540.00
42"	ESU214264V4	610.00
48"	ESU214864V4	635.00
54"	ESU215464V4	705.00
60"	ESU216064V4	755.00
72"	ESU217264V4	850.00

22"	EA212464V4	\$ 380.00
28"	EA213064V4	395.00
34"	EA213664V4	450.00
40"	EA214264V4	515.00
46"	EA214864V4	545.00
52"	EA215464V4	615.00
58"	EA216064V4	660.00
70"	EA217264V4	755.00

24"	ESU212464V5	\$ 545.00
30"	ESU213064V5	565.00
36"	ESU213664V5	630.00
42"	ESU214264V5	715.00
48"	ESU214864V5	750.00
54"	ESU215464V5	835.00
60"	ESU216064V5	895.00
72"	ESU217264V5	1,015.00

22"	EA212464V5	\$ 450.00
28"	EA213064V5	470.00
34"	EA213664V5	535.00
40"	EA214264V5	625.00
46"	EA214864V5	655.00
52"	EA215464V5	745.00
58"	EA216064V5	800.00
70"	EA217264V5	920.00

24"
DEPTH

24"	ESU242464V4	\$ 485.00
30"	ESU243064V4	510.00
36"	ESU243664V4	555.00
42"	ESU244264V4	620.00
48"	ESU244864V4	660.00
54"	ESU245464V4	715.00
60"	ESU246064V4	760.00
72"	ESU247264V4	860.00

22"	EA242464V4	\$ 390.00
28"	EA243064V4	415.00
34"	EA243664V4	460.00
40"	EA244264V4	525.00
46"	EA244864V4	565.00
52"	EA245464V4	620.00
58"	EA246064V4	665.00
70"	EA247264V4	765.00

24"	ESU242464V5	\$ 560.00
30"	ESU243064V5	590.00
36"	ESU243664V5	650.00
42"	ESU244264V5	725.00
48"	ESU244864V5	775.00
54"	ESU245464V5	850.00
60"	ESU246064V5	900.00
72"	ESU247264V5	1,030.00

22"	EA242464V5	\$ 465.00
28"	EA243064V5	500.00
34"	EA243664V5	555.00
40"	EA244264V5	630.00
46"	EA244864V5	680.00
52"	EA245464V5	755.00
58"	EA246064V5	810.00
70"	EA247264V5	935.00

Color: Brushed Graphite (580).

S4

4-Shelf Solid Stationary Starter and Add-On Units

VS4

4-Shelf Vented and Solid Stationary Starter and Add-On Units

(3 Vented + 1 Solid)

Units ship complete in 1 box and include 1 or 2 factory assembled post kits, traverses, dovetails and shelf plates.

64"

HEIGHT

Starter

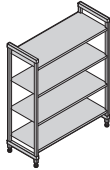

Add-On

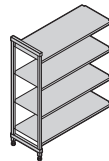

18"

DEPTH

LENGTH	CODE	LIST PRICE EA.
24"	ESU182464S4	\$ 460.00
30"	ESU183064S4	465.00
36"	ESU183664S4	510.00
42"	ESU184264S4	575.00
48"	ESU184864S4	595.00
54"	ESU185464S4	660.00
60"	ESU186064S4	710.00
72"	ESU187264S4	790.00

LENGTH	CODE	LIST PRICE EA.
22"	EA182464S4	\$ 370.00
28"	EA183064S4	370.00
34"	EA183664S4	420.00
40"	EA184264S4	485.00
46"	EA184864S4	505.00
52"	EA185464S4	570.00
58"	EA186064S4	615.00
70"	EA187264S4	700.00

Starter

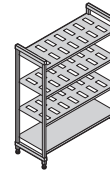

Add-On

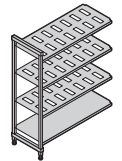

LENGTH	CODE	LIST PRICE EA.
24"	ESU182464VS4	\$ 445.00
30"	ESU183064VS4	455.00
36"	ESU183664VS4	500.00
42"	ESU184264VS4	560.00
48"	ESU184864VS4	585.00
54"	ESU185464VS4	645.00
60"	ESU186064VS4	690.00
72"	ESU187264VS4	770.00

LENGTH	CODE	LIST PRICE EA.
22"	EA182464VS4	\$ 355.00
28"	EA183064VS4	365.00
34"	EA183664VS4	410.00
40"	EA184264VS4	470.00
46"	EA184864VS4	495.00
52"	EA185464VS4	555.00
58"	EA186064VS4	595.00
70"	EA187264VS4	680.00

21"

DEPTH

24"	ESU212464S4	\$ 490.00
30"	ESU213064S4	505.00
36"	ESU213664S4	560.00
42"	ESU214264S4	630.00
48"	ESU214864S4	665.00
54"	ESU215464S4	735.00
60"	ESU216064S4	785.00
72"	ESU217264S4	885.00

22"	EA212464S4	\$ 395.00
28"	EA213064S4	415.00
34"	EA213664S4	470.00
40"	EA214264S4	540.00
46"	EA214864S4	570.00
52"	EA215464S4	640.00
58"	EA216064S4	690.00
70"	EA217264S4	795.00

24"	ESU212464VS4	\$ 475.00
30"	ESU213064VS4	495.00
36"	ESU213664VS4	545.00
42"	ESU214264VS4	615.00
48"	ESU214864VS4	645.00
54"	ESU215464VS4	715.00
60"	ESU216064VS4	760.00
72"	ESU217264VS4	860.00

22"	EA212464VS4	\$ 385.00
28"	EA213064VS4	400.00
34"	EA213664VS4	455.00
40"	EA214264VS4	525.00
46"	EA214864VS4	550.00
52"	EA215464VS4	620.00
58"	EA216064VS4	670.00
70"	EA217264VS4	765.00

24"

DEPTH

24"	ESU242464S4	\$ 495.00
30"	ESU243064S4	530.00
36"	ESU243664S4	585.00
42"	ESU244264S4	645.00
48"	ESU244864S4	690.00
54"	ESU245464S4	750.00
60"	ESU246064S4	800.00
72"	ESU247264S4	905.00

22"	EA242464S4	\$ 405.00
28"	EA243064S4	435.00
34"	EA243664S4	490.00
40"	EA244264S4	550.00
46"	EA244864S4	595.00
52"	EA245464S4	660.00
58"	EA246064S4	705.00
70"	EA247264S4	810.00

24"	ESU242464VS4	\$ 490.00
30"	ESU243064VS4	515.00
36"	ESU243664VS4	565.00
42"	ESU244264VS4	625.00
48"	ESU244864VS4	665.00
54"	ESU245464VS4	725.00
60"	ESU246064VS4	770.00
72"	ESU247264VS4	870.00

22"	EA242464VS4	\$ 395.00
28"	EA243064VS4	420.00
34"	EA243664VS4	470.00
40"	EA244264VS4	530.00
46"	EA244864VS4	570.00
52"	EA245464VS4	630.00
58"	EA246064VS4	675.00
70"	EA247264VS4	775.00

Color: Brushed Graphite (580).

V4

4-Shelf Vented Stationary Starter and Add-On Units

V5

5-Shelf Vented Stationary Starter and Add-On Units

Units ship complete in 1 box and include 1 or 2 factory assembled post kits, traverses, dovetails and shelf plates.

72"
HEIGHT

18"
DEPTH

Starter

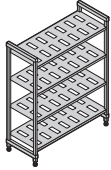

Add-On

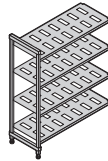

LENGTH	CODE	LIST PRICE EA.
24"	ESU182472V4	\$ 440.00
30"	ESU183072V4	455.00
36"	ESU183672V4	500.00
42"	ESU184272V4	560.00
48"	ESU184872V4	585.00
54"	ESU185472V4	645.00
60"	ESU186072V4	685.00
72"	ESU187272V4	765.00

LENGTH	CODE	LIST PRICE EA.
22"	EA182472V4	\$ 350.00
28"	EA183072V4	365.00
34"	EA183672V4	405.00
40"	EA184272V4	470.00
46"	EA184872V4	490.00
52"	EA185472V4	550.00
58"	EA186072V4	590.00
70"	EA187272V4	675.00

Starter

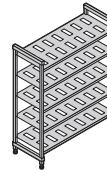

Add-On

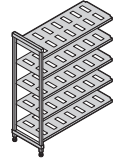

LENGTH	CODE	LIST PRICE EA.
24"	ESU182472V5	\$ 505.00
30"	ESU183072V5	525.00
36"	ESU183672V5	580.00
42"	ESU184272V5	655.00
48"	ESU184872V5	685.00
54"	ESU185472V5	760.00
60"	ESU186072V5	810.00
72"	ESU187272V5	910.00

LENGTH	CODE	LIST PRICE EA.
22"	EA182472V5	\$ 415.00
28"	EA183072V5	430.00
34"	EA183672V5	485.00
40"	EA184272V5	560.00
46"	EA184872V5	590.00
52"	EA185472V5	665.00
58"	EA186072V5	715.00
70"	EA187272V5	820.00

21"
DEPTH

LENGTH	CODE	LIST PRICE EA.
24"	ESU212472V4	\$ 475.00
30"	ESU213072V4	495.00
36"	ESU213672V4	545.00
42"	ESU214272V4	615.00
48"	ESU214872V4	640.00
54"	ESU215472V4	710.00
60"	ESU216072V4	755.00
72"	ESU217272V4	850.00

LENGTH	CODE	LIST PRICE EA.
22"	EA212472V4	\$ 380.00
28"	EA213072V4	400.00
34"	EA213672V4	450.00
40"	EA214272V4	520.00
46"	EA214872V4	545.00
52"	EA215472V4	615.00
58"	EA216072V4	660.00
70"	EA217272V4	755.00

LENGTH	CODE	LIST PRICE EA.
24"	ESU212472V5	\$ 550.00
30"	ESU213072V5	570.00
36"	ESU213672V5	635.00
42"	ESU214272V5	720.00
48"	ESU214872V5	755.00
54"	ESU215472V5	840.00
60"	ESU216072V5	900.00
72"	ESU217272V5	1,015.00

LENGTH	CODE	LIST PRICE EA.
22"	EA212472V5	\$ 455.00
28"	EA213072V5	475.00
34"	EA213672V5	540.00
40"	EA214272V5	625.00
46"	EA214872V5	660.00
52"	EA215472V5	745.00
58"	EA216072V5	805.00
70"	EA217272V5	920.00

24"
DEPTH

LENGTH	CODE	LIST PRICE EA.
24"	ESU242472V4	\$ 490.00
30"	ESU243072V4	515.00
36"	ESU243672V4	560.00
42"	ESU244272V4	620.00
48"	ESU244872V4	665.00
54"	ESU245472V4	720.00
60"	ESU246072V4	765.00
72"	ESU247272V4	865.00

LENGTH	CODE	LIST PRICE EA.
22"	EA242472V4	\$ 390.00
28"	EA243072V4	420.00
34"	EA243672V4	465.00
40"	EA244272V4	525.00
46"	EA244872V4	565.00
52"	EA245472V4	625.00
58"	EA246072V4	665.00
70"	EA247272V4	770.00

LENGTH	CODE	LIST PRICE EA.
24"	ESU242472V5	\$ 565.00
30"	ESU243072V5	595.00
36"	ESU243672V5	655.00
42"	ESU244272V5	730.00
48"	ESU244872V5	780.00
54"	ESU245472V5	850.00
60"	ESU246072V5	905.00
72"	ESU247272V5	1,030.00

LENGTH	CODE	LIST PRICE EA.
22"	EA242472V5	\$ 465.00
28"	EA243072V5	500.00
34"	EA243672V5	555.00
40"	EA244272V5	635.00
46"	EA244872V5	685.00
52"	EA245472V5	755.00
58"	EA246072V5	810.00
70"	EA247272V5	935.00

Color: Brushed Graphite (580).

S4

4-Shelf Solid Stationary Starter and Add-On Units

VS4

4-Shelf Vented and Solid Stationary Starter and Add-On Units

(3 Vented + 1 Solid)

Units ship complete in 1 box and include 1 or 2 factory assembled post kits, traverses, dovetails and shelf plates.

72"
HEIGHT

Starter

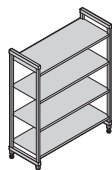

Add-On

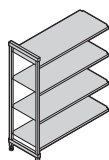

Starter

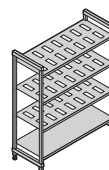

Add-On

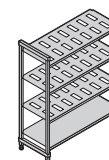

18"
DEPTH

LENGTH	CODE	LIST PRICE EA.
24"	ESU182472S4	\$ 465.00
30"	ESU183072S4	470.00
36"	ESU183672S4	515.00
42"	ESU184272S4	580.00
48"	ESU184872S4	600.00
54"	ESU185472S4	665.00
60"	ESU186072S4	710.00
72"	ESU187272S4	795.00

LENGTH	CODE	LIST PRICE EA.
22"	EA182472S4	\$ 375.00
28"	EA183072S4	375.00
34"	EA183672S4	420.00
40"	EA184272S4	485.00
46"	EA184872S4	510.00
52"	EA185472S4	575.00
58"	EA186072S4	620.00
70"	EA187272S4	705.00

LENGTH	CODE	LIST PRICE EA.
24"	ESU182472VS4	\$ 450.00
30"	ESU183072VS4	460.00
36"	ESU183672VS4	505.00
42"	ESU184272VS4	565.00
48"	ESU184872VS4	590.00
54"	ESU185472VS4	650.00
60"	ESU186072VS4	690.00
72"	ESU187272VS4	775.00

LENGTH	CODE	LIST PRICE EA.
22"	EA182472VS4	\$ 355.00
28"	EA183072VS4	365.00
34"	EA183672VS4	410.00
40"	EA184272VS4	475.00
46"	EA184872VS4	495.00
52"	EA185472VS4	555.00
58"	EA186072VS4	600.00
70"	EA187272VS4	680.00

21"
DEPTH

24"	ESU212472S4	\$ 490.00
30"	ESU213072S4	510.00
36"	ESU213672S4	565.00
42"	ESU214272S4	635.00
48"	ESU214872S4	670.00
54"	ESU215472S4	740.00
60"	ESU216072S4	790.00
72"	ESU217272S4	890.00

22"	EA212472S4	\$ 395.00
28"	EA213072S4	415.00
34"	EA213672S4	470.00
40"	EA214272S4	540.00
46"	EA214872S4	575.00
52"	EA215472S4	645.00
58"	EA216072S4	695.00
70"	EA217272S4	795.00

24"	ESU212472VS4	\$ 480.00
30"	ESU213072VS4	500.00
36"	ESU213672VS4	550.00
42"	ESU214272VS4	620.00
48"	ESU214872VS4	650.00
54"	ESU215472VS4	715.00
60"	ESU216072VS4	765.00
72"	ESU217272VS4	860.00

22"	EA212472VS4	\$ 385.00
28"	EA213072VS4	405.00
34"	EA213672VS4	455.00
40"	EA214272VS4	525.00
46"	EA214872VS4	555.00
52"	EA215472VS4	620.00
58"	EA216072VS4	670.00
70"	EA217272VS4	765.00

24"
DEPTH

24"	ESU242472S4	\$ 500.00
30"	ESU243072S4	535.00
36"	ESU243672S4	585.00
42"	ESU244272S4	650.00
48"	ESU244872S4	695.00
54"	ESU245472S4	755.00
60"	ESU246072S4	805.00
72"	ESU247272S4	910.00

22"	EA242472S4	\$ 405.00
28"	EA243072S4	435.00
34"	EA243672S4	490.00
40"	EA244272S4	555.00
46"	EA244872S4	595.00
52"	EA245472S4	660.00
58"	EA246072S4	710.00
70"	EA247272S4	815.00

24"	ESU242472VS4	\$ 490.00
30"	ESU243072VS4	520.00
36"	ESU243672VS4	565.00
42"	ESU244272VS4	630.00
48"	ESU244872VS4	670.00
54"	ESU245472VS4	730.00
60"	ESU246072VS4	775.00
72"	ESU247272VS4	875.00

22"	EA242472VS4	\$ 395.00
28"	EA243072VS4	425.00
34"	EA243672VS4	470.00
40"	EA244272VS4	535.00
46"	EA244872VS4	575.00
52"	EA245472VS4	635.00
58"	EA246072VS4	675.00
70"	EA247272VS4	780.00

Color: Brushed Graphite (580).

V4

4-Shelf Vented Stationary Starter and Add-On Units

V5

5-Shelf Vented Stationary Starter and Add-On Units

Units ship complete in 1 box and include 1 or 2 factory assembled post kits, traverses, dovetails and shelf plates.

84"
HEIGHT

18"
DEPTH

Starter

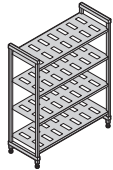

Add-On

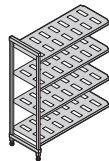

LENGTH	CODE	LIST PRICE EA.
24"	ESU182484V4	\$ 470.00
30"	ESU183084V4	485.00
36"	ESU183684V4	530.00
42"	ESU184284V4	590.00
48"	ESU184884V4	610.00
54"	ESU185484V4	675.00
60"	ESU186084V4	715.00
72"	ESU187284V4	795.00

LENGTH	CODE	LIST PRICE EA.
22"	EA182484V4	\$ 365.00
28"	EA183084V4	375.00
34"	EA183684V4	420.00
40"	EA184284V4	485.00
46"	EA184884V4	505.00
52"	EA185484V4	565.00
58"	EA186084V4	605.00
70"	EA187284V4	690.00

Starter

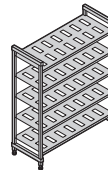

Add-On

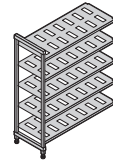

LENGTH	CODE	LIST PRICE EA.
24"	ESU182484V5	\$ 535.00
30"	ESU183084V5	550.00
36"	ESU183684V5	610.00
42"	ESU184284V5	685.00
48"	ESU184884V5	710.00
54"	ESU185484V5	785.00
60"	ESU186084V5	840.00
72"	ESU187284V5	940.00

LENGTH	CODE	LIST PRICE EA.
22"	EA182484V5	\$ 425.00
28"	EA183084V5	445.00
34"	EA183684V5	500.00
40"	EA184284V5	575.00
46"	EA184884V5	605.00
52"	EA185484V5	680.00
58"	EA186084V5	730.00
70"	EA187284V5	835.00

21"
DEPTH

LENGTH	CODE	LIST PRICE EA.
24"	ESU212484V4	\$ 505.00
30"	ESU213084V4	525.00
36"	ESU213684V4	575.00
42"	ESU214284V4	645.00
48"	ESU214884V4	670.00
54"	ESU215484V4	740.00
60"	ESU216084V4	785.00
72"	ESU217284V4	880.00

LENGTH	CODE	LIST PRICE EA.
22"	EA212484V4	\$ 395.00
28"	EA213084V4	415.00
34"	EA213684V4	465.00
40"	EA214284V4	535.00
46"	EA214884V4	560.00
52"	EA215484V4	630.00
58"	EA216084V4	675.00
70"	EA217284V4	770.00

LENGTH	CODE	LIST PRICE EA.
24"	ESU212484V5	\$ 575.00
30"	ESU213084V5	600.00
36"	ESU213684V5	665.00
42"	ESU214284V5	750.00
48"	ESU214884V5	780.00
54"	ESU215484V5	870.00
60"	ESU216084V5	930.00
72"	ESU217284V5	1,045.00

LENGTH	CODE	LIST PRICE EA.
22"	EA212484V5	\$ 465.00
28"	EA213084V5	490.00
34"	EA213684V5	555.00
40"	EA214284V5	640.00
46"	EA214884V5	675.00
52"	EA215484V5	760.00
58"	EA216084V5	820.00
70"	EA217284V5	935.00

24"
DEPTH

LENGTH	CODE	LIST PRICE EA.
24"	ESU242484V4	\$ 515.00
30"	ESU243084V4	545.00
36"	ESU243684V4	561.40
42"	ESU244284V4	620.20
48"	ESU244884V4	658.60
54"	ESU245484V4	713.40
60"	ESU246084V4	754.20
72"	ESU247284V4	895.00

LENGTH	CODE	LIST PRICE EA.
22"	EA242484V4	\$ 405.00
28"	EA243084V4	435.00
34"	EA243684V4	456.10
40"	EA244284V4	514.90
46"	EA244884V4	553.30
52"	EA245484V4	608.10
58"	EA246084V4	648.90
70"	EA247284V4	785.00

LENGTH	CODE	LIST PRICE EA.
24"	ESU242484V5	\$ 590.00
30"	ESU243084V5	625.00
36"	ESU243684V5	680.00
42"	ESU244284V5	760.00
48"	ESU244884V5	810.00
54"	ESU245484V5	880.00
60"	ESU246084V5	935.00
72"	ESU247284V5	1,060.00

LENGTH	CODE	LIST PRICE EA.
22"	EA242484V5	\$ 480.00
28"	EA243084V5	515.00
34"	EA243684V5	570.00
40"	EA244284V5	650.00
46"	EA244884V5	700.00
52"	EA245484V5	770.00
58"	EA246084V5	825.00
70"	EA247284V5	950.00

Color: Brushed Graphite (580).

S4

4-Shelf Solid Stationary Starter and Add-On Units

S5

5-Shelf Solid Stationary Starter and Add-On Units

Units ship complete in 1 box and include 1 or 2 factory assembled post kits, traverses, dovetails and shelf plates.

84"

HEIGHT

Starter

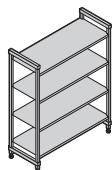

Add-On

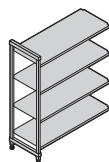

18"

DEPTH

LENGTH	CODE	LIST PRICE EA.
24"	ESU182484S4	\$ 495.00
30"	ESU183084S4	495.00
36"	ESU183684S4	545.00
42"	ESU184284S4	610.00
48"	ESU184884S4	630.00
54"	ESU185484S4	695.00
60"	ESU186084S4	740.00
72"	ESU187284S4	825.00

LENGTH	CODE	LIST PRICE EA.
22"	EA182484S4	\$ 390.00
28"	EA183084S4	390.00
34"	EA183684S4	435.00
40"	EA184284S4	500.00
46"	EA184884S4	525.00
52"	EA185484S4	590.00
58"	EA186084S4	635.00
70"	EA187284S4	720.00

Starter

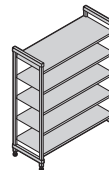

Add-On

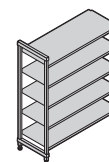

LENGTH	CODE	LIST PRICE EA.
24"	ESU182484S5	\$ 565.00
30"	ESU183084S5	565.00
36"	ESU183684S5	625.00
42"	ESU184284S5	710.00
48"	ESU184884S5	735.00
54"	ESU185484S5	815.00
60"	ESU186084S5	875.00
72"	ESU187284S5	980.00

LENGTH	CODE	LIST PRICE EA.
22"	EA182484S5	\$ 455.00
28"	EA183084S5	460.00
34"	EA183684S5	520.00
40"	EA184284S5	600.00
46"	EA184884S5	625.00
52"	EA185484S5	710.00
58"	EA186084S5	765.00
70"	EA187284S5	870.00

21"

DEPTH

24"	ESU212484S4	\$ 520.00
30"	ESU213084S4	540.00
36"	ESU213684S4	595.00
42"	ESU214284S4	665.00
48"	ESU214884S4	700.00
54"	ESU215484S4	770.00
60"	ESU216084S4	815.00
72"	ESU217284S4	920.00

22"	EA212484S4	\$ 410.00
28"	EA213084S4	430.00
34"	EA213684S4	485.00
40"	EA214284S4	555.00
46"	EA214884S4	590.00
52"	EA215484S4	660.00
58"	EA216084S4	705.00
70"	EA217284S4	810.00

24"	ESU212484S5	\$ 595.00
30"	ESU213084S5	620.00
36"	ESU213684S5	690.00
42"	ESU214284S5	775.00
48"	ESU214884S5	820.00
54"	ESU215484S5	905.00
60"	ESU216084S5	965.00
72"	ESU217284S5	1,095.00

22"	EA212484S5	\$ 485.00
28"	EA213084S5	510.00
34"	EA213684S5	580.00
40"	EA214284S5	665.00
46"	EA214884S5	710.00
52"	EA215484S5	795.00
58"	EA216084S5	855.00
70"	EA217284S5	985.00

24"

DEPTH

24"	ESU242484S4	\$ 530.00
30"	ESU243084S4	560.00
36"	ESU243684S4	615.00
42"	ESU244284S4	680.00
48"	ESU244884S4	720.00
54"	ESU245484S4	785.00
60"	ESU246084S4	835.00
72"	ESU247284S4	940.00

22"	EA242484S4	\$ 420.00
28"	EA243084S4	450.00
34"	EA243684S4	505.00
40"	EA244284S4	570.00
46"	EA244884S4	610.00
52"	EA245484S4	675.00
58"	EA246084S4	720.00
70"	EA247284S4	830.00

24"	ESU242484S5	\$ 605.00
30"	ESU243084S5	645.00
36"	ESU243684S5	715.00
42"	ESU244284S5	795.00
48"	ESU244884S5	845.00
54"	ESU245484S5	925.00
60"	ESU246084S5	985.00
72"	ESU247284S5	1,115.00

22"	EA242484S5	\$ 495.00
28"	EA243084S5	535.00
34"	EA243684S5	605.00
40"	EA244284S5	680.00
46"	EA244884S5	735.00
52"	EA245484S5	815.00
58"	EA246084S5	875.00
70"	EA247284S5	1,005.00

Color: Brushed Graphite (580).

VS4

4-Shelf Vented and Solid Stationary Starter and Add-On Units

(3 vented + 1 solid)

VS5

5-Shelf Vented and Solid Stationary Starter and Add-On Units

(4 vented + 1 solid)

Units ship complete in 1 box and include 1 or 2 factory assembled post kits, traverses, dovetails and shelf plates.

84"
HEIGHT

18"
DEPTH

Starter

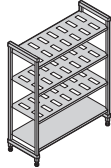

Add-On

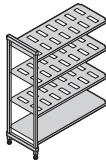

LENGTH	CODE	LIST PRICE EA.
24"	ESU182484VS4	\$ 475.00
30"	ESU183084VS4	490.00
36"	ESU183684VS4	535.00
42"	ESU184284VS4	595.00
48"	ESU184884VS4	615.00
54"	ESU185484VS4	680.00
60"	ESU186084VS4	720.00
72"	ESU187284VS4	805.00

LENGTH	CODE	LIST PRICE EA.
22"	EA182484VS4	\$ 370.00
28"	EA183084VS4	380.00
34"	EA183684VS4	425.00
40"	EA184284VS4	490.00
46"	EA184884VS4	510.00
52"	EA185484VS4	570.00
58"	EA186084VS4	615.00
70"	EA187284VS4	695.00

Starter

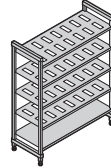

Add-On

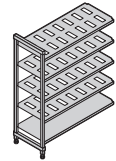

LENGTH	CODE	LIST PRICE EA.
24"	ESU182484VS5	\$ 540.00
30"	ESU183084VS5	555.00
36"	ESU183684VS5	610.00
42"	ESU184284VS5	690.00
48"	ESU184884VS5	715.00
54"	ESU185484VS5	795.00
60"	ESU186084VS5	845.00
72"	ESU187284VS5	950.00

LENGTH	CODE	LIST PRICE EA.
22"	EA182484VS5	\$ 435.00
28"	EA183084VS5	445.00
34"	EA183684VS5	505.00
40"	EA184284VS5	580.00
46"	EA184884VS5	610.00
52"	EA185484VS5	685.00
58"	EA186084VS5	740.00
70"	EA187284VS5	840.00

21"
DEPTH

24"	ESU212484VS4	\$ 510.00
30"	ESU213084VS4	525.00
36"	ESU213684VS4	580.00
42"	ESU214284VS4	650.00
48"	ESU214884VS4	675.00
54"	ESU215484VS4	745.00
60"	ESU216084VS4	795.00
72"	ESU217284VS4	890.00

22"	EA212484VS4	\$ 400.00
28"	EA213084VS4	415.00
34"	EA213684VS4	470.00
40"	EA214284VS4	540.00
46"	EA214884VS4	565.00
52"	EA215484VS4	635.00
58"	EA216084VS4	685.00
70"	EA217284VS4	780.00

24"	ESU212484VS5	\$ 580.00
30"	ESU213084VS5	605.00
36"	ESU213684VS5	670.00
42"	ESU214284VS5	755.00
48"	ESU214884VS5	790.00
54"	ESU215484VS5	875.00
60"	ESU216084VS5	935.00
72"	ESU217284VS5	1,055.00

22"	EA212484VS5	\$ 470.00
28"	EA213084VS5	495.00
34"	EA213684VS5	560.00
40"	EA214284VS5	645.00
46"	EA214884VS5	680.00
52"	EA215484VS5	765.00
58"	EA216084VS5	825.00
70"	EA217284VS5	945.00

24"
DEPTH

24"	ESU242484VS4	\$ 520.00
30"	ESU243084VS4	550.00
36"	ESU243684VS4	595.00
42"	ESU244284VS4	660.00
48"	ESU244884VS4	700.00
54"	ESU245484VS4	760.00
60"	ESU246084VS4	800.00
72"	ESU247284VS4	905.00

22"	EA242484VS4	\$ 410.00
28"	EA243084VS4	440.00
34"	EA243684VS4	485.00
40"	EA244284VS4	545.00
46"	EA244884VS4	590.00
52"	EA245484VS4	650.00
58"	EA246084VS4	690.00
70"	EA247284VS4	795.00

24"	ESU242484VS5	\$ 595.00
30"	ESU243084VS5	630.00
36"	ESU243684VS5	690.00
42"	ESU244284VS5	765.00
48"	ESU244884VS5	815.00
54"	ESU245484VS5	890.00
60"	ESU246084VS5	945.00
72"	ESU247284VS5	1,070.00

22"	EA242484VS5	\$ 485.00
28"	EA243084VS5	520.00
34"	EA243684VS5	580.00
40"	EA244284VS5	655.00
46"	EA244884VS5	705.00
52"	EA245484VS5	780.00
58"	EA246084VS5	835.00
70"	EA247284VS5	960.00

Color: Brushed Graphite (580).

V4 4-Shelf Vented Mobile Starter Units

V5 5-Shelf Vented Mobile Starter Units

Units ship complete in 1 box and include 1 or 2 factory assembled mobile post kits, traverses, dovetails, shelf plates and 4 swivel, total locking casters.

70¼"

HEIGHT includes 5" casters.

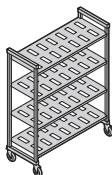

18" DEPTH

CODE	DIMENSIONS D x L x H	LIST PRICE EA.
EMU183670V4	18" x 36" x 70¼"	\$ 780.00
EMU184270V4	18" x 42" x 70¼"	840.00
EMU184870V4	18" x 48" x 70¼"	860.00
EMU185470V4	18" x 54" x 70¼"	920.00
EMU186070V4	18" x 60" x 70¼"	965.00

21" DEPTH

EMU213670V4	21" x 36" x 70¼"	\$ 825.00
EMU214270V4	21" x 42" x 70¼"	890.00
EMU214870V4	21" x 48" x 70¼"	920.00
EMU215470V4	21" x 54" x 70¼"	985.00
EMU216070V4	21" x 60" x 70¼"	1,035.00

24" DEPTH

EMU243670V4	24" x 36" x 70¼"	\$ 840.00
EMU244270V4	24" x 42" x 70¼"	900.00
EMU244870V4	24" x 48" x 70¼"	940.00
EMU245470V4	24" x 54" x 70¼"	1,000.00
EMU246070V4	24" x 60" x 70¼"	1,040.00

78¼"

HEIGHT includes 5" casters.

18" DEPTH

CODE	DIMENSIONS D x L x H	LIST PRICE EA.
EMU183678V4	18" x 36" x 78¼"	\$ 780.00
EMU184278V4	18" x 42" x 78¼"	845.00
EMU184878V4	18" x 48" x 78¼"	865.00
EMU185478V4	18" x 54" x 78¼"	925.00
EMU186078V4	18" x 60" x 78¼"	965.00

21" DEPTH

EMU213678V4	21" x 36" x 78¼"	\$ 825.00
EMU214278V4	21" x 42" x 78¼"	895.00
EMU214878V4	21" x 48" x 78¼"	925.00
EMU215478V4	21" x 54" x 78¼"	990.00
EMU216078V4	21" x 60" x 78¼"	1,040.00

24" DEPTH

EMU243678V4	24" x 36" x 78¼"	\$ 840.00
EMU244278V4	24" x 42" x 78¼"	905.00
EMU244878V4	24" x 48" x 78¼"	945.00
EMU245478V4	24" x 54" x 78¼"	1,000.00
EMU246078V4	24" x 60" x 78¼"	1,045.00

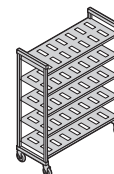

18" DEPTH

CODE	DIMENSIONS D x L x H	LIST PRICE EA.
EMU183670V5	18" x 36" x 70¼"	\$ 865.00
EMU184270V5	18" x 42" x 70¼"	940.00
EMU184870V5	18" x 48" x 70¼"	965.00
EMU185470V5	18" x 54" x 70¼"	1,045.00
EMU186070V5	18" x 60" x 70¼"	1,095.00

21" DEPTH

EMU213670V5	21" x 36" x 70¼"	\$ 920.00
EMU214270V5	21" x 42" x 70¼"	1,005.00
EMU214870V5	21" x 48" x 70¼"	1,040.00
EMU215470V5	21" x 54" x 70¼"	1,125.00
EMU216070V5	21" x 60" x 70¼"	1,185.00

24" DEPTH

EMU243670V5	24" x 36" x 70¼"	\$ 940.00
EMU244270V5	24" x 42" x 70¼"	1,015.00
EMU244870V5	24" x 48" x 70¼"	1,065.00
EMU245470V5	24" x 54" x 70¼"	1,135.00
EMU246070V5	24" x 60" x 70¼"	1,190.00

18" DEPTH

CODE	DIMENSIONS D x L x H	LIST PRICE EA.
EMU183678V5	18" x 36" x 78¼"	\$ 870.00
EMU184278V5	18" x 42" x 78¼"	945.00
EMU184878V5	18" x 48" x 78¼"	970.00
EMU185478V5	18" x 54" x 78¼"	1,045.00
EMU186078V5	18" x 60" x 78¼"	1,100.00

21" DEPTH

EMU213678V5	21" x 36" x 78¼"	\$ 925.00
EMU214278V5	21" x 42" x 78¼"	1,010.00
EMU214878V5	21" x 48" x 78¼"	1,045.00
EMU215478V5	21" x 54" x 78¼"	1,130.00
EMU216078V5	21" x 60" x 78¼"	1,190.00

24" DEPTH

EMU243678V5	24" x 36" x 78¼"	\$ 940.00
EMU244278V5	24" x 42" x 78¼"	1,020.00
EMU244878V5	24" x 48" x 78¼"	1,070.00
EMU245478V5	24" x 54" x 78¼"	1,140.00
EMU246078V5	24" x 60" x 78¼"	1,195.00



V2 2-Shelf Vented Undercounter Stationary Units

Stationary units include 2 factory assembled stationary post kits, 4 stationary traverses, stationary traverse dovetails and shelf plates. Units ship complete in 1 box.

30"
HEIGHT

18"
DEPTH

CODE	DIMENSIONS D x L	LIST PRICE EA.
ESU183630V2	18" x 36"	\$ 315.00
ESU184830V2	18" x 48"	355.00



V2 2-Shelf Vented Undercounter Mobile Units

Mobile units include 2 factory assembled mobile post kits, 4 mobile traverses, mobile traverse dovetails, shelf plates, and 4 premium swivel casters with total locking brake. Units ship complete in 1 box.

27¼"
HEIGHT includes 5" casters.

14"
DEPTH

CODE	DIMENSIONS D x L	LIST PRICE EA.
EMU142427V2	14" x 24"	\$ 540.00
EMU143627V2	14" x 36"	605.00
EMU144827V2	14" x 48"	645.00



Standard Stationary Post Kits

Ships **unassembled** in 1 box. Includes 2 stationary posts, post connectors and post connector wedges.



30"
HEIGHT

CODE	DIMENSIONS D x H	LIST PRICE EA.
EPK1830	18" x 30"	\$ 80.40

Height is suitable for undercounter or table.



64"
HEIGHT

EPK1464	14" x 64"	\$ 86.95
EPK1864	18" x 64"	91.00
EPK2164	21" x 64"	93.35
EPK2464	24" x 64"	94.10

72"
HEIGHT

EPK1472	14" x 72"	\$ 88.95
EPK1872	18" x 72"	93.10
EPK2172	21" x 72"	95.35
EPK2472	24" x 72"	96.15

84"
HEIGHT

EPK1484	14" x 84"	\$ 103.00
EPK1884	18" x 84"	108.00
EPK2184	21" x 84"	110.00
EPK2484	24" x 84"	111.00

Color: Brushed Graphite (580).

V1

Stationary Single Vented Shelf Kits

Includes 2 stationary shelf traverses, stationary traverse dovetails and vented or solid shelf plates. Fits stationary units only. Ships in 1 box.

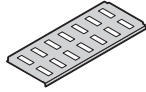

14"
DEPTH

CODE	DIMENSIONS D x L	LIST PRICE EA.
ESK1424V1	14" x 24"	\$ 63.55
ESK1430V1	14" x 30"	67.05
ESK1436V1	14" x 36"	77.05
ESK1442V1	14" x 42"	88.20
ESK1448V1	14" x 48"	97.65
ESK1454V1	14" x 54"	109.00
ESK1460V1	14" x 60"	117.00
ESK1472V1	14" x 72"	137.00

18"
DEPTH

ESK1824V1	18" x 24"	\$ 63.95
ESK1830V1	18" x 30"	67.35
ESK1836V1	18" x 36"	78.60
ESK1842V1	18" x 42"	93.80
ESK1848V1	18" x 48"	99.30
ESK1854V1	18" x 54"	114.00
ESK1860V1	18" x 60"	125.00
ESK1872V1	18" x 72"	145.00

21"
DEPTH

ESK2124V1	21" x 24"	\$ 71.50
ESK2130V1	21" x 30"	75.80
ESK2136V1	21" x 36"	88.80
ESK2142V1	21" x 42"	106.00
ESK2148V1	21" x 48"	113.00
ESK2154V1	21" x 54"	130.00
ESK2160V1	21" x 60"	142.00
ESK2172V1	21" x 72"	165.00

24"
DEPTH

ESK2424V1	24" x 24"	\$ 74.10
ESK2430V1	24" x 30"	80.80
ESK2436V1	24" x 36"	92.10
ESK2442V1	24" x 42"	108.00
ESK2448V1	24" x 48"	118.00
ESK2454V1	24" x 54"	132.00
ESK2460V1	24" x 60"	143.00
ESK2472V1	24" x 72"	168.00

S1

Stationary Single Solid Shelf Kits

Includes 2 stationary shelf traverses, stationary traverse dovetails and vented or solid shelf plates. Fits stationary units only. Ships in 1 box.

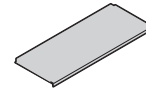

14"
DEPTH

CODE	DIMENSIONS D x L	LIST PRICE EA.
ESK1424S1	14" x 24"	\$ 64.70
ESK1430S1	14" x 30"	68.40
ESK1436S1	14" x 36"	79.10
ESK1442S1	14" x 42"	91.10
ESK1448S1	14" x 48"	100.45
ESK1454S1	14" x 54"	112.00
ESK1460S1	14" x 60"	121.00
ESK1472S1	14" x 72"	142.00

18"
DEPTH

ESK1824S1	18" x 24"	\$ 70.00
ESK1830S1	18" x 30"	70.35
ESK1836S1	18" x 36"	82.25
ESK1842S1	18" x 42"	98.55
ESK1848S1	18" x 48"	104.00
ESK1854S1	18" x 54"	120.00
ESK1860S1	18" x 60"	132.00
ESK1872S1	18" x 72"	153.00

21"
DEPTH

ESK2124S1	21" x 24"	\$ 75.25
ESK2130S1	21" x 30"	79.90
ESK2136S1	21" x 36"	93.60
ESK2142S1	21" x 42"	111.00
ESK2148S1	21" x 48"	120.00
ESK2154S1	21" x 54"	137.00
ESK2160S1	21" x 60"	149.00
ESK2172S1	21" x 72"	175.00

24"
DEPTH

ESK2424S1	24" x 24"	\$ 77.25
ESK2430S1	24" x 30"	85.25
ESK2436S1	24" x 36"	98.75
ESK2442S1	24" x 42"	114.00
ESK2448S1	24" x 48"	125.00
ESK2454S1	24" x 54"	141.00
ESK2460S1	24" x 60"	153.00
ESK2472S1	24" x 72"	179.00

V4 Stationary 4-Shelf Vented Kits

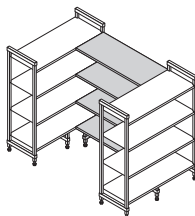

Includes 8 stationary shelf traverses, stationary traverse dovetails and vented or solid shelf plates.
Ships in 1 box. Fits stationary units only. Install with 8 sets of corner connectors (ECC8) to create a U-shape unit.

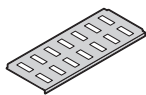

18"
DEPTH

CODE	DIMENSIONS D x L	LIST PRICE EA.
ESK1836V4	18" x 36"	\$ 315.00
ESK1842V4	18" x 42"	375.00
ESK1848V4	18" x 48"	395.00

21"
DEPTH

ESK2136V4	21" x 36"	\$ 355.00
ESK2142V4	21" x 42"	425.00
ESK2148V4	21" x 48"	450.00

24"
DEPTH

ESK2436V4	24" x 36"	\$ 370.00
ESK2442V4	24" x 42"	430.00
ESK2448V4	24" x 48"	470.00

S4 Stationary 4-Shelf Solid Kits

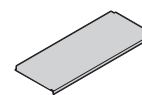

18"
DEPTH

CODE	DIMENSIONS D x L	LIST PRICE EA.
ESK1836S4	18" x 36"	\$ 330.00
ESK1842S4	18" x 42"	395.00
ESK1848S4	18" x 48"	415.00

21"
DEPTH

ESK2136S4	21" x 36"	\$ 375.00
ESK2142S4	21" x 42"	445.00
ESK2148S4	21" x 48"	480.00

24"
DEPTH

ESK2436S4	24" x 36"	\$ 395.00
ESK2442S4	24" x 42"	455.00
ESK2448S4	24" x 48"	500.00

V5 Stationary 5-Shelf Vented Kits

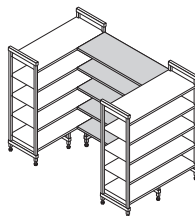

Includes 10 stationary shelf traverses, stationary traverse dovetails and vented or solid shelf plates.
Ships in 1 box. Fits stationary units only. Install with 10 sets of corner connectors (ECC10) to create a U-shape unit.

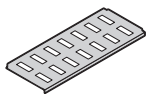

18"
DEPTH

CODE	DIMENSIONS D x L	LIST PRICE EA.
ESK1836V5	18" x 36"	\$ 395.00
ESK1842V5	18" x 42"	470.00
ESK1848V5	18" x 48"	495.00

21"
DEPTH

ESK2136V5	21" x 36"	\$ 445.00
ESK2142V5	21" x 42"	530.00
ESK2148V5	21" x 48"	565.00

24"
DEPTH

ESK2436V5	24" x 36"	\$ 460.00
ESK2442V5	24" x 42"	540.00
ESK2448V5	24" x 48"	590.00

S5 Stationary 5-Shelf Solid Kits

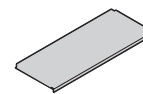

18"
DEPTH

CODE	DIMENSIONS D x L	LIST PRICE EA.
ESK1836S5	18" x 36"	\$ 410.00
ESK1842S5	18" x 42"	495.00
ESK1848S5	18" x 48"	520.00

21"
DEPTH

ESK2136S5	21" x 36"	\$ 470.00
ESK2142S5	21" x 42"	555.00
ESK2148S5	21" x 48"	600.00

24"
DEPTH

ESK2436S5	24" x 36"	\$ 495.00
ESK2442S5	24" x 42"	570.00
ESK2448S5	24" x 48"	625.00

VS4

Stationary 4-Shelf Kits

(3 Vented + 1 Solid)

Includes 8 stationary shelf traverses, stationary traverse dovetails and vented or solid shelf plates. Ships in 1 box.

Fits stationary units only. Install with 8 sets of corner connectors (ECC8) to create a U-shape unit.

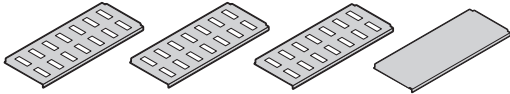

18"
DEPTH

CODE	DIMENSIONS D x L	LIST PRICE EA.
ESK1836VS4	18" x 36"	\$ 320.00
ESK1842VS4	18" x 42"	380.00
ESK1848VS4	18" x 48"	400.00

21"
DEPTH

ESK2136VS4	21" x 36"	\$ 360.00
ESK2142VS4	21" x 42"	430.00
ESK2148VS4	21" x 48"	455.00

24"
DEPTH

ESK2436VS4	24" x 36"	\$ 375.00
ESK2442VS4	24" x 42"	435.00
ESK2448VS4	24" x 48"	480.00

VS5

Stationary 5-Shelf Kits

(4 Vented + 1 Solid)

Includes 10 stationary shelf traverses, stationary traverse dovetails and vented or solid shelf plates. Ships in 1 box.

Fits stationary units only. Install with 10 sets of corner connectors (ECC10) to create a U-shape unit.

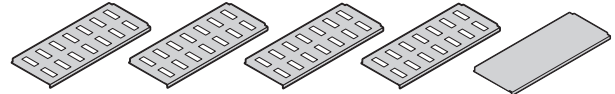

18"
DEPTH

CODE	DIMENSIONS D x L	LIST PRICE EA.
ESK1836VS5	18" x 36"	\$ 395.00
ESK1842VS5	18" x 42"	475.00
ESK1848VS5	18" x 48"	500.00

21"
DEPTH

ESK2136VS5	21" x 36"	\$ 450.00
ESK2142VS5	21" x 42"	535.00
ESK2148VS5	21" x 48"	570.00

24"
DEPTH

ESK2436VS5	24" x 36"	\$ 465.00
ESK2442VS5	24" x 42"	545.00
ESK2448VS5	24" x 48"	595.00

Color: Brushed Graphite (580).



Mobile Post Kits

Ships **unassembled** in 1 box. Includes 2 mobile posts, post connectors, post connector wedges and 2 swivel, total locking casters.

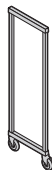

70¹/₄"
HEIGHT

CODE	DIMENSIONS D x L	LIST PRICE EA.
EMPK1870	18" x 70 ¹ / ₄ "	\$ 217.00
EMPK2170	21" x 70 ¹ / ₄ "	219.00
EMPK2470	24" x 70 ¹ / ₄ "	220.00

78¹/₄"
HEIGHT

EMPK1878	18" x 78 ¹ / ₄ "	\$ 219.00
EMPK2178	21" x 78 ¹ / ₄ "	221.00
EMPK2478	24" x 78 ¹ / ₄ "	222.00

Color: Brushed Graphite (580). HEIGHT includes 5" caster.

Donut Bumper

Offers added protection during transport and when maneuvering mobile units into place against walls or alongside other units for storage.

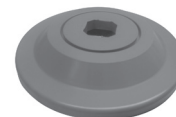

CODE	DIAMETER	LIST PRICE EA.
CSMHDBB	5"	\$ 25.00

Case Pack: 4 Color: Gray (000).

V1

Mobile Single Vented Shelf Kits

Includes 2 mobile shelf traverses, mobile traverse dovetails and vented shelf plates. Fits mobile units only. Ships in 1 box.

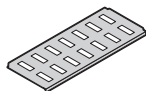

18"
DEPTH

CODE	DIMENSIONS D x L	LIST PRICE EA.
EMSK1836V1	18" x 36"	\$ 86.00
EMSK1842V1	18" x 42"	101.15
EMSK1848V1	18" x 48"	107.00
EMSK1854V1	18" x 54"	122.00
EMSK1860V1	18" x 60"	132.00

21"
DEPTH

EMSK2136V1	21" x 36"	\$ 96.15
EMSK2142V1	21" x 42"	113.00
EMSK2148V1	21" x 48"	120.00
EMSK2154V1	21" x 54"	137.00
EMSK2160V1	21" x 60"	149.00

24"
DEPTH

EMSK2436V1	24" x 36"	\$ 99.50
EMSK2442V1	24" x 42"	115.00
EMSK2448V1	24" x 48"	125.00
EMSK2454V1	24" x 54"	139.00
EMSK2460V1	24" x 60"	150.00

Color: Brushed Graphite (580).

S1

Mobile Single Solid Shelf Kits

Includes 2 mobile shelf traverses, mobile traverse dovetails and solid shelf plates. Fits mobile units only. Ships in 1 box.

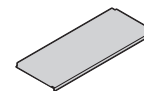

18"
DEPTH

CODE	DIMENSIONS D x L	LIST PRICE EA.
EMSK1836S1	18" x 36"	\$ 89.65
EMSK1842S1	18" x 42"	106.00
EMSK1848S1	18" x 48"	111.00
EMSK1854S1	18" x 54"	127.00
EMSK1860S1	18" x 60"	139.00

21"
DEPTH

EMSK2136S1	21" x 36"	\$ 101.00
EMSK2142S1	21" x 42"	119.00
EMSK2148S1	21" x 48"	127.00
EMSK2154S1	21" x 54"	145.00
EMSK2160S1	21" x 60"	157.00

24"
DEPTH

EMSK2436S1	24" x 36"	\$ 106.00
EMSK2442S1	24" x 42"	122.00
EMSK2448S1	24" x 48"	133.00
EMSK2454S1	24" x 54"	148.00
EMSK2460S1	24" x 60"	160.00

Corner Connectors

Unique patented design ensures maximum shelf space utilization. Use 1 set per shelf to connect starter and add-on units in corners. Connect 4 or 5 intermediate shelves between 2 starter units (2 sets required per shelf). Available as a single set or 8 or 10 set packs.

CODE	DESCRIPTION	LIST PRICE EA.
ECC1	1 Set for 1 shelf	\$ 6.25
ECC8	8 Sets for 4 shelves	50.00
ECC10	10 Sets for 5 shelves	62.50

Color: Brushed Graphite (580).

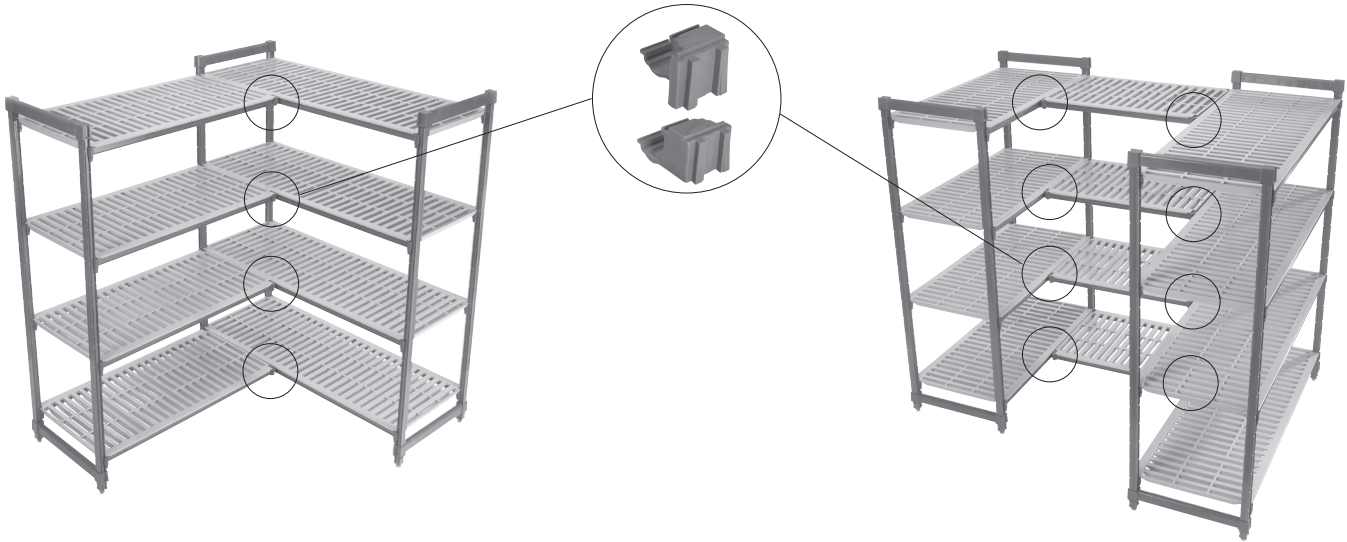

Bottom Shelf Dunnage Stands

Increase weight bearing capacity on bottom shelf only. Add to any shelf length. Highly recommended for starter units 54" and longer and all corner units, intermediate units and units specified for heavier load volume on and off bottom shelves.

CODE	DIMENSIONS D x H	LIST PRICE EA.
Dunnage Stand – Low (bottom shelf installed on lowest set of open post locations for dovetails)		
EDS14H6	14" x 6½"	\$ 55.45
EDS18H6	18" x 6½"	57.25
EDS21H6	21" x 6½"	58.75
EDS24H6	24" x 6½"	60.10
Dunnage Stand – Tall (bottom shelf installed up on 2nd set of open post locations for dovetails)		
EDS14H10	14" x 10½"	60.50
EDS18H10	18" x 10½"	62.25
EDS21H10	21" x 10½"	63.75
EDS24H10	24" x 10½"	65.15

Case Pack: 1 Color: Brushed Graphite (580).

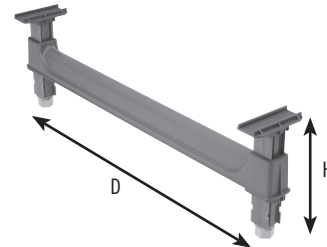
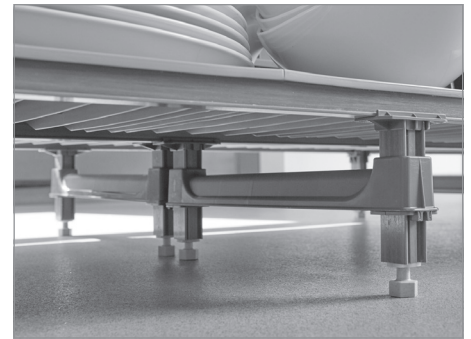

Bottom Shelf with Dunnage Stand

UNIT LENGTH	WEIGHT BEARING
Standard Unit	
24" - 48"	1,200 lbs.
54" - 72"	900
Corner Unit with 2 Dunnage Stands	
24" - 48"	600

Shelf Traverses

Available in single or double packs, stationary or mobile. Use two traverses to add an open shelf for divider bars or drying cradles. Add one stationary traverse onto back posts of a stationary unit for extra support when placing rolling equipment under the first shelf. Traverse dovetails included.

Stationary

LENGTH	SINGLE PACK CODE*	LIST PRICE EA.	DOUBLE PACK CODE**	LIST PRICE EA.
24"	ETR24	\$ 29.70	ETR242PK	\$ 56.60
30"	ETR30	32.15	ETR302PK	61.30
36"	ETR36	33.40	ETR362PK	63.75
42"	ETR42	35.70	ETR422PK	68.05
48"	ETR48	38.95	ETR482PK	74.25
54"	ETR54	42.20	ETR542PK	80.55
60"	ETR60	45.45	ETR602PK	86.85
72"	ETR72	52.00	—	—

*Case Pack: 1 **Case Pack: 2 Color: Brushed Graphite (580).

Mobile

LENGTH	SINGLE PACK CODE*	LIST PRICE EA.	DOUBLE PACK CODE**	LIST PRICE EA.
36"	EMTR36	\$ 45.70	EMTR362PK	\$ 72.45
42"	EMTR42	49.50	EMTR422PK	78.55
48"	EMTR48	53.30	EMTR482PK	84.55
54"	EMTR54	57.05	EMTR542PK	90.50
60"	EMTR60	60.90	EMTR602PK	96.60

*Case Pack: 1 **Case Pack: 2 Color: Brushed Graphite (580).

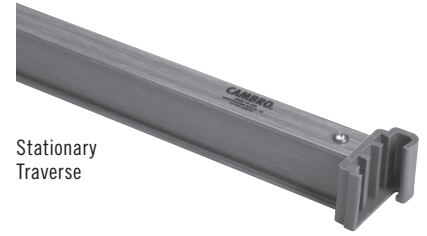

Stationary Traverse

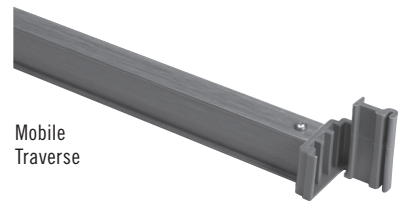

Mobile Traverse



CAMSHELVING

BASICS® PLUS

series

STATIONARY

WHY CHOOSE BASICS PLUS?

Just because the budget is tight and storage needs are less rigorous, it doesn't mean that shelving performance and storage efficiencies should be compromised. Basics Plus Series is made from the same high performing, strong composite material as Elements Series and has the same design features. It's lighter in weight and less in cost but still strong enough to handle light to medium storage demands.



camguard.

ANTIMICROBIAL SHELF PLATES



COMPONENT



Post Connectors, Corner Connectors, Floor Fastener, Wall Fastener, Shelf Rails, Single Shelf Security Cage, Shelf Divider Panels and Identification Tags are not NSF listed.

Stationary Unit Sizes

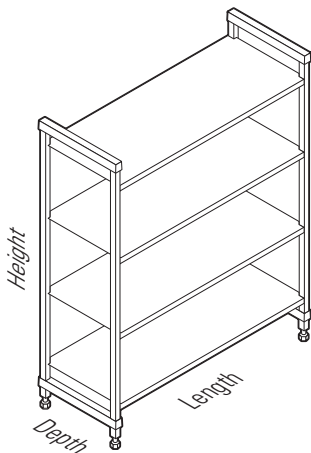

3 Depths		
18"	21"	24"
6 Lengths		
30"	36"	42"
48"	54"	60"
3 Heights		
64"	72"	84"



Weight Bearing Capacity

Weight must be evenly distributed across the entire shelf.

		UNIT LENGTH 30" – 48"	UNIT LENGTH 54" – 60"
SINGLE UNIT	Unit only	1,800 lbs.	1,800 lbs.
	Shelf only	700	500
	Unit with dunnage stand*	2,100	2,100
	Bottom shelf with dunnage stand*	1,000	800
CORNER UNIT** With 2 Dunnage Stands required	Unit only	1,350	—
	Shelf only	300	—
	Bottom shelf with dunnage stands*	450	—

*Dunnage Stands add stability and increase weight bearing capacity on bottom shelf only. Highly recommended for Starter Units 54" and longer, all Corner Units, U-Shape Units and units specified for heavier loads. (See Overall Length Quick Reference Guide).

**Corner connectors are for use only with shelves 30" - 48" long.



CAMSHELVING BASICS PLUS® SERIES – STARTER AND ADD-ON UNITS

V4 4-Shelf Vented Stationary Starter and Add-On Units

HEIGHTS	DEPTHS	LENGTHS	
3	3	6	
64"	18"	30"	48"
72"	21"	36"	54"
84"	24"	42"	60"

V5 5-Shelf Vented Stationary Starter and Add-On Units

HEIGHTS	DEPTHS	LENGTHS	
3	3	6	
64"	18"	30"	48"
72"	21"	36"	54"
84"	24"	42"	60"

S4 4-Shelf Solid Stationary Starter and Add-On Units

HEIGHTS	DEPTHS	LENGTHS	
3	3	6	
64"	18"	30"	48"
72"	21"	36"	54"
84"	24"	42"	60"

S5 5-Shelf Solid Stationary Starter and Add-On Units

HEIGHT	DEPTHS	LENGTHS	
1	3	6	
84"	18"	30"	48"
	21"	36"	54"
	24"	42"	60"

VS4 4-Shelf Vented and Solid Stationary Starter and Add-On Units (3 vented + 1 solid)

HEIGHTS	DEPTHS	LENGTHS	
3	3	6	
64"	18"	30"	48"
72"	21"	36"	54"
84"	24"	42"	60"

VS5 5-Shelf Vented and Solid Stationary Starter and Add-On Units (4 vented + 1 solid)

HEIGHT	DEPTHS	LENGTHS	
1	3	6	
84"	18"	30"	48"
	21"	36"	54"
	24"	42"	60"

V4

4-Shelf Vented Stationary Starter and Add-On Units

V5

5-Shelf Vented Stationary Starter and Add-On Units

Units ship complete in 1 box and include 1 or 2 factory assembled post kits, traverses, dovetails and shelf plates.

64"
HEIGHT

18"
DEPTH

Starter

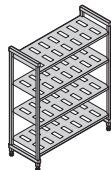

Add-On

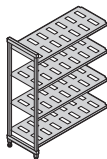

LENGTH	CODE	LIST PRICE EA.
30"	CBU183064V4	\$ 360.00
36"	CBU183664V4	395.00
42"	CBU184264V4	445.00
48"	CBU184864V4	465.00
54"	CBU185464V4	510.00
60"	CBU186064V4	545.00

LENGTH	CODE	LIST PRICE EA.
28¼"	CBA183064V4	\$ 289.00
34¼"	CBA183664V4	325.00
40¼"	CBA184264V4	375.00
46¼"	CBA184864V4	390.00
52¼"	CBA185464V4	440.00
58¼"	CBA186064V4	470.00

Starter

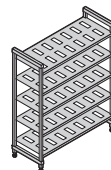

Add-On

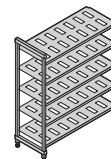

LENGTH	CODE	LIST PRICE EA.
30"	CBU183064V5	\$ 415.00
36"	CBU183664V5	460.00
42"	CBU184264V5	520.00
48"	CBU184864V5	545.00
54"	CBU185464V5	605.00
60"	CBU186064V5	645.00

LENGTH	CODE	LIST PRICE EA.
28¼"	CBA183064V5	\$ 345.00
34¼"	CBA183664V5	385.00
40¼"	CBA184264V5	450.00
46¼"	CBA184864V5	470.00
52¼"	CBA185464V5	530.00
58¼"	CBA186064V5	570.00

21"
DEPTH

30"	CBU213064V4	\$ 390.00
36"	CBU213664V4	435.00
42"	CBU214264V4	490.00
48"	CBU214864V4	510.00
54"	CBU215464V4	565.00
60"	CBU216064V4	605.00

28¼"	CBA213064V4	\$ 315.00
34¼"	CBA213664V4	360.00
40¼"	CBA214264V4	415.00
46¼"	CBA214864V4	435.00
52¼"	CBA215464V4	490.00
58¼"	CBA216064V4	530.00

30"	CBU213064V5	\$ 450.00
36"	CBU213664V5	505.00
42"	CBU214264V5	575.00
48"	CBU214864V5	600.00
54"	CBU215464V5	670.00
60"	CBU216064V5	715.00

28¼"	CBA213064V5	\$ 380.00
34¼"	CBA213664V5	430.00
40¼"	CBA214264V5	500.00
46¼"	CBA214864V5	525.00
52¼"	CBA215464V5	595.00
58¼"	CBA216064V5	640.00

24"
DEPTH

30"	CBU243064V4	\$ 410.00
36"	CBU243664V4	445.00
42"	CBU244264V4	495.00
48"	CBU244864V4	525.00
54"	CBU245464V4	575.00
60"	CBU246064V4	605.00

28¼"	CBA243064V4	\$ 335.00
34¼"	CBA243664V4	370.00
40¼"	CBA244264V4	420.00
46¼"	CBA244864V4	450.00
52¼"	CBA245464V4	500.00
58¼"	CBA246064V4	530.00

30"	CBU243064V5	\$ 475.00
36"	CBU243664V5	520.00
42"	CBU244264V5	580.00
48"	CBU244864V5	620.00
54"	CBU245464V5	680.00
60"	CBU246064V5	720.00

28¼"	CBA243064V5	\$ 400.00
34¼"	CBA243664V5	445.00
40¼"	CBA244264V5	505.00
46¼"	CBA244864V5	545.00
52¼"	CBA245464V5	605.00
58¼"	CBA246064V5	645.00

S4

4-Shelf Solid Stationary Starter and Add-On Units

VS4

4-Shelf Vented and Solid Stationary Starter and Add-On Units

(3 Vented + 1 Solid)

Units ship complete in 1 box and include 1 or 2 factory assembled post kits, traverses, dovetails and shelf plates.

64"
HEIGHT

Starter

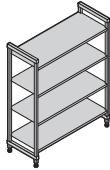

Add-On

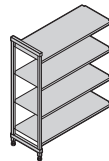

18"
DEPTH

LENGTH	CODE	LIST PRICE EA.
30"	CBU183064S4	\$ 370.00
36"	CBU183664S4	410.00
42"	CBU184264S4	460.00
48"	CBU184864S4	475.00
54"	CBU185464S4	530.00
60"	CBU186064S4	565.00

LENGTH	CODE	LIST PRICE EA.
28¼"	CBA183064S4	\$ 298.00
34¼"	CBA183664S4	335.00
40¼"	CBA184264S4	390.00
46¼"	CBA184864S4	405.00
52¼"	CBA185464S4	455.00
58¼"	CBA186064S4	495.00

Starter

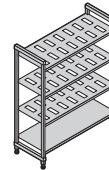

Add-On

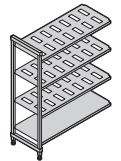

LENGTH	CODE	LIST PRICE EA.
30"	CBU183064VS4	\$ 365.00
36"	CBU183664VS4	400.00
42"	CBU184264VS4	450.00
48"	CBU184864VS4	465.00
54"	CBU185464VS4	515.00
60"	CBU186064VS4	550.00

LENGTH	CODE	LIST PRICE EA.
28¼"	CBA183064VS4	\$ 291.00
34¼"	CBA183664VS4	325.00
40¼"	CBA184264VS4	375.00
46¼"	CBA184864VS4	395.00
52¼"	CBA185464VS4	445.00
58¼"	CBA186064VS4	475.00

21"
DEPTH

30"	CBU213064S4	\$ 405.00
36"	CBU213664S4	450.00
42"	CBU214264S4	505.00
48"	CBU214864S4	530.00
54"	CBU215464S4	590.00
60"	CBU216064S4	625.00

28¼"	CBA213064S4	\$ 330.00
34¼"	CBA213664S4	375.00
40¼"	CBA214264S4	430.00
46¼"	CBA214864S4	455.00
52¼"	CBA215464S4	515.00
58¼"	CBA216064S4	555.00

30"	CBU213064VS4	\$ 395.00
36"	CBU213664VS4	435.00
42"	CBU214264VS4	495.00
48"	CBU214864VS4	515.00
54"	CBU215464VS4	570.00
60"	CBU216064VS4	610.00

28¼"	CBA213064VS4	\$ 320.00
34¼"	CBA213664VS4	365.00
40¼"	CBA214264VS4	420.00
46¼"	CBA214864VS4	440.00
52¼"	CBA215464VS4	495.00
58¼"	CBA216064VS4	535.00

24"
DEPTH

30"	CBU243064S4	\$ 425.00
36"	CBU243664S4	465.00
42"	CBU244264S4	515.00
48"	CBU244864S4	550.00
54"	CBU245464S4	600.00
60"	CBU246064S4	640.00

28¼"	CBA243064S4	\$ 350.00
34¼"	CBA243664S4	390.00
40¼"	CBA244264S4	440.00
46¼"	CBA244864S4	475.00
52¼"	CBA245464S4	525.00
58¼"	CBA246064S4	565.00

30"	CBU243064VS4	\$ 415.00
36"	CBU243664VS4	450.00
42"	CBU244264VS4	500.00
48"	CBU244864VS4	535.00
54"	CBU245464VS4	580.00
60"	CBU246064VS4	615.00

28¼"	CBA243064VS4	\$ 335.00
34¼"	CBA243664VS4	375.00
40¼"	CBA244264VS4	425.00
46¼"	CBA244864VS4	460.00
52¼"	CBA245464VS4	505.00
58¼"	CBA246064VS4	540.00

Color: Brushed Graphite (580).

V4

4-Shelf Vented Stationary Starter and Add-On Units

V5

5-Shelf Vented Stationary Starter and Add-On Units

Units ship complete in 1 box and include 1 or 2 factory assembled post kits, traverses, dovetails and shelf plates.

72"

HEIGHT

18"

DEPTH

Starter

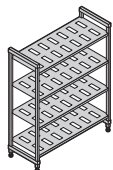

Add-On

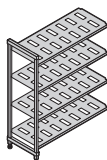

LENGTH	CODE	LIST PRICE EA.
30"	CBU183072V4	\$ 365.00
36"	CBU183672V4	400.00
42"	CBU184272V4	450.00
48"	CBU184872V4	465.00
54"	CBU185472V4	515.00
60"	CBU186072V4	550.00

LENGTH	CODE	LIST PRICE EA.
28¼"	CBA183072V4	\$ 290.00
34¼"	CBA183672V4	325.00
40¼"	CBA184272V4	375.00
46¼"	CBA184872V4	390.00
52¼"	CBA185472V4	440.00
58¼"	CBA186072V4	475.00

Starter

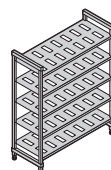

Add-On

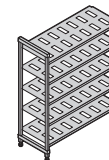

LENGTH	CODE	LIST PRICE EA.
30"	CBU183072V5	\$ 420.00
36"	CBU183672V5	465.00
42"	CBU184272V5	525.00
48"	CBU184872V5	545.00
54"	CBU185472V5	605.00
60"	CBU186072V5	650.00

LENGTH	CODE	LIST PRICE EA.
28¼"	CBA183072V5	\$ 345.00
34¼"	CBA183672V5	390.00
40¼"	CBA184272V5	450.00
46¼"	CBA184872V5	470.00
52¼"	CBA185472V5	530.00
58¼"	CBA186072V5	575.00

21"

DEPTH

30"	CBU213072V4	\$ 395.00
36"	CBU213672V4	435.00
42"	CBU214272V4	490.00
48"	CBU214872V4	515.00
54"	CBU215472V4	570.00
60"	CBU216072V4	605.00

28¼"	CBA213072V4	\$ 320.00
34¼"	CBA213672V4	360.00
40¼"	CBA214272V4	415.00
46¼"	CBA214872V4	435.00
52¼"	CBA215472V4	490.00
58¼"	CBA216072V4	530.00

30"	CBU213072V5	\$ 455.00
36"	CBU213672V5	510.00
42"	CBU214272V5	575.00
48"	CBU214872V5	605.00
54"	CBU215472V5	670.00
60"	CBU216072V5	720.00

28¼"	CBA213072V5	\$ 380.00
34¼"	CBA213672V5	430.00
40¼"	CBA214272V5	500.00
46¼"	CBA214872V5	525.00
52¼"	CBA215472V5	595.00
58¼"	CBA216072V5	645.00

24"

DEPTH

30"	CBU243072V4	\$ 410.00
36"	CBU243672V4	450.00
42"	CBU244272V4	500.00
48"	CBU244872V4	530.00
54"	CBU245472V4	575.00
60"	CBU246072V4	610.00

28¼"	CBA243072V4	\$ 335.00
34¼"	CBA243672V4	370.00
40¼"	CBA244272V4	420.00
46¼"	CBA244872V4	455.00
52¼"	CBA245472V4	500.00
58¼"	CBA246072V4	535.00

30"	CBU243072V5	\$ 475.00
36"	CBU243672V5	520.00
42"	CBU244272V5	585.00
48"	CBU244872V5	625.00
54"	CBU245472V5	680.00
60"	CBU246072V5	725.00

28¼"	CBA243072V5	\$ 400.00
34¼"	CBA243672V5	445.00
40¼"	CBA244272V5	505.00
46¼"	CBA244872V5	545.00
52¼"	CBA245472V5	605.00
58¼"	CBA246072V5	650.00

S4

4-Shelf Solid Stationary Starter and Add-On Units

VS4

4-Shelf Vented and Solid Stationary Starter and Add-On Units

(3 Vented + 1 Solid)

Units ship complete in 1 box and include 1 or 2 factory assembled post kits, traverses, dovetails and shelf plates.

72"
HEIGHT

Starter

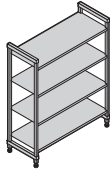

Add-On

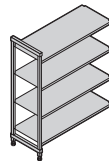

18"
DEPTH

LENGTH	CODE	LIST PRICE EA.
30"	CBU183072S4	\$ 375.00
36"	CBU183672S4	410.00
42"	CBU184272S4	465.00
48"	CBU184872S4	480.00
54"	CBU185472S4	535.00
60"	CBU186072S4	570.00

LENGTH	CODE	LIST PRICE EA.
28¼"	CBA183072S4	\$ 300.00
34¼"	CBA183672S4	340.00
40¼"	CBA184272S4	390.00
46¼"	CBA184872S4	405.00
52¼"	CBA185472S4	460.00
58¼"	CBA186072S4	495.00

Starter

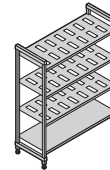

Add-On

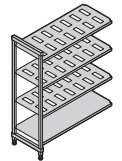

LENGTH	CODE	LIST PRICE EA.
30"	CBU183072VS4	\$ 365.00
36"	CBU183672VS4	405.00
42"	CBU184272VS4	455.00
48"	CBU184872VS4	470.00
54"	CBU185472VS4	520.00
60"	CBU186072VS4	555.00

LENGTH	CODE	LIST PRICE EA.
28¼"	CBA183072VS4	\$ 293.00
34¼"	CBA183672VS4	330.00
40¼"	CBA184272VS4	380.00
46¼"	CBA184872VS4	395.00
52¼"	CBA185472VS4	445.00
58¼"	CBA186072VS4	480.00

21"
DEPTH

30"	CBU213072S4	\$ 410.00
36"	CBU213672S4	450.00
42"	CBU214272S4	510.00
48"	CBU214872S4	535.00
54"	CBU215472S4	590.00
60"	CBU216072S4	630.00

28¼"	CBA213072S4	\$ 330.00
34¼"	CBA213672S4	375.00
40¼"	CBA214272S4	430.00
46¼"	CBA214872S4	460.00
52¼"	CBA215472S4	515.00
58¼"	CBA216072S4	555.00

30"	CBU213072VS4	\$ 400.00
36"	CBU213672VS4	440.00
42"	CBU214272VS4	495.00
48"	CBU214872VS4	520.00
54"	CBU215472VS4	575.00
60"	CBU216072VS4	610.00

28¼"	CBA213072VS4	\$ 320.00
34¼"	CBA213672VS4	365.00
40¼"	CBA214272VS4	420.00
46¼"	CBA214872VS4	440.00
52¼"	CBA215472VS4	500.00
58¼"	CBA216072VS4	535.00

24"
DEPTH

30"	CBU243072S4	\$ 425.00
36"	CBU243672S4	470.00
42"	CBU244272S4	520.00
48"	CBU244872S4	555.00
54"	CBU245472S4	605.00
60"	CBU246072S4	645.00

28¼"	CBA243072S4	\$ 350.00
34¼"	CBA243672S4	395.00
40¼"	CBA244272S4	445.00
46¼"	CBA244872S4	480.00
52¼"	CBA245472S4	530.00
58¼"	CBA246072S4	565.00

30"	CBU243072VS4	\$ 415.00
36"	CBU243672VS4	455.00
42"	CBU244272VS4	505.00
48"	CBU244872VS4	535.00
54"	CBU245472VS4	585.00
60"	CBU246072VS4	620.00

28¼"	CBA243072VS4	\$ 340.00
34¼"	CBA243672VS4	375.00
40¼"	CBA244272VS4	425.00
46¼"	CBA244872VS4	460.00
52¼"	CBA245472VS4	505.00
58¼"	CBA246072VS4	540.00

Color: Brushed Graphite (580).

V4

4-Shelf Vented Stationary Starter and Add-On Units

V5

5-Shelf Vented Stationary Starter and Add-On Units

Units ship complete in 1 box and include 1 or 2 factory assembled post kits, traverses, dovetails and shelf plates.

84"
HEIGHT

18"
DEPTH

Starter

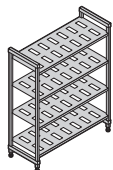

Add-On

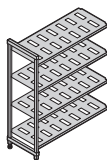

LENGTH	CODE	LIST PRICE EA.
30"	CBU183084V4	\$ 390.00
36"	CBU183684V4	425.00
42"	CBU184284V4	475.00
48"	CBU184884V4	490.00
54"	CBU185484V4	540.00
60"	CBU186084V4	570.00

LENGTH	CODE	LIST PRICE EA.
28¼"	CBA183084V4	\$ 300.00
34¼"	CBA183684V4	335.00
40¼"	CBA184284V4	385.00
46¼"	CBA184884V4	405.00
52¼"	CBA185484V4	450.00
58¼"	CBA186084V4	485.00

21"
DEPTH

30"	CBU213084V4	\$ 420.00
36"	CBU213684V4	460.00
42"	CBU214284V4	515.00
48"	CBU214884V4	535.00
54"	CBU215484V4	590.00
60"	CBU216084V4	630.00

28¼"	CBA213084V4	\$ 330.00
34¼"	CBA213684V4	370.00
40¼"	CBA214284V4	425.00
46¼"	CBA214884V4	450.00
52¼"	CBA215484V4	505.00
58¼"	CBA216084V4	540.00

24"
DEPTH

30"	CBU243084V4	\$ 435.00
36"	CBU243684V4	470.00
42"	CBU244284V4	520.00
48"	CBU244884V4	555.00
54"	CBU245484V4	600.00
60"	CBU246084V4	635.00

28¼"	CBA243084V4	\$ 345.00
34¼"	CBA243684V4	385.00
40¼"	CBA244284V4	430.00
46¼"	CBA244884V4	465.00
52¼"	CBA245484V4	510.00
58¼"	CBA246084V4	545.00

Starter

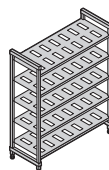

Add-On

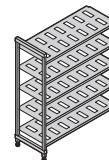

LENGTH	CODE	LIST PRICE EA.
30"	CBU183084V5	\$ 440.00
36"	CBU183684V5	485.00
42"	CBU184284V5	550.00
48"	CBU184884V5	570.00
54"	CBU185484V5	630.00
60"	CBU186084V5	670.00

LENGTH	CODE	LIST PRICE EA.
28¼"	CBA183084V5	\$ 355.00
34¼"	CBA183684V5	400.00
40¼"	CBA184284V5	460.00
46¼"	CBA184884V5	485.00
52¼"	CBA185484V5	545.00
58¼"	CBA186084V5	585.00

30"	CBU213084V5	\$ 480.00
36"	CBU213684V5	530.00
42"	CBU214284V5	600.00
48"	CBU214884V5	625.00
54"	CBU215484V5	695.00
60"	CBU216084V5	740.00

28¼"	CBA213084V5	\$ 390.00
34¼"	CBA213684V5	445.00
40¼"	CBA214284V5	510.00
46¼"	CBA214884V5	540.00
52¼"	CBA215484V5	610.00
58¼"	CBA216084V5	655.00

30"	CBU243084V5	\$ 500.00
36"	CBU243684V5	545.00
42"	CBU244284V5	605.00
48"	CBU244884V5	645.00
54"	CBU245484V5	705.00
60"	CBU246084V5	750.00

28¼"	CBA243084V5	\$ 410.00
34¼"	CBA243684V5	455.00
40¼"	CBA244284V5	520.00
46¼"	CBA244884V5	560.00
52¼"	CBA245484V5	615.00
58¼"	CBA246084V5	660.00

S4

4-Shelf Solid Stationary Starter and Add-On Units

S5

5-Shelf Solid Stationary Starter and Add-On Units

Units ship complete in 1 box and include 1 or 2 factory assembled post kits, traverses, dovetails and shelf plates.

84"
HEIGHT

Starter

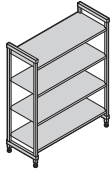

Add-On

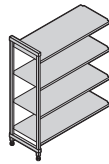

18"
DEPTH

LENGTH	CODE	LIST PRICE EA.
30"	CBU183084S4	\$ 395.00
36"	CBU183684S4	435.00
42"	CBU184284S4	490.00
48"	CBU184884S4	505.00
54"	CBU185484S4	555.00
60"	CBU186084S4	595.00

LENGTH	CODE	LIST PRICE EA.
28¼"	CBA183084S4	\$ 310.00
34¼"	CBA183684S4	350.00
40¼"	CBA184284S4	400.00
46¼"	CBA184884S4	420.00
52¼"	CBA185484S4	470.00
58¼"	CBA186084S4	505.00

Starter

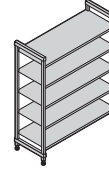

Add-On

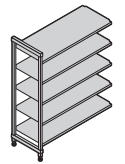

LENGTH	CODE	LIST PRICE EA.
30"	CBU183084S5	\$ 455.00
36"	CBU183684S5	500.00
42"	CBU184284S5	565.00
48"	CBU184884S5	585.00
54"	CBU185484S5	655.00
60"	CBU186084S5	700.00

LENGTH	CODE	LIST PRICE EA.
28¼"	CBA183084S5	\$ 370.00
34¼"	CBA183684S5	415.00
40¼"	CBA184284S5	480.00
46¼"	CBA184884S5	500.00
52¼"	CBA185484S5	565.00
58¼"	CBA186084S5	610.00

21"
DEPTH

30"	CBU213084S4	\$ 430.00
36"	CBU213684S4	475.00
42"	CBU214284S4	530.00
48"	CBU214884S4	560.00
54"	CBU215484S4	615.00
60"	CBU216084S4	655.00

28¼"	CBA213084S4	\$ 345.00
34¼"	CBA213684S4	390.00
40¼"	CBA214284S4	445.00
46¼"	CBA214884S4	470.00
52¼"	CBA215484S4	525.00
58¼"	CBA216084S4	565.00

30"	CBU213084S5	\$ 495.00
36"	CBU213684S5	550.00
42"	CBU214284S5	620.00
48"	CBU214884S5	655.00
54"	CBU215484S5	725.00
60"	CBU216084S5	775.00

28¼"	CBA213084S5	\$ 405.00
34¼"	CBA213684S5	460.00
40¼"	CBA214284S5	535.00
46¼"	CBA214884S5	565.00
52¼"	CBA215484S5	635.00
58¼"	CBA216084S5	685.00

24"
DEPTH

30"	CBU243084S4	\$ 450.00
36"	CBU243684S4	495.00
42"	CBU244284S4	545.00
48"	CBU244884S4	580.00
54"	CBU245484S4	630.00
60"	CBU246084S4	665.00

28¼"	CBA243084S4	\$ 360.00
34¼"	CBA243684S4	405.00
40¼"	CBA244284S4	455.00
46¼"	CBA244884S4	490.00
52¼"	CBA245484S4	540.00
58¼"	CBA246084S4	580.00

30"	CBU243084S5	\$ 520.00
36"	CBU243684S5	570.00
42"	CBU244284S5	635.00
48"	CBU244884S5	680.00
54"	CBU245484S5	740.00
60"	CBU246084S5	790.00

28¼"	CBA243084S5	\$ 430.00
34¼"	CBA243684S5	485.00
40¼"	CBA244284S5	545.00
46¼"	CBA244884S5	590.00
52¼"	CBA245484S5	655.00
58¼"	CBA246084S5	700.00

Color: Brushed Graphite (580).

VS4

4-Shelf Vented and Solid Stationary Starter and Add-On Units

(3 vented + 1 solid)

VS5

5-Shelf Vented and Solid Stationary Starter and Add-On Units

(4 vented + 1 solid)

Units ship complete in 1 box and include 1 or 2 factory assembled post kits, traverses, dovetails and shelf plates.

84"
HEIGHT

18"
DEPTH

Starter

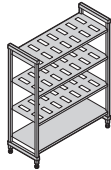

Add-On

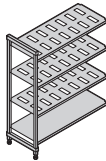

LENGTH	CODE	LIST PRICE EA.
30"	CBU183084VS4	\$ 390.00
36"	CBU183684VS4	425.00
42"	CBU184284VS4	475.00
48"	CBU184884VS4	495.00
54"	CBU185484VS4	545.00
60"	CBU186084VS4	575.00

LENGTH	CODE	LIST PRICE EA.
28¼"	CBA183084VS4	\$ 305.00
34¼"	CBA183684VS4	340.00
40¼"	CBA184284VS4	390.00
46¼"	CBA184884VS4	405.00
52¼"	CBA185484VS4	455.00
58¼"	CBA186084VS4	490.00

Starter

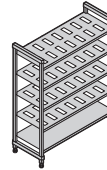

Add-On

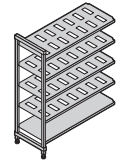

LENGTH	CODE	LIST PRICE EA.
30"	CBU183084VS5	\$ 445.00
36"	CBU183684VS5	490.00
42"	CBU184284VS5	550.00
48"	CBU184884VS5	575.00
54"	CBU185484VS5	635.00
60"	CBU186084VS5	675.00

LENGTH	CODE	LIST PRICE EA.
28¼"	CBA183084VS5	\$ 360.00
34¼"	CBA183684VS5	405.00
40¼"	CBA184284VS5	465.00
46¼"	CBA184884VS5	485.00
52¼"	CBA185484VS5	550.00
58¼"	CBA186084VS5	590.00

21"
DEPTH

30"	CBU213084VS4	\$ 420.00
36"	CBU213684VS4	465.00
42"	CBU214284VS4	520.00
48"	CBU214884VS4	540.00
54"	CBU215484VS4	595.00
60"	CBU216084VS4	635.00

28¼"	CBA213084VS4	\$ 335.00
34¼"	CBA213684VS4	375.00
40¼"	CBA214284VS4	430.00
46¼"	CBA214884VS4	455.00
52¼"	CBA215484VS4	510.00
58¼"	CBA216084VS4	545.00

30"	CBU213084VS5	\$ 480.00
36"	CBU213684VS5	535.00
42"	CBU214284VS5	605.00
48"	CBU214884VS5	630.00
54"	CBU215484VS5	700.00
60"	CBU216084VS5	750.00

28¼"	CBA213084VS5	\$ 395.00
34¼"	CBA213684VS5	445.00
40¼"	CBA214284VS5	515.00
46¼"	CBA214884VS5	545.00
52¼"	CBA215484VS5	615.00
58¼"	CBA216084VS5	660.00

24"
DEPTH

30"	CBU243084VS4	\$ 440.00
36"	CBU243684VS4	475.00
42"	CBU244284VS4	525.00
48"	CBU244884VS4	560.00
54"	CBU245484VS4	605.00
60"	CBU246084VS4	640.00

28¼"	CBA243084VS4	\$ 350.00
34¼"	CBA243684VS4	390.00
40¼"	CBA244284VS4	440.00
46¼"	CBA244884VS4	470.00
52¼"	CBA245484VS4	520.00
58¼"	CBA246084VS4	555.00

30"	CBU243084VS5	\$ 505.00
36"	CBU243684VS5	550.00
42"	CBU244284VS5	610.00
48"	CBU244884VS5	655.00
54"	CBU245484VS5	710.00
60"	CBU246084VS5	755.00

28¼"	CBA243084VS5	\$ 415.00
34¼"	CBA243684VS5	460.00
40¼"	CBA244284VS5	525.00
46¼"	CBA244884VS5	565.00
52¼"	CBA245484VS5	625.00
58¼"	CBA246084VS5	665.00



Stationary Post Kits

Ships **unassembled** in 1 box. Includes 2 stationary posts, post connectors and post connector wedges.



64"
HEIGHT

CODE	DIMENSIONS D x H	LIST PRICE EA.
CBPK1864	18" x 64"	\$ 72.80
CBPK2164	21" x 64"	74.65
CBPK2464	24" x 64"	75.30

72"
HEIGHT

CBPK1872	18" x 72"	\$ 74.45
CBPK2172	21" x 72"	76.25
CBPK2472	24" x 72"	76.90

84"
HEIGHT

CBPK1884	18" x 84"	\$ 86.10
CBPK2184	21" x 84"	87.85
CBPK2484	24" x 84"	88.45

Color: Brushed Graphite (580).

V1

Single Vented Shelf Kits

S1

Single Solid Shelf Kits

Includes 2 shelf traverses, traverse dovetails and vented or solid shelf plates. Ships in 1 box.

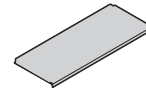
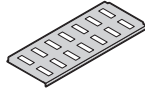

18"
DEPTH

CODE	DIMENSIONS D x L	LIST PRICE EA.
CBSK1830V1	18" x 30"	\$ 53.95
CBSK1836V1	18" x 36"	62.85
CBSK1842V1	18" x 42"	75.10
CBSK1848V1	18" x 48"	79.45
CBSK1854V1	18" x 54"	91.55
CBSK1860V1	18" x 60"	99.80

18"
DEPTH

CODE	DIMENSIONS D x L	LIST PRICE EA.
CBSK1830S1	18" x 30"	\$ 56.30
CBSK1836S1	18" x 36"	65.85
CBSK1842S1	18" x 42"	78.85
CBSK1848S1	18" x 48"	82.95
CBSK1854S1	18" x 54"	96.10
CBSK1860S1	18" x 60"	105.00

21"
DEPTH

CBSK2130V1	21" x 30"	\$ 60.65
CBSK2136V1	21" x 36"	71.05
CBSK2142V1	21" x 42"	84.85
CBSK2148V1	21" x 48"	90.05
CBSK2154V1	21" x 54"	104.00
CBSK2160V1	21" x 60"	113.00

21"
DEPTH

CBSK2130S1	21" x 30"	\$ 63.90
CBSK2136S1	21" x 36"	74.90
CBSK2142S1	21" x 42"	88.95
CBSK2148S1	21" x 48"	95.70
CBSK2154S1	21" x 54"	110.00
CBSK2160S1	21" x 60"	119.00

24"
DEPTH

CBSK2430V1	24" x 30"	\$ 64.65
CBSK2436V1	24" x 36"	73.70
CBSK2442V1	24" x 42"	86.00
CBSK2448V1	24" x 48"	94.10
CBSK2454V1	24" x 54"	106.00
CBSK2460V1	24" x 60"	114.00

24"
DEPTH

CBSK2430S1	24" x 30"	\$ 68.25
CBSK2436S1	24" x 36"	79.00
CBSK2442S1	24" x 42"	91.50
CBSK2448S1	24" x 48"	100.20
CBSK2454S1	24" x 54"	113.00
CBSK2460S1	24" x 60"	122.00

V4 4-Shelf Vented Kits

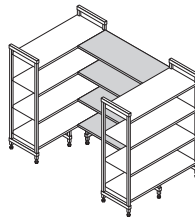

S4 4-Shelf Solid Kits

Includes 8 shelf traverses, traverse dovetails and vented or solid shelf plates.
Ships in 1 box. Install with 8 sets of corner connectors (CBCC8) to create a U-shape unit.

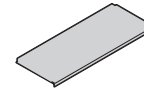
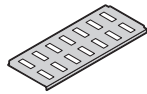

18"
DEPTH

CODE	DIMENSIONS D x L	LIST PRICE EA.
CBSK1836V4	18" x 36"	\$ 251.00
CBSK1842V4	18" x 42"	300.00
CBSK1848V4	18" x 48"	320.00

18"
DEPTH

CODE	DIMENSIONS D x L	LIST PRICE EA.
CBSK1836S4	18" x 36"	\$ 263.00
CBSK1842S4	18" x 42"	315.00
CBSK1848S4	18" x 48"	330.00

21"
DEPTH

CBSK2136V4	21" x 36"	\$ 284.00
CBSK2142V4	21" x 42"	340.00
CBSK2148V4	21" x 48"	360.00

21"
DEPTH

CBSK2136S4	21" x 36"	\$ 300.00
CBSK2142S4	21" x 42"	355.00
CBSK2148S4	21" x 48"	385.00

24"
DEPTH

CBSK2436V4	24" x 36"	\$ 295.00
CBSK2442V4	24" x 42"	345.00
CBSK2448V4	24" x 48"	375.00

24"
DEPTH

CBSK2436S4	24" x 36"	\$ 315.00
CBSK2442S4	24" x 42"	365.00
CBSK2448S4	24" x 48"	400.00

V5 5-Shelf Vented Kits

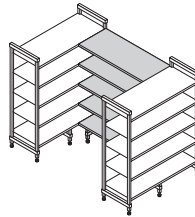

S5 5-Shelf Solid Kits

Includes 10 shelf traverses, traverse dovetails and vented or solid shelf plates.
Ships in 1 box. Install with 10 sets of corner connectors (CBCC10) to create a U-shape unit.

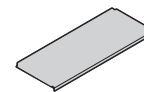
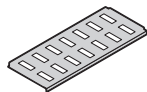

18"
DEPTH

CODE	DIMENSIONS D x L	LIST PRICE EA.
CBSK1836V5	18" x 36"	\$ 315.00
CBSK1842V5	18" x 42"	375.00
CBSK1848V5	18" x 48"	395.00

18"
DEPTH

CODE	DIMENSIONS D x L	LIST PRICE EA.
CBSK1836S5	18" x 36"	\$ 330.00
CBSK1842S5	18" x 42"	395.00
CBSK1848S5	18" x 48"	415.00

21"
DEPTH

CBSK2136V5	21" x 36"	\$ 355.00
CBSK2142V5	21" x 42"	425.00
CBSK2148V5	21" x 48"	450.00

21"
DEPTH

CBSK2136S5	21" x 36"	\$ 375.00
CBSK2142S5	21" x 42"	445.00
CBSK2148S5	21" x 48"	480.00

24"
DEPTH

CBSK2436V5	24" x 36"	\$ 370.00
CBSK2442V5	24" x 42"	430.00
CBSK2448V5	24" x 48"	470.00

24"
DEPTH

CBSK2436S5	24" x 36"	\$ 395.00
CBSK2442S5	24" x 42"	460.00
CBSK2448S5	24" x 48"	500.00

VS4 4-Shelf Kits

(3 Vented + 1 Solid)

Includes 8 shelf traverses, traverse dovetails and vented and solid shelf plates. Ships in 1 box. Install with 8 sets of corner connectors (CBCC8) to create a U-shape unit.

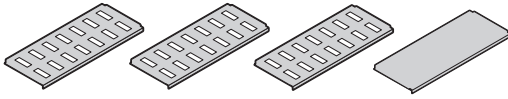

18"
DEPTH

CODE	DIMENSIONS D x L	LIST PRICE EA.
CBSK1836VS4	18" x 36"	\$ 254.00
CBSK1842VS4	18" x 42"	305.00
CBSK1848VS4	18" x 48"	320.00

21"
DEPTH

CBSK2136VS4	21" x 36"	\$ 288.00
CBSK2142VS4	21" x 42"	345.00
CBSK2148VS4	21" x 48"	365.00

24"
DEPTH

CBSK2436VS4	24" x 36"	\$ 300.00
CBSK2442VS4	24" x 42"	350.00
CBSK2448VS4	24" x 48"	380.00

VS5 5-Shelf Kits

(4 Vented + 1 Solid)

Includes 10 shelf traverses, traverse dovetails and vented and solid shelf plates. Ships in 1 box. Install with 10 sets of corner connectors (CBCC10) to create a U-shape unit.

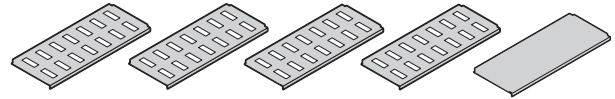

18"
DEPTH

CODE	DIMENSIONS D x L	LIST PRICE EA.
CBSK1836VS5	18" x 36"	\$ 315.00
CBSK1842VS5	18" x 42"	380.00
CBSK1848VS5	18" x 48"	400.00

21"
DEPTH

CBSK2136VS5	21" x 36"	\$ 360.00
CBSK2142VS5	21" x 42"	430.00
CBSK2148VS5	21" x 48"	455.00

24"
DEPTH

CBSK2436VS5	24" x 36"	\$ 375.00
CBSK2442VS5	24" x 42"	435.00
CBSK2448VS5	24" x 48"	475.00

Color: Brushed Graphite (580).



Corner Connectors

For use only with shelves 30" - 48" long. Unique patented design ensures maximum shelf space utilization. Use 1 set per shelf to connect starter and add-on units in corners. Connect 4 or 5 intermediate shelves between 2 starter units (2 sets required per shelf). Available as a single set or 8 or 10 set packs.

CODE	DESCRIPTION	LIST PRICE EA.
CBCC1	1 Set for 1 Shelf	\$ 5.95
CBCC8	8 Sets for 4 Shelves	47.45
CBCC10	10 Sets for 5 Shelves	59.35

Color: Brushed Graphite (580).

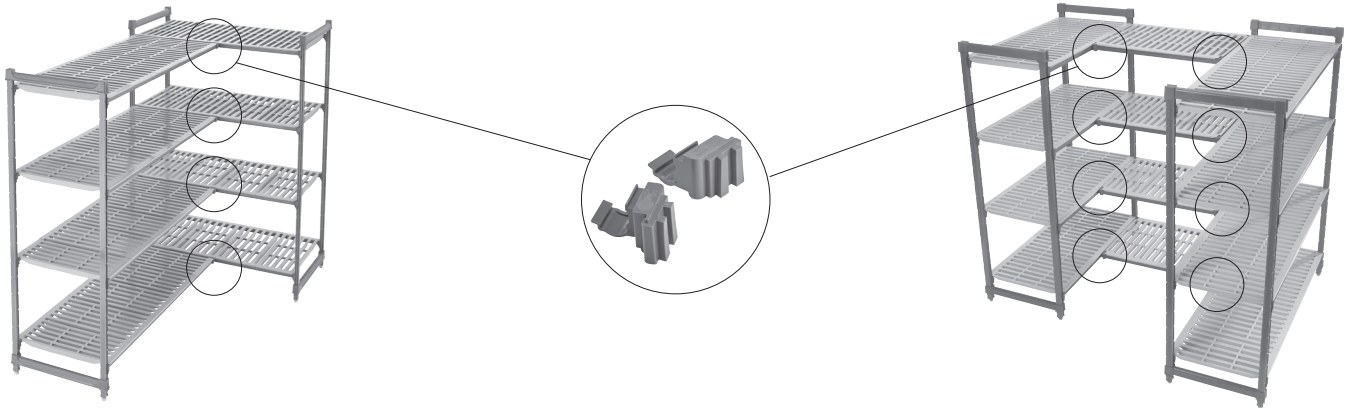

Bottom Shelf Dunnage Stands

Increase weight bearing capacity on bottom shelf only. Add to any shelf length. Highly recommended for starter units 54" and longer and all corner units, intermediate units and units specified for heavier load volume on and off bottom shelves.

CODE	DIMENSIONS D x H	LIST PRICE EA.
Dunnage Stand – Low (bottom shelf installed on lowest set of open post locations for dovetails)		
CBDS18H6	18" x 6¾"	\$ 54.35
CBDS21H6	21" x 6¾"	55.80
CBDS24H6	24" x 6¾"	57.10
Dunnage Stand – Tall (bottom shelf installed up on 2nd set of open post locations for dovetails)		
CBDS18H10	18" x 10¾"	54.55
CBDS21H10	21" x 10¾"	56.00
CBDS24H10	24" x 10¾"	57.35

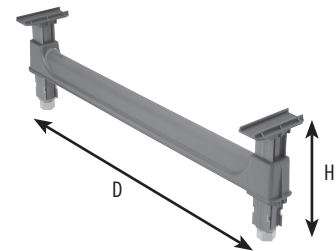
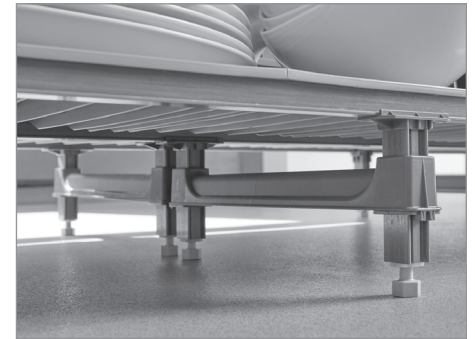

Bottom Shelf with Dunnage Stand

UNIT LENGTH	WEIGHT BEARING
Standard Unit	
30" - 48"	1,000 lbs.
54" - 60"	800
Corner Unit with 2 Dunnage Stands	
30" - 48"	450

Case Pack: 1 **Color:** Brushed Graphite (580).

Shelf Traverses

Add single stationary traverse on the back of a stationary unit for extra support when significant space is required between the bottom and second shelf shelf or when placing rolling equipment under the first shelf. Traverse dovetails included.

LENGTH	SINGLE PACK CODE*	LIST PRICE EA.	DOUBLE PACK CODE**	LIST PRICE EA.
30"	CBTR30	\$ 29.20	CBTR302PK	\$ 53.05
36"	CBTR36	29.40	CBTR362PK	53.45
42"	CBTR42	32.65	CBTR422PK	59.20
48"	CBTR48	35.70	CBTR482PK	64.90
54"	CBTR54	38.95	CBTR542PK	70.65
60"	CBTR60	41.90	CBTR602PK	76.15



*Case Pack: 1 **Case Pack: 2 **Color:** Brushed Graphite (580).

CAMSHELVING® ACCESSORIES

Shelf Rail Kits

Use to prevent contents from falling off shelves. Protect individual sides or ends or wrap a full shelf. Rods are made from a strong composite material that is highly durable and will never rust or corrode. Fits shelving units 24" to 72" long and 14" to 24" deep. Full or three-quarter shelf kits help to streamline installations and significantly reduces carton waste.



	SHELF LENGTH	24"*	30"	36"	42"	48"	54"	60"	72"*
Full Shelf Rail Kits (Includes 2 sides and 2 ends in 1 box)									
14" DEPTH	PREMIUM	CPR1424	CPR1430	CPR1436	CPR1442	CPR1448	CPR1454	CPR1460	CPR1472
	ELEMENTS	ESR1424	ESR1430	ESR1436	ESR1442	ESR1448	ESR1454	ESR1460	ESR1472
	LIST PRICE EA.	\$ 109.00	\$ 115.00	\$ 122.00	\$ 130.00	\$ 137.00	\$ 145.00	\$ 151.00	\$ 166.00
18" DEPTH	PREMIUM	CPR1824	CPR1830	CPR1836	CPR1842	CPR1848	CPR1854	CPR1860	CPR1872
	ELEMENTS	ESR1824	ESR1830	ESR1836	ESR1842	ESR1848	ESR1854	ESR1860	ESR1872
	BASICS PLUS	—	CBR1830	CBR1836	CBR1842	CBR1848	CBR1854	CBR1860	—
	LIST PRICE EA.	\$ 113.00	\$ 119.00	\$ 125.00	\$ 134.00	\$ 140.00	\$ 149.00	\$ 155.00	\$ 170.00
21" DEPTH	PREMIUM	CPR2124	CPR2130	CPR2136	CPR2142	CPR2148	CPR2154	CPR2160	CPR2172
	ELEMENTS	ESR2124	ESR2130	ESR2136	ESR2142	ESR2148	ESR2154	ESR2160	ESR2172
	BASICS PLUS	—	CBR2130	CBR2136	CBR2142	CBR2148	CBR2154	CBR2160	—
	LIST PRICE EA.	\$ 116.00	\$ 122.00	\$ 128.00	\$ 137.00	\$ 143.00	\$ 152.00	\$ 158.00	\$ 173.00
24" DEPTH	PREMIUM	CPR2424	CPR2430	CPR2436	CPR2442	CPR2448	CPR2454	CPR2460	CPR2472
	ELEMENTS	ESR2424	ESR2430	ESR2436	ESR2442	ESR2448	ESR2454	ESR2460	ESR2472
	BASICS PLUS	—	CBR2430	CBR2436	CBR2442	CBR2448	CBR2454	CBR2460	—
	LIST PRICE EA.	\$ 119.00	\$ 125.00	\$ 131.00	\$ 140.00	\$ 146.00	\$ 155.00	\$ 161.00	\$ 176.00

Three-Quarter Shelf Rail Kits (Includes 1 side and 2 ends in 1 box)

14" DEPTH	PREMIUM	CPR14243	CPR14303	CPR14363	CPR14423	CPR14483	CPR14543	CPR14603	CPR14723
	ELEMENTS	ESR14243	ESR14303	ESR14363	ESR14423	ESR14483	ESR14543	ESR14603	ESR14723
	LIST PRICE EA.	\$ 78.05	\$ 81.15	\$ 84.35	\$ 88.60	\$ 91.80	\$ 96.00	\$ 99.15	\$ 107.00
18" DEPTH	PREMIUM	CPR18243	CPR18303	CPR18363	CPR18423	CPR18483	CPR18543	CPR18603	CPR18723
	ELEMENTS	ESR18243	ESR18303	ESR18363	ESR18423	ESR18483	ESR18543	ESR18603	ESR18723
	BASICS PLUS	—	CBR18303	CBR18363	CBR18423	CBR18483	CBR18543	CBR18603	—
	LIST PRICE EA.	\$ 81.85	\$ 84.95	\$ 88.15	\$ 92.40	\$ 95.60	\$ 99.80	\$ 103.00	\$ 110.00
21" DEPTH	PREMIUM	CPR21243	CPR21303	CPR21363	CPR21423	CPR21483	CPR21543	CPR21603	CPR21723
	ELEMENTS	ESR21243	ESR21303	ESR21363	ESR21423	ESR21483	ESR21543	ESR21603	ESR21723
	BASICS PLUS	—	CBR21303	CBR21363	CBR21423	CBR21483	CBR21543	CBR21603	—
	LIST PRICE EA.	\$ 84.70	\$ 87.80	90.95	\$ 95.25	\$ 98.45	\$ 103.00	\$ 106.00	\$ 113.00
24" DEPTH	PREMIUM	CPR24243	CPR24303	CPR24363	CPR24423	CPR24483	CPR24543	CPR24603	CPR24723
	ELEMENTS	ESR24243	ESR24303	ESR24363	ESR24423	ESR24483	ESR24543	ESR24603	ESR24723
	BASICS PLUS	—	CBR24303	CBR24363	CBR24423	CBR24483	CBR24543	CBR24603	—
	LIST PRICE EA.	\$ 87.75	\$ 90.75	\$ 94.00	\$ 98.30	\$ 101.45	\$ 106.00	\$ 109.00	\$ 116.00

Case Pack: 1 kit Color: Soft Gray (151). *Basics Plus Series not available in 14" depth or 24" or 72" length.

Single Side Rail Kits

PREMIUM	ELEMENTS	BASICS PLUS	LENGTH	LIST PRICE EA.
CPR24S	ESR24S	—	24"	\$ 31.05
CPR30S	ESR30S	CBR30S	30"	34.15
CPR36S	ESR36S	CBR36S	36"	37.35
CPR42S	ESR42S	CBR42S	42"	41.60
CPR48S	ESR48S	CBR48S	48"	44.80
CPR54S	ESR54S	CBR54S	54"	49.00
CPR60S	ESR60S	CBR60S	60"	52.15
CPR72S	ESR72S	—	72"	59.60

Case Pack: 1 Color: Soft Gray (151).

Single End Rail Kits

PREMIUM	ELEMENTS	BASICS PLUS	DEPTH	LIST PRICE EA.
CPR14E	ESR14E	—	14"	\$ 23.50
CPR18E	ESR18E	CBR18E	18"	25.40
CPR21E	ESR21E	CBR21E	21"	26.85
CPR24E	ESR24E	CBR24E	24"	28.35

Case Pack: 1 Color: Soft Gray (151).

CAMSHELVING® ACCESSORIES

Shelf Divider Bars

Create a custom service or storage station for food pans, boxes or dish racks. Install straight or angled dividers directly onto shelf traverses. Fits 24" deep shelf only.

CODE	DESCRIPTION	LIST PRICE EA.
Premium® Series		
CSDBA	Angled Divider Bar	\$ 6.20
CSDBS	Straight Divider Bar	6.20
Elements® Series		
EDBA	Angled Divider Bar	4.80
EDBS	Straight Divider Bar	4.80
Case Pack: 4 Color: Speckled Gray (480).		

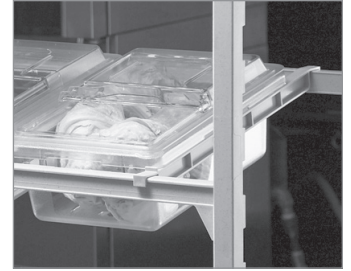
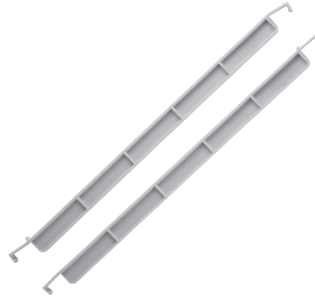

Shelf Divider Panel

Stack and separate items stored on shelves. Made of highly durable plastic. Installs directly onto solid or vented shelves. Easily removable for relocating or washing. Use with Shelf Rails to prevent contents from falling off shelves. Can be installed on shelves inside Full Wrap Security Cage units.

CODE	DIMENSION D x H	LIST PRICE EA.
Premium, Elements & Basics® Plus Series		
CSSD188	18" x 8"	\$ 18.40
CSSD218	21" x 8"	20.00
CSSD248	24" x 8"	21.65
Case Pack: 1 Color: Soft Gray (151).		



Pegboard Storage System

Use to dry, store, and organize light duty products such as lids, drain shelves, tongs, spoons, ladles, mixer paddles, or spatulas. Made of heavy-duty ¼" thick, commercial grade ABS plastic with stainless steel hardware. Includes 12 each double locking 6" straight hooks. Install on the end of 18", 21" or 24" deep Camshelving units or on the wall. Maximum weight bearing per hook is 15 lbs. Per unit is 150 lbs.

CODE	DESCRIPTION	DIMENSION W x D x H	LIST PRICE EA.
CSPEGKIT18	Pegboard Kit, 18" x 48"	16¾" x 48" x ¼"	\$ 320.00
CSPEGKIT21	Pegboard Kit, 21" x 48"	19¾" x 48" x ¼"	365.00
CSPEGKIT24	Pegboard Kit, 24" x 48"	22¾" x 48" x ¼"	410.00
CSPEGKITW	Pegboard Wall Mount Kit	—	40.00
CSPEGH6*	Pegboard 6" Peg Hooks 12 each	—	**50.00

Case Pack: 1 *Case Pack: 12 Pegboard Kit Color: Black (110). Wall Mount Kit and Pegboard Hook Color: Stainless Steel (000). **Sold by the case only. No broken cartons.

Pegboard Kits include 1 Pegboard, 8 Post screws, 1 Drill bit, and 12 Hooks and screws. Wall Mount Kit includes 8 Wall mount screws, 8 Plastic wall anchors, and 8 Wall mount spacers. Peg Hook Kit includes 12 Hooks and screws.

NOTE: Pegboard does NOT fit Camshelving Premium® Series, 32" or 54" high Stationary Units or 35" or 57" high Mobile Units due to the pegboard panel overlapping the available open-end space.



Units ship in



Unique double locking, 6" straight stainless steel pegboard hook features bottom locking tab and top stainless steel screw for extra holding strength and superior stability.

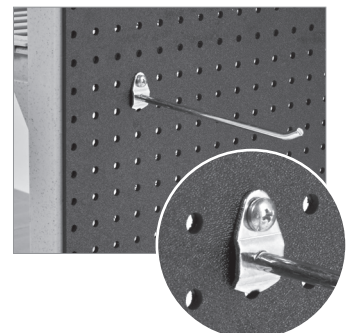

CAMSHELVING® ACCESSORIES

Wall Fastener

Use to secure stationary shelving unit to a wall for added safety and stability where required. Made of 300 series, 11 gauge stainless steel. Screws not included.

CODE	DIMENSION D x L x H	LIST PRICE EA.
Premium®, Elements® & Basics® Plus Series		
CSWF	2 7/8" x 9 3/8" x 1 7/8"	\$ 34.75
Case Pack: 4 Color: Silver (000).		



Hole diameter 7/16".

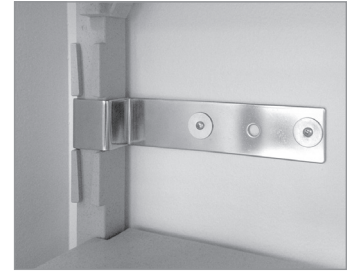

Floor Fasteners

Secure stationary unit posts directly to the floor for added safety and stability where required. Made of 300 series, 11 gauge stainless steel. Bolts not included.

CODE	DIMENSION D x L x H*	LIST PRICE EA.
Premium, Elements & Basics Plus Series		
CSFF	1 1/2" x 6 1/2" x 3 1/2"	\$ 35.70
Premium Series High Density		
CSHDFE	1 3/8" x 4 1/4" x 1/2"	43.40

CSFF Case Pack: 2 CSHDFE Case Pack: 4
Color: Silver (000).

*Height of CSFF includes stainless steel leveling foot.

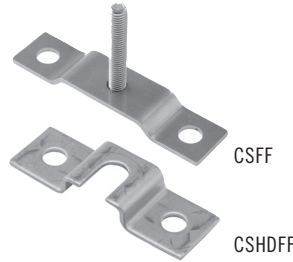

Hole diameter 9/16".

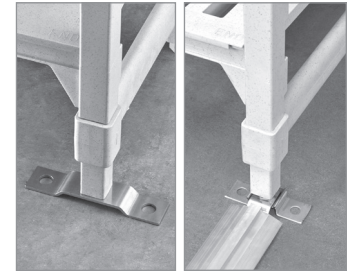

Ultimate Sheet Pan Rack for Single Shelf

Use to free up use of mobile speed racks and maximize storage in walk-in coolers, freezers, and/or work prep stations. Fits 24" or 21" deep vented or solid shelves. Holds up to 6 full size or 12 half size sheet pans. 40 lbs. per rail set, up to 200 lbs. per unit. Heat-tolerant rails accept sheet pans from oven up to 350°F. Secure racks to unit with 2 post clips, front and back for 24" or front only for 21" deep. Installation requires 5 open post dovetails between shelves. Lifetime warranty against rust and corrosion. Ships knockdown.

CODE	DIMENSION D x L x H	LIST PRICE EA.
Premium or Elements Series		
CSUPR1826S6	24 1/2" x 20 1/2" x 20 1/4"	\$ 189.00
Basics Plus Series		
CBUPR1826S6	24 1/2" x 20 1/2" x 20 1/4"	189.00
Case Pack: 1 Color: Brushed Graphite (580). Patent Applied For.		



CAMSHELVING® ACCESSORIES

Identification Tags

Clip onto shelf traverses to clearly identify stored product. Made of highly durable plastic with a clear slide in front panel. 14 labels included: 12 color-coded, pre-printed and 2 blank.

CODE	DESCRIPTION	DIMENSION L x H	LIST PRICE EA.
Premium® and Elements® Series			
CSID6	6" ID Tag	6" x 1"	\$ 2.40
CSID3	3" ID Tag	3" x 1"	2.40
Basics® Plus Series			
CBID6	6" ID Tag	6" x 1"	3.05

Case Pack: 12 **Color:** White / Clear.
Pre-printed, color labels, 2 each: Blue - Cooked Foods, Beige - Fish, Yellow - Poultry, White - Dairy, Green - Fruits and Vegetables, Red - Raw Meat.



Donut Bumpers

Offers added protection during transport and when maneuvering mobile units into place against walls or alongside other units for storage.

CODE	DIAMETER	LIST PRICE EA.
Premium Series		
CPMDB	3½"	\$ 10.10
Premium Series High Density*		
CSMHDDDB	5"	25.00
Elements Series		
CSMHDDDB	5"	25.00

Case Pack: 4 **Color:** Gray (000).

*All High Density Mobile Post Kits and Mobile Units include High Density Casters and Donut Bumpers.

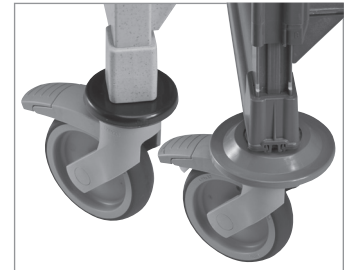
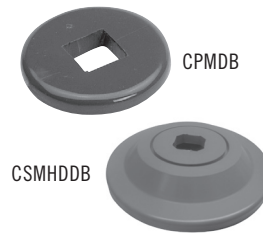

Security Cages

Store valuable products inside locked cage. Choose from single shelf or full wrap. Use in coolers, freezers and/or dry storage. Made of heavy duty, 304 stainless steel. Ships knockdown, lock not included.

Install Full-Wrap Cage on Premium Series 24" x 48" x 64" stationary unit or 24" x 48" x 67" mobile unit. Requires bottom vented shelf for installation. Maximum lock shackle diameter is 5/16".

Install Single Shelf Cage on 24" deep vented shelves only. Requires 18" or 4 open dovetails of space between shelves. Maximum lock shackle diameter is 0.295", between 1/4" and 5/16".

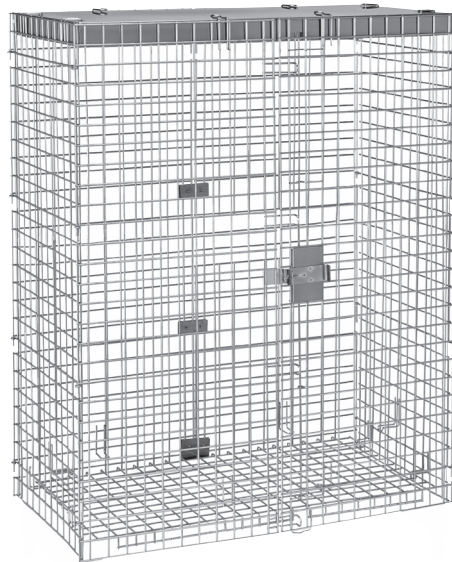

Full-Wrap Security Cage

CODE	DIMENSION D x L x H	LIST PRICE EA.
Premium Series		
CPFWSC244860	26¼" x 50¼" x 61½"	\$ 3,190.00
Case Pack: 1 Color: Silver (000).		



Single Shelf Security Cage

CODE	DIMENSION D x L x H	LIST PRICE EA.
Premium, Elements & Basics Plus Series		
CSSC244818	25¼" x 42½" x 18"	\$ 690.00
Case Pack: 1 Color: Silver (000).		

PREMIUM® SERIES FLEX STATIONS

- Ideal for take-out, delivery, curbside pick-up or classroom feeding.
- Use for bulk food/produce staging, kitchen utensil storage or for paper goods.
- Units ship knockdown complete in 1 box with factory assembled post kits.
- Modular components assemble quickly. Easy to reconfigure as needs change.
- Smooth, plastic surfaces wipe clean. All parts dishwasher safe.
- Anti-microbial shelf plates provide added safety insurance.
- Each unit includes 12 ID tags. Identify contents quickly and minimize handling.
- Premium swivel plastic casters all with total locking brake – locks swivel and wheel.

Flex Stations shown with Optional Merchandiser, Food Storage Pans and/or Boxes, Cam GoBoxes® and Cambro GoBags®. Available for purchase separately.



CPM244867FX1



CPM244867FX2



CPM244867FX3



CPM244875FX4

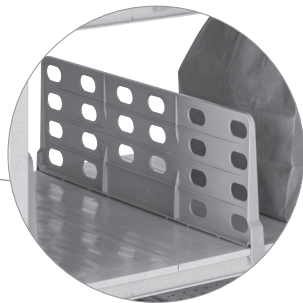

Stack and separate items stored on shelves with 8" high Shelf Divider Panels.



CPM244875FX5

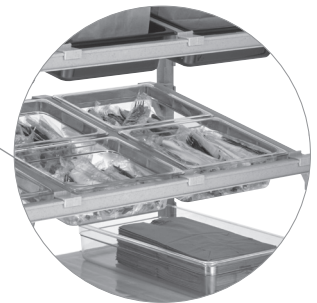

Create a custom station with a variety of food pans or food boxes and Shelf Divider Bars.

CODE	DESCRIPTION	DIMENSION D x L x H*	LIST PRICE EA.
CPM244867FX1	4 Tiers with 36 Angled Divider Bars	24" x 48" x 67"	\$ 1,070.00
CPM244867FX2	1 Solid Shelf, 3 Tiers with 30 Angled Divider Bars	24" x 48" x 67"	1,260.00
CPM244867FX3	4 Solid Shelves with 16 Divider Panels	24" x 48" x 67"	1,510.00
CPM244875FX4	4 Solid Shelves with 16 Divider Panels	24" x 48" x 75"	1,515.00
CPM244875FX5	2 Solid Shelves, 3 Tiers with 30 Angled Divider Bars	24" x 48" x 75"	1,475.00

Color: Speckled Gray (480). *Height includes 5" casters.

Units ship in

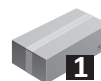

PREMIUM® SERIES FLEX STATIONS

Flex Station Merchandiser Kits

- Made of heavy duty, all weather, durable plastic.
- Contemporary, colorful graphics for enhanced visibility and sales appeal.
- Fresh and Fast Full Kit includes magnetic menu holder on 1 side panel.
- Fits 67" or 75" tall mobile units.

Note: To ensure clearance through doors, please note overall flex station unit height is either 73½" or 81½" with merchandiser header installed on Premium Series Flex Stations.



CSFLEXMERCH
Ideal for promoting educational nutrition programs.

CSFLEXMERCH2
Excellent for customer recognition of pickup & go delivery sites.

CODE	DESCRIPTION	DIMENSION	LIST PRICE EA.
Full Kits (2 Sides/1 Top)			
CSFLEXMERCH	Fast & Fresh	W 23" x H 56" side W 48" x H 6½" header	\$ 1,340.00
CSFLEXMERCH2	Pickup & Go	W 23" x H 56" side W 48" x H 6½" header	1,340.00
Top Panel Kits			
CSFLEXMERCH3	Fast & Fresh	W 48" x H 6½"	675.00
CSFLEXMERCH4	Pickup & Go	W 48" x H 6½"	675.00
Color: Multi (000).			

Units ship in  **1**



MOBILE SHEET PAN/FOOD PAN RACKS

- Made from highly durable, composite plastic materials.
- Virtually unbreakable. 100% warranty against rust and corrosion.
- Low maintenance – no broken welds, dents or sharp edges.
- Easy to clean smooth, wipe down surfaces. Can also be pressure washed.
- Solid top and bottom connectors create a stable, solid frame for smooth handling.
- Sustainable for a lifetime of service with every part replaceable if needed.
- Unique top frame holds sheet pan or food pan(s) to protect contents below.
- Premium swivel plastic casters, all with total locking brake that locks swivel and wheel.
- Units ship knockdown, partially factory assembled, from box to service in minutes.

GN Food Pan Trolleys

- Can be used in coolers and freezers.
- Heat tolerant composite rails accepts hot pans from oven up to 392°F.
- Unique top frame holds GN 1/1 food pan(s) to protect contents below.
- Superior weight bearing per rail set and per unit.
- Place a GN 1/1 cutting board on half size 1/1 trolley for light duty food prep.
- Trolleys ship knockdown with caster and wedges factory assembled onto posts.



COMPONENT Patent Applied For.

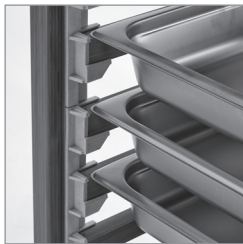

MOLDED IN PAN STOPS
0.12" pan stops at each rail end provide stability during transport.

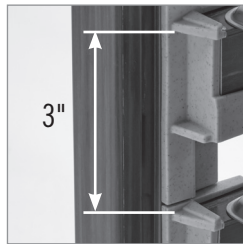

RAIL SPACING
Wide 3" rail spacing offers greatest versatility and ease of use.

GN 1/1 Food Pan Trolley Holding Capacity*

1 Full Size Pan per Rail Set, End Load

	2½"	4"	6"	8"
Full Size Trolley				
1/1 Pans	18	9	9	6
1/2 Pans	36	18	18	12
1/3 Pans	54	27	27	18
Half Size Trolley				
1/1 Pans	9	4	4	3
1/2 Pans	18	8	8	6
1/3 Pans	27	12	12	9

GN 2/1 Food Pan Trolley Holding Capacity*

2 Full Size Pans per Rail Set, Side Load

	2½"	4"	6"	8"
Full Size Trolley				
1/1 Pans	36	18	18	12
Half Size Trolley				
1/1 Pans	18	8	8	6

*Not including top frame position. Top frame holds 1 or 2 GN 1/1 full size food pans. Bottom rail set holds 2 1/2" deep pan(s) only.

MOBILE SHEET PAN/FOOD PAN RACKS

1/1 Food Pan Trolleys



CODE	UGNPR11H9	UGNPR11F18	GBCTUGNPR11
DESCRIPTION	Half Size Trolley	Full Size Trolley	Cover for Full Size Trolley
DIMENSION D x L x H*	28 $\frac{3}{4}$ " x 17 $\frac{1}{4}$ " x 40"	28 $\frac{3}{4}$ " x 17 $\frac{1}{4}$ " x 67 $\frac{1}{2}$ "	26" x 18 $\frac{3}{8}$ " x 60 $\frac{1}{2}$ "
UNIT WEIGHT	32.68 lbs.	53.15 lbs.	—
LIST PRICE EACH	\$ 660.00	\$ 880.00	\$ 150.00

Food Pan Trolley Color: Speckled Gray (480). **Cover Color:** Opaque (CLR). *Includes 5" casters.
Weight capacity: 750 lbs. per full size unit, 375 lbs. per half size unit, 100 lbs. per rail set.

Units ship in  1

2/1 Food Pan Trolleys Coming Soon!



CODE	UGNPR21H18	UGNPR21F36	GBCTUGNPR21
DESCRIPTION	Half Size Trolley	Full Size Trolley	Cover for Full Size Trolley
DIMENSION D x L x H*	32 $\frac{7}{8}$ " x 25 $\frac{3}{8}$ " x 40"	32 $\frac{7}{8}$ " x 25 $\frac{3}{8}$ " x 67 $\frac{1}{8}$ "	31" x 26 $\frac{3}{4}$ " x 60 $\frac{7}{8}$ "
UNIT WEIGHT	37.7 lbs.	60.9 lbs.	—
LIST PRICE EACH	\$ 680.00	\$ 935.00	\$ 168.00

Food Pan Trolley Color: Speckled Gray (480). **Cover Color:** Opaque (000). *Includes 5" casters.
Weight capacity: 750 lbs. per full size unit, 375 lbs. per half size unit, 100 lbs. per rail set.

Units ship in  1

MOBILE SHEET PAN/FOOD PAN RACKS

Ultimate Sheet Pan Racks

- Holds full and half size sheet pans, 14 x 18 and 13 x 18 trays.
- Choose from 3" or 1 1/2" standard rail spacing.
- Use in coolers, freezers, blast chillers or proofing/retarding cabinets.
- Unique top frame holds full size sheet pan to protect contents below.
- Heat tolerant rails accept hot sheet pans from oven up to 350°F.
- Molded in rail ribs promote airflow for cooling and thawing.
- Positioning end ribs center sheet pans during light transport.

Ultimate Sheet Pan Rack is covered by U.S. Patent D853,0780 S and D841,273 S.



Full Size

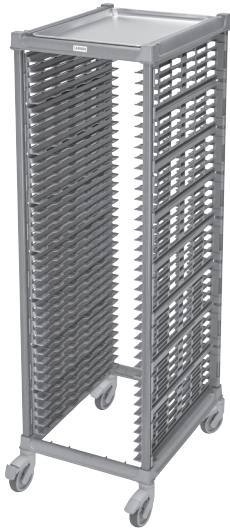

CODE	DIMENSIONS L x W x H*	RAIL SPACING	HOLDING CAPACITY	CASTER TYPE**	LIST PRICE EA.
Knockdown (KD) Units					
UPR1826FP20	33 ³ / ₈ " x 25 ¹ / ₁₆ " x 72 ³ / ₈ "	3"	20 Sheet pans/trays	Plastic	\$ 805.00
UPR1826FP40	33 ³ / ₈ " x 25 ¹ / ₁₆ " x 72 ³ / ₈ "	1 ¹ / ₂ "	40 Sheet pans/trays	Plastic	815.00
Factory Assembled (FA) Units					
UPR1826FPA20	33 ³ / ₈ " x 25 ¹ / ₁₆ " x 72 ³ / ₈ "	3"	20 Sheet pans/trays	Plastic	1,045.00
UPR1826FPA40	33 ³ / ₈ " x 25 ¹ / ₁₆ " x 72 ³ / ₈ "	1 ¹ / ₂ "	40 Sheet pans/trays	Plastic	1,110.00

Color: Brushed Graphite (580). *Dimensions include 5" plastic casters.
Weight capacity: 350 lbs. per rack, 55 lbs. per rail set.

Half Size



CODE	DIMENSIONS L x W x H*	RAIL SPACING	HOLDING CAPACITY	CASTER TYPE**	LIST PRICE EA.
UPR1826HP12	33 ³ / ₈ " x 25 ¹ / ₁₆ " x 48"	3"	12 Sheet pans/trays	Plastic	\$ 590.00
UPR1826HP20	33 ³ / ₈ " x 25 ¹ / ₁₆ " x 41 ¹ / ₈ "	1 ¹ / ₂ "	20 Sheet pans/trays	Plastic	645.00

Color: Brushed Graphite (580). *Dimensions include 5" plastic casters.
Weight capacity: 175 lbs. per rack, 55 lbs. per rail set.

**Full and Half Size Units also available with zinc plated metal casters. For more information about units with metal casters contact your Distributor, Cambro Sales Representative or the Cambro Customer Service Department.

Undercounter



CODE	DIMENSIONS L x W x H*	RAIL SPACING	HOLDING CAPACITY	LIST PRICE EA.
UPR1826U8	30 ⁷ / ₈ " x 23 ¹ / ₄ " x 33 ³ / ₈ "	3"	8 Sheet pans/trays	\$ 520.00
UPR1826U15	30 ⁷ / ₈ " x 23 ¹ / ₄ " x 31 ¹ / ₂ "	1 ¹ / ₂ "	15 Sheet pans/trays	565.00

Color: Brushed Graphite (580). *Dimensions include 3" metal casters.
Weight capacity: 90 lbs. per rack, 55 lbs. per rail set.

All units ship in



MOBILE SHEET PAN/FOOD PAN RACKS

Vinyl Cover

- Opaque, heavy duty vinyl with 2 front zippers.
- Use to protect contents in kitchens, coolers or freezers. Ideal for use when transporting.
- Clear 6" x 9" front window panel.

Insulated Cover

- Durable, insulated nylon with 2 front zippers.
- Helps keep food hot or cold for up to 1 hour.
- Clear front ID pocket.



CODE	GBCTUPR	GBIRC272162
DESCRIPTION	Vinyl Cover	Insulated Cover
DIMENSIONS L x W x H	32" x 24" x 66"	27½" x 21½" x 62"
COLOR	Opaque (CLR)	Black (110)
LIST PRICE EA.	\$ 170.00	\$ 585.00

Case Pack: 1



ULTIMATE #10 CAN RACK SYSTEM

- Front loading, gravity fed storage system.
- Optimizes safe handling and FIFO food rotation.
- Made from 100% highly durable, plastic.
- Lifetime warranty against rust and corrosion.
- Modular pieces snap together easily and quickly without tools.
- Low maintenance versus metal – no dents, bent or sharp edges.
- Ships knockdown. Units include 1 or 2 factory assembled post kits.
- Easy to clean. Dishwasher safe.

#10 Single and Add-on Can Racks are covered by U.S. Patent D828,145 S and D827,421 S.



Storage Capacity

	Per Row	Per Full Unit
#10 can	8 each	96 each
#5 can	12 each	144 each

Full Size Can Rack Unit

- High volume can storage in a compact footprint.
- Install on end(s) of High-Density Floor Track System.



Full Size Starter Unit

Full Size Add-on Can Rack Unit

- Maximize every inch of linear space in your kitchen or dry storage area with an in-line can rack.
- Connect Add-on Units to other units with shared posts.



Starter and Add-On Unit

PREMIUM® SERIES

CODE	CPU243672C96	CPA243672C96*
DESCRIPTION	Full Size Starter Unit	Full Size Add-on Unit (shared posts)
DIMENSION D x L x H	26" x 36" x 72"	26" x 34 1/4" x 72"
LIST PRICE EACH	\$ 1,030.00	\$ 870.00

ELEMENTS® SERIES

ESU243672C96	EA243672C96*
Full Size Starter Unit	Full Size Add-on Unit (shared posts)
26" x 36" x 72"	26" x 34" x 72"
\$ 910.00	\$ 795.00

Premium Series Color: Speckled Gray (480). Elements Series Color: Brushed Graphite (580). *Cannot be installed as corner units.

Units ship in

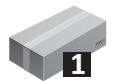

ULTIMATE #10 CAN RACK SYSTEM

Single and Add-on Can Racks

- Create single shelves of can storage on existing or new shelving units.
- Requires additional traverse per shelf length to complete installation.

NOTE: Cannot install on shelves on corner units or on intermediate shelves (shelves installed between 2 units using corner connectors).

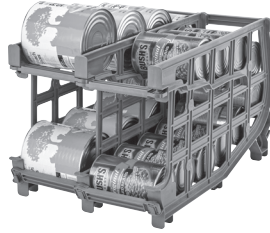

Partial Can Rack Storage

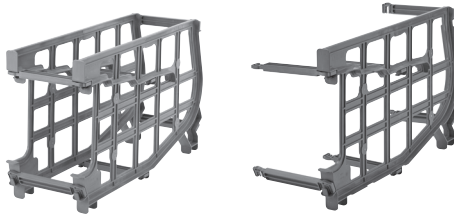

CODE	UCR10R8	UCR10AR8
DESCRIPTION	Single Can Rack, 2 panels and 6 brackets	Add-on Can Rack, 1 panel and 6 brackets
DIMENSION D x L x H	26" x 9¼" x 15½"	26" x 7¼" x 15½"
LIST PRICE EACH	\$ 116.00	\$ 68.25

Case Pack: 1 Color: Brushed Graphite (580).

Can Racks Per Shelf Length

SHELF LENGTH	NUMBER OF CAN RACKS PER TIER**	LEFTOVER SHELF SPACE	#10 CAN HOLDING CAPACITY
24"	2	3.5"	16
30"	3	2"	24
36"	4	0"	32
42"	4	6.5"	32
48"	5	5"	40
54"	6	3.5"	48
60"	7	2"	56

**1 Single Rack plus Add-on Racks.

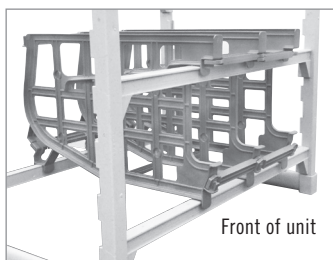

Front of unit

NOTE: Each tier of can racks requires 3 traverses, 2 front and 1 rear. Leave two open dovetails above top traverse before installing the next traverse/tier. This allows space to load cans. Can rack units cannot be specified to create corner units and individual racks cannot be installed on corner units.



PREMIUM® SERIES DRYING AND STORAGE RACKS

- Promotes sanitary air drying and minimizes handling.
- Efficient, high capacity storage in a compact footprint.
- Lifetime warranty against rust and corrosion.
- Cradles are made of highly durable ABS plastic.
- Will never bend or dent. Easy to clean and maintain.
- Racks ship knockdown with factory assembled post kits.
- Premium swivel plastic casters with total locking brake – locks both swivel and wheel.



Premium® Series Vertical Drying and Storage Racks

- For trays, sheet pans, lids and small cutting boards.
- Cradle slot is 1 5/16" wide. Dividers are 2 1/2" high.

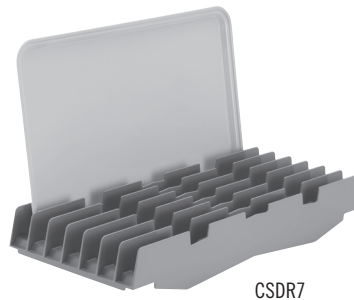

CSDR7



CODE	DIMENSIONS D x L x H*	HOLDING CAPACITY	CASE PACK	LIST PRICE EA.
Premium Series Vertical Drying and Storage Rack				
CPMU244875DRPKG	24" x 48" x 75"	84 Trays	1	\$ 1,525.00
CPMU246075DRPKG	24" x 60" x 75"	105 Trays	1	1,710.00
Vertical Drying and Storage Cradle for 24" deep shelf only (Fits all Camshelving® lines)				
CSDR7	23½" x 10¼" x 3¾"	—	1	60.60
CSDR73	23½" x 10¼" x 3¾"	—	3	182.00

Drying Rack Color: Speckled Gray (480). **Drying Cradle Color:** Soft Gray (151).

*Rack height includes 5" casters.

48" long unit ships in



60" long unit ships in



For building custom racks, use the Custom Drying Rack/Cradle Reference Guide on page 87.

PREMIUM® SERIES DRYING AND STORAGE RACKS

Premium Series Angled Drying and Storage Rack

- For meal delivery pellets, storage containers, food pans, pots and pans.
- Cradle slot is 2 3/8" wide.

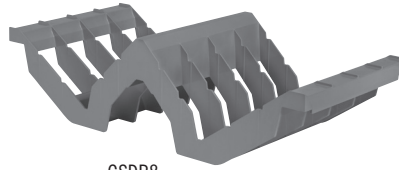

CSDR8



For building custom racks, use the Custom Drying Rack/Cradle Reference Guide on page 87.

CODE	DIMENSIONS D x L x H*	HOLDING CAPACITY	CASE PACK	LIST PRICE EA.
Premium Series Angled Drying and Storage Rack				
CPMU244875PDPKG	24" x 48" x 75"	128 Pellets and Bases or 16 GN 1/1 Food Pans	1	\$ 1,790.00
Angled Drying and Storage Cradle for 24" deep shelf only (Fits all Camshelving® lines)				
CSDR8	23 1/16" x 10 3/8" x 6 1/16"	—	1	48.65
CSDR84	23 1/16" x 10 3/8" x 6 1/16"	—	4	195.00

Drying Rack Color: Speckled Gray (480). **Drying Cradle Color:** Soft Gray (151).
*Rack height includes 5" casters.

Unit ships in



Premium Series Multi-Purpose Drying and Storage Racks

- For sheet pans, trays, cutting boards, food pans, storage containers, pots and pans and/or lids.
- Racks include vertical and angled drying cradles and may include 1 vented shelf plus shelf rails.

Holding Capacity Per Drying/Storage Tier

SHELF LENGTH	TRAYS	GN FULL SIZE FOOD PANS	PELLETS/BASES
36"	21	3	24
48"	28	4	32

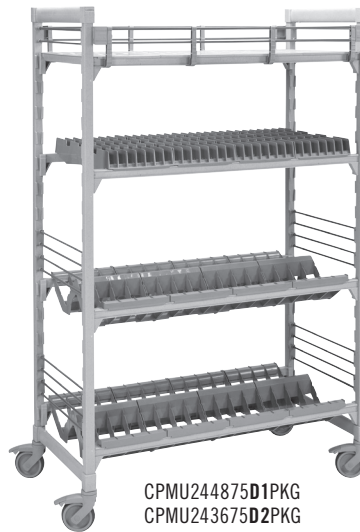

CPMU244875D1PKG
CPMU243675D2PKG



CPMU244875D3PKG
CPMU243675D4PKG

D1 and D2 Drying Racks Include 2 shelves of angled cradles, 1 shelf of vertical cradles, 1 vented shelf, 8 end rail kits and 1 full shelf rail kit.

D3 and D4 Drying Racks Include 2 shelves of angled cradles and 2 shelves of vertical cradles.

CODE	DIMENSIONS D x L x H*	CASE PACK	LIST PRICE EA.
CPMU244875D1PKG	24" x 48" x 75"	1	\$ 1,975.00
CPMU243675D2PKG	24" x 36" x 75"	1	1,730.00
CPMU244875D3PKG	24" x 48" x 75"	1	1,775.00
CPMU243675D4PKG	24" x 36" x 75"	1	1,365.00

Drying Rack Color: Speckled Gray (480). **Drying Cradle Shelf Rail Color:** Soft Gray (151).
*Height includes 5" casters.

D1 and D2 units ship in



D3 unit ships in



D4 unit ships in

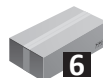

PREMIUM® SERIES DRYING AND STORAGE RACKS

Premium Series Dome Drying and Storage Rack

- For patient meal delivery domes.
- Cradle slot is 3 1/16" wide.



CSDDC24



For building custom racks, use the Custom Drying Rack/Cradle Reference Guide on page 87.

CODE	DIMENSIONS D x L x H*	HOLDING CAPACITY	CASE PACK	LIST PRICE EA.
Premium Series Dome Drying and Storage Rack				
CPMU243675DDPKG	24" x 36" x 75"	100 Domes	1	\$ 1,565.00
Dome Drying and Storage Cradle for 24" deep shelf only (Fits all Camshelving® lines)				
CSDDC24	24" x 16 1/2" x 3 3/8"	—	1	70.35
CSDDC245	24" x 16 1/2" x 3 3/8"	—	5	350.00

Drying Rack Color: Speckled Gray (480). **Drying Cradle Color:** Soft Gray (151).

*Rack height includes 5" casters.

Unit ships in



Premium Series Plate Cover Drying and Storage Rack

- For standard plate covers.
- Maximum plate cover dimensions
3" outside height,
10.8" inside diameter.

Fits Camwear Camcovers:

900CWNH, 1000CWNH, 1007CWNH,
1013CWNH.

Fits Versa Camcovers:

85SFVSNH 978SFVSNH, 86VSNH,
91VSNH, 913VSNH, 95VSNH, 99VSNH,
911VSNH, 100VSNH, 103VSNH,
105VSNH, 106VSNH, 110VSNH,
112VSNH.

CODE	DIMENSIONS D x L x H*	HOLDING CAPACITY	LIST PRICE EA.
CPMU243675D5PKG	24" x 36" x 75"	80 Covers	\$ 1,210.00

Shelving Color: Speckled Gray (480). **Drying Cradle Color:** Soft Gray (151).

*Height includes 5" casters.

Unit ships in



SECURITY AND UNDERCOUNTER UNITS

Premium® Series Full Wrap Security Cage Units

- Use to store valuable products behind locked doors.
- Can be used in freezers, coolers, kitchens or dry storage.
- Made of heavy-duty 304 stainless steel.
- Units include 2 vented shelves.
- Install Divider Panels directly onto shelves to organize product.
- Install additional vented or solid shelves without disassembling unit.
- Mobile unit includes premium swivel plastic casters, all with total locking brake. Locks swivel and motion.
- Maximum lock shackle diameter is 5/16". Lock not included.
- Ships knockdown (shelving unit and cage). Units ship in 1 box and include factory assembled post kits for quicker assembly. Cage ships with unit in a separate box.

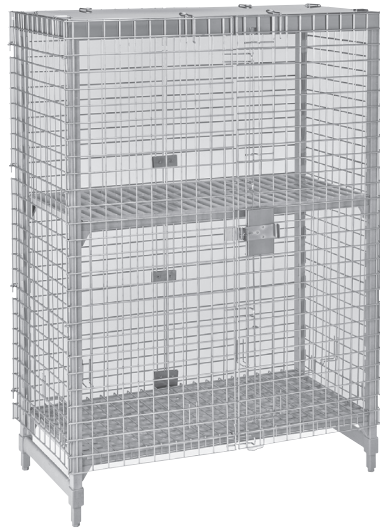

CODE	CPU244864SUPKG	CPMU244867SUPKG
DESCRIPTION	Full-wrap Stationary Security Unit	Full-wrap Mobile Security Unit
DIMENSION D x L x H	26¾" x 50¼" x 64½"	26¾" x 50¼" x 67¾"*
COLOR	Speckled Gray (480)	Speckled Gray (480)
LIST PRICE EA.	\$ 3,745.00	\$ 4,055.00

*Height includes 5" casters.

Units ship in  2

Elements® Series 2-Shelf Vented Undercounter Units

- Create storage in underutilized or hard-to-reach undercounter areas.
- Ideal for storing paper goods and non-perishable condiments.
- Choose from mobile or stationary units based on application/use.
- Mobile units include premium swivel plastic casters, all with total locking brake. Locks swivel and motion.
- Ships knockdown in 1 box with factory assembled post kits.



CODE	DIMENSIONS D x L x H*	LIST PRICE EA.
Stationary Units		
ESU183630V2	18" x 36" x 30"	\$ 315.00
ESU184830V2	18" x 48" x 30"	355.00
Mobile Units		
EMU142427V2	14" x 24" x 27¼"	540.00
EMU143627V2	14" x 36" x 27¼"	605.00
EMU144827V2	14" x 48" x 27¼"	645.00

Color: Brushed Graphite (580). *Height includes casters.

Units ship in  1

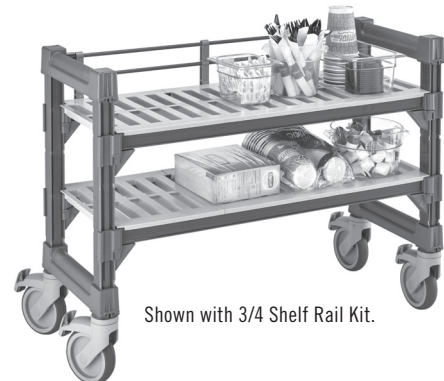

Shown with 3/4 Shelf Rail Kit.

WALL SHELVES AND SHELF EXTENDERS

Wall Shelves

Expand storage space in kitchens, above work stations and sinks. Features virtually indestructible I-beam supports that hold up to 150 lbs. per shelf. Durable polypropylene withstands temperatures up to 190°F, and will not rust or corrode. Snap fit rail design allows shelves to snap on and off for easy cleaning. Backsplash and marine front edge controls spills and cross contamination.

CODE	EXTERIOR DIM. L x W x H	LIST PRICE EA.
Solid Shelf		
CSWS1436SK	36" x 14" x 13½"	\$ 165.00
CSWS1448SK	48" x 14" x 13½"	189.00
CSWS1836SK	36" x 18" x 13½"	189.00
CSWS1848SK	48" x 18" x 13½"	208.00
Vented Shelf		
CSWS1436VK	36" x 14" x 13½"	165.00
CSWS1448VK	48" x 14" x 13½"	189.00
Shelf Extender		
CSWS36EK	35½" x 2" x 15½"	228.00
CSWS48EK	47½" x 2" x 15½"	340.00

Case Pack: 1 Wall Shelf Color: Speckled Gray (480).
Extender Peg Strip Color: Black (110).



Shelf Extenders ship in one carton with all hardware and includes:

LENGTH	PEG STRIPS	BRACKETS	HOOKS
36"	3	2	6
48"	3	3	9



Shelf Extenders

Convert empty wall space into a functional storage area. Use with or without Camshelving Wall Shelves. Peg strips withstand temperatures up to 190°F, and will not rust or corrode.

S-SERIES DUNNAGE RACKS

Keep frozen, cold or dry inventory 12" safely off the floor. One piece construction and sturdy legs provide strength and stability. Heavy duty polypropylene is safe to -36°F, and will not rust, corrode or bend. Choose slotted tops for maximum air circulation around perishable products stored in coolers or freezers. Solid tops catch spills for easy clean up. One Camlink included with each Dunnage Rack.



CODE	EXTERIOR DIMENSIONS H x D x W	LOAD CAPACITY	LIST PRICE EA.
Solid Top			
DRS30	12" x 21" x 30"	1,500 lbs.	\$ 249.00
DRS36	12" x 21" x 36"	1,500 lbs.	271.00
DRS48	12" x 21" x 48"	3,000 lbs.	325.00
DRS60	12" x 21" x 60"	3,000 lbs.	370.00
Slotted Top			
DRS300	12" x 21" x 30"	1,500 lbs.	249.00
DRS360	12" x 21" x 36"	1,500 lbs.	271.00
DRS480	12" x 21" x 48"	3,000 lbs.	325.00
DRS600	12" x 21" x 60"	3,000 lbs.	370.00
Camlink			
DRLNK	—	—	2.50

Dunnage Rack Case Pack: 1 Color: Speckled Gray (480), Dark Brown (131).

Camlink Case Pack: 6 Color: Black (110).

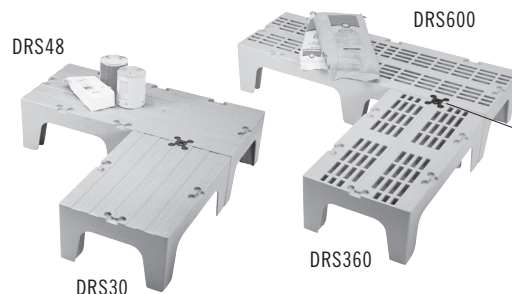

Camlink securely locks dunnage racks together for greater stability.

REPLACEMENT PARTS

Stationary Posts

CODE	DIMENSIONS	LIST PRICE EA.
Premium® Series		
CSP32	32"	\$ 25.40
CSP56	56"	42.10
CSP64	64"	47.00
CSP72	72"	48.40
CSP84	84"	57.95
Elements® Series		
EP30	30"	31.25
EP64	64"	37.05
EP72	72"	38.15
EP84	84"	45.75
Basics® Plus Series		
CBP64	64"	35.25
CBP72	72"	36.30
CBP84	84"	36.60

Mobile Posts

CODE	DIMENSIONS	LIST PRICE EA.
Premium Series		
CSPR35	35"	\$ 29.50
CSPR59	59"	44.35
CSPR67	67"	49.30
CSPR75	75"	50.85
Elements Series		
EMP27	27"	35.95
EMP70	70"	37.05
EMP78	78"	38.15

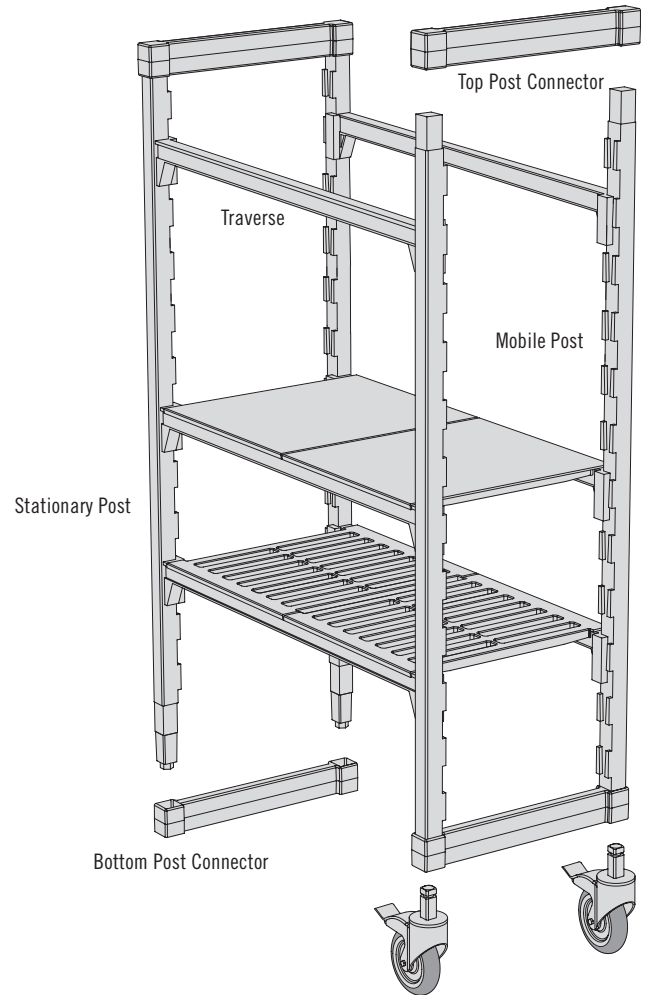

Traverses

LENGTH	SINGLE PACK CODE	LIST PRICE EA.	DOUBLE PACK CODE	LIST PRICE EA.
Premium Series				
24"	CPTR24	\$ 33.90	CPTR242PK	\$ 59.35
30"	CPTR30	36.65	CPTR302PK	64.25
36"	CPTR36	39.90	CPTR362PK	69.85
42"	CPTR42	42.65	CPTR422PK	76.15
48"	CPTR48	46.50	CPTR482PK	83.05
54"	CPTR54	50.50	CPTR542PK	90.10
60"	CPTR60	54.40	CPTR602PK	97.15
72"	CPTR72	59.35	—	—
Elements Series Stationary				
24"	ETR24	29.70	ETR242PK	56.60
30"	ETR30	32.15	ETR302PK	61.30
36"	ETR36	33.40	ETR362PK	63.75
42"	ETR42	35.70	ETR422PK	68.05
48"	ETR48	38.95	ETR482PK	74.25
54"	ETR54	42.20	ETR542PK	80.55
60"	ETR60	45.45	ETR602PK	86.85
72"	ETR72	52.00	—	—
Elements Series Mobile				
36"	EMTR36	45.70	EMTR362PK	72.45
42"	EMTR42	49.50	EMTR422PK	78.55
48"	EMTR48	53.30	EMTR482PK	84.55
54"	EMTR54	57.05	EMTR542PK	90.50
60"	EMTR60	60.90	EMTR602PK	96.60
Basics Plus Series				
30"	CBTR30	29.20	CBTR302PK	53.05
36"	CBTR36	29.40	CBTR362PK	53.45
42"	CBTR42	32.65	CBTR422PK	59.20
48"	CBTR48	35.70	CBTR482PK	64.90
54"	CBTR54	38.95	CBTR542PK	70.65
60"	CBTR60	41.90	CBTR602PK	76.15

Post Connectors

CODE	DESCRIPTION	LIST PRICE EA.
Premium Series		
CSPCT14	Top Post Connector 14"	\$ 10.75
CSPCB14	Bottom Post Connector 14"	10.75
CSPCT18	Top Post Connector 18"	13.40
CSPCB18	Bottom Post Connector 18"	13.40
CSPCT21	Top Post Connector 21"	15.00
CSPCB21	Bottom Post Connector 21"	15.00
CSPCT24	Top Post Connector 24"	15.70
CSPCB24	Bottom Post Connector 24"	15.70
Elements Series		
EPCT14	Top Post Connector 14"	10.10
EPCB14	Bottom Post Connector 14"	10.10
EPCT18	Top Post Connector 18"	12.20
EPCB18	Bottom Post Connector 18"	12.20
EPCT21	Top Post Connector 21"	13.35
EPCB21	Bottom Post Connector 21"	13.35
EPCT24	Top Post Connector 24"	14.05
EPCB24	Bottom Post Connector 24"	14.05
Basics Plus Series		
CBPCT18	Top Post Connector 18"	9.70
CBPCB18	Bottom Post Connector 18"	9.70
CBPCT21	Top Post Connector 21"	10.70
CBPCB21	Bottom Post Connector 21"	10.70
CBPCT24	Top Post Connector 24"	11.25
CBPCB24	Bottom Post Connector 24"	11.25

REPLACEMENT PARTS

Post Connector Collar Wedges

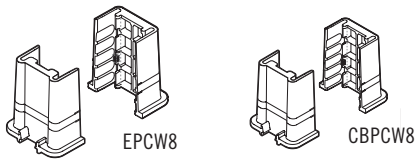

CODE	DESCRIPTION	LIST PRICE EA.
Elements® Series		
EPCW8	Bag of 8 Collar Wedges (4A and 4B)	\$ 6.70
Basics® Plus Series		
CBPCW8	Bag of 8 Collar Wedges (4A and 4B)	5.20

Corner Connectors

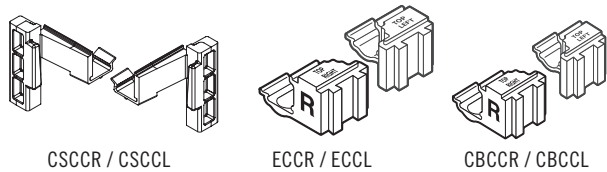

CODE	DESCRIPTION	LIST PRICE EA.
Premium® Series		
CSCCR	Right Corner Connector	\$ 3.95
CSCCL	Left Corner Connector	3.95
Elements Series		
ECCR	Right Corner Connector	3.15
ECCL	Left Corner Connector	3.15
Basics Plus Series		
CBCCR	Right Corner Connector	3.00
CBCCL	Left Corner Connector	3.00

Casters and Donut Bumpers

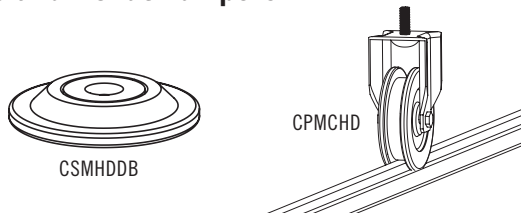

CODE	DESCRIPTION	LIST PRICE EA.
Premium Series		
CPMCWB	5" caster with total locking brake	\$ 72.15
CPMDB	Donut Bumper for CPMCWB	10.10
Premium Series High Density		
CPMCHD	5" grooved caster, no brake, includes bumper	58.35
CSMHDB	Donut Bumper only	25.00
Elements Series		
EMCWB	5" Caster with total locking brake/round toe pedal (for units sold before May 2021)	61.25
CSCWB	5" Caster with total locking brake/square toe pedal (for units sold after May 2021)	61.25
CSMHDB	Donut Bumper for EMCWB	25.00

Traverse Dovetails

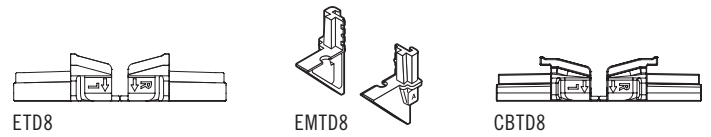

CODE	DESCRIPTION	LIST PRICE EA.
Elements Series — Stationary		
ETD8	Bag of 8 Dovetails, 4 each snap-apart, L and R	\$ 15.25
Elements Series — Mobile		
EMTD8	Bag of 8 Dovetails, 4 each, A and B	26.20
Basics Plus Series — Stationary Only		
CBTD8	Bag of 8 Dovetails, 4 each snap-apart, L and R	12.25

Post Leveling Foot

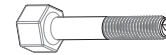

CODE	DESCRIPTION	LIST PRICE EA.
CSLF	Premium, Elements and Basics Plus Series	\$ 1.80

High Density Rails and Hardware

Track Joiner Kit H09010 includes:



Track Rail Joiner (x2)



Pan Head Screw (x8)



Star Washer (x8)

Track End Plate Kit H09011 includes:



Stainless Steel Leveling Foot (x8)



End Plate (x4)



Pan head Screw (x8)

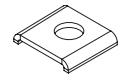

Plate Cap (x4)



Hex Nut (x4)



Star Washer (x8)

CODE	DESCRIPTION	LIST PRICE EA.
S09006	4.5' Rail Set	\$ 188.00
S09007	5' Rail Set	205.00
S09008	6' Rail Set	255.00
H09010	Track Rail Joiner Kit	59.95
H09011	Track End Plate Kit	188.00

REPLACEMENT PARTS

Wall Shelving

CODE	DESCRIPTION	LIST PRICE EA.
Premium® Series		
CSWS1836S	36" Wall Shelf Solid, 18" Width	\$ 100.85
CSWS1436S	36" Wall Shelf Solid, 14" Width	59.45
CSWS1436V	36" Wall Shelf Vented, 14" Width	57.60
CSWS1448S	48" Wall Shelf Solid, 14" Width	80.90
CSWS1448V	48" Wall Shelf Vented, 14" Width	71.05
CSWB14	14" Wall Shelf Bracket Kit	24.20
CSWB	18" Wall Shelf Bracket Kit	31.20
S06001	Peg Strip, 36" Long	51.45
S06002	Peg Strip, 48" Long	77.20
S06003	3-Peg Hooks	7.20
S06004	3-Peg Strip Screws	3.10
H06003	2-Lag Screws, 2-Washers	8.30
CSSE	Extender	13.60

Ultimate Sheet Pan Rack

CODE	DESCRIPTION	LIST PRICE EA.
Post Connector Frames and Wedges		
S19001	Bottom Post Connector Frame	\$ 113.00
S19002	Top Post Connector Frame	118.00
S19003	Wedges, Bag of 16	20.60
Rail Panel		
S19005	Rail Panel with 3" Spacing	56.65
S19006	Rail Panel with 1½" Spacing	53.55
Caster/Post Insert		
EMCWB	5" Caster with total locking brake/round toe pedal (for units sold before May 2021)	61.25
CSCWB	5" Caster with total locking brake/square toe pedal (for units sold after May 2021)	61.25
S19007	Caster Zinc 5" with Brake	51.50
S19008	Caster Zinc 5" No Brake	51.50
S19009	Caster Zinc 3" with Brake for Undercounter Units only	38.10
S19010	Caster Zinc 3" No Brake for Undercounter Units only	38.10
S19004	Post Insert 4 Sets	15.45

Full Wrap Security Cage

CODE	DESCRIPTION	LIST PRICE EA.
S13010	Clamp Plates, Stainless Steel	\$ 5.40
S13011	Bolt Plate w/ Nuts, Stainless Steel	8.00
S13012	Bottom Plates, Stainless Steel	8.80
S13013	Hinge Bushing (16 each)	17.50
S13014	Nut, Stainless Steel 10-32	2.30

Padlock shackle maximum diameter is 5/16".

Single Shelf Security Cage

CODE	DESCRIPTION	LIST PRICE EA.
S07005	Security Hook	\$ 10.60

Padlock shackle maximum diameter is 1/4".

Ultimate #10 Can Rack

CODE	DESCRIPTION	LIST PRICE EA.
UCRCANRB6	Brackets, Bag of 6	\$ 9.25



SHELF PLATES AND DRYING RACK SHELF CONFIGURATIONS

Shelf Plates for Camshelving Premium® Series and Elements® Series

SHELF PLATE DIMENSIONS	SOLID SHELF PLATE CODE	LIST PRICE EA.	VENTED SHELF PLATE CODE	LIST PRICE EA.	PLATE POSITIONING
14" Deep					
14" x 6"	CS146S	\$ 16.20	CS146V	\$ 16.00	A
14" x 11"	CS1411S	18.40	CS1411V	17.40	B
14" x 12"	CS1412S	19.30	CS1412V	18.50	C
14" x 18"	CS1418S	25.10	CS1418V	23.10	D
18" Deep					
18" x 6"	CS186S	16.70	CS186V	16.15	A
18" x 11"	CS1811S	19.90	CS1811V	18.15	B
18" x 12"	CS1812S	20.35	CS1812V	19.20	C
18" x 18"	CS1818S	30.65	CS1818V	18.60	D
21" Deep					
21" x 6"	CS216S	20.55	CS216V	18.60	A
21" x 11"	CS2111S	24.25	CS2111V	22.65	B
21" x 12"	CS2112S	26.55	CS2112V	23.75	C
21" x 18"	CS2118S	38.35	CS2118V	35.05	D
24" Deep					
24" x 6"	CS246S	22.85	CS246V	21.95	A
24" x 11"	CS2411S	27.50	CS2411V	24.15	B
24" x 12"	CS2412S	30.00	CS2412V	28.40	C
24" x 18"	CS2418S	39.65	CS2418V	36.50	D

TRAVERSE LENGTH	PLATE CONFIGURATION FOR 14", 18", 21", 24" DEEP SHELVEING				
24"	B	B			
30"	B	A	B		
36"	B	C	B		
42"	B	D	B		
48"	B	C	C	B	
54"	B	C	D	B	
60"	B	D	D	B	
72"	B	C	D	D	B

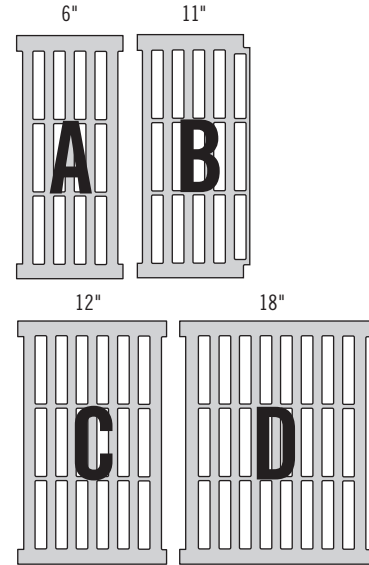

(18" available for Premium and Elements Series only.)

Shelf Plates for Camshelving Basics® Plus Series

SHELF PLATE DIMENSIONS	SOLID SHELF PLATE CODE	LIST PRICE EA.	VENTED SHELF PLATE CODE	LIST PRICE EA.	PLATE POSITIONING
18" Deep					
18" x 6"	CBSP186S	\$ 16.70	CBSP186V	\$ 12.90	A
18" x 11"	CBSP1811S	19.50	CBSP1811V	14.55	B
18" x 12"	CBSP1812S	20.65	CBSP1812V	15.40	C
21" Deep					
21" x 6"	CBSP216S	19.30	CBSP216V	14.85	A
21" x 11"	CBSP2111S	23.35	CBSP2111V	18.05	B
21" x 12"	CBSP2112S	25.00	CBSP2112V	19.00	C
24" Deep					
24" x 6"	CBSP246S	22.85	CBSP246V	17.65	A
24" x 11"	CBSP2411S	25.35	CBSP2411V	19.35	B
24" x 12"	CBSP2412S	29.25	CBSP2412V	22.75	C

TRAVERSE LENGTH	PLATE CONFIGURATION FOR 18", 21", 24" DEEP BASIC PLUS SHELVEING				
30"	B	A	B		
36"	B	C	B		
42"	B	A	C	B	
48"	B	C	C	B	
54"	B	A	C	C	B
60"	B	C	C	C	B

Camshelving Premium Series Custom Drying Rack/Cradle Reference Guide

Unit Length	Maximum Number of Drying Cradles per Tier			Unused Space per Tier with maximum number of cradles installed			Number of Products per Tier		
	DOMES CSDDC24	ANGLED CSDR8	VERTICAL CSDR7	DOMES CSDDC24	ANGLED CSDR8	VERTICAL CSDR7	DOMES	BASES	TRAYS
24"	1	1	2	4.375"	10.25"	0"	10	8	14
30"	1	2	2	10.375"	6.25"	6.25"	10	16	14
36"	2	3	3	0"	2.62"	2.62"	20	24	21
42"	2	3	3	6"	8"	8"	20	24	21
48"	2	4	4	12"	3.75"	3.75"	20	32	28
54"*	3	4	4	1.75"	9.75"	9.75"	30	32	28
60"*	3	5	5	7.75"	5.5"	5.5"	30	40	35
72"*	4	6	6	3.375"	7.25"	7.25"	40	48	42

*Recommended for stationary units only

FREE CAMSHELVING® DESIGN SERVICE

Take the guesswork out of creating your perfect shelving layout. Let our expert shelving consultants prepare a free layout that optimizes your space to create the most storage options.

Here's what you'll get:

- 2D Floor Plan
- 3D Floor Plan
- Itemized product list by room/area
- All within 48 business-day hours

It's Simple! To Get Started, Please Provide:

- Project Name
- Storage Room Type (freezer / cooler)
- Room(s) Dimensions (L x W x H)
- Doorway / Entryway Location & Dimension
- Obstructions (condenser / pipes)
- Additional Preferences / Requirements

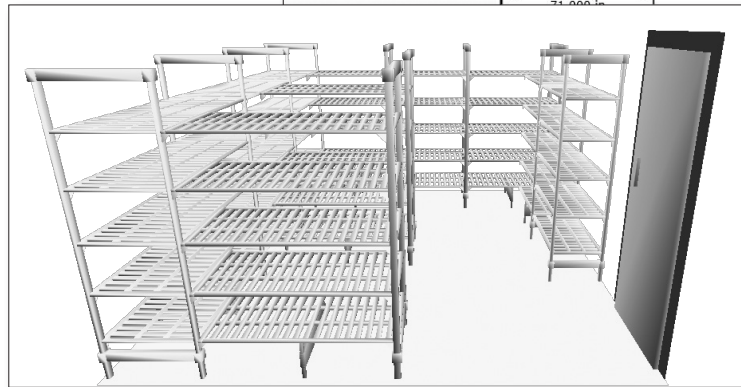
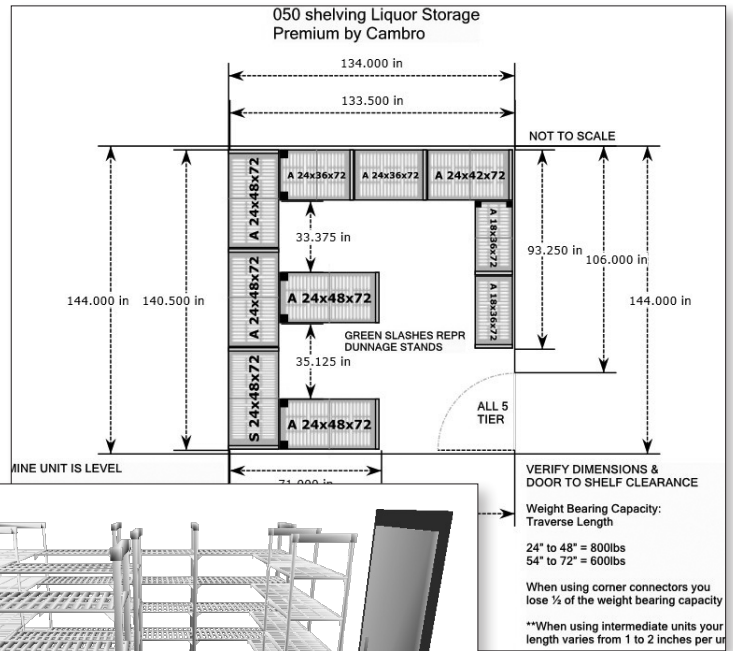

Request a Free 3D Shelving Layout

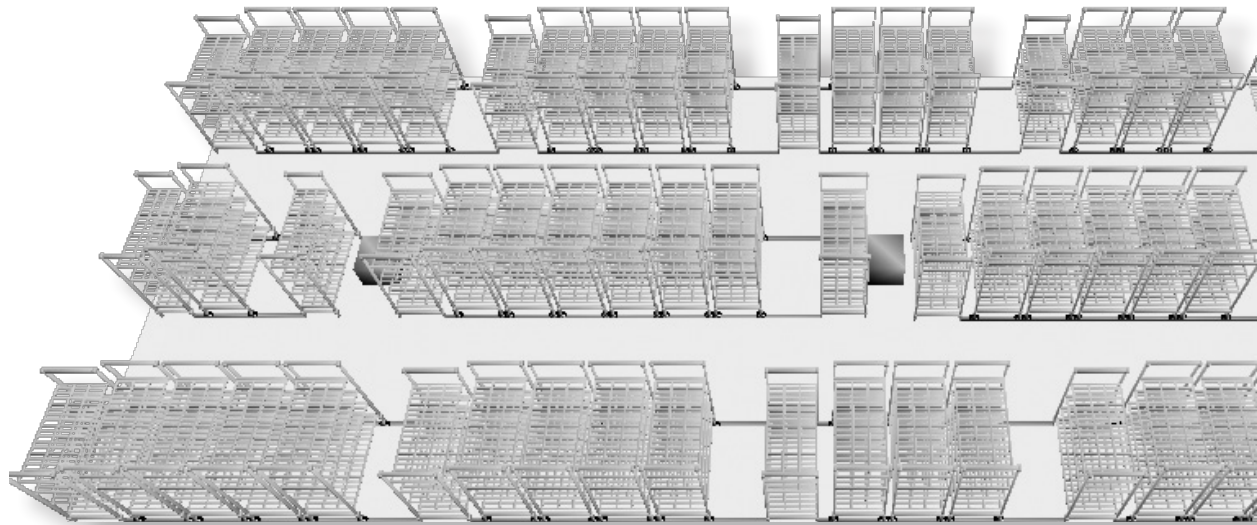

Email shelving@cambro.com or call TOLL FREE (877) 737-0663.