

CAMSHELVING®

PREMIUM

series

STATIONARY | MOBILE | HIGH DENSITY

WHY CHOOSE PREMIUM?

In high volume foodservice operations with frequent deliveries and constant loading and off-loading of products, stability, strength and sanitary storage should never be compromised. Premium Series does precisely what it was designed to do – hold the heaviest products with the roughest handling, in any environment. It is also the easiest to clean and adjust.

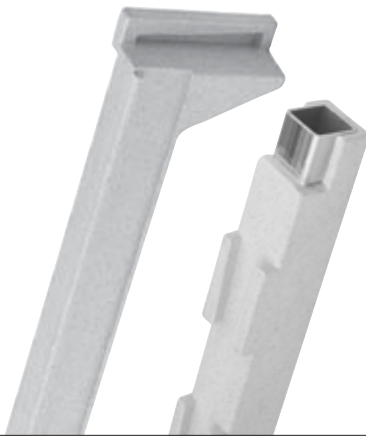

camguard
ANTIMICROBIAL SHELF PLATES



Post Connectors, Corner Connectors, Floor Fastener, Wall Fastener, Identification Tags, Full Wrap Security Cage, Single Shelf Security Cage, Ultimate #10 Can Rack, Shelf Rails, Shelf Divider Bars, High Density Track and Extension Kits are not NSF Listed.

CAMSHELVING® PREMIUM SERIES

Stationary Unit Sizes

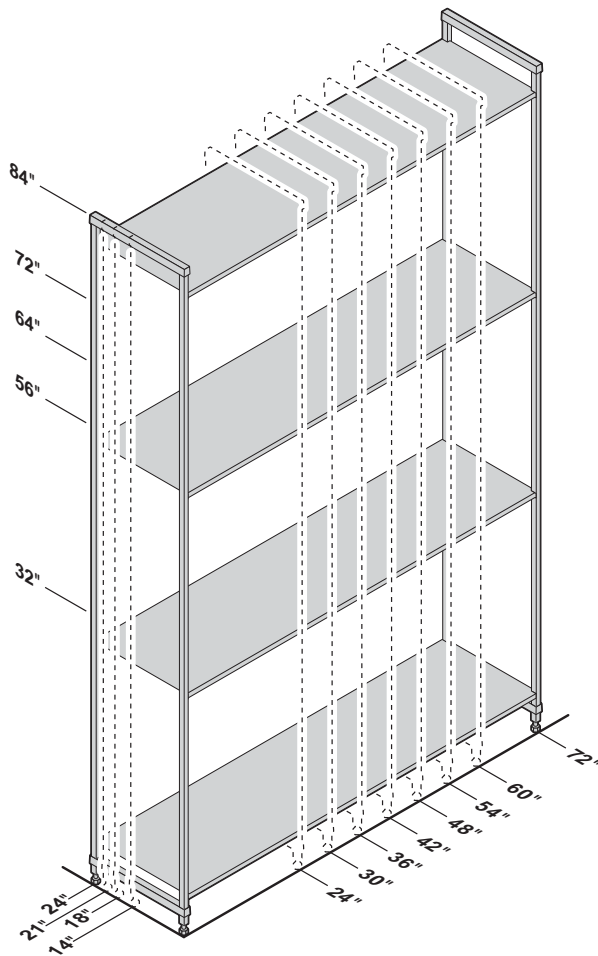

Mobile Unit Sizes

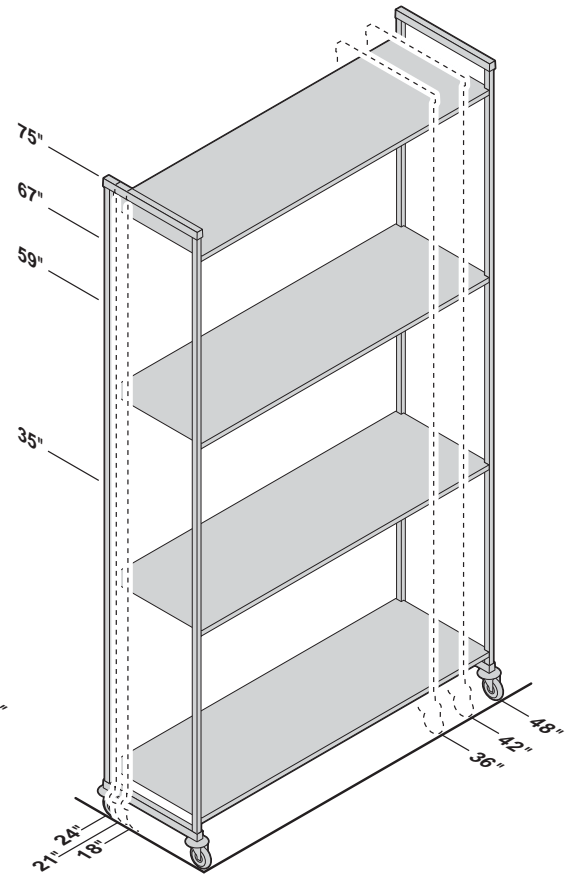

Weight Bearing Capacity

Weight must be evenly distributed across the entire shelf.

		UNIT LENGTH 24" – 48"	UNIT LENGTH 54" – 72"
SINGLE UNIT	Unit only	2000 lbs.	2000 lbs.
	Shelf only	800	600
	Unit with dunnage stand*	2400	2300
	Bottom shelf with dunnage stand*	1200	900
CORNER UNIT*** With 2 Dunnage Stands required	Unit only	1800	—
	Shelf only	400	—
	Bottom shelf with dunnage stands*	600	—
MOBILE UNIT	Unit only**	750	—

*Dunnage Stands add stability and increase weight bearing capacity on bottom shelf only. Highly recommended for Starter Units 54" and longer, all Corner Units, U-Shape Units and units specified for heavier loads. (See Overall Length Quick Reference Guide).

**Due to the weight bearing capacity of casters, maximum weight load on an entire Mobile Unit is 750 lbs.

*** Corner connectors are for use only with shelves 24" - 48" long.



CAMSHELVING® PREMIUM SERIES – STARTER, ADD-ON AND MOBILE UNITS

V4 4-Shelf Vented Stationary Starter and Add-On Units

HEIGHTS	DEPTHS	LENGTHS	
3	3	8	
64"	18"	24"	48"
72"	21"	30"	54"
84"	24"	36"	60"
		42"	72"

V5 5-Shelf Vented Stationary Starter and Add-On Units

HEIGHTS	DEPTHS	LENGTHS	
3	3	8	
64"	18"	24"	48"
72"	21"	30"	54"
84"	24"	36"	60"
		42"	72"

S4 4-Shelf Solid Stationary Starter and Add-On Units

HEIGHTS	DEPTHS	LENGTHS	
3	3	8	
64"	18"	24"	48"
72"	21"	30"	54"
84"	24"	36"	60"
		42"	72"

S5 5-Shelf Solid Stationary Starter and Add-On Units

HEIGHT	DEPTHS	LENGTHS	
1	3	8	
84"	18"	24"	48"
	21"	30"	54"
	24"	36"	60"
		42"	72"

VS4 4-Shelf Vented and Solid Stationary Starter and Add-On Units (3 vented + 1 solid)

HEIGHTS	DEPTHS	LENGTHS	
3	3	8	
64"	18"	24"	48"
72"	21"	30"	54"
84"	24"	36"	60"
		42"	72"

VS5 5-Shelf Vented and Solid Stationary Starter and Add-On Units (4 vented + 1 solid)

HEIGHT	DEPTHS	LENGTHS	
1	3	8	
84"	18"	24"	48"
	21"	30"	54"
	24"	36"	60"
		42"	72"

V4 4-Shelf Vented Mobile Starter Units

HEIGHTS*	DEPTHS	LENGTHS	
2	3	3	
67"	18"	36"	
75"	21"	42"	
	24"	48"	

V5 5-Shelf Vented Mobile Starter Units

HEIGHTS*	DEPTHS	LENGTHS	
2	3	3	
67"	18"	36"	
75"	21"	42"	
	24"	48"	

* Includes 5" casters.



Visit the Camshelving® website at www.cambro.com/camshelving for product information, assembly videos and design layouts, or to view or download the Camshelving Specification and Price List.

PREMIUM
SERIES

V4 4-SHELF VENTED UNITS

64"
HEIGHT

Starter units include 2 factory assembled post kits and shelves. Add-on units include 1 factory assembled post kit and shelves. Units ship complete in 1 box.

Starter

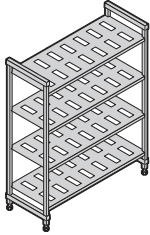

Add-On

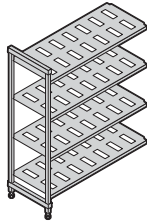

18"
DEPTH

DIMENSIONS D x L x H	CODE	LIST PRICE EA.	CODE	LIST PRICE EA.
18" x 24" x 64"	CPU182464V4	\$ 512.60	CPA182464V4	\$ 397.40
18" x 30" x 64"	CPU183064V4	579.60	CPA183064V4	464.40
18" x 36" x 64"	CPU183664V4	617.00	CPA183664V4	501.80
18" x 42" x 64"	CPU184264V4	692.00	CPA184264V4	576.80
18" x 48" x 64"	CPU184864V4	719.00	CPA184864V4	603.80
18" x 54" x 64"	CPU185464V4	793.40	CPA185464V4	678.20
18" x 60" x 64"	CPU186064V4	844.40	CPA186064V4	729.20
18" x 72" x 64"	CPU187264V4PKG	944.20	CPA187264V4PKG	829.00

PKG units ship same as 84" units.

21"
DEPTH

21" x 24" x 64"	CPU212464V4	\$ 552.60	CPA212464V4	\$ 434.40
21" x 30" x 64"	CPU213064V4	628.40	CPA213064V4	510.20
21" x 36" x 64"	CPU213664V4	673.20	CPA213664V4	555.00
21" x 42" x 64"	CPU214264V4	758.40	CPA214264V4	640.20
21" x 48" x 64"	CPU214864V4	790.60	CPA214864V4	672.40
21" x 54" x 64"	CPU215464V4	875.40	CPA215464V4	757.20
21" x 60" x 64"	CPU216064V4	933.60	CPA216064V4	815.40
21" x 72" x 64"	CPU217264V4PKG	1,049.40	CPA217264V4PKG	931.20

PKG units ship same as 84" units.

24"
DEPTH

24" x 24" x 64"	CPU242464V4	\$ 561.60	CPA242464V4	\$ 442.60
24" x 30" x 64"	CPU243064V4	640.80	CPA243064V4	521.80
24" x 36" x 64"	CPU243664V4	691.20	CPA243664V4	572.20
24" x 42" x 64"	CPU244264V4	766.80	CPA244264V4	647.80
24" x 48" x 64"	CPU244864V4	817.00	CPA244864V4	698.00
24" x 54" x 64"	CPU245464V4	887.80	CPA245464V4	768.80
24" x 60" x 64"	CPU246064V4	940.00	CPA246064V4	821.00
24" x 72" x 64"	CPU247264V4PKG	1,064.80	CPA247264V4PKG	945.80

PKG units ship same as 84" units.

PREMIUM
SERIES

V4 4-SHELF VENTED UNITS

72"
HEIGHT

Starter units include 2 factory assembled post kits and shelves. Add-on units include 1 factory assembled post kit and shelves. Units ship complete in 1 box.

Starter

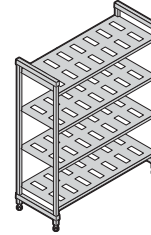

Add-On

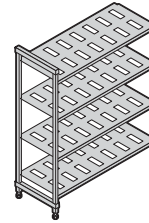

DIMENSIONS D x L x H	CODE	LIST PRICE EA.	CODE	LIST PRICE EA.
18" x 24" x 72"	CPU182472V4	\$ 517.70	CPA182472V4	\$ 399.95
18" x 30" x 72"	CPU183072V4	584.70	CPA183072V4	466.95
18" x 36" x 72"	CPU183672V4	622.10	CPA183672V4	504.35
18" x 42" x 72"	CPU184272V4	697.10	CPA184272V4	579.35
18" x 48" x 72"	CPU184872V4	724.10	CPA184872V4	606.35
18" x 54" x 72"	CPU185472V4	798.50	CPA185472V4	680.75
18" x 60" x 72"	CPU186072V4	849.50	CPA186072V4	731.75
18" x 72" x 72"	CPU187272V4PKG	949.30	CPA187272V4PKG	831.55

21" x 24" x 72"	CPU212472V4	\$ 557.30	CPA212472V4	\$ 436.75
21" x 30" x 72"	CPU213072V4	633.10	CPA213072V4	512.55
21" x 36" x 72"	CPU213672V4	677.90	CPA213672V4	557.35
21" x 42" x 72"	CPU214272V4	763.10	CPA214272V4	642.55
21" x 48" x 72"	CPU214872V4	795.30	CPA214872V4	674.75
21" x 54" x 72"	CPU215472V4	880.10	CPA215472V4	759.55
21" x 60" x 72"	CPU216072V4	938.30	CPA216072V4	817.75
21" x 72" x 72"	CPU217272V4PKG	1,054.10	CPA217272V4PKG	933.55

24" x 24" x 72"	CPU242472V4	\$ 567.00	CPA242472V4	\$ 445.30
24" x 30" x 72"	CPU243072V4	646.20	CPA243072V4	524.50
24" x 36" x 72"	CPU243672V4	696.60	CPA243672V4	574.90
24" x 42" x 72"	CPU244272V4	772.20	CPA244272V4	650.50
24" x 48" x 72"	CPU244872V4	822.40	CPA244872V4	700.70
24" x 54" x 72"	CPU245472V4	893.20	CPA245472V4	771.50
24" x 60" x 72"	CPU246072V4	945.40	CPA246072V4	823.70
24" x 72" x 72"	CPU247272V4PKG	1,070.20	CPA247272V4PKG	948.50

Color: Speckled Gray (480).

PREMIUM
SERIES

V5PKG 5-SHELF VENTED UNITS

84"
HEIGHT

Due to the unit weight, 84" units ship in separate boxes. Starter units include 2 post kits and 1 box of shelves. Add on units include 1 post kit and 1 box of shelves. Post kits require assembly.

Starter

Add-On

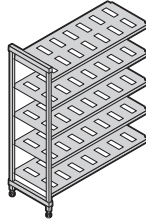
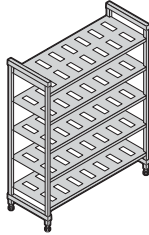

18"
DEPTH

DIMENSIONS D x L x H	CODE	LIST PRICE EA.	CODE	LIST PRICE EA.
18" x 24" x 84"	CPU182484V5PKG	\$ 624.85	CPA182484V5PKG	\$ 488.80
18" x 30" x 84"	CPU183084V5PKG	708.60	CPA183084V5PKG	572.55
18" x 36" x 84"	CPU183684V5PKG	755.35	CPA183684V5PKG	619.30
18" x 42" x 84"	CPU184284V5PKG	849.10	CPA184284V5PKG	713.05
18" x 48" x 84"	CPU184884V5PKG	882.85	CPA184884V5PKG	746.80
18" x 54" x 84"	CPU185484V5PKG	975.85	CPA185484V5PKG	839.80
18" x 60" x 84"	CPU186084V5PKG	1,039.60	CPA186084V5PKG	903.55
18" x 72" x 84"	CPU187284V5PKG	1,164.35	CPA187284V5PKG	1,028.30

21"
DEPTH

21" x 24" x 84"	CPU212484V5PKG	\$ 672.95	CPA212484V5PKG	\$ 534.10
21" x 30" x 84"	CPU213084V5PKG	767.70	CPA213084V5PKG	628.85
21" x 36" x 84"	CPU213684V5PKG	823.70	CPA213684V5PKG	684.85
21" x 42" x 84"	CPU214284V5PKG	930.20	CPA214284V5PKG	791.35
21" x 48" x 84"	CPU214884V5PKG	970.45	CPA214884V5PKG	831.60
21" x 54" x 84"	CPU215484V5PKG	1,076.45	CPA215484V5PKG	937.60
21" x 60" x 84"	CPU216084V5PKG	1,149.20	CPA216084V5PKG	1,010.35
21" x 72" x 84"	CPU217284V5PKG	1,293.95	CPA217284V5PKG	1,155.50

24"
DEPTH

24" x 24" x 84"	CPU242484V5PKG	\$ 684.40	CPA242484V5PKG	\$ 544.45
24" x 30" x 84"	CPU243084V5PKG	783.40	CPA243084V5PKG	643.45
24" x 36" x 84"	CPU243684V5PKG	846.40	CPA243684V5PKG	706.45
24" x 42" x 84"	CPU244284V5PKG	940.90	CPA244284V5PKG	800.95
24" x 48" x 84"	CPU244884V5PKG	1,003.65	CPA244884V5PKG	863.70
24" x 54" x 84"	CPU245484V5PKG	1,092.15	CPA245484V5PKG	952.20
24" x 60" x 84"	CPU246084V5PKG	1,157.40	CPA246084V5PKG	1,017.45
24" x 72" x 84"	CPU247284V5PKG	1,313.40	CPA247284V5PKG	1,173.45

Color: Speckled Gray (480).

1.800.833.3003

PREMIUM
SERIES

V4 4-SHELF VENTED MOBILE UNITS

Mobile starter units include 2 factory assembled mobile post kits, shelves and 4 premium swivel casters with total locking brake. Units ship complete in 1 box.

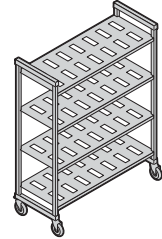

67"
HEIGHT

18"
DEPTH

CODE	DIMENSIONS D x L x H*	LIST PRICE EA.
CPMU183667V4	18" x 36" x 67"	\$ 914.90
CPMU184267V4	18" x 42" x 67"	989.90
CPMU184867V4	18" x 48" x 67"	1,016.90

21"
DEPTH

CPMU213667V4	21" x 36" x 67"	\$ 970.80
CPMU214267V4	21" x 42" x 67"	1,056.00
CPMU214867V4	21" x 48" x 67"	1,088.20

24"
DEPTH

CPMU243667V4	24" x 36" x 67"	\$ 988.90
CPMU244267V4	24" x 42" x 67"	1,064.50
CPMU244867V4	24" x 48" x 67"	1,114.70

75"
HEIGHT

18"
DEPTH

CODE	DIMENSIONS D x L x H*	LIST PRICE EA.
CPMU183675V4	18" x 36" x 75"	\$ 919.90
CPMU184275V4	18" x 42" x 75"	994.90
CPMU184875V4	18" x 48" x 75"	1,021.90

21"
DEPTH

CPMU213675V4	21" x 36" x 75"	\$ 975.90
CPMU214275V4	21" x 42" x 75"	1,061.10
CPMU214875V4	21" x 48" x 75"	1,093.30

24"
DEPTH

CPMU243675V4	24" x 36" x 75"	\$ 994.30
CPMU244275V4	24" x 42" x 75"	1069.90
CPMU244875V4	24" x 48" x 75"	1120.10

*Includes 5" casters.

CAMBRO USA-SHELVING

107

CAMSHELVING® PREMIUM SERIES

Corner Connectors

Unique patented design ensures maximum shelf space utilization. Use 1 set per shelf to connect starter and add-on units in corners. Connect 4 or 5 intermediate shelves between 2 starter units (2 sets required per shelf). Available as a single set or 8 or 10 set packs.

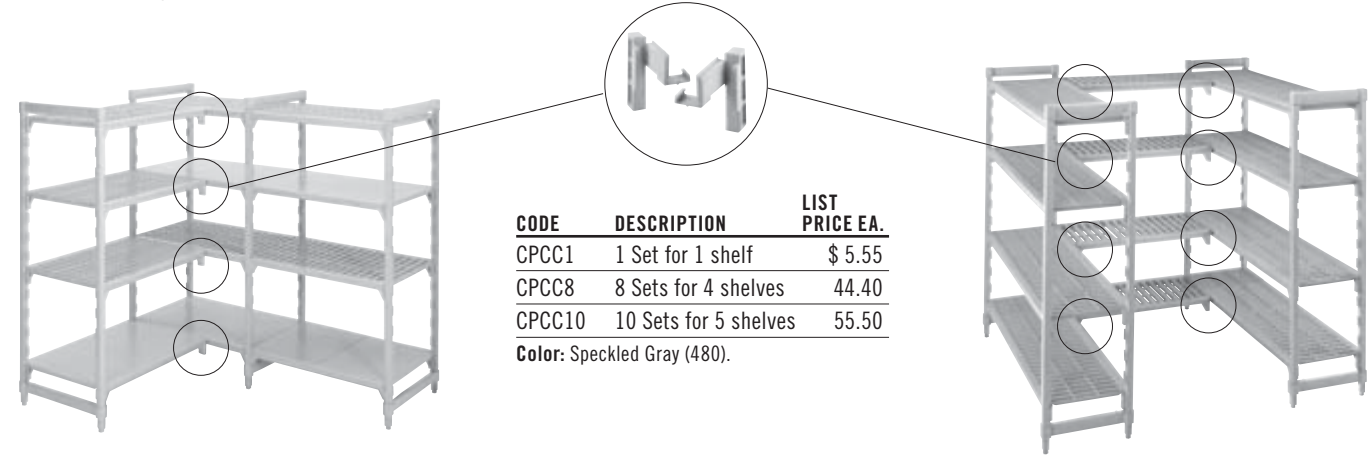

CODE	DESCRIPTION	LIST PRICE EA.
CPCC1	1 Set for 1 shelf	\$ 5.55
CPCC8	8 Sets for 4 shelves	44.40
CPCC10	10 Sets for 5 shelves	55.50

Color: Speckled Gray (480).

Bottom Shelf Dunnage Stands

Increase weight bearing capacity on bottom shelf only. Add to any shelf length. Highly recommended for starter units 54" and longer and all corner units, intermediate units and units specified for heavier load volume on and off bottom shelves.

CODE	DIMENSIONS D x H	LIST PRICE EA.
Dunnage Stand - Low		
CPDS14H6	14" x 7½"	\$ 73.25
CPDS18H6	18" x 7½"	75.65
CPDS21H6	21" x 7½"	77.55
CPDS24H6	24" x 7½"	79.50
Dunnage Stand - Tall		
CPDS14H11	14" x 11¾"	79.30
CPDS18H11	18" x 11¾"	81.75
CPDS21H11	21" x 11¾"	83.65
CPDS24H11	24" x 11¾"	85.60

Case Pack: 1 **Color:** Speckled Gray (480).

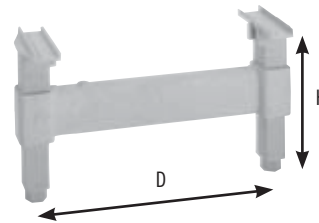

Shelf Traverses

Available in single or double packs. Use a single set to add an open shelf for divider bars or drying racks. Add single traverses onto back posts for extra support when placing rolling equipment under the first shelf.

LENGTH	SINGLE PACK CODE*	LIST PRICE EA.	DOUBLE PACK CODE**	LIST PRICE EA.
24"	CPTR24	\$ 32.30	CPTR242PK	\$ 56.50
30"	CPTR30	34.90	CPTR302PK	61.20
36"	CPTR36	38.00	CPTR362PK	66.50
42"	CPTR42	40.60	CPTR422PK	72.50
48"	CPTR48	44.30	CPTR482PK	79.10
54"	CPTR54	48.10	CPTR542PK	85.80
60"	CPTR60	51.80	CPTR602PK	92.50
72"	CPTR72	56.50	—	—

*Case Pack: 1 **Case Pack: 2 **Color:** Speckled Gray (480).



HIGH DENSITY STORAGE FLOOR TRACK SYSTEM

Maximize storage capacity by creating storage aisles in all available space. This simple system is composed of stationary starter units anchored to a raised floor track system at both ends with high density mobile units installed in between. Easy to install track requires no drilling or gluing.



Increases Storage Capacity Up To

50%

High Density Mobile Units are available with factory assembled post kits, vented or solid shelves and high density casters and bumpers. Full track and extension kits ship complete with required hardware. Stationary Starter Units are required to anchor the system at both ends. Choose from a wide selection of sizes with 4 or 5 shelves to maximize storage space. (see Premium Series spec pages).

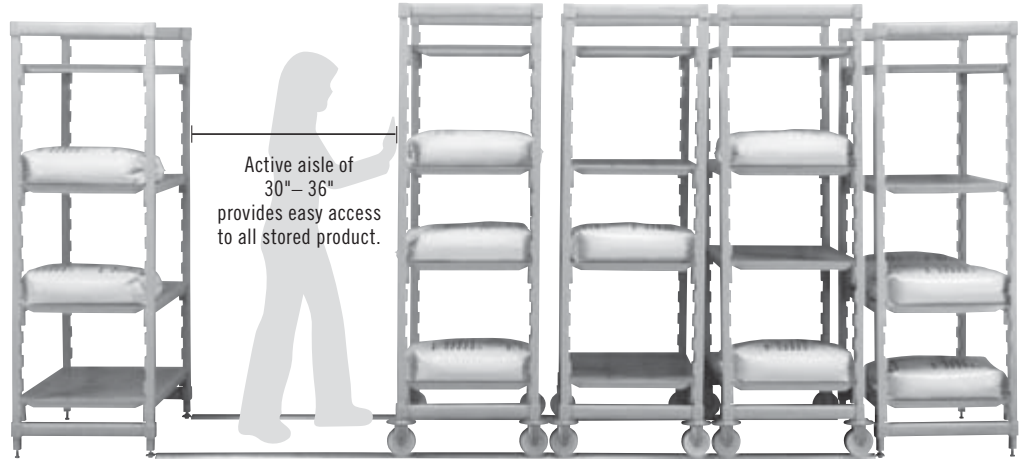

Stationary Unit*

High Density Mobile Units

Stationary Unit

Raised Floor Track provides a smooth and level surface to easily roll mobile units. Raised track ensures dirt will not get trapped and is easy to clean. Aluminum track and stainless steel hardware are rust resistant.



Grooved casters roll easily and securely on raised track.



Raised track connects easily to the bottom of a stationary unit that works as a system anchor. No bolts, no glue or drilling into the floor are required. Easy and fast set up.

*It is recommended to use a stationary unit for every 15' of track to further stabilize the system.

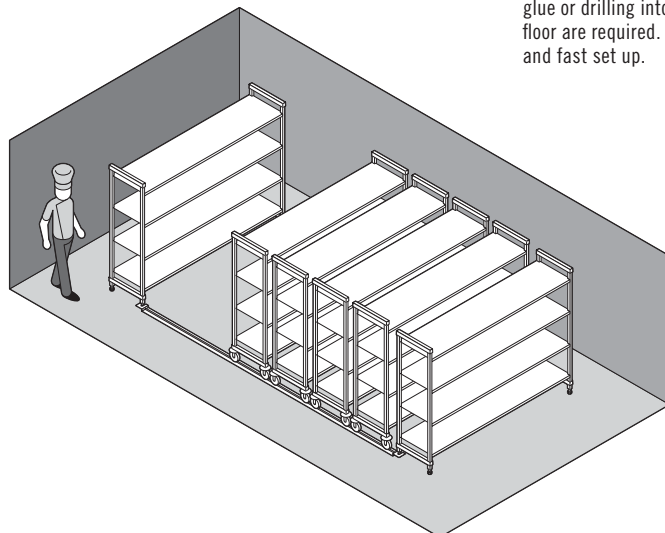
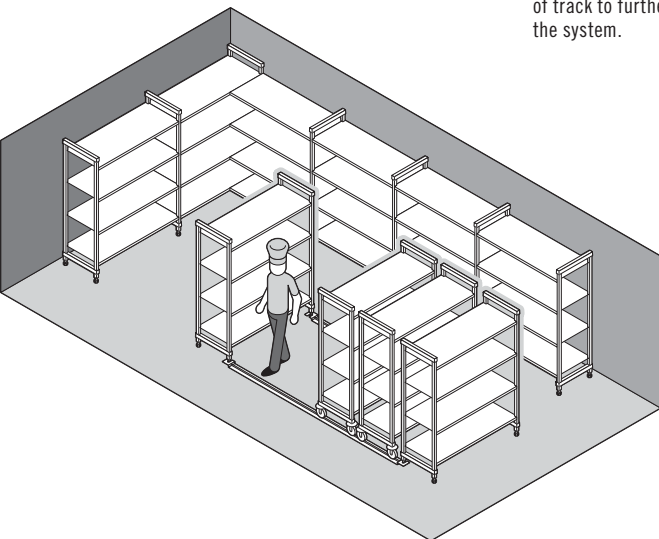

V4

4-SHELF VENTED HIGH DENSITY MOBILE UNITS

S4

4-SHELF SOLID HIGH DENSITY MOBILE UNITS

Units include 2 factory assembled mobile post kits, 4 shelves, 4 high density casters and 4 high density bumpers. Units ship complete in 1 box.

67"
HEIGHT

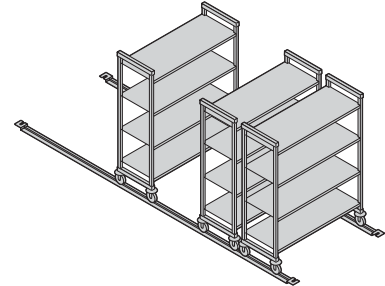
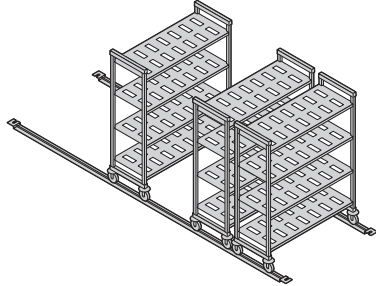

21"
DEPTH

CODE	DIMENSIONS D x L x H*	LIST PRICE EA.
CPHU213667V4	21" x 36" x 67"	\$ 992.50
CPHU214267V4	21" x 42" x 67"	1,077.70
CPHU214867V4	21" x 48" x 67"	1,109.90
CPHU215467V4	21" x 54" x 67"	1,194.70
CPHU216067V4	21" x 60" x 67"	1,252.90

CODE	DIMENSIONS D x L x H*	LIST PRICE EA.
CPHU213667S4	21" x 36" x 67"	\$ 1,016.10
CPHU214267S4	21" x 42" x 67"	1,103.10
CPHU214867S4	21" x 48" x 67"	1,144.50
CPHU215467S4	21" x 54" x 67"	1,230.70
CPHU216067S4	21" x 60" x 67"	1,290.70

24"
DEPTH

CPHU243667V4	24" x 36" x 67"	\$ 1,010.70
CPHU244267V4	24" x 42" x 67"	1,086.30
CPHU244867V4	24" x 48" x 67"	1,136.50
CPHU245467V4	24" x 54" x 67"	1,207.30
CPHU246067V4	24" x 60" x 67"	1,259.50

CPHU243667S4	24" x 36" x 67"	\$ 1,043.50
CPHU244267S4	24" x 42" x 67"	1,120.10
CPHU244867S4	24" x 48" x 67"	1,174.10
CPHU245467S4	24" x 54" x 67"	1,251.50
CPHU246067S4	24" x 60" x 67"	1,310.10

75"
HEIGHT

21"
DEPTH

CODE	DIMENSIONS D x L x H*	LIST PRICE EA.
CPHU213675V4	21" x 36" x 75"	\$ 997.70
CPHU214275V4	21" x 42" x 75"	1,082.90
CPHU214875V4	21" x 48" x 75"	1,115.10
CPHU215475V4	21" x 54" x 75"	1,199.90
CPHU216075V4	21" x 60" x 75"	1,258.10

CODE	DIMENSIONS D x L x H*	LIST PRICE EA.
CPHU213675S4	21" x 36" x 75"	\$ 1,021.30
CPHU214275S4	21" x 42" x 75"	1,108.30
CPHU214875S4	21" x 48" x 75"	1,149.70
CPHU215475S4	21" x 54" x 75"	1,235.90
CPHU216075S4	21" x 60" x 75"	1,295.90

24"
DEPTH

CPHU243675V4	24" x 36" x 75"	\$ 1,016.00
CPHU244275V4	24" x 42" x 75"	1,091.60
CPHU244875V4	24" x 48" x 75"	1,141.80
CPHU245475V4	24" x 54" x 75"	1,212.60
CPHU246075V4	24" x 60" x 75"	1,264.80

CPHU243675S4	24" x 36" x 75"	\$ 1,048.80
CPHU244275S4	24" x 42" x 75"	1,125.40
CPHU244875S4	24" x 48" x 75"	1,179.40
CPHU245475S4	24" x 54" x 75"	1,256.80
CPHU246075S4	24" x 60" x 75"	1,315.40

Color: Speckled Gray (480). *Includes 5" casters.

Full Track and Extension Kits

Aluminum raised track kits and track extensions ship complete in 1 box. Each kit includes all stainless steel hardware necessary to complete a floor installation.

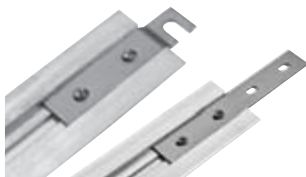
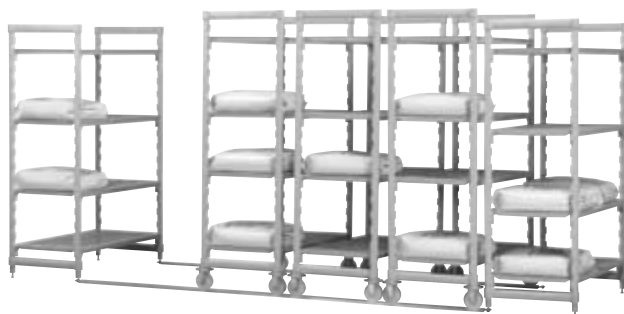

It is highly recommended to install a stationary starter unit every 15' of track to further stabilize the system.

CODE	DESCRIPTION	CASE PACK	LIST PRICE EA.
Full Track Kit			
CSMHDTK10	10' Track for 3 Mobile Units*	1	\$ 638.60
CSMHDTK12	12' Track for 4 Mobile Units*	1	736.45
CSMHDTK145	14.5' Track for 5 Mobile Units*	1	829.15
Track Extension Kit			
CSMHDTKE4	4.5' Track Extension	1	240.90
CSMHDTKE5	5' Track Extension	1	257.25
CSMHDTKE6	6' Track Extension	1	305.40

Color: Silver (000). *Based on 24" deep mobile units.

High Density Caster with Donut Bumper



CODE	SIZE	LIST PRICE EA.
CPMCHD	5"	\$ 55.55
Case Pack: 2		Color: Gray (000).

