

GAS DECK OVENS INSTALLATION & OPERATING MANUAL

**MODELS: MB42, MB60, MB236, MB260, MB866,
SD236, SD248, SD260, SD448, SD660, SD1048, SD1060, SD866, SD10866, WF42, WF60**

FOR YOUR SAFETY

DO NOT STORE OR USE GASOLINE OR OTHER FLAMMABLE VAPORS AND LIQUIDS IN THE VICINITY OF THIS OR ANY APPLIANCE.

FOR YOUR SAFETY

POST INSTRUCTIONS TO BE FOLLOWED IN THE EVENT THE USER SMELLS GAS IN A PROMINENT LOCATION. THIS INFORMATION SHALL BE OBTAINED BY CONSULTING YOUR LOCAL GAS SUPPLIER

WARNING

IMPROPER INSTALLATION, ADJUSTMENT, ALTERATION, SERVICE OR MAINTENANCE CAN CAUSE PROPERTY DAMAGE, INJURY, OR DEATH. READ THE INSTALLATION, OPERATING, AND MAINTENANCE INSTRUCTIONS BEFORE INSTALLING OR SERVICING THIS EQUIPMENT.

ELECTRICAL GROUNDING INSTRUCTIONS

THIS APPLIANCE, WHEN INSTALLED, MUST BE ELECTRICALLY GROUNDED IN ACCORDANCE WITH LOCAL CODES, OR IN THE ABSENCE OF LOCAL CODES, WITH THE NATIONAL ELECTRICAL CODE, ANSI/NFPA 70, OR THE CANADIAN ELECTRICAL CODE, CSA C22.2 AS APPLICABLE.

THIS APPLIANCE IS EQUIPPED WITH A THREE PRONG (GROUNDING) PLUG FOR YOUR PROTECTION AGAINST SHOCK HAZARD AND SHOULD BE PLUGGED DIRECTLY INTO A PROPERLY GROUNDED THREE-PRONG RECEPTACLE. DO NOT CUT OR REMOVE THE GROUNDING PRONG FROM THIS PLUG.

KEEP THE OVEN AREA FREE AND CLEAR FROM COMBUSTIBLE AND NONCOMBUSTIBLE CONSTRUCTION. DO NOT OBSTRUCT THE FLOW OF COMBUSTION AND VENTILATION AIR.

AN ELECTRICAL DIAGRAM IS LOCATED ON THE INSIDE OF THE CONTROL DOOR ON ALL MB SERIES OVENS.

THIS OVEN HAS ZERO CLEARANCE ON BOTH SIDES TO COMBUSTIBLE AND NON-COMBUSTIBLE CONSTRUCTION BUT A 3" - 4" SPACE MUST BE LEFT AT THE REAR TO ALLOW ADEQUATE CLEARANCE FOR AIR OPENINGS INTO THE COMBUSTION CHAMBER INSURING PROPER CIRCULATION OF AIR INTO THE BURNER SYSTEM.

THIS MANUAL MUST BE RETAINED FOR FUTURE REFERENCE.



The Marsal Pizza Ovens logo, with 'MARSAL' in large, bold, orange letters and 'PIZZA OVENS' in smaller, bold, black letters below it.



TABLE OF CONTENTS

I INSTALLATION

SERVICE ACCESS	3
ELECTRICAL CONNECTION	3
GAS CONNECTION.....	3
GAS AND ELECTRICAL SPECIFICATIONS.....	4
DELIVERY	4
OVEN LOCATION.....	4
ADJUSTMENTS ASSOCIATED WITH INITIAL INSTALLATION.....	5
ASSEMBLY INSTRUCTIONS.....	6
VENTILATION.....	7
INSTALLING THE COOKING STONES	9
INSTALLING THE CEILING BRICKS	12
CURING THE OVEN DECK	13

II OPERATION

STARTING THE OVEN.....	14
OVEN CONTROL	14
CLEANING THE OVEN	15

III ADDITIONAL INSTRUCTIONS - WF MODELS ONLY..... 16

INSTALLATION

Installation must conform with local codes, or in the absence of local codes, with the National Fuel Gas Code, ANSI Z223.1, Natural Gas Installation Codes, CAN/CGA-B149.1, or the Propane Installation Code, CAN/CGAB149.2, as applicable.

1. The appliance and its individual shutoff valve must be disconnected from the gas supply piping system at test pressures in excess of ½ psig (3.45kPa).
2. The appliance must be isolated from the gas supply piping system by closing its individual manual shut-off valve during any pressure testing of the supply system at test pressures in excess of ½ psig (3.45kPa).

SERVICE ACCESS

All service can be done through the Control Door opening and the Burner Door opening. An access panel is located on the left side of the oven for more access to the controls. If this is blocked off all service can be one from the front of the oven.

ELECTRICAL CONNECTION

A 15 AMP service must be provided for MB Series and WF Series ovens. For 115 Volt usage, a cord and plug is provided but connection to the electrical service must comply with local codes; or in the absence of local codes, with the National Electrical Code, ANSI/NFPA No. 70 (or latest edition)

GAS CONNECTION

A ¾" NPT inlet is located at the rear of the oven. Undersized gas supply lines will restrict gas supply and affect oven performance. If other appliances are supplied by the same supply line the supply line must be sized to carry the combined volume without causing more than ½" pressure drop at the manifold of each appliance on the line at full rate. When installing a stacked oven with one line, the line should be 1" to the tee and the ¾" into each oven.

NOTE: During installation, there will be air in the line. The air must be bled off before ignition can be established.

GAS PIPING

A properly sized gas supply system is essential for maximum oven performance. Piping should be sized to provide a supply of gas sufficient to meet the maximum demand of all appliances on the line without loss of pressure at the equipment.

GAS HOSE RESTRAINT

If the oven is mounted on casters, a commercial flexible connector with a minimum of ¾" (1.9 cm) inside diameter must be used along with a quick connect device.

The restraint, supplied with the Flexible Hose Kit, must be used to limit the movement of the unit so that no strain is placed upon the flexible connector. With the restraint fully stretched the connector should be easy to install and quick connect.

1. Mount the supplied bracket to the angle iron welded across the back of the stand.

The connector must comply with the Standard Connectors for Movable Gas Appliances, ANSI Z21.59 or Con-

nectors for Moveable Gas Appliances CAN/CHA-6.16 and a quick disconnect device that complies with the Standard for Quick Disconnect Devices for Use With Gas Fuel, ANSI Z.41 or Quick Disconnect For Use With Gas Fuel CAN 1-6.9. Adequate means must be provided to limit the movement of the appliance without depending on the connection and the quick disconnect device or its associated piping.

GAS AND ELECTRICAL SPECIFICATIONS

MODELS	INPUT RATE		MANIFOLD PRESSURE		ELECTRICAL REQUIREMENTS
	Natural Gas	Propane	Natural Gas	Propane	MB and WF ovens only
MB42, SD448, SD1048	95,000	90,000	4.5 IN. WC	11 IN. WC	Volts 120VAC Frequency 60Hz 0.9 AMPS Phase 1
MB60, SD660, SD1060	130,000	125,000	4.5 IN. WC	11 IN. WC	
SD236, MB236	50,000	50,000	3.5 IN. WC	10 IN. WC	
SD248	65,000	65,000	4.5 IN. WC	11 IN. WC	
SD260, MB260	80,000	80,000	4.5 IN. WC	11 IN. WC	
MB866, SD866, SD10866	130,000	125,000	4.5 IN. WC	11 IN. WC	
WF42	135,000	135,000	4.5 Main 3.5 Side	11 Main 10 Side	
WF60	155,000	155,000	4.5 Main 3.5 Side	11 Main 10 Side	

WARNING!!

Our natural gas runs on a ½ lb. system. Any higher pressure must be reduced to ½ lb. prior to the oven.

DELIVERY

Marsal cannot assume responsibility for loss or damage suffered in transit. The carrier assumed full responsibility for delivery in good order when the shipment was accepted. We are, however, prepared to assist you if filing a claim is necessary.

OVEN LOCATION

The oven should be installed in a location in which the facilities for ventilation permit satisfactory combustion of gas and proper venting. The oven should be located so as not to interfere with proper circulation of air within the confined space. In buildings where normal infiltration does not provide the necessary air, outside air “make up” should be introduced.

It is essential that an adequate air supply to the oven be maintained to provide a sufficient flow of combustion and ventilation air.

- Place the oven in an area that is free of drafts.

- Do not place the oven on a curb base or seal to a wall. This will restrict the flow of air and prevent proper ventilation. Pilot outages or yellow, floating flames on the main burners are indicative of a lack of secondary air.

Before making any utility connections to this oven, check the rating plate to be sure the oven specifications are compatible with the gas and electrical services supplied for the oven. The rating plate is located on the inside wall of the control door area.

ADJUSTMENTS ASSOCIATED WITH INITIAL INSTALLATION

Each oven, and its component parts, have been thoroughly tested and inspected prior to shipment. However, it is often necessary to further test or adjust the oven as part of a normal and proper installation. These adjustments are the responsibility of the installer, or dealer. Since these adjustments are not considered defects in material or workmanship, they are not covered by the Original Equipment Warranty. They include, but are not limited to:

- calibration of the thermostat
- adjustment of the doors
- burner adjustments
- leveling
- testing of gas pressure
- tightening of fasteners



WARNING!!

No installation should be considered complete without proper inspection, and if necessary, adjustment by qualified installation or service personnel.

ASSEMBLY INSTRUCTIONS

For all oven models:

1. Place the oven base in the final location.
2. Level the base from left to right and front to back by adjusting the legs in each corner.
3. Place the oven body on top of the oven base making sure that the front and the front corners are even between the base and the body. ****With stack units, the oven that was shipped with the base is the bottom oven.**
4. Install the two 1/4 x 20 x 1" bolts through the front of the base into the front of the body from underneath the base. Next, align the back corners of the body and the base together and install the other two 1/4 x 20 x 1" bolts through the back of the base and the back of the body.
5. For stackable units, place the top oven on the bottom oven and align their front and sides. The weight of the unit will keep it in place.
6. Connect a gas line to the back of each oven and follow all local gas codes in connecting to the gas supply.
7. Plug in the electric plug for the light to an electric power supply. (For MB Ovens Only) On the WF Ovens the power supply is for the electronic ignition of the side burner.
8. Connect the exhaust system to the flue of the oven.

NOTE: FOLLOW ALL LOCAL FIRE AND SAFETY CODES FOR VENTING AN OVEN. IF THE OVEN IS BEING INSTALLED UNDER A CANOPY HOOD, THE 6" X 14" STAINLESS STEEL FLUE VENT MUST BE INSTALLED. A HOOD IS ALWAYS RECOMMENDED EVEN WHEN DIRECT VENTED.

9. The base should be sealed to the floor using a NSF approved sealant.
10. On the WF Ovens, the stainless steel shelf is installed AFTER the cooking surface is installed and cured.

VENTILATION

Local codes and conditions vary greatly from one area to another and must be complied with. The following are the minimum requirements for good ventilation. Please remember that these are general recommendations or guidelines and you may have a special condition or problem that will require the services of a ventilation engineer or specialist.

PROPER VENTILATION IS THE OVEN OWNER'S RESPONSIBILITY. Improper ventilation will inhibit oven performance, such as the pilot going out or the burning of the bottom of pies. Marsal cannot assume responsibility for loss or damage suffered as a result of improper installation.

This oven may be vented using either:

- A mechanically driven, canopy type, exhaust hood, or
- A direct flue arrangement

CANOPY METHOD

(When the exhaust from the oven dumps into the canopy hood)

The SHORT STAINLESS STEEL FLUE that is supplied with the oven MUST BE INSTALLED. Place the flue over the collar that is located on the top of the oven and press down until it is firmly locked in place. The angle should face forward and always away from any filters. A strong exhaust fan will create a vacuum in the room. For an exhaust system to work properly, replacement air must be introduced into the room. In the case of a filtered hood, the hood must be designed not to pull exhaust out of the oven.

The hood should be sized to completely cover the equipment plus an overhang of at least 6" (15 cm) on all sides not adjacent to a wall and 10"-12" (25.4 - 30.4 cm) in front of the oven. The distance from the floor to the lower edge of the hood should not exceed 7' (2.1 m). THE RECOMMENDED CFM FOR THE HOOD IS APPROXIMATELY 150CFM PER LINEAR FOOT

The capacity of the hood should be sized appropriately with provisions for an adequate supply of make-up air.

DIRECT CONNECTION METHOD

(When the exhaust from the oven is directly vented to the outside)

An unrestricted vent pipe that provides exit air at the oven of a minimum of 55 CFM per oven must be provided for the vent pipe at the top of the oven. The vent pipe should be a minimum of 6" in diameter. A DRAFT DIVERTER (or draft hood) MUST BE INSTALLED for a direct vent connection system in order to work properly. No more than two 90° elbows should ever be used in a direct vent connection and all horizontal runs must have at least a 1" per foot pitch.



WARNING!!

It is essential that the direct flue be installed as follows. Incorrect installation will result in unsatisfactory baking, oven damage, and pilot outages.

The flue must be class B or better. The height of the flue should rise 6-8 ft (2-2.5 m) above the roof of the building or any proximate structure. The flue should be capped with a UL Listed type vent cap to isolate the unit from external environmental conditions.

The direct vent cannot replace air consumed and vented by the oven. Provisions must be made to supply the room with sufficient make-up air. Total make-up air requirements for each oven section should be approximately 30 CFM per section. To increase the supply air entering the room, a ventilation expert should be consulted.

WARNING!!

Failure to properly vent the oven can be hazardous to the health of the operator and may result in operational problems, unsatisfactory baking and possible damage to the equipment.

Damage sustained as a direct result of improper ventilation will not be covered by the Manufacturer's warranty.

INSTALLING THE DRAFT DIVERTER

Ovens ordered for direct venting are supplied with a draft hood. Install the draft hood as follows:

1. Place the draft diverter over the flue connector.
2. Install the rest of the venting system to the draft hood (draft diverter).

FAILURE TO INSTALL A DRAFT DIVERTER WHEN USING A DIRECT CONNECTION METHOD WILL CAUSE PILOT OUTAGES AND IMPROPER BAKING. SERVICE CALLS THAT ARE MADE BECAUSE THE PROBLEM IS THE ABSENCE OF AN INSTALLED DRAFT DIVERTER ARE NOT COVERED UNDER WARRANTY AND ALL COSTS WILL BE THE RESPONSIBILITY OF THE OWNER.

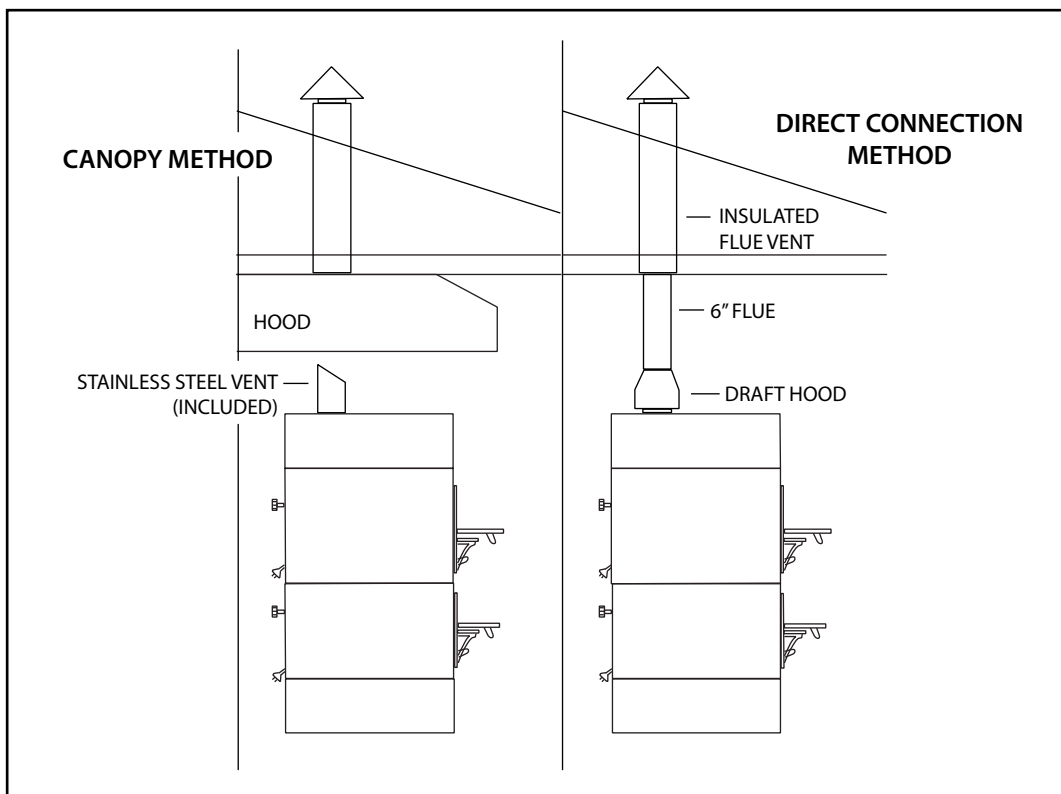

Figure 1

VENTING PROBLEMS

If the venting of any deck oven is either restricted or forced in any way the baking characteristics of the oven will be adversely affected.

Examples of restricted venting include:

- Use of tees and too many elbows
- Long horizontal runs without the proper pitch of 1" per foot

Insufficient make-up air can cause heated air and combustibles to remain in the oven shortening the life of the components.

INSTALLING THE COOKING STONES

The following instructions are model specific.

1. Start by installing the cooking stones used for the baking deck. These cooking stones are 2" thick and must be installed ROUGH SIDE UP. Push cooking stones together to eliminate any space.

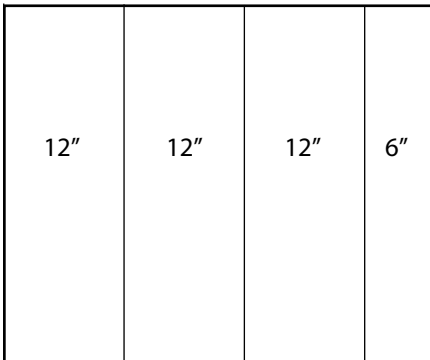
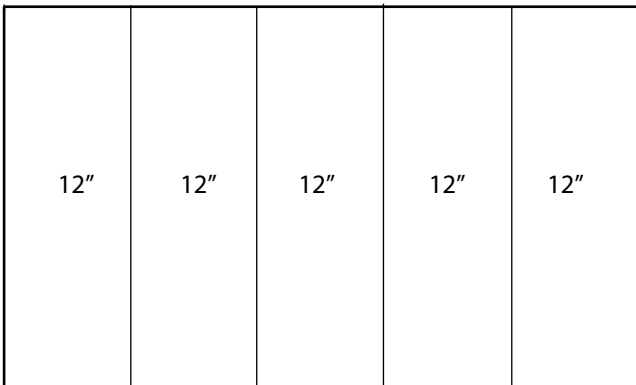
<p>MB42</p> <p>Place the (3) 12" x 36" cooking stones and the (1) 6" x 36" cooking stones on the sheet metal of the oven deck. The 6" x 36" cooking stones must be placed on the right side of the deck oven as shown.</p>	 <p style="text-align: center;">FRONT OF OVEN</p>
<p>MB60, SD 660, SD 1060</p> <p>Place the (5) 12" x 36" cooking stones on the sheet metal of the oven deck as shown.</p>	 <p style="text-align: center;">FRONT OF OVEN</p>

MB 866, SD 866, SD 1086

Place the (5) 13" x 44" cooking stones on the sheet metal of the oven deck as shown.

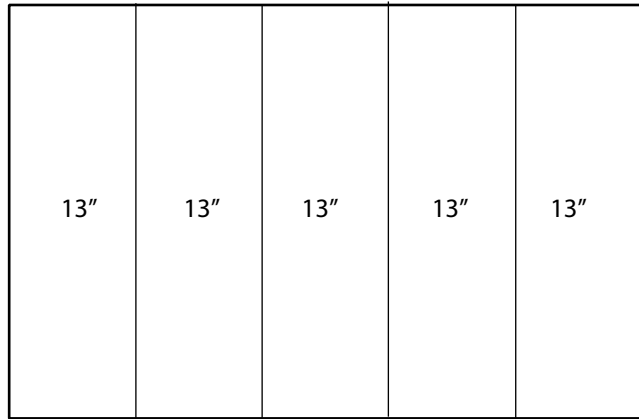

FRONT OF OVEN

SD 448, SD1048

Place the (4) 12" x 36" cooking stones on the sheet metal of the oven deck as shown.

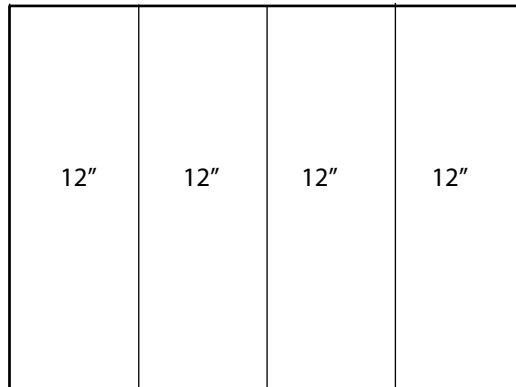

FRONT OF OVEN

SD 236, MB 236

Place the (3) 12" x 24" cooking stones on the sheet metal of the oven deck as shown.

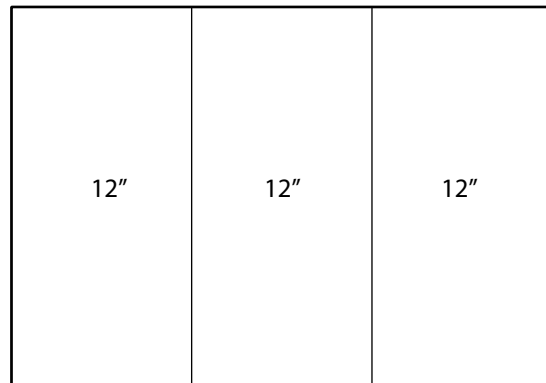

FRONT OF OVEN

SD 248

Place the (4) 12" x 24" cooking stones on the sheet metal of the oven deck as shown.

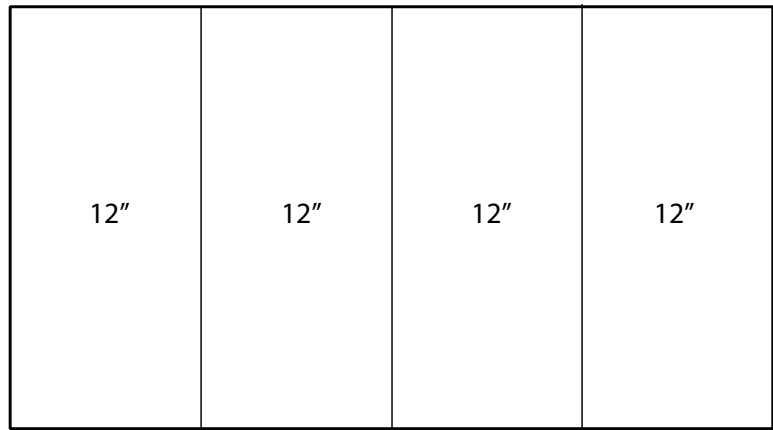

FRONT OF OVEN

SD 260

Place the (5) 12" x 24" cooking stones on the sheet metal of the oven deck as shown.

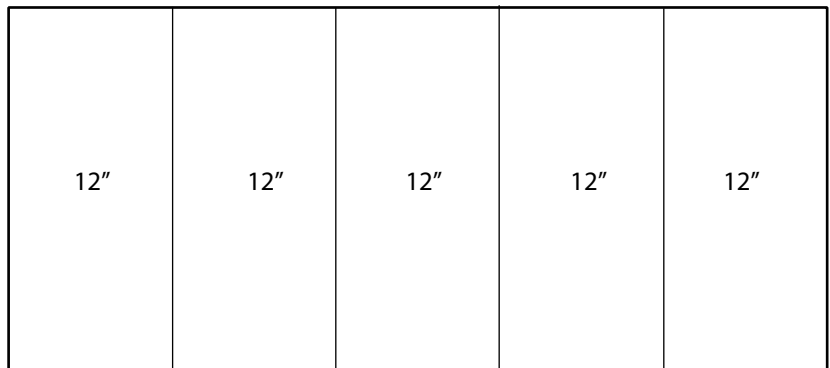

FRONT OF OVEN

WF42

Place the (3) 12" x 36" cooking stones on the sheet metal of the oven deck as shown.

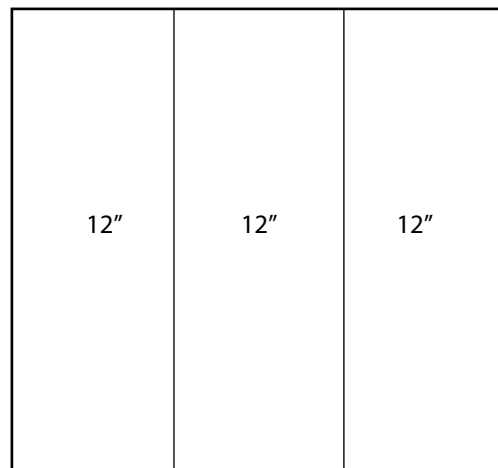

FRONT OF OVEN

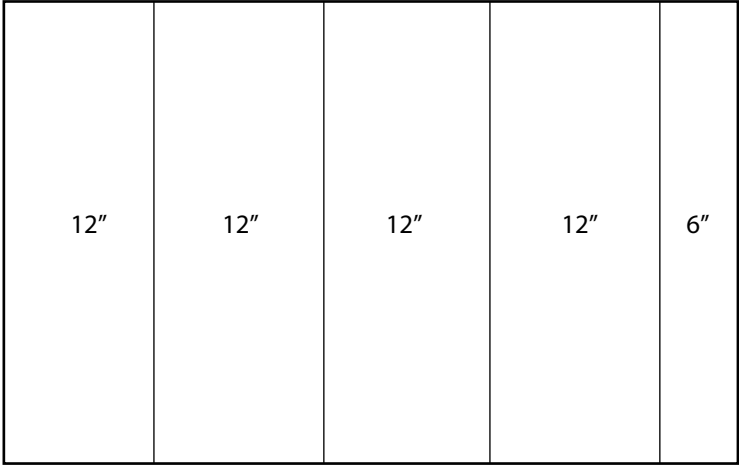
<p>WF60</p> <p>Place the (4) 12" x 36" cooking stones toward the left on the sheet metal of the oven deck and the (1) 6" x 36" cooking stones must be toward the right on the sheet metal of the oven deck as shown.</p>	 <p style="text-align: center;">FRONT OF OVEN</p>
---	---

2. Install the supplied crumb-catcher by pushing toward the back all the cooking stones. Place the crumb-catcher between the cooking stones and the baking door opening.

INSTALLING THE CEILING BRICKS

MB SERIES, WF SERIES, SD BRICK-LINED OVENS ONLY

1. Install the brick in the dome as follows:

MB 42, WF42

1. Slide (5) 9 1/2" x 6" bricks on each of the 10" brick support tracks in side the top of the oven.
2. Slide (5) 12" x 6" bricks on each of the 12 1/2" tracks.

MB 60, WF60

1. Slide (5) 12" x 6" bricks on each of the brick support tracks.

MB 866

1. Slide (4) 2" x 12" bricks first in the 12 1/2" tracks (1) per track
2. Slide (2) 2" x 8 1/2" bricks first in the 9" tracks (1) per track
3. Slide (6) 12" x 6" bricks on each of the 12 1/2" tracks.
4. Slide (6) 12" x 8 1/2" bricks on the 9" tracks located in the middle of the chamber

SD 236

1. Slide (4) 4.5" x 9" bricks into 2 rows, then (5) 4.5" x 7" bricks into 2 rows.

SD 248

1. Slide (4) 4.5" x 9" bricks into 5 rows

SD 260

1. Slide (4) 4.5" x 9" bricks into 6 rows

SD 448/1048

1. Slide (7) 4.5" x 9" bricks into 5 rows

SD 660/1060

1. Slide (7) 4.5" x 9" bricks into 6 rows

SD886/10866

1. Slide (8) 4.5" x 9" bricks into 6 rows

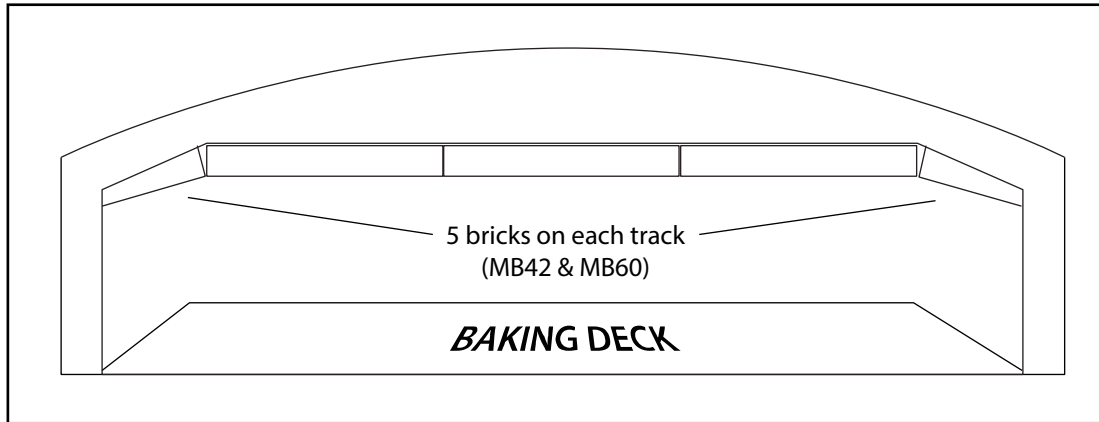

Figure 2

CURING THE OVEN DECK

1. Sweep off all the debris from the brick deck surface.
2. Set the oven temperature to 150°F (66°C).
3. Run the oven for one hour.
4. Set the oven to 250°F (121°C).
5. Run for one hour.
6. Set the oven to 350°F (177°C).
7. Run the oven for one hour.
8. Set the oven to 450°F (232°C).
9. Run the oven for one hour.
10. Oven stones are now cured.

NOTE: WHEN LIGHTING THE OVEN FOR THE FIRST TIME, AS THE TEMPERATURE INCREASES, SMOKE WILL OCCUR FROM THE OVEN. BE SURE TO LEAVE THE DOORS CLOSED, VENT OPEN, AND TO HAVE THE EXHAUST FAN ON THE HOOD TURNED TO ON.

OPERATION

STARTING THE OVEN

1. Purge all air out of the gas line. (Initial startup)
2. Open the control door and open the burner door at the bottom of the oven.
3. Hold the red button in and manually light the pilot (this is seen through the opening on the left, inside the burner area).
4. Hold the red button in until the probe in front of the pilot gets hot. (approximately 30 seconds) Then release the red button. Pilot should stay lit - if not, try again.
5. Adjust the oven temperature to the desired amount (usually between 500°-600° F for pizza). The main burners will turn on.
6. Close the control and burner doors.

NOTE: The oven's cooking surface is for pizza and bread only. All other products must be placed in pans.

- A bypass has been set from the factory.
- Adjustments to the bypass on the thermostat follow the instructions in the service manual.
- Check calibration and adjust if necessary by following the service manual.

SETTING THE BYPASS AND CALIBRATIONS AND OTHER ADJUSTMENTS ARE NOT COVERED UNDER WARRANTY AND ARE THE RESPONSIBILITY OF THE OWNER OR THE DEALER WHO SOLD OR INSTALLED THE APPLIANCE.

If the oven is supplied on casters and is connected to the supply piping by means of a connector for movable appliances, be aware that a restraint must be on the appliance and, if disconnection of the restraint is necessary, you must reconnect this restraint after the appliance has been returned to its originally installed position.

OVEN CONTROL

PREHEATING OVEN

On initial startup, preheat the oven to 600° F (315° C) over a period of five hour increments starting with just the pilot for 1 hour and then increments of 100° F (55° C) starting at 300° F (149° C).

TURNING OVEN OFF

You can shut the main burners off and leave the pilot on by turning the red valve, located between the safety pilot valve and the thermostat, clockwise to the 3 o'clock position.

- Extinguish the pilot flame by blowing out the pilot flame.
- A 5 MINUTE complete shutoff period is necessary before the oven can be relighted.
- Shut off side burner by turning the toggle switch to OFF position (WF only)

CLEANING THE OVEN

OVEN EXTERIOR

The stainless steel surface should be cleaned when cool using a mild soap and warm water solution on a sponge or a clean cloth. On WF Ovens, clean the glass only when the oven is cool.

OVEN INTERIOR

The inside metal surfaces should be cleaned with a mild detergent and a damp cloth when necessary. The cooking surface should be scraped/brushed clean and then a wet cloth draped over the brush should be run over the surface while the oven is still hot.

NOTE: The burner venturi must be checked and kept clean. The area around the air shutter must stay about 1/8" - 3/16" open and free of any dust.

CLEANERS

On the stainless steel front the deposits of baked splatter may be removed with any nontoxic industrial stainless steel cleaner. Heat tint and heavy discoloration may be removed with any non-toxic commercial oven cleaner.

1. Apply cleaners when the oven is cold, and always rub with the grain of the metal.

Clean the aluminized interior portion of the oven with a mild detergent if necessary. DO NOT use caustic solutions such as ammonia, lye or soda ash. DO NOT use domestic oven cleaners. Any of these products will damage the aluminum coating and any stainless steel finish.

DAILY CLEANING

- Clean brick surfaces using a deck scraper and brush. A wet towel draped over the brush should be run over the brick surface while the baking chamber is still hot.

WEEKLY CLEANING

- Brush out the combustion compartment behind the burner door.

6 MONTH CLEANING

- Clean secondary air ducts and air entry ports located on the back of each oven.
- Clean the area around the air shutter so that it stays 1/8" – 3/16" open and free of dust.



CAUTION!!

DISCONNECT THE POWER SUPPLY ON MB & WF OVENS BEFORE CLEANING OR SERVICING.

If maintenance or repairs are required, contact the factory, the factory representative or a local Marsal service company found on our website <http://www.marsalsons.com>

ADDITIONAL INSTRUCTIONS - WF MODELS ONLY

OPERATION

- To turn on the side burner, you must first flip the toggle switch (located in the control compartment) up to the ON position. This will turn on the electronic ignition and light the pilot
- Align the red handle valve located on the right side of the control compartment with the gas line. This will put the side burner at full flame.
- Start with the thermostat set at "5" and the side burner flame on FULL.
- To shut off the side burner just flip the toggle switch down to the OFF position.

CONTROLLING TOP AND BOTTOM HEAT

- To get the most top heat, the side burner should be on FULL. You can decrease the amount of top heat by partially closing the valve for the side burner.
- Adjust the bottom heat - and overall heat - by raising or lowering the thermostat knob.
- Use the thermometer on the right side of the oven to determine the top heat on the flame side of the baking chamber.

**** The heat on the right side of the oven is approximately 100°F higher than on the left side. Any part of the product being cooked that is facing the flames will cook faster and therefore the products must be spun and watched carefully.*

INSTALLATION OF S/S FRONT SHELF AND FRONT HOOD

- Install the front stainless steel shelf after the cooking surface is installed and cured. Use the four tec screws provided to secure the shelf to the body of the oven (Note: the shelf will close the gap between the cooking surface and the front of the baking chamber.
- If the hood in the front has been removed then reattach by sliding the hood over and down the screws located in the front of the oven alongside the flue.

INSTALLING FAÇADE

- When tiling or bricking the front of the WF Series Oven, DO NOT COVER THE FRONT WINDOW, WINDOW FRAME AND WINDOW FRAME VENTS. DO NOT TILE BEHIND THE FRONT WINDOW.
- TILE OR BRICK MUST NOT INTERFERE WITH THE REMOVAL OF THE FRONT WINDOW, THERMOMETERS, SHELF, OR FRONT FLUE.