



TRUE MANUFACTURING CO., INC.
U.S.A. FOODSERVICE DIVISION

2001 East Terra Lane • O'Fallon, Missouri 63366-4434 • (636)240-2400
Fax (636)272-2408 • Toll Free (800)325-6152 • Intl Fax# (001)636-272-7546
Parts Dept. (800)424-TRUE • Parts Dept. Fax# (636)272-9471 • www.truemfg.com

Project Name: _____

Location: _____

Item #: _____ Qty: _____

Model #: _____

A/A #

S/S #

Model:

G4SM-23FC-HC~TSL01

Glass Four Sided Floral Case Merchandiser:

Swing Door Refrigerator with Hydrocarbon Refrigerant~True Standard Look Version 01



Shown with optional Copper Exterior.

G4SM-23FC-HC~TSL01

- ▶ The world's #1 manufacturer of glass door merchandisers.
- ▶ Factory engineered, self-contained, capillary tube system using environmentally friendly R290 hydro carbon refrigerant that has zero (0) ozone depletion potential (ODP), & three (3) global warming potential (GWP).
- ▶ High capacity, factory balanced refrigeration system. Designed to accommodate a broad range of floral temperature settings, holds 35°F (1.6°C).
- ▶ Exterior - non-peel or chip black laminated vinyl; durable and permanent.
- ▶ Interior - attractive, black aluminum interior liner with stainless steel floor.
- ▶ Self closing door. Positive seal, torsion type closure system.
- ▶ "Low-E"; double pane thermal insulated glass in door assembly, sides and rear. The latest in energy efficient technology.
- ▶ LED interior lighting provides more even lighting throughout the cabinet. Safety shielded.
- ▶ Illuminated exterior front sign panel.
- ▶ Entire cabinet structure is foamed-in-place using a high density, polyurethane insulation that has zero ozone depletion potential (ODP) and zero global warming potential (GWP).

Bottom mounted units feature

- ▶ "No stoop" lower shelf to maximize product visibility.
- ▶ Storage on top of cabinet.
- ▶ Easily accessible condenser coil for cleaning.

ROUGH-IN DATA

Specifications subject to change without notice.
Chart dimensions rounded up to the nearest 1/8" (millimeters rounded up to next whole number).

Model	Doors	Shelves	Cabinet Dimensions (inches) (mm)			HP	Voltage	Amps	NEMA Config.	Cord Length (total ft.) (total m)	Crated Weight (lbs.) (kg)
			L	D†	H						
G4SM-23FC-HC~TSL01	1	2	27½ 699	30⅞ 766	78⅞ 1998	⅓ N/A	115/60/1	5.4 N/A	5-15P	9 2.74	375 171

† Depth does not include 1 1/8" (42 mm) for door handle.



APPROVALS:

AVAILABLE AT:

5/21

Printed in U.S.A.

Model:
G4SM-23FC-HC-TSL01

Glass Four Sided Floral Case Merchandiser:
Swing Door Refrigerator with Hydrocarbon Refrigerant~True Standard Look Version 01



STANDARD FEATURES

DESIGN

- True's commitment to using the highest quality materials and oversized refrigeration systems provides the user with better product temperatures, and lower utility costs in a stylish merchandiser that brilliantly displays high profit floral arrangements in a dynamic 360° display.
- True's floral merchandisers offer baffled airflow design which creates ideal environment to prolong fresh flower shelf life.
- Black exterior with product accentuating black shelves further entice customers to purchase high profit floral arrangements.

REFRIGERATION SYSTEM

- Factory engineered, self-contained, capillary tube system using environmentally friendly R290 hydrocarbon refrigerant that has zero (0) ozone depletion potential (ODP), & three (3) global warming potential (GWP).
- High capacity, factory balanced refrigeration system that maintains cabinet temperatures of holds 35°F (1.6°C). Designed to accommodate a broad range of floral temperature settings.
- State of the art, electronically commutated evaporator and condenser fan motors. ECM motors operate at higher peak efficiencies and move a more consistent volume of air which produces less heat, reduces energy consumption and provides greater motor reliability.
- Bottom mounted condensing unit positioned for easy maintenance; "no stoop" lower shelf maximizes visibility by raising merchandised product to higher level.

CABINET CONSTRUCTION

- Exterior - non-peel or chip black powder coated cold rolled steel; durable and permanent.
- Low-E, double pane thermal insulated glass sides and door assembly. The latest in energy efficient technology.
- Interior - attractive, black aluminum interior liner with stainless steel floor.
- Insulation - entire cabinet structure is foamed-in-place using a high density, polyurethane insulation that has zero ozone depletion potential (ODP) and zero global warming potential (GWP).
- Welded, heavy duty steel frame rail, black powder coated for corrosion protection.
- Frame rail fitted with leg levelers.
- Illuminated exterior front sign panel. Variety of sign options available.

DOOR

- "Low-E", double pane thermal insulated glass door assembly with extruded aluminum frame. The latest in energy efficient technology.
- Door fitted with 12" (305 mm) long extruded handle.
- Self closing door. Positive seal, torsion type closure system.
- Magnetic door gasket of one piece construction, removable without tools for ease of cleaning.

SHELVING

- Two (2) adjustable, heavy duty, black PVC coated wire shelves 23 5/8" L x 20 7/8" D (601 mm x 631 mm). Four (4) chrome plated shelf clips included per shelf.

- Shelf support pilasters made of same material as cabinet interior; shelves are adjustable on 1/2" (13 mm) increments.

LIGHTING

- LED interior lighting provides more even lighting throughout the cabinet. Safety shielded.

MODEL FEATURES

- Evaporator is epoxy coated to eliminate the potential of corrosion.

ELECTRICAL

- Unit completely pre-wired at factory and ready for final connection to a 115/60/1 phase, 15 amp dedicated outlet. Cord and plug set included.



115/60/1
NEMA-5-15R

OPTIONAL FEATURES/ACCESSORIES

Upcharge and lead times may apply.

- Copper exterior.
- White exterior.
- 6" (153 mm) standard legs.
- 6" (153 mm) seismic/flanged legs.
- 2 1/2" (64 mm) diameter castors.
- 4" (102 mm) diameter castors.
- Red wine thermostat.
- Chocolate thermostat.
- White wine thermostat.
- Barrel Locks - located in grill assembly (requires one per door)

PLAN VIEW

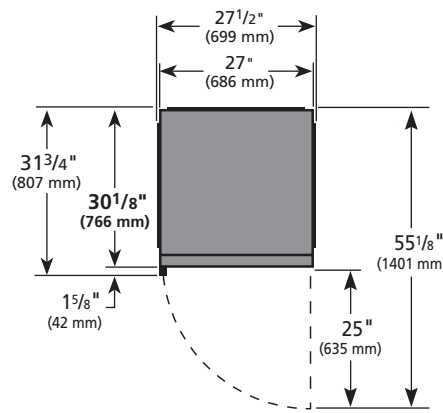
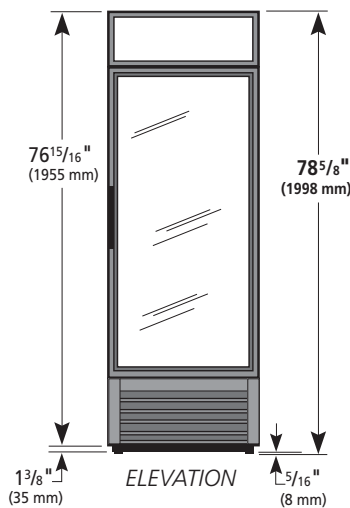

3 YEAR PARTS + LABOR **7 YEAR COMPRESSOR**
WARRANTY
(U.S.A. and Canada only)

METRIC DIMENSIONS ROUNDED UP TO THE NEAREST WHOLE MILLIMETER
SPECIFICATIONS SUBJECT TO CHANGE WITHOUT NOTICE



Model	Elevation	Right	Plan	3D	Back
G4SM-23FC-HC-TSL01					

TRUE MANUFACTURING CO., INC.