



LuminIce[®] Growth Inhibitor

Ice Machine Accessory

Installation, Operation and Maintenance Manual



Original Document

 **Caution**

Read this instruction before operating this equipment.

Safety Notices

Safety Notices

Read these precautions to prevent personal injury:

- Read this manual thoroughly before operating, installing or performing maintenance on the equipment. Failure to follow instructions in this manual can cause property damage, injury or death.
- Routine adjustments and maintenance procedures outlined in this manual are not covered by the warranty.
- Proper installation, care and maintenance are essential for maximum performance and trouble-free operation of your equipment. Visit our website www.manitowocice.com for manual updates, translations, or contact information for service agents in your area.
- This equipment contains high voltage electricity and refrigerant charge. Installation and repairs are to be performed by properly trained technicians aware of the dangers of dealing with high voltage electricity and refrigerant under pressure. The technician must also be certified in proper refrigerant handling and servicing procedures. All lockout and tag out procedures must be followed when working on this equipment.
- Read this manual thoroughly before operating, installing or performing maintenance on the equipment. Failure to follow instructions in this manual can cause property damage, injury or death.

DEFINITIONS

⚠ DANGER

Indicates a hazardous situation that, if not avoided, will result in death or serious injury. This applies to the most extreme situations.

⚠ Warning

Indicates a hazardous situation that, if not avoided, could result in death or serious injury.

⚠ Caution

Indicates a hazardous situation that, if not avoided, could result in minor or moderate injury.

Notice

Indicates information considered important, but not hazard-related (e.g. messages relating to property damage).

NOTE: Indicates useful, extra information about the procedure you are performing.

⚠ DANGER

Do not operate equipment that has been misused, abused, neglected, damaged, or altered/modified from that of original manufactured specifications. This appliance is not intended for use by persons (including children) with reduced physical, sensory or mental capabilities, or lack of experience and knowledge, unless they have been given supervision concerning use of the appliance by a person responsible for their safety. Do not allow children to play with, clean or maintain this appliance without proper supervision.

⚠ DANGER

Follow these precautions to prevent personal injury during use and maintenance of this equipment:

- It is the responsibility of the equipment owner to perform a Personal Protective Equipment Hazard Assessment to ensure adequate protection during maintenance procedures.
- Do Not Store Or Use Gasoline Or Other Flammable Vapors Or Liquids In The Vicinity Of This Or Any Other Appliance. Never use flammable oil soaked cloths or combustible cleaning solutions for cleaning.
- All covers and access panels must be in place and properly secured when operating this equipment.
- Risk of fire/shock. All minimum clearances must be maintained. Do not obstruct vents or openings.
- Failure to disconnect power at the main power supply disconnect could result in serious injury or death. The power switch DOES NOT disconnect all incoming power.
- All utility connections and fixtures must be maintained in accordance with the authority having jurisdiction.
- Turn off and lockout all utilities (gas, electric, water) according to approved practices during maintenance or servicing.
- Units with two power cords must be plugged into individual branch circuits. During movement, cleaning or repair it is necessary to unplug both power cords.
- Never use a high-pressure water jet for cleaning on the interior or exterior of this unit. Do not use power cleaning equipment, steel wool, scrapers or wire brushes on stainless steel or painted surfaces.
- Two or more people are required to move this equipment to prevent tipping.
- Locking the front casters after moving is the owner's and operator's responsibility. When casters are installed, the mass of this unit will allow it to move uncontrolled on an inclined surface. These units must be tethered/secured to comply with all applicable codes.
- The on-site supervisor is responsible for ensuring that operators are made aware of the inherent dangers of operating this equipment.
- Do not operate any appliance with a damaged cord or plug. All repairs must be performed by a qualified service company.
- Crush/Pinch Hazard. Keep hands clear of moving components. Components can move without warning unless power is disconnected and all potential energy is removed.

Table of Contents

Safety Notices

Safety Notices	3
Definitions	3

Section 1

General Information

Compatible Ice Machine Models	7
Indigo® NXT Models.....	7
Indigo® Models	7
NEO® Undercounter Models.....	7
LuminIce®	7
LuminIce® Kits	8
LuminIce® Replacement Bulbs	8
Before You Begin Installation	8

Section 2

Installation

Indigo® NXT or Indigo® Model 22" & 30" Wide Single Evaporator Installation	9
K00464 & K00465 Indigo® NXT Models Low voltage wire installation	10
K00424, K00434, K00440, K00450, K00451, K00452 Indigo® Model Power supply installation procedure	11
Indigo® NXT or Indigo® Model 48" Wide Single Evaporator Installation K00451 Indigo® & K00465 Indigo® NXT	12
K00465 Indigo® NXT Models Low voltage wire installation ..	14
K00424, K00434, K00440, K00450, K00451, K00452 Indigo® Model Power supply installation procedure	14
Indigo® NXT or Indigo® Two-Evaporator Ice Machine Model Installation K00434, K00451 Indigo® & K00465 Indigo® NXT	15
K00465 Indigo® NXT Models Low voltage wire installation ..	17
K00434, K00451 Indigo® Model Power supply installation procedure	17
NEO® Undercounter Model Installation	18
Ice Beverage (IB) Single Evaporator Model Installation	20

Table of Contents (continued)

Section 3 Maintenance

Replacement Bulb Usage	23
LuminIce® II Indicator Lights	23
Bulb Replacement Frequency	23
LuminIce® Reminder Setup for Indigo® NXT & Indigo®	
Model Ice Machines	23
Indigo® Touchscreen Models	23
Indigo® Models without touchscreen.....	23
Bulb Replacement	24
Cleanup Procedure for Accidental Bulb Breakage.....	25
Before Cleanup	26
During Cleanup	26
After Cleanup.....	26
Cleanup Steps for Hard Surfaces	26
Cleanup Steps for Carpeting or Rugs	27
Future Cleaning of Carpeting or Rugs	28

Section 1

General Information

Compatible Ice Machine Models

This manual covers installation of LuminIce® II models on the ice machines listed below.

INDIGO® NXT MODELS

- Self-contained air-cooled models
- Self-contained water-cooled models
- Remote condenser air-cooled models
- QuietQube remote condensing unit models
- Ice Beverage remote condensing unit models

INDIGO® MODELS

- Self-contained air-cooled models
- Self-contained water-cooled models
- Remote condenser air-cooled models
- QuietQube remote condensing unit models
- Ice Beverage remote condensing unit models

NEO® UNDERCOUNTER MODELS

- Self-contained air-cooled models
- Self-contained water-cooled models

NOTE: UDE060 and UDE080 NEO® models are not compatible with LuminIce®.

LuminIce®

The LuminIce® growth inhibitor recirculates the air in the ice machine foodzone over a UV bulb. This process will inhibit the growth of common micro-organisms on all exposed foodzone surfaces.

- All LuminIce® bulbs require replacement on a yearly basis. Although the bulb will still illuminate after 12 months, the effectiveness of the bulb diminishes as operational hours increase. To retain maximum effectiveness, replace the bulb on a 12 month schedule.
- LuminIce® II has an indicator light that will illuminate red when the bulb needs replacement. A remote LED is available as an accessory (K00455) to allow the reminder to be viewed without removing the ice machine panels.
- Indigo® and Indigo® NXT models can be set to automatically display an on screen reminder after 12 months. Refer to Section 3 LuminIce® setup procedure for full details.

LuminIce® Kits

Ice Machine	LuminIce® II NOTE: These kits are used with Indigo® NXT control boards with a built-in LuminIce® transformer.	LuminIce® II NOTE: These kits are used with Indigo® non touchscreen models.	LuminIce®
22" & 30" Single Evaporator I0300 through I1000	K00464	K00450	K00424
48" or Dual Evaporator	K00465	K00451	K00434
NEO® Models	N/A	K00452	K00440

LuminIce® Replacement Bulbs

NOTE: Bulbs are not interchangeable between LuminIce® versions.

Model	Replacement Bulb
LuminIce® II	K00454
LuminIce®	K00425

Before You Begin Installation

Remove all packing material and inspect the equipment for concealed shipping damage. If damage is found, notify the shipper immediately.

LuminIce® II and LuminIce® are for use on Indigo® NXT, Indigo® and NEO® undercounter models, and are not compatible with previous series ice machines or UDE060/UDE080 models.

Section 2 Installation

Indigo® NXT or Indigo® Model 22" & 30" Wide Single Evaporator Installation

⚠ Warning

Disconnect power to ice machine at the electrical disconnect. Pressing the power button does not disconnect line voltage.

1. Disconnect all power to the ice machine at the electrical disconnect.
2. To allow access for the LuminIce® tubing, the evaporator dust cover and plastic caps in the evaporator and compressor compartment bulkhead wall must be removed and discarded.

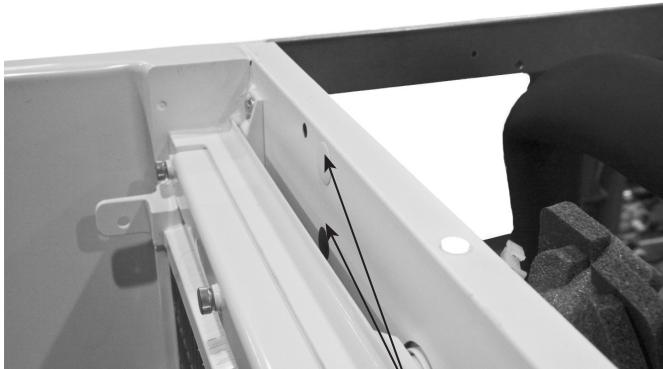

Remove Plastic Caps From Bulkhead In The Evaporator And Compressor Compartment



3. Assemble bracket to left-hand top rail with three provided screws.

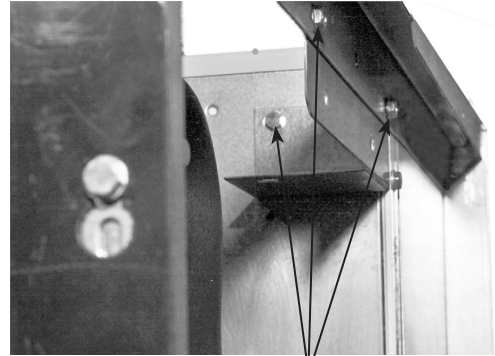

Mount Bracket With Three Screws

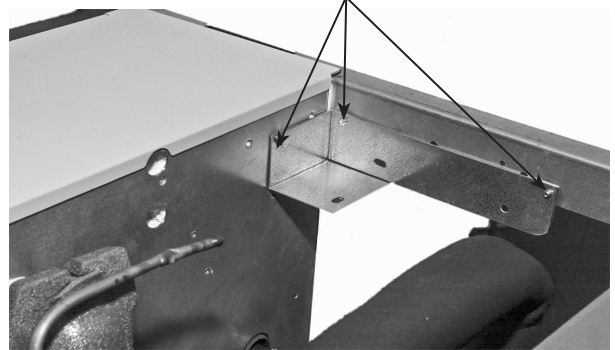

4. Assemble LuminIce® to bracket with three screws provided. The bulb and bulb wiring must face toward the rear of the ice machine to allow bulb replacement with LuminIce® in place.



Attach With
Three Screws

5. Refer to picture and install LuminIce® hoses, wire clip and secure wires to clip.

Install wire clip and route wires along evaporator bulkhead

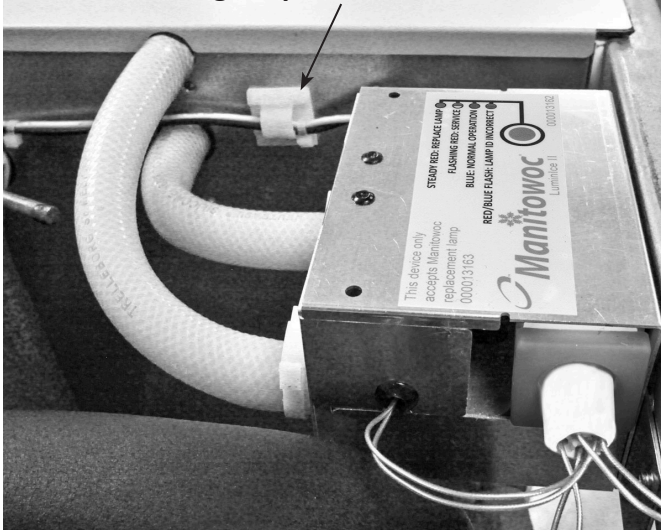

6. Install the notched evaporator dust cover from kit.

NOTE: Proceed to the next step for your specific LuminIce® kit number. Installation varies depending on whether power for the LuminIce® is supplied by the control board or a switching power supply needs to be installed.

**K00464 & K00465 INDIGO® NXT MODELS
LOW VOLTAGE WIRE INSTALLATION**

Power is supplied from the control board.

1. Route the low voltage wiring harness from the control board to the LuminIce®. Install wire clip and route wires close to evaporator bulkhead to assure harness is away from any moving parts, then snap wire harness connectors together.
2. Route the low voltage wiring harness through the control box low voltage Heyco fitting and connect to the control board LuminIce® connector.

LuminIce® Connector

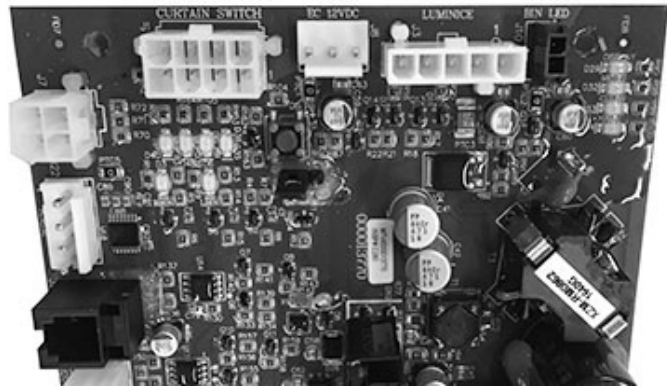

3. Test run the ice machine and LuminIce®. A noticeable draft will be emitted from the upper hose adapter during operation.

K00424, K00434, K00440, K00450, K00451, K00452 INDIGO® MODEL POWER SUPPLY INSTALLATION PROCEDURE

30" Model Power Supply Mounting

Mount power supply on evaporator bulkhead above control box. Attach supplied wire clip and route line voltage wires through clip.

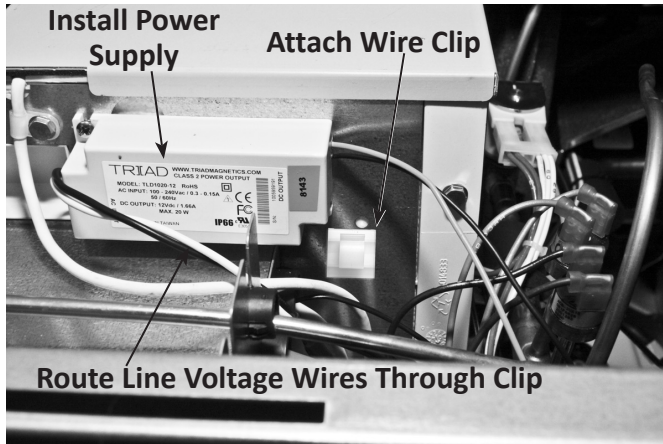

22" Model Power Supply Mounting

The power supply for the 22" model mounts behind the control board, below the access fittings. Route line voltage wires (black & white) through line voltage Heyco fitting and attach to L1 and L2 contactor terminals.

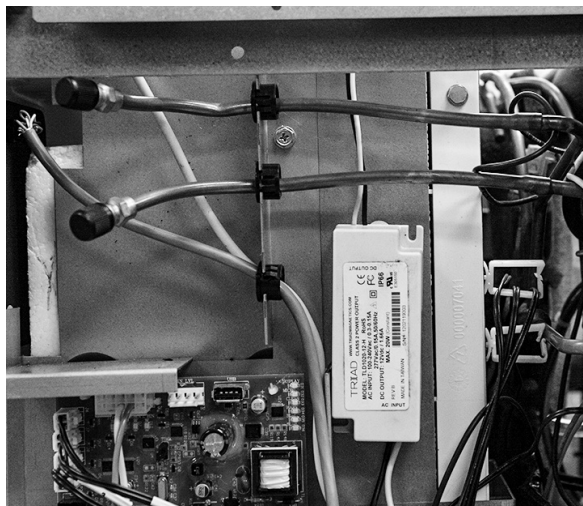

1. Route low voltage wiring (black and yellow wires) to the LuminIce®. Install wire clip and route wires close to evaporator bulkhead to assure harness is away from any moving parts, then snap wire harness connectors together.
2. Route the line voltage wires (black & white) through line voltage Heyco fitting and attach to L1 and L2 contactor terminals.

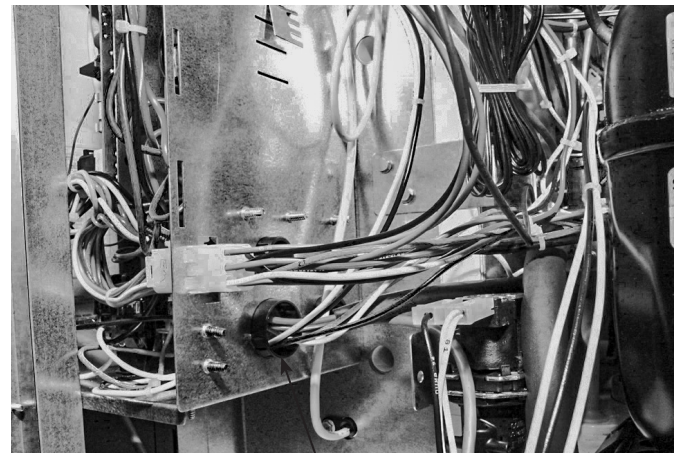

Route Through Line Voltage Heyco and Attach to Contactor Terminals

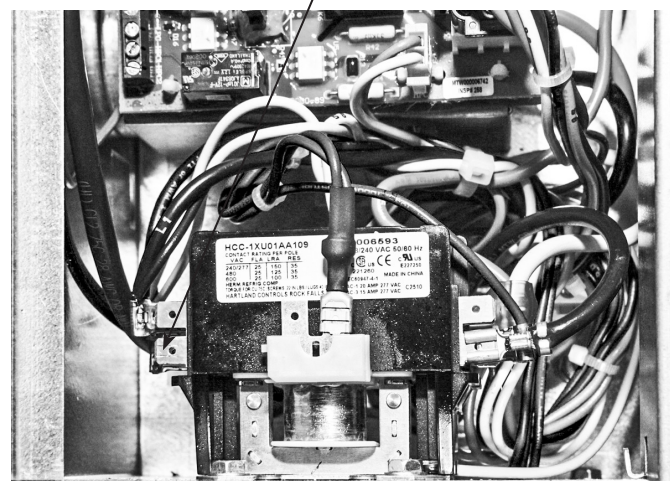

NOTE: QuietQube models do not have open terminals on contactor. Remove two wires from contactor, install supplied electrical connector and connect wires.

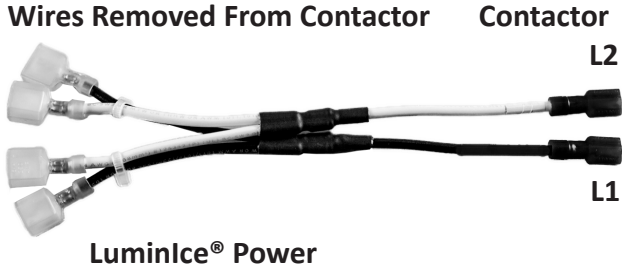

3. Test run the ice machine and LuminIce®. The LuminIce® is energized whenever power is applied to the ice machine. A noticeable draft will be emitted from the upper hose adapter during operation.

Indigo® NXT or Indigo® Model 48" Wide Single Evaporator Installation K00451 Indigo® & K00465 Indigo® NXT

⚠Warning
 Disconnect power to ice machine at the electrical disconnect. Pressing the power button does not disconnect line voltage.

1. Disconnect all power to the ice machine at the electrical disconnect.
2. To allow access for LuminIce® tubing, the plastic caps in the evaporator and compressor compartment bulkhead wall must be removed and discarded. Remove the evaporator dust cover to access lower cap.

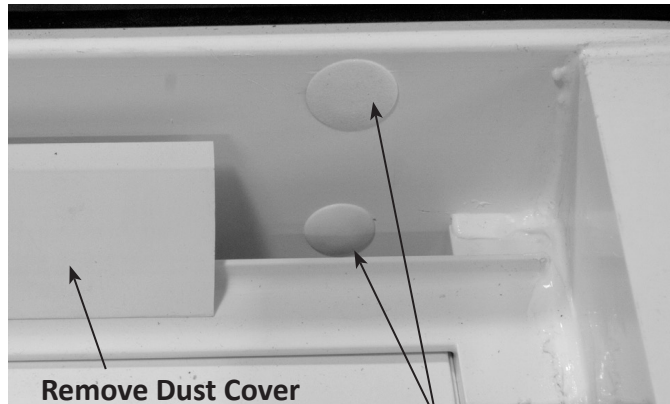

Remove Plastic Caps From Bulkhead In The Evaporator And Compressor Compartment

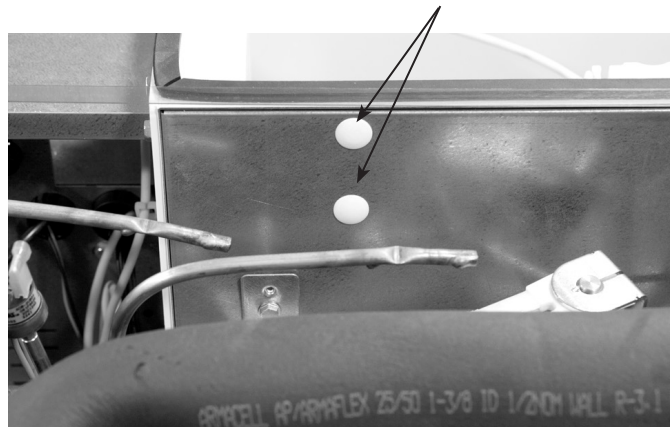

- Remove bracket from ice machine and assemble LuminIce®, tubing and secure with hose clamps.

NOTE: Attach power supply as shown below for Indigo® models (K00451) - Indigo® NXT models (K00465) power the LuminIce® from the control board.

- Assemble bracket to ice machine.

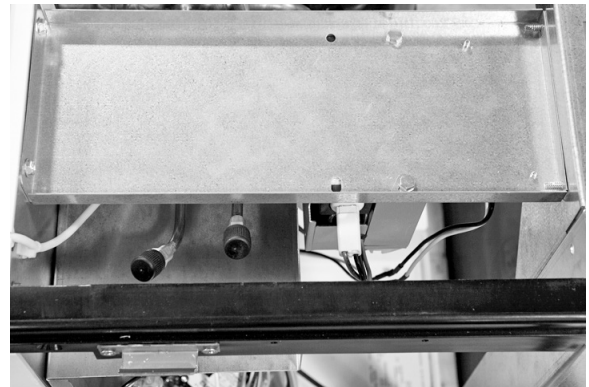
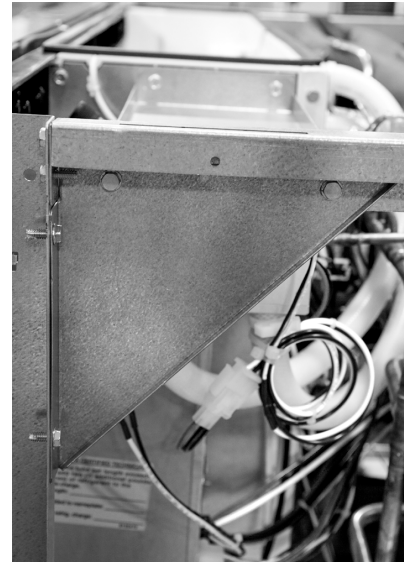

Mount LuminIce® And Power Supply To Bracket
Indigo® Models Only

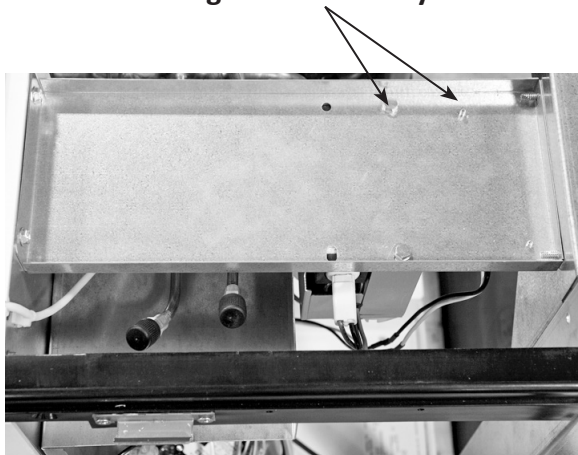

NOTE: Proceed to the next step for your specific LuminIce® kit number. Installation varies depending on whether power for the LuminIce® is supplied by the control board or a switching power supply needs to be installed.

K00465 INDIGO® NXT MODELS LOW VOLTAGE WIRE INSTALLATION

Step 1 Route the low voltage wiring harness from the control board to the LuminIce®. Install wire clip and route wires close to evaporator bulkhead to assure harness is away from any moving parts, then snap wire harness connectors together.

Step 2 Route the low voltage wiring harness through the control box low voltage Heyco fitting and connect to the control board LuminIce® connector.

LuminIce® Connector

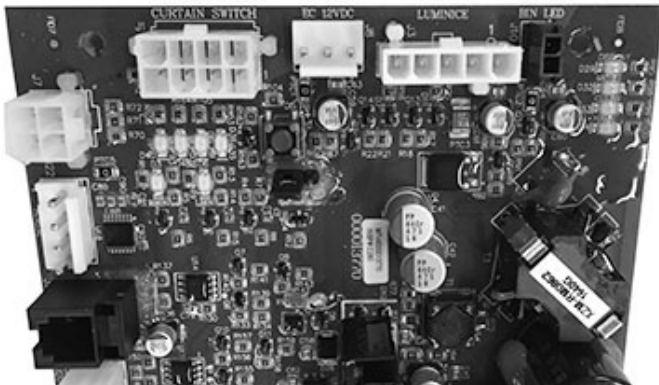

Step 3 Test run the ice machine and LuminIce®. A noticeable draft will be emitted from the upper hose adapter during operation.

K00424, K00434, K00440, K00450, K00451, K00452 INDIGO® MODEL POWER SUPPLY INSTALLATION PROCEDURE

Power Supply Mounting

Step 1 Route line voltage wires (black & white) through line voltage Heyco fitting and attach to L1 and L2 contactor terminals.

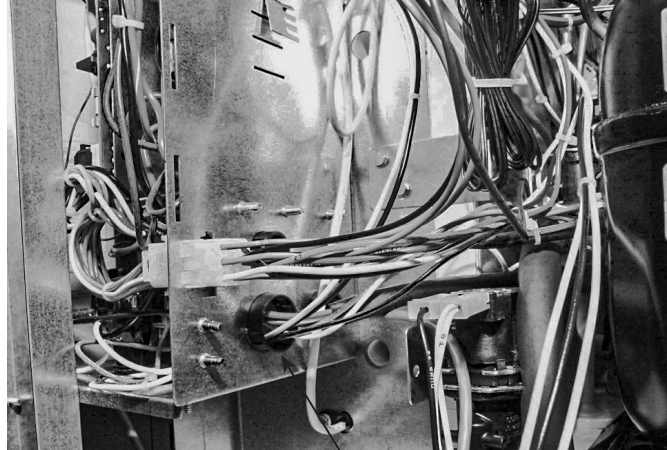

Route Through Line Voltage Heyco and Attach to Contactor Terminals

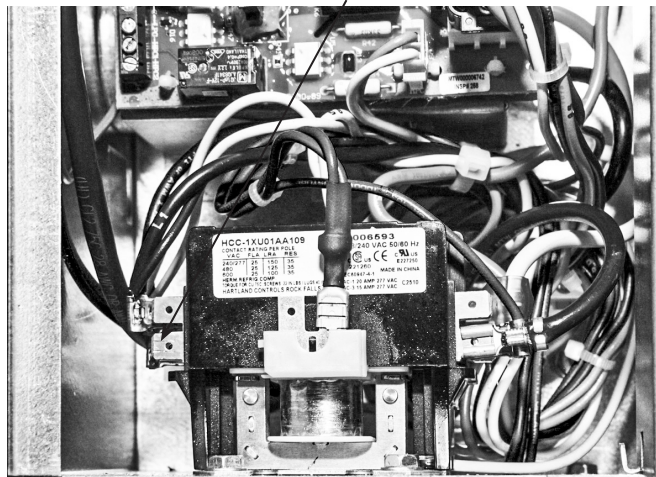

NOTE: Three phase models do not have open terminals on contactor. Remove two wires from contactor, install supplied electrical connector and connect wires.

Wires Removed From Contactor

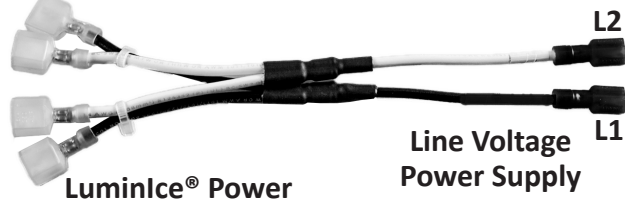

Step 2 Route LuminIce® hoses to evaporator and attach.

- Insert hose closest to the control box in the bottom evaporator bulkhead hole.
- Insert the other hose in the upper evaporator bulkhead hole.



5. Install the evaporator dust cover and test run the ice machine and LuminIce®. The LuminIce® is energized whenever power is applied to the ice machine.

Indigo® NXT or Indigo® Two-Evaporator Ice Machine Model Installation K00434, K00451 Indigo® & K00465 Indigo® NXT

⚠ Warning

Disconnect power to ice machine at the electrical disconnect. Pressing the power button does not disconnect line voltage.

1. Disconnect all power to the ice machine at the electrical disconnect.
2. To allow access for LuminIce® tubing, the plastic caps in the evaporator compartment bulkhead wall must be removed and discarded. Cap located behind evaporator will fall into the water trough. Remove water trough to retrieve cap, then discard.



3. Cut hose to length.
 - Cut one hose 8" (20 cm) long.
 - Cut one hose 18" (46 cm) long.
4. Assemble LuminIce®.
 - Assemble LuminIce® to bracket.
 - Install tubing and secure with hose clamps.
 - Insert a tubing adapter into each hose.

NOTE: The bulb and bulb wiring must face toward the top of the ice machine to allow bulb replacement with LuminIce® in place.

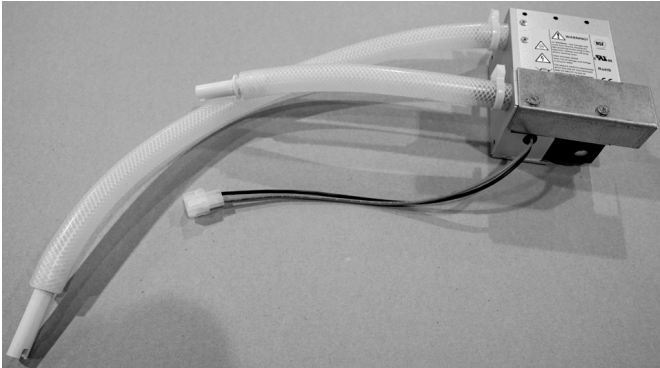

5. Attach LuminIce® assembly to corner post with two screws.



6. Refer to picture and install LuminIce® hoses.



NOTE: Proceed to the next step for your specific LuminIce® kit number. Installation varies depending on whether power for the LuminIce® is supplied by the control board or a switching power supply needs to be installed.

K00465 INDIGO® NXT MODELS LOW VOLTAGE WIRE INSTALLATION

Step 1 Route the low voltage wiring harness from the control board to the LuminIce®. Install wire clip and route wires close to evaporator bulkhead to assure harness is away from any moving parts, then snap wire harness connectors together.

Step 2 Route the low voltage wiring harness through the control box low voltage Heyco fitting and connect to the control board LuminIce® connector.

LuminIce® Connector

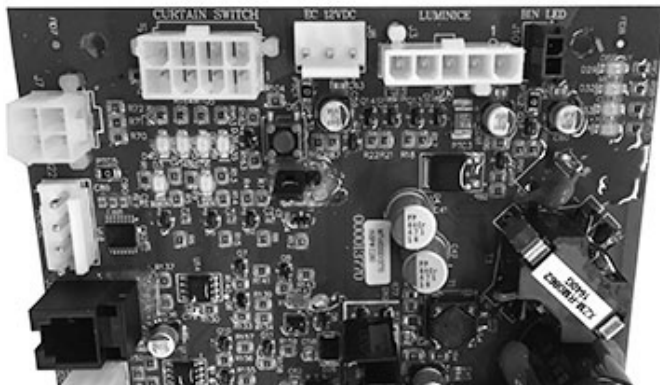

Step 3 Test run the ice machine and LuminIce®. A noticeable draft will be emitted from the upper hose adapter during operation.

K00434, K00451 INDIGO® MODEL POWER SUPPLY INSTALLATION PROCEDURE

Step 1 Mount power supply to evaporator bulkhead.



Step 2 Route line voltage wires (black & white) through line voltage Heyco fitting. Disconnect L1 & N wires and install L1 & N of wiring adapter to the incoming power supply wires. Connect removed wires and LuminIce® wires to adapter.



Incoming Power Supply Ice Machine Power



- Remove four screws to allow access for low voltage wire routing.

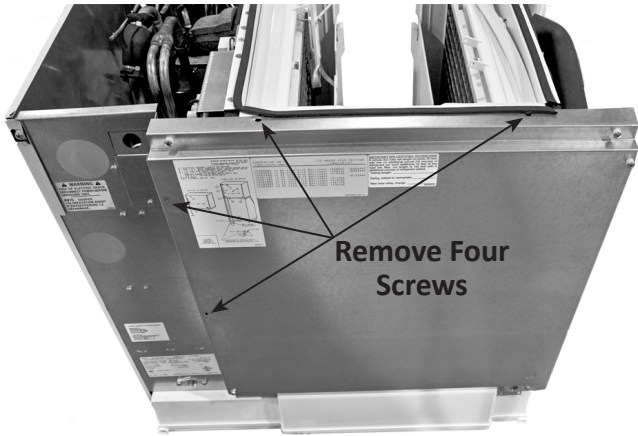

- Route low voltage wiring (black and yellow wires) to the LuminIce®, and snap wire harness connectors together. Reinstall screws removed in previous step.



- Install the evaporator dust cover and test run the ice machine and LuminIce®. The LuminIce® is energized whenever power is applied to the ice machine. A noticeable draft will be emitted from the upper hose adapter during operation.

NEO® Undercounter Model Installation

⚠ Warning

Disconnect power to ice machine at the electrical disconnect. Pressing the power button does not disconnect line voltage.

- Disconnect all power to the ice machine at the electrical disconnect.
- Remove any ice from the bin, then remove bin to allow easier access.
 - On the rear of the ice machine, remove 2 screws that secure the top cover, then remove the top cover.
 - Remove two screws from the front grill, then pull forward to remove grill.
 - Remove bin drain on left side of ice machine.
 - Rotate the latches on the left and right side of the base to release the bin.
 - Disconnect the control pad wiring on the right side from the control box.
 - Slide the bin forward and remove.

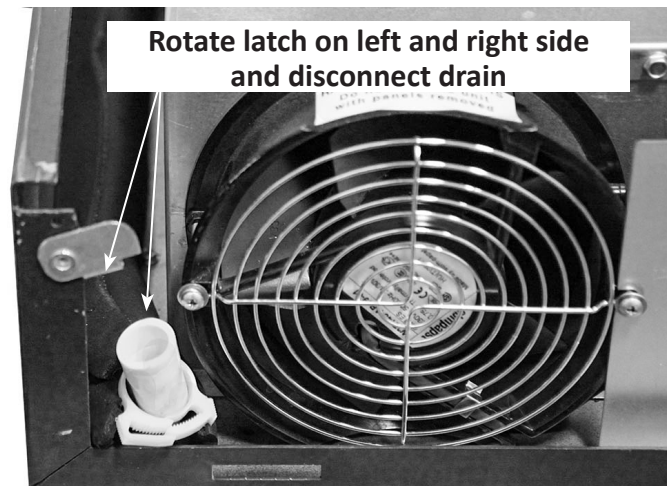

3. To allow access for LuminIce® tubing, the plastic caps in the bulkhead wall must be removed and discarded. The cap located behind the evaporator will fall into the water trough. Remove water trough to retrieve, then discard cap and reinstall the water trough.
4. Assemble bracket, hoses and wires to LuminIce® module.
 - Short hose will route to access hole behind the evaporator. Attach 90 degree elbow to one end and attach other end to LuminIce®.
 - Long hose will route to the access hole above the float switches. Attach 90 degree elbow to one end and attach other end to LuminIce®.
 - Route low voltage wiring (black and yellow wires) to the LuminIce® module and snap wire harness connectors together.
 - Attach both hoses to the bulkhead by pressing in place.
 - Secure excess wire to LuminIce® tubing.



5. Mount LuminIce® to ice machine with 2 screws.



6. Mount power supply on the left side with two screws.

NOTE: Clearance holes for mounting the LuminIce® are factory installed. Depending on model, the power supply may mount vertically or horizontally.



7. Route and secure line voltage wires (black & white) with the power cord. Wires must enter control box through line voltage Heyco fitting and attach to L1 and L2 contactor terminals.



Connect to
L1 & L2 of
Contactor



8. Reinstall bin, wire connectors and all panels, then test run. A noticeable draft will be emitted from the upper hose adapter during operation.

Ice Beverage (IB) Single Evaporator Model Installation

⚠ Warning

Disconnect power to ice machine at the electrical disconnect. Pressing the power button does not disconnect line voltage.

1. Disconnect all power to the ice machine at the electrical disconnect.
2. Install tubing adapters into bulkhead:
 - Remove dust cover from top of evaporator to expose space between the evaporator and bulkhead.
 - Remove and discard plastic caps to allow installation of tubing adapters.
 - Install the longer tubing adapter in the upper evaporator compartment bulkhead location.
 - Install the shorter tubing adapter in the lower evaporator compartment bulkhead location.

3. Mount the LuminIce® and transformer to the mounting bracket.
 - Mount the components on the opposite side of the bracket lip. The bracket lip will slide between the top rail and insulation when mounted.
 - LuminIce® - The bulb and bulb wiring must face up to allow bulb replacement with the LuminIce® in place. Mount the LuminIce® on the left side of the bracket.
 - Power supply - Mount the power supply to the right of the LuminIce®.
4. Install mounting plate in ice machine and secure with fasteners. The mounting plate has pass-through holes for the hose adapters.

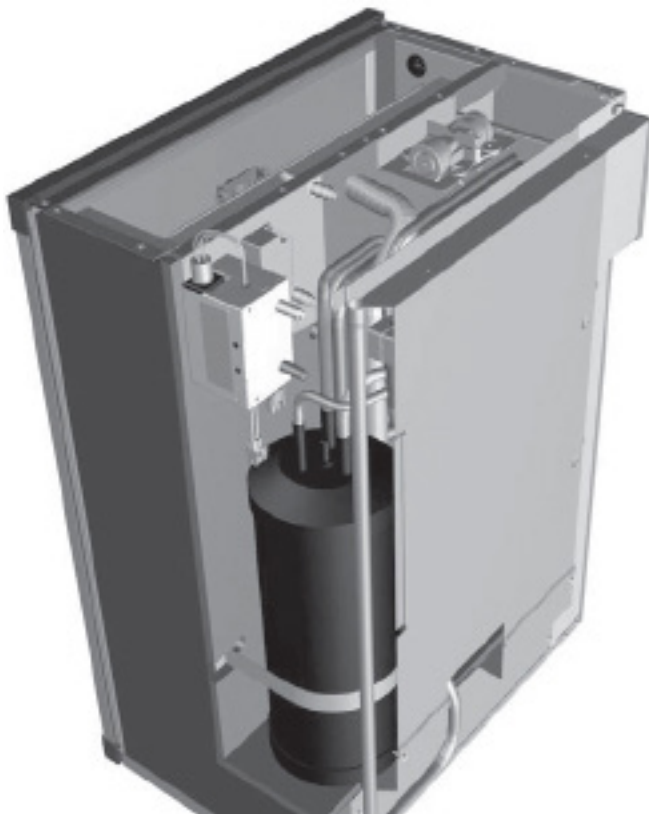

5. Disconnect L1 & N wires and install L1 & N of wiring adapter to the incoming power supply wires. Connect removed wires and LuminIce® wires to adapter.

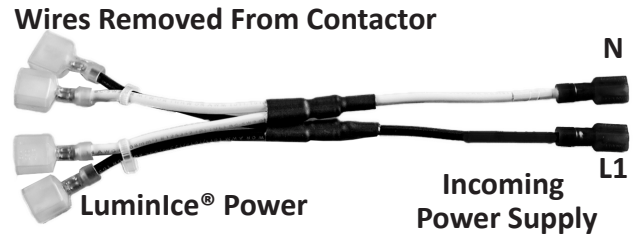

6. Route transformer low voltage wiring (black and yellow wires) to the LuminIce®. Snap the wire harness connectors together. Bundle and secure any excess low voltage wires near the transformer.
7. Cut the LuminIce® hose to length and attach:

NOTE: The upper bulkhead adapter connects to the upper connector on the LuminIce® and the lower bulkhead adapter connects to the lower LuminIce® connector.

- Insert tubing onto the lower bulkhead adapter and dry fit to establish length, then cut to fit. Attach to LuminIce® and secure with snap clamp.
 - Insert tubing onto the upper bulkhead adapter and dry fit to establish length, then cut to fit. Attach to LuminIce® and secure with snap clamp.
 - Reinstall the evaporator dust cover.
8. Test run:
 - Install all panels except the front panel.
 - Restore power - The LuminIce® is energized whenever power is applied to the ice machine. A noticeable draft will be emitted from the upper hose adapter during operation.

THIS PAGE INTENTIONALLY LEFT BLANK

Section 3 Maintenance

Replacement Bulb Usage

Replacement bulbs are not interchangeable between LuminIce® and LuminIce® II.

- LuminIce® replacement bulb - K00425
- LuminIce® II replacement bulb - K00454

LUMINICE® II INDICATOR LIGHTS

LuminIce® II has an LED light for status indication:

- Steady red light = Replace bulb
- Flashing red light = Service is required
- Blue = Normal operation
- Red/Blue flash = Incorrect replacement bulb has been installed.

Bulb Replacement Frequency

LuminIce® and LuminIce® II bulbs require replacement on a yearly basis. Although the bulb will still illuminate after 12 months, the effectiveness of the bulb diminishes as operational hours increase. To retain maximum effectiveness, replace the bulb on a 12 month schedule.

LuminIce® II has an indicator light that will illuminate red when the bulb needs replacement. A remote LED is available as an accessory (K00455) to allow all indicators (including the reminder) to be viewed without removing the ice machine panels.

LuminIce® Reminder Setup for Indigo® NXT & Indigo® Model Ice Machines

Complete display panel navigation is available in the Indigo® and Indigo® NXT ice machine Installation, Operation and Maintenance Manual. Publications for all Manitowoc equipment is available on our website www.manitowocice.com.

INDIGO® TOUCHSCREEN MODELS

When a LuminIce® is installed the touchscreen will display a blue light. This light will change to red when bulb replacement is due.

INDIGO® MODELS WITHOUT TOUCHSCREEN

Perform the procedure below to display a change-bulb reminder every 12 months.

1. From the Set-Up menu, use the Down arrow to highlight LuminIce®.
2. Press the Check mark. On this screen, you can choose to turn the reminder to AUTO or OFF by highlighting your choice and pressing the Check mark. Selecting one will deselect the other.
3. When the check reflects your preference, use the Down arrow to navigate to Exit and press the Check mark. The display will return to the Set-Up menu.

Bulb Replacement

⚠ Warning

Disconnect power to ice machine at the electrical disconnect. Pressing the power button does not disconnect line voltage.

1. Disconnect all power to the ice machine at the electrical disconnect.
2. Open the front door of the ice machine and then remove the top panel.
3. Disconnect the power connector from the LuminIce® bulb.



4. Push bulb with finger and pull with other hand toward the rear of the ice machine until bulb is free.



5. Remove retainer from old bulb and install on replacement bulb.

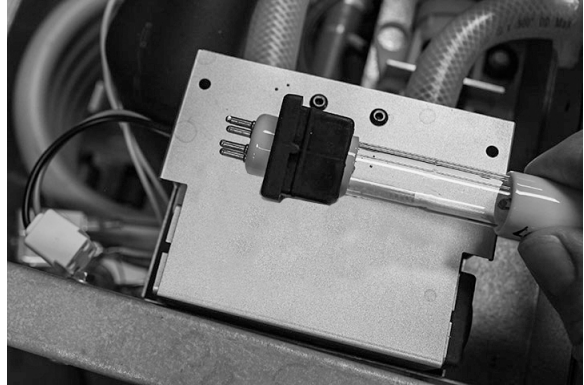

6. Align slot on LuminIce® and notch on retainer and install replacement bulb in LuminIce®.



7. Insert bulb until it seats in the retainer stop on the opposite end.



8. Attach connector to bulb.

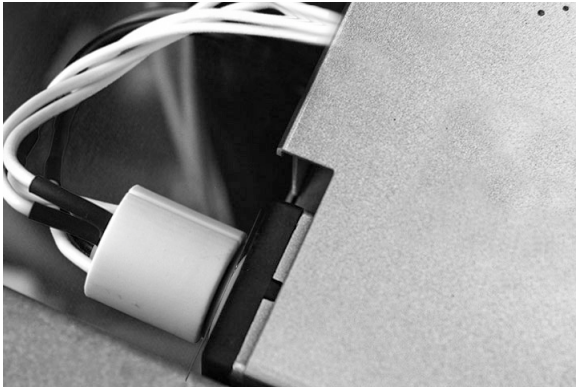

9. Reinstall panels and reapply power - The LuminIce® is energized whenever power is applied to the ice machine.
10. Dispose of the old bulb - The bulb contains mercury, like other fluorescent and CFL bulbs and is disposed in the same manner. Refer to epa.gov for information on recycling requirements and locations in your area.

Cleanup Procedure for Accidental Bulb Breakage

The cleanup procedure is identical to the procedure used to clean up compact fluorescent (CFL) or fluorescent tube lights. These lights contain a small amount of mercury sealed within a glass tube. Breaking these types of lights will release mercury and mercury vapor. The broken bulb can continue to release mercury vapor until it is cleaned up and removed.

To minimize exposure to mercury vapor, the EPA (Environmental Protection Agency) recommends the following cleanup and disposal steps.

This cleanup guidance represents the minimum actions recommended to clean up a broken light containing mercury, and will be updated if the EPA identifies more effective cleanup practices.

The latest EPA procedures can be viewed on their website at www.epa.gov/cfl/cflcleanup.html.

BEFORE CLEANUP

- Have people and pets leave the room, and avoid the breakage area on the way out.
- Open a window or door to the outdoors and leave the room open for 5 - 10 minutes.
- Shut off the central forced air heating/air conditioning (H&AC) system.
- Collect materials you will need to clean up the broken bulb:
 - A. Stiff paper or cardboard
 - B. Sticky tape (e.g., duct tape)
 - C. Damp paper towels or disposable wet wipes (for hard surfaces)
 - D. Glass jar with a metal lid (such as a canning jar) or a seal-able plastic bag(s)

DURING CLEANUP

- Be thorough in collecting broken glass and visible powder.
- Place cleanup materials in a sealable container.

AFTER CLEANUP

- Promptly place all bulb debris and cleanup materials outdoors in a trash container or protected area until materials can be disposed of properly. Avoid leaving any bulb fragments or cleanup materials indoors.
- If practical, continue to air out the room where the bulb was broken and leave the heating/air conditioning system shut off for several hours.

Cleanup Steps for Hard Surfaces

1. Carefully scoop up glass fragments and powder using stiff paper or cardboard and place debris and paper/cardboard in a glass jar with a metal lid. If a glass jar is not available, use a sealable plastic bag.

NOTE: Since a plastic bag will not prevent the mercury vapor from escaping, remove the plastic bag(s) from the home after cleanup.

2. Use sticky tape, such as duct tape, to pick up any remaining small glass fragments and powder. Place the used tape in the glass jar or plastic bag.
3. Wipe the area clean with damp paper towels or disposable wet wipes. Place the towels in the glass jar or plastic bag.

NOTE: Vacuuming of hard surfaces during cleanup is not recommended unless broken glass remains after all other cleanup steps have been taken. It is possible that vacuuming could spread mercury containing powder or mercury vapor, although available information on this problem is limited.

If vacuuming is needed to ensure removal of all broken glass, keep the following tips in mind:

- Keep a window or door to the outdoors open.
- Vacuum the area where the bulb was broken using the vacuum hose, if available; and remove the vacuum bag (or empty and wipe the canister) and seal the bag/vacuum debris, and any materials used to clean the vacuum, in a plastic bag.
- Promptly place all bulb debris and cleanup materials, including vacuum cleaner bags, outdoors in a trash container or protected area until materials can be disposed of properly.
- Check with your local or state government about disposal requirements in your area. Some states and communities require fluorescent bulbs (broken or unbroken) be taken to a local recycling center.
- Wash your hands with soap and water after disposing of the jars or plastic bags containing bulb debris and cleanup materials.
- Continue to air out the room where the bulb was broken and leave the H&AC system shut off, as practical, for several hours.

Cleanup Steps for Carpeting or Rugs

1. Carefully scoop up glass fragments and powder using stiff paper or cardboard and place debris and paper/cardboard in a glass jar with a metal lid. If a glass jar is not available, use a sealable plastic bag.

NOTE: Since a plastic bag will not prevent the mercury vapor from escaping, remove the plastic bag(s) from the home after cleanup.

2. Use sticky tape, such as duct tape, to pick up any remaining small glass fragments and powder. Place the used tape in the glass jar or plastic bag.

NOTE: Vacuuming of hard surfaces during cleanup is not recommended unless broken glass remains after all other cleanup steps have been taken. It is possible that vacuuming could spread mercury containing powder or mercury vapor, although available information on this problem is limited.

If vacuuming is needed to ensure removal of all broken glass, keep the following tips in mind:

- Keep a window or door to the outdoors open.
- Vacuum the area where the bulb was broken using the vacuum hose, if available; and remove the vacuum bag (or empty and wipe the canister) and seal the bag/vacuum debris, and any materials used to clean the vacuum, in a plastic bag.
- Promptly place all bulb debris and cleanup materials, including vacuum cleaner bags, outdoors in a trash container or protected area until materials can be disposed of properly.
- Check with your local or state government about disposal requirements in your area. Some states and communities require fluorescent bulbs (broken or unbroken) be taken to a local recycling center.
- Wash your hands with soap and water after disposing of the jars or plastic bags containing bulb debris and cleanup materials.
- Continue to air out the room where the bulb was broken and leave the H&AC system shut off, as practical, for several hours.

FUTURE CLEANING OF CARPETING OR RUGS

1. Air out the room during and after vacuuming.
2. The next several times you vacuum the rug or carpet:
 - A. Shut off the H&AC system.
 - B. Close the doors to other rooms.
 - C. Open a window or door to the outside before vacuuming.
 - D. Change the vacuum bag after each use in this area.

NOTE: After vacuuming is completed, keep the H&AC system shut off and the window or door to the outside open, as practical, for several hours.



MANITOWOC ICE
2110 SOUTH 26TH STREET, MANITOWOC, WI 54220

800-545-5720
WWW.MANITOWOCICE.COM