



**Congratulations!**

You have just purchased the finest commercial refrigerator available. You can expect many years of trouble-free operation.

**Table of Contents**

**Safety Information**  
Safety Precautions & Proper Disposal .....3

**Prior to Installation**  
Ownership .....4  
Cabinet Specification & Location .....4  
Notice to Customer .....4

**Installation**  
Wiring Instruction Advisement .....5  
Wire Gauge Chart .....5  
Uncrating .....6  
Leveling Leg, 6" Leveling Leg & Castor Installation .....7  
Locating and Leveling .....7  
Sealing Cabinet to the Floor .....8  
Electrical Installation & Safety ..... 10

**Cabinet Setup**  
Standard Accessories ..... 11  
Shelf Installation and Adjustment ..... 11

**Cabinet Operation**  
Startup ..... 13  
Temperature Control & Light Switch Location ..... 13

**Maintenance, Care, Cleaning**  
Condenser Coil Cleaning ..... 15  
Stainless Steel Care & Cleaning & 8 Tips to Help Prevent Rust ... 17

**Cabinet Adjustments, Servicing & Component Replacement**  
Servicing & Replacing Components..... 18  
Slide Door Operation – Door Removal ..... 18  
Slide Door Operation – Door Adjustment .....20  
Slide Door Operation – Hold-Open Feature .....20

**Warranty**  
Warranty ..... 21



GDM-26-HC-TSL01



GDM-49-HC-TSL01



GDM-69-HC-LD



**INSTALLATION MANUAL  
GDM FREEZER/REFRIGERATOR**

Original Instructions

**TRUE MANUFACTURING CO., INC.**

2001 East Terra Lane • O'Fallon, Missouri 63366-4434  
(636)-240-2400 • FAX (636)-272-2408 • International FAX (636)272-7546 • (800)-325-6152  
Parts Department (800)-424- TRUE • Parts Department FAX# (636)-272-9471

**North America – Canada and Caribbean**  
Warranty Phone: +1 855 878 9277  
Warranty Fax: +1 636 980 8510  
Technical Phone: +1 855 372 1368  
Warranty Email: warrantyinquiries@truemfg.com  
Technical Email: service@truemfg.com  
7:00 – 7:00 CST Monday – Thursday.  
7:00 – 6:00 Friday. 8:00 – 12:00 Saturday.

**Mexico**  
Phone: +52 555 804 6343/44  
Toll Free in Mexico: 01 800 202 0687  
service-mexicocity@truemfg.com  
9:00 am – 5:30 pm M–F

**Latin America**  
Phone: +56 232 13 3600  
servicelatam@truemfg.com  
9:00 am – 5:30 pm M–F

**UK, Ireland, Middle East, Africa and India**  
Phone: +44 (0) 800 783 2049  
service-emea@truemfg.com  
8:30 am – 5:00 pm M–F

**European Union and Commonwealth of Independent States**  
Phone: +49 (0) 7622 6883 0  
service-emea@truemfg.com  
8:00 am – 5:00 pm M–F

**Australia**  
Phone: +61 2 9618 9999  
service-aus@truemfg.com  
8:30 am – 5:00 pm M–F



975536

THANK YOU

FOR YOUR PURCHASE

## How to Maintain Your True Refrigerator to Receive the Most Efficient and Successful Operation

You have selected one of the finest commercial refrigeration units made. It is manufactured under strict quality controls with only the best quality materials available. Your TRUE cooler, when properly maintained, will give you many years of trouble-free service.

**WARNING** – Use this appliance for its intended purpose as described in this Installation Manual.

### Refrigerant Safety & Warning Information

See the serial label inside the cabinet for the units refrigeration type. For Hydrocarbon Refrigeration (R290 only), see below:



**DANGER** – Risk of fire or explosion. Flammable refrigerant used. **DO NOT** use mechanical devices to defrost refrigerator. **DO NOT** puncture refrigerant tubing; follow handling instructions carefully. To be repaired only by trained service personnel.



**DANGER** – Risk of fire or explosion (flammable refrigerant used), consult repair manual/owner's guide before attempting to service this product. All safety precautions must be followed. Dispose of properly in accordance with local and federal regulations. Follow all safety precautions.

**CAUTION** – Keep all ventilation openings clear of obstruction in the appliance enclosure or in the structure housing the appliance.

### Basic Safety & Warning Precautions

- Take care during operation, maintenance or repairs to avoid cuts or pinching from any part/component of the cabinet.
- Units may pose a tipping hazard while uncrating, during installation, or when moving the unit.
- Ensure the unit is properly installed and located in accordance with the Installation Instructions before use.
- This appliance is not to be used, cleaned or maintained by persons (including children) with reduced physical, sensory or mental capabilities or lack of experience and knowledge, unless they have been given supervision or instruction.
- **DO NOT** allow children to play with the appliance or climb, stand, or hang on the unit's shelves to prevent damage to the refrigerator and personal injury.
- **DO NOT** touch the cold surfaces in the freezer compartment when hands are damp or wet. Skin may stick to these extremely cold surfaces.
- Unplug the refrigerator before cleaning and making repairs.
- Setting temperature controls to the 0 position or powering off an electronic control may not remove power from all components (e.g., light circuits, perimeter heaters, and evaporator fans).
- **DO NOT** store or use gasoline, or other flammable vapors and liquids, in the vicinity of this or any other appliance.
- **DO NOT** store explosive substances such as aerosol cans with a flammable propellant in this appliance.
- Keep fingers out of the "pinch point" areas; clearances between the doors and cabinet are necessarily small; be careful closing doors when children are in the area.
- **DO NOT** use electrical appliances inside the food storage compartments of the units unless the appliances are of the type recommended by the manufacturer.

**NOTE:** All servicing must be performed by a qualified technician.

### Cabinet Disposal Warning

**DANGER!**  
**RISK OF CHILD**  
**ENTRAPMENT**



#### Proper Disposal of the Cabinet

Child entrapment and suffocation are not problems of the past. Junked or abandoned refrigerators are still dangerous, even if they will sit for "just a few days." If you are getting rid of your old refrigerator, please follow the instructions below to help prevent accidents.

#### Before throwing away your old refrigerator or freezer:

- Take off the doors.
- Leave the shelves in place so that children may not easily climb inside.



**DANGER** – Risk of fire or explosion. Flammable insulation and/or refrigerant used. Dispose of all in accordance with local and federal regulations. Follow all safety precautions.

# Prior to Installation

## Ownership

To ensure that your unit works properly from the first day, it must be installed properly. We highly recommend a trained refrigeration mechanic and electrician install your TRUE equipment. The cost of a professional installation is money well spent.

Before you start to install your TRUE unit, carefully inspect it for freight damage. If damage is discovered, immediately file a claim with the delivery freight carrier.

TRUE is not responsible for damage incurred during shipment.

## Cabinet Specification

This appliance is rated for open food storage.

## Cabinet Location

- Appliance tested to IEC EN 60335-2-89 Climate Class 5 [109°F (43°C) temperature, 40% relative humidity] for safety.
- Appliance tested to EN 23953-2:2015 Climate Class 3 [77°F (25°C), 55% relative humidity] for performance.
- For proper operation, ambient temperatures shall not be less than 60°F (15.5°C).
- Appliance is not suitable for outdoor use.
- Appliance is not suitable for an area where a pressure washer or hose may be used.
- Ensure the location will provide adequate clearances and sufficient airflow for the cabinet.
- Ensure the power supply for the cabinet matches the cabinet specification sheet or cabinet data plate and is within the rated voltage (+/-5%). Also, that the amp rating of the circuit is correct and that it is properly grounded.
- The cabinet should always be plugged into its own individual dedicated electrical circuit. The use of adapter plugs and extension cords is prohibited.

## Notice to Customer

Loss or spoilage of products in your refrigerator/freezer is **not covered by warranty**. In addition to following recommended installation procedures, you must run the refrigerator/freezer for 24 hours prior to usage to verify its proper operation.



CLEARANCES			
	TOP	SIDES	BACK
G4SM	0"	0"	1" (25.4 mm)
GDM-05/05F	12" Open (304.8 mm)	1" (25.4 mm)	1" (25.4 mm)
GDM-07F	1" (25.4 mm)	1" (25.4 mm)	3" (76.2 mm)
GDM-10/12/10-58	1" (25.4 mm)	0"	1" (25.4 mm)
GDM-11SD	0"	0"	1" (25.4 mm)
GDM Freezers	3" (76.2 mm)	0"	3" (76.2 mm)
GDM Refrigerators	0"	0"	1" (25.4 mm)
GEM	0"	0"	1" (25.4 mm)

**WARNING** – Warranty is void if ventilation is insufficient.

# Installation (cont.)

## Wiring Instruction Advisement (115V only)

Follow the instructions below to convert your TRUE unit from a 4-wire circuit and a 4-prong NEMA 14-20P (see components in fig. 1) to a 3-wire circuit and a 3-prong NEMA 5-20P (see components in fig. 2).

**NOTE: Power cord conversion kit available for purchase to match current installation location's wiring configuration**



**CAUTION** – It is the customer's responsibility to make sure receptacle wiring meets all local electrical codes. TRUE recommends hiring a licensed qualified electrician to make this change.



**CAUTION** – Electrical shock or burn hazard. Unplug the unit or turn off the power supply before proceeding.

### Wiring Conversion

#### Receptacle Box

1. Turn off the circuit breaker
2. Disconnect the existing receptacle.
3. Cap the red wire.
4. Connect the black, white, and green wires to the 3-prong NEMA 5-20P plug per instructions on the receptacle.

#### Breaker Panel

1. Disconnect and remove the existing double-pole breaker.
2. Install a single-pole breaker
3. Connect the black wire to the replacement breaker
4. Cap the red wire
5. Turn on the circuit breaker.

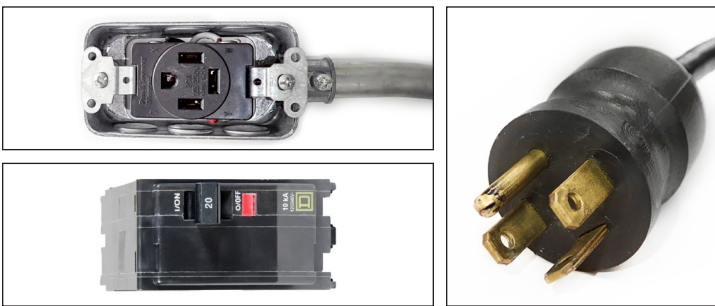

Fig. 1. 4-wire configuration and 4-prong NEMA 14-20P/20R.

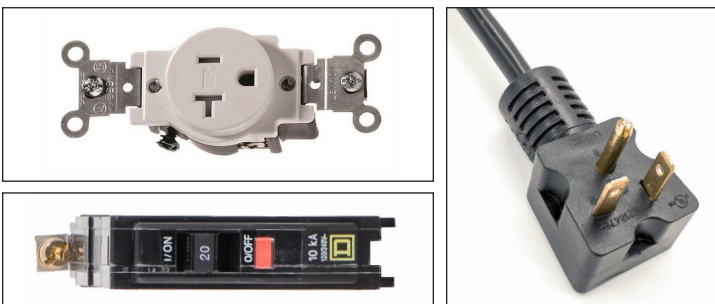

Fig. 2. 3-wire configuration and 3-prong NEMA 5-20P/20R.

## Wire Gauge Chart

115 Volts	Distance In Feet To Center of Load												
	AMPS	20	30	40	50	60	70	80	90	100	120	140	160
2	14	14	14	14	14	14	14	14	14	14	14	14	14
3	14	14	14	14	14	14	14	14	14	14	14	14	12
4	14	14	14	14	14	14	14	14	14	14	12	12	12
5	14	14	14	14	14	14	14	14	12	12	12	10	10
6	14	14	14	14	14	14	14	12	12	12	10	10	10
7	14	14	14	14	14	14	12	12	12	10	10	10	8
8	14	14	14	14	12	12	12	12	10	10	10	8	8
9	14	14	14	12	12	12	10	10	10	8	8	8	8
10	14	14	14	12	12	10	10	10	10	8	8	8	6
12	14	14	12	12	10	10	10	8	8	8	8	6	6
14	14	14	12	10	10	10	8	8	8	8	6	6	6
16	14	12	12	10	10	8	8	8	8	8	6	6	6
18	14	12	10	10	8	8	8	8	8	8	8	8	5
20	14	12	10	10	8	8	8	8	6	6	6	5	5
25	12	10	10	8	8	6	6	6	6	6	5	4	4
30	12	10	8	8	6	6	6	6	5	4	4	4	3
35	10	10	8	6	6	6	5	5	4	4	4	3	2
40	10	8	8	6	6	5	5	4	4	4	3	2	2
45	10	8	6	6	6	5	4	4	3	3	3	2	1
50	10	8	6	6	5	4	4	3	3	3	2	1	1

230 Volts	Distance In Feet To Center of Load												
	AMPS	20	30	40	50	60	70	80	90	100	120	140	160
5	14	14	14	14	14	14	14	14	14	14	14	14	14
6	14	14	14	14	14	14	14	14	14	14	14	14	12
7	14	14	14	14	14	14	14	14	14	14	14	12	12
8	14	14	14	14	14	14	14	14	14	14	12	12	12
9	14	14	14	14	14	14	14	14	14	12	12	12	10
10	14	14	14	14	14	14	14	14	12	12	12	10	10
12	14	14	14	14	14	14	14	12	12	12	10	10	10
14	14	14	14	14	14	12	12	12	10	10	10	8	8
16	14	14	14	14	12	12	12	10	10	10	8	8	8
18	14	14	14	12	12	12	10	10	10	10	8	8	8
20	14	14	14	12	10	10	10	10	10	10	8	8	8
25	14	14	12	12	10	10	10	10	8	8	8	6	6
30	14	12	12	10	10	10	8	8	8	8	6	6	6
35	14	12	10	10	10	8	8	8	8	8	6	6	5
40	14	12	10	10	8	8	8	8	6	6	6	5	5
50	12	10	10	8	6	6	6	6	6	6	5	4	4
60	12	10	8	6	6	6	6	6	5	4	4	4	3
70	10	10	8	6	6	6	5	5	4	4	4	2	2
80	10	8	8	6	6	5	5	4	4	4	3	2	2
90	10	8	6	6	5	5	4	4	3	3	3	1	1
100	10	8	6	6	5	4	4	3	3	3	2	1	1

# Installation (cont.)

## Uncrating

### Tools Required

- Adjustable wrench
- Phillips screwdriver
- Level

The following procedure is recommended for uncrating the unit:

1. Remove the outer packaging (cardboard and bubble wrap or Styrofoam corner and clear plastic). See fig. 1. Inspect for concealed damage. **Again, immediately file a claim with the freight carrier if there is damage.**  
**NOTE: DO NOT** remove the shipping bracket (glass swing doors; fig. 2) or the shipping blocks (glass slide doors; fig. 3) until the unit is installed in its final location. **Do not discard;** use the bracket/blocks when next moving the cabinet.  
**NOTE: DO NOT** remove the shipping bracket (glass swing doors; fig. 2) or the shipping blocks (glass slide doors; fig. 3) until the unit is installed in its final location. **Do not discard;** use the bracket/blocks when next moving the cabinet.
2. With an adjustable wrench, remove all shipping bolts securing the wood skid to the bottom of the cabinet. See fig. 4.  
**NOTE:** Move the unit as close as possible to the final location before removing the wooden skid. Some models may require removing the front and/or rear grill/cover to access the shipping bolts.
3. If leveling legs or castors **will not be used**, remove the cabinet from the wood skid and set the skid aside.  
**NOTE: DO NOT** lift the cabinet by the counter tops, doors, drawers, or grills.

If leveling legs or castors **will be used**, rotate the cabinet on the skid (see fig. 5) and see the installation instructions on pages 7-8.

**NOTE:** Remember to leave cabinet upright for 24 hours before plugging into a power source. Keys for cabinet with door locks are located in the warranty packet.



**WARNING** – Units may pose a tipping hazard while uncrating, during installation, or when moving the unit.



Fig. 1. Remove the exterior packaging.



Fig. 2. Remove the glass swing door shipping bracket, if so equipped. Do not discard.

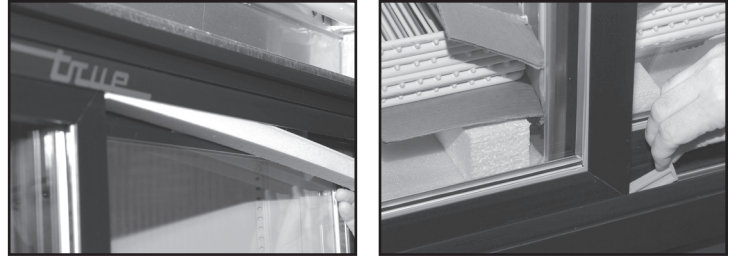

Fig. 3. Glass slide door shipping block locations. Remove if so equipped and do not discard.

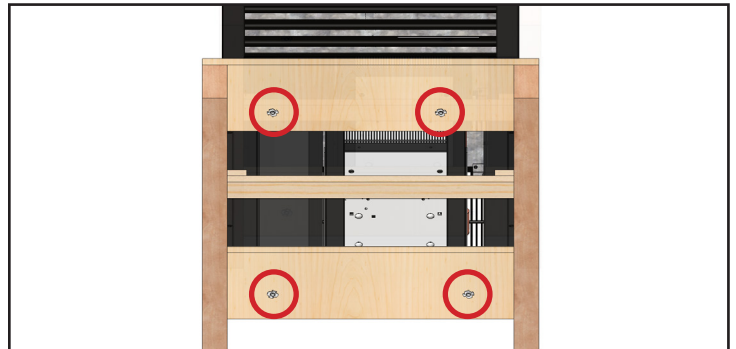

Fig. 4. Shipping bolt locations.

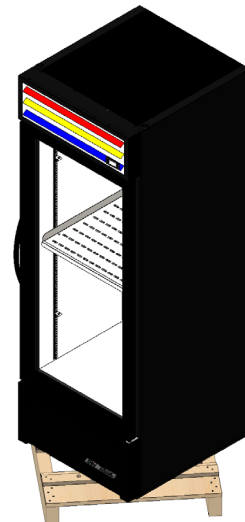

Fig. 5. When lifting unit, do not use counter tops, doors/drawers, or grills as a lifting point.

# Installation (cont.)

## Cabinet Location

1. Ensure that the drain hose or hoses are positioned in the pan.
2. Free the plug and cord from inside the lower rear of the cooler (**DO NOT** plug in).
3. Place the unit close enough to the electrical supply so that the extension cords are never used.

## Installing Leveling Legs

Leveling legs are provided to assist with leveling the cabinet.

With access to the bottom of the cabinet, thread the leveling legs into the holes used to secure the cabinet to the skid. See figs. 1 and 2.

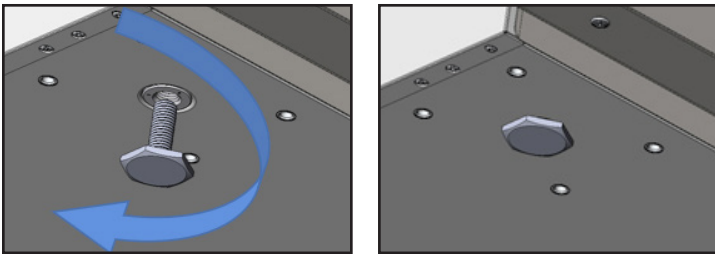

Fig. 1. Turn the leveling legs clockwise to lower the unit.

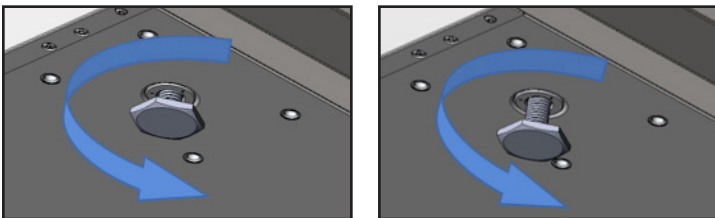

Fig. 2. Turn the leveling legs counterclockwise to raise the unit.

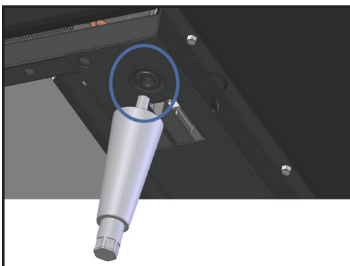

Fig. 3. Locate the threaded hole in the rail.

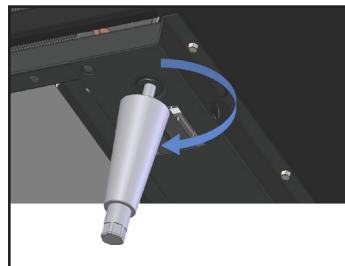

Fig. 4. Screw in the leveling legs.

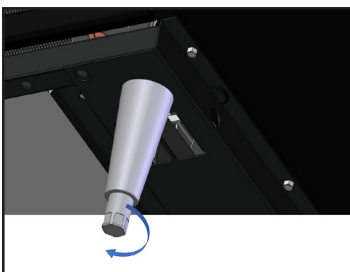
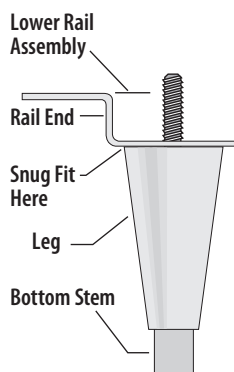

Fig. 5. Turn the bottom stem to level the cabinet.



## Installing 6" Leveling Legs or Castors

Adjustable legs will provide 6" (152 mm) of clearance under the cabinet. Castors provide cabinet mobility.

**NOTE:** If the cabinet has a center leveling screw, castor, or leg, make sure it is adjusted properly so it makes full contact with the floor after the cabinet has been leveled.

### Required Tools

Adjustable Wrench

### 6" Leveling Legs

1. Access the bottom of the cabinet and thread the leveling legs into the rail. See figs. 3 and 4.
2. Verify that the cabinet is level.
3. If the cabinet is not level, gently lift and support the low end of the cabinet. With an adjustable wrench, screw the bottom stem of the leveling leg in or out to level and support the cabinet. See fig. 5.

### Castors

1. Loosen the castor bolt enough to slide the provided castor shims between the castor bearing and the bottom rail of the cabinet. See fig. 6.
2. Install the desired number of shims. If more than one shim is used, turn the slots at a 90° angle to each other, so the slots do not align. See figs. 7 and 8.
3. Tighten and secure the shims and castors with the optional castor wrench. Lower the cabinet and verify that it is level. If the cabinet is not level, repeat the process until the cabinet is level and supported.

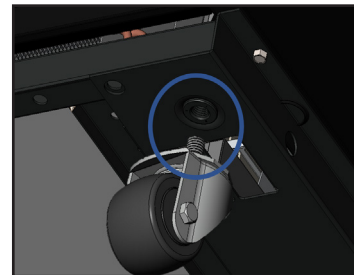

Fig. 6. Loosen castor bolt.

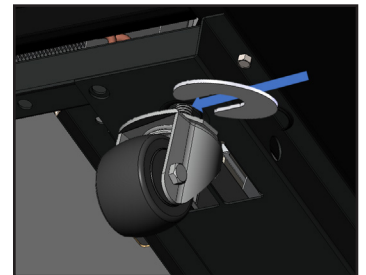
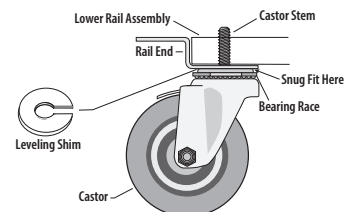

Fig. 7. Install shim(s).



Fig. 8. Position multiple shims at 90° angles.



## Installation (cont.)

### Installing optional castors on GDM-10 & 12 models

1. Position Styrofoam or cardboard on the floor behind the unit.
2. Carefully lay the unit on its back.
3. With a Phillips screwdriver, remove the front louver grill.
4. Remove the shipping bolts.
5. Install the castors in the threaded holes.  
NOTE: Be sure to position the castors with handbrakes at the front of the cabinet.
6. Position the front castors forward and engage the brakes.  
Warning - Unit may tip if the front castors are not positioned forward and locked.
7. Install the front louver grill.
8. Carefully lift the unit.  
NOTE: To avoid damage to the lower rail assembly, slowly upright the unit.
9. Verify the unit is level. If needed, level the cabinet as directed on page #.

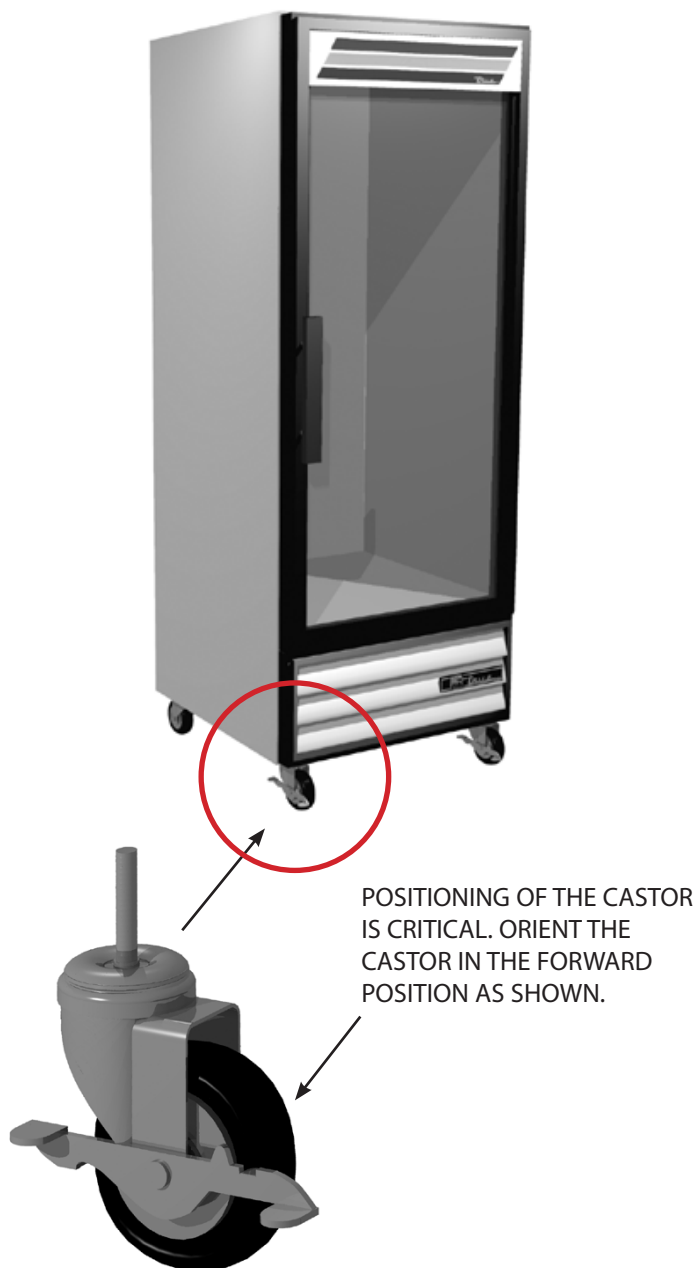



## Installation (cont.)

### Leveling

Proper leveling of your TRUE cooler is critical to operating success (for non-mobile models). Leveling impacts effective condensate removal and door operation.

Level the unit front-to-back and side-to-side.

1. Position the level on the inside floor of the unit near the doors (the level should be parallel to cabinet front). Level the cabinet.
2. Position the level at the inside rear of cabinet (again, the level should be placed parallel to cabinet back). Level the cabinet.
3. Perform procedures similar to steps 1 and 2 by placing the level on inside floor (left and right side, parallel to the depth of the cooler). Level the cabinet.

**NOTE:** If the cabinet has a center leveling screw, castor, or leg, make sure it is adjusted properly so it makes full contact with the floor after the cabinet has been leveled.

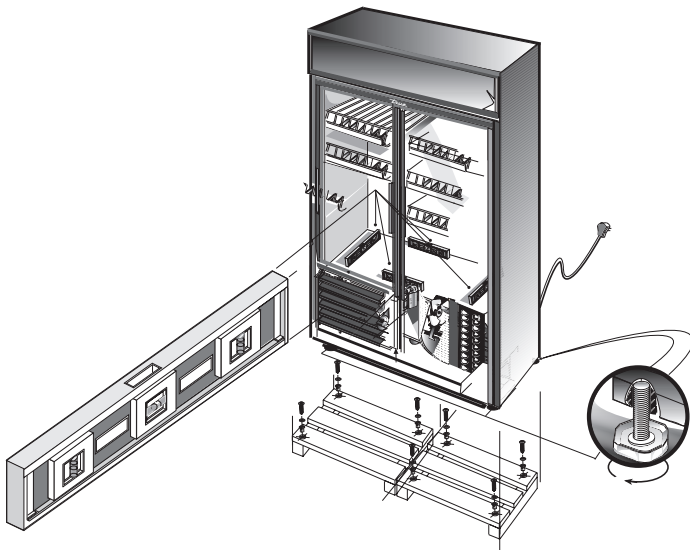
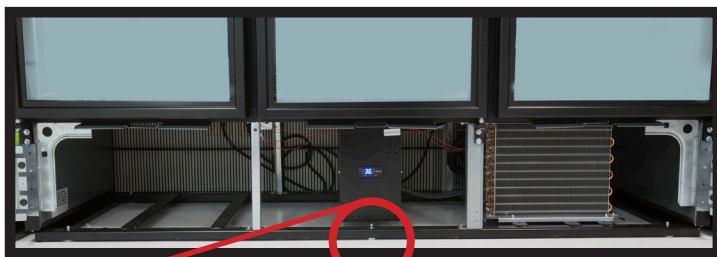

### Sealing the Cabinet to the Floor

Asphalt floors are susceptible to chemical attack. A layer of tape may be placed on the floor prior to applying the sealant to protect the floor.

1. Position the cabinet, allowing 3" (73 mm) between the wall and the rear of the cabinet to ensure proper ventilation.
2. Level the cabinet. The cabinet should be level side-to-side and front-to-back. To check that the cabinet is level, place a carpenter's level on the interior cabinet floor in four places:
  - a. Position the level on the inside floor of the cabinet, near the doors (the level should be placed parallel to the cabinet front). Level the cabinet.
  - b. Position the level at the inside rear of the cabinet (the level should be placed parallel to the cabinet back). Level the cabinet.
  - c. Perform procedures similar to a. and b. by placing the level on the left and right inside floor (level should be parallel to the cabinet sides). Level the cabinet.
3. Draw an outline of the cooler base on the floor.
4. Raise and block the front side of the cabinet.
5. Apply a bead of NSF-approved sealant (see list below) to the floor, 1/2" (13 mm) inside the front part of the outline drawn in step 4. The bead of sealant must be heavy enough to seal the entire cabinet surface when the cabinet is lowered on top of the sealant.
6. Raise and block the rear of the cabinet.
7. Apply sealant to the floor on the other three sides, as outlined in step 5.
8. Examine the cabinet to ensure that it is sealed to the floor around the entire perimeter.

### NSF-Approved Sealants

- 3M #ECU800 Caulk
- 3M #ECU2185 Caulk
- 3M #ECU1055 Bead
- 3M #ECU1202 Bead
- Armstrong Cork – Rubber Caulk
- Products Research Co. #5000 Rubber Caulk
- G.E. Silicone Sealer
- Dow Corning Silicone Sealer

# Installation (cont.)

## Electrical Installation & Safety

### Use of Adapter Plugs

**NEVER USE AN ADAPTER PLUG!** An adapter plug alters the original OEM plug configuration when connecting it to a power source.

TRUE will not warranty any refrigerator/freezer that has been connected to an adapter plug.

### Use of Extension Cords

**NEVER USE AN EXTENSION CORD!** An extension cord is determined to be any component that adds length to the original OEM power cord when connecting it to a power source.

TRUE will not warranty any refrigerator/freezer that has been connected to an extension cord.

### NEMA Plug Configurations

#### 60 HZ USE ONLY!

TRUE uses these types of NEMA plugs shown. If you **DO NOT** have the proper outlet, have a licensed electrician verify and install the correct power source.



### International (IEC) Plugs Only

International cabinets may be supplied with a power cord that will require installation. Install this cord before connecting the unit to a power source.

**NOTE:** International plug configurations will vary by country and voltage

### Installation

Fully seat the power cord into the cabinet receptacle until it locks in position. See fig. 1.

### Removal

Depress the red button. See fig. 2.

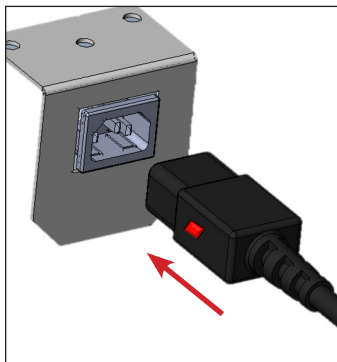

**Fig. 1.** Fully insert the power cord into the receptacle.

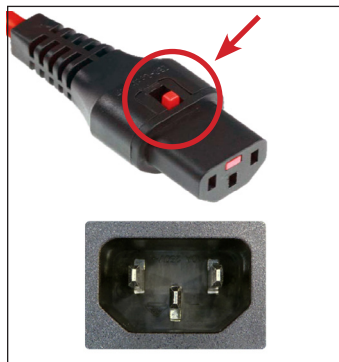

**Fig. 2.** Push the red button to remove the plug.

### How to Connect Electricity

- The power cord from this appliance is equipped with a grounding plug which minimizes the possibility of electric shock hazard.
- The wall outlet and circuit should be checked by a licensed electrician to make sure the outlet is properly grounded.
- If the outlet is a standard 2-prong outlet, it is your personal responsibility and obligation to have it replaced with the properly grounded wall outlet.
- **DO NOT**, under any circumstances, cut or remove the ground prong from the power cord. For personal safety, this appliance must be properly grounded.
- Before your new unit is connected to a power supply, check the incoming voltage with a voltmeter. If the recorded voltage is less than the rated voltage for operation (+/-5%) and amp rating, correct immediately. Refer to cabinet data plate for this voltage requirement.
- The refrigerator/freezer should always be plugged into a dedicated electrical circuit. This provides the best performance and prevents building wiring circuits from being overloaded, which could cause a fire hazard from overheated wires.
- Never unplug your refrigerator/freezer by pulling on the power cord. Always grip plug firmly and pull straight out from the outlet.
- When moving the refrigerator/freezer, for any reason, be careful not to roll over or damage the power cord.
- Repair or replace immediately all power cords that have become frayed or otherwise damaged. **DO NOT** use a power cord that shows cracks or abrasion damage along its length or at either end.
- If the supply power cord is damaged, it should be replaced with original equipment manufacturer (OEM) components. To avoid hazard this should be done by a licensed service provider.

### Cabinet Wiring Diagram

The cabinet's wiring diagram is in the exterior servicing compartment space of the cabinet.

A copy of the wiring diagram may also be obtained at [www.truemfg.com/support/serial-number-lookup](http://www.truemfg.com/support/serial-number-lookup)

# Cabinet Setup

## Standard Accessories

### Shelf Installation

1. Hook the shelf clips into the shelf standards. See fig. 1.
2. Push up on the bottom of the clip. See fig. 2.  
**NOTE:** You may need to squeeze or twist the bottom of the shelf clip for proper installation. Position all four shelf clips equal in distance from the floor for flat shelves. Lower the front of gravity-feed TrueTrac organizers for proper feed.
3. Ensure the shelf clip is not loose or able to wiggle out of the shelf standard. See figs. 3 and 4.
4. Place the shelves on the shelf clips with the cross support bars facing down.  
**NOTE:** Be sure all shelf corners are properly seated.

### Installation Tips

- Install **all** the shelf clips before installing any shelves.
- Start at the bottom shelf and work your way up.
- Always lay the back of each shelf down on the rear clips before the front.

**WARNING – DO NOT** use pliers or any crimping tools when installing shelf clips. Altering shelf clips in any way can lead to shelving instability.



### TrueTrac Organizers

TrueTrac organizers come with a package of shelf retainer clips. Install the clips on the side of the organizer towards the rear. See fig. 5.

### Shelf Adjustment

Shelving is adjustable for customer application. This cabinet meets the IEC Shelf Weight Capacity of 47lb/ft<sup>2</sup> (230kg/m<sup>2</sup>).



Fig. 1. Installing top tab of shelf clip.



Fig. 2. The bottom tab of the shelf clip will fit tightly



Fig. 3. You may need to squeeze or twist the bottom of the shelf clip to install.



Fig. 4. Installed shelf clip.

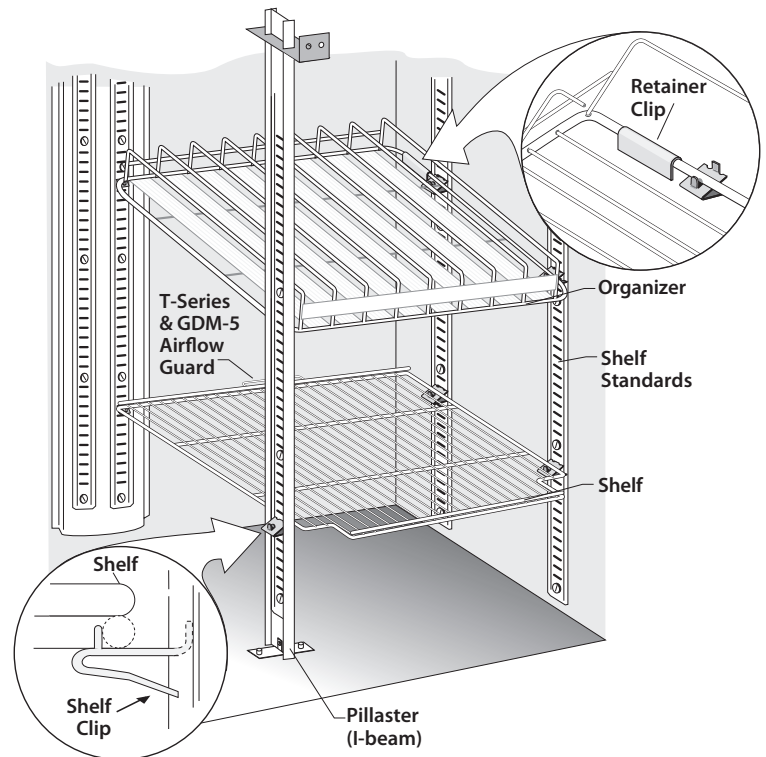
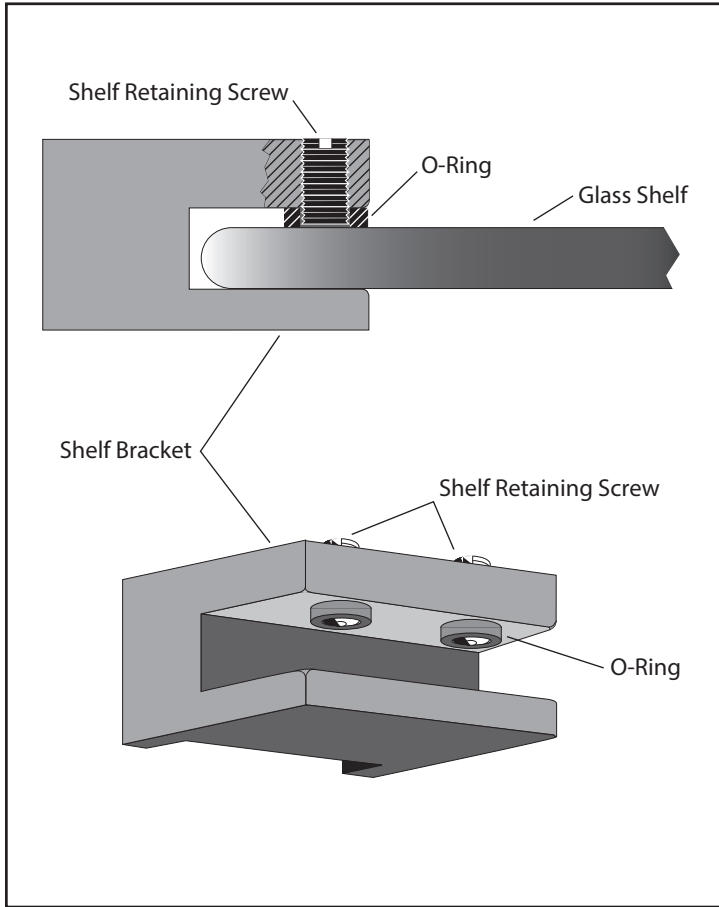

Fig. 5. GDM-5 models include an airflow guard on the rear shelves to maintain an air space at the rear of the cabinet.

## Cabinet Setup (cont.)

### G4SM-23RGS SHELF BRACKET ASSEMBLY



### Installing Shelves (GDM-30 only)

Tape door handles back to the cabinet when installing shelves



# Cabinet Operation

## Startup



- The compressor is ready to operate when the unit is purchased. All you need to do is plug in the cooler.
- Excessive tampering with the control could lead to service difficulties. If replacing the temperature control is ever needed, be sure to order the replacement from your TRUE dealer or recommended service agent.
- Good air flow inside your TRUE unit is critical. Take care to prevent product from pressing against the sides or back wall and coming within 4" (101.6 mm) of the evaporator housing. Refrigerated air off the evaporator coil must circulate throughout the cabinet for even product temperatures.

**NOTE:** If the unit is disconnected or shut off, wait 5 minutes before restarting.

**RECOMMENDATION** – Before loading product, run your TRUE unit empty for 24 hours to verify proper operation. Remember, our factory warranty **DOES NOT** cover product loss!

## Temperature Control & Light Switch Location

Light switch location varies by GDM model. Most models have the light switch located on the right side of the ceiling, next to the temperature control.

The light symbol  shows the approximate location of the light switch. 

The electronic temperature control can act as a light switch. To control the light, press the up arrow  **M**.



**Light Switch on Glass Door Models**  
Inside top right ceiling.



**Mechanical or Electronic Temperature Control w/o Digital Display**  
Inside top right ceiling or back wall.

**Electronic Temperature Control with Digital Display**  
Behind the front bottom louvered grill.



### FOR MORE INFORMATION

For more information regarding a cabinet's temperature control adjustment or general sequence of operation, please see our **Temperature Control Adjustment—Sequence of Operation Manual** in our resource library at <https://www.truemfg.com/Service-Manuals/Sequence-of-Operation> or follow the QR code.



## Cabinet Operation (cont.)

### General Sequence of Operation—Refrigerator and Freezer Cabinets

#### When the cabinet is plugged in

- Interior lights will illuminate on glass door models (see previous page for light switch location).
- An electronic control with digital display will illuminate (if installed).
- There may be a short delay before the compressor and/or evaporator fan(s) start. This delay may be determined by time or by temperature, which could be the result of an initial defrost event that will last at least 6 minutes.
- The temperature control/thermostat may cycle the compressor and evaporator fan(s) on and off together. Every cabinet will require a defrost event to ensure the evaporator coil remains clear of frost and ice buildup. Defrost is initiated by a defrost timer or by the electronic control.

**EXCEPTION** – Models TSID, TDBD, TCGG, and TMW do not have an evaporator fan(s).

- The temperature control/thermostat senses either an evaporator coil temperature or air temperature, NOT product temperature.
- An analog thermometer, digital thermometer, or electronic control display may reflect the refrigeration cycle swings of up and down temperatures, NOT product temperature. **The most accurate method to determine a cabinet's operation is to verify the product temperature.**
- Refrigerators with mechanical temperature controls will defrost during every compressor off-cycle.
- Freezers with mechanical temperature controls will defrost by time initiation as determined by a defrost timer.

**EXCEPTION** – Models TFM, TDC, THDC and TMW require a manual defrost. The frequency of this manual defrost will depend on the cabinet's usage and ambient conditions.

- An electronic control with a digital display (if installed) will show **def** during defrost.

**NOTE:** The display may have a short delay before showing a temperature after a defrost event has expired and instead show **def** during a refrigeration cycle.

- Models with an analog or digital thermometer may show higher than normal temperatures during defrost.
- A refrigerator will use the evaporator fans to clear the coil during defrost.

**EXCEPTION** – Models TSID, TDBD, and TCGG do not have an evaporator fan(s).

- A freezer will use heaters to clear the evaporator coil during defrost.

**NOTE:** The evaporator coil heater and drain tube heater are only energized during defrost. Defrost is terminated when a specific evaporator coil temperature is reached or by a time duration.

# Maintenance, Care & Cleaning

**CAUTION** - Take care during operation, maintenance or repairs to avoid cuts or pinching from any cabinet part/component.

## Condenser Coil Cleaning

When using electrical appliances, basic safety precautions should be followed, including the following:



**WARNING** – **DO NOT** clean appliance with a pressure washer or hose.



**CAUTION** – Fins are sharp. Caution must be used to avoid eye injury. Eye protection is recommended.

### Tools Required

- 1/4" nut driver
- 3/8" nut driver
- Stiff bristle brush
- Tank of compressed air
- Vacuum cleaner
- Flashlight
- Eye protection

1. Disconnect power to unit.
2. Remove the front louvered grill from the cabinet. See fig. 1-3.
3. Carefully clean off accumulated dirt from the front fins of the condensing coil with a stiff bristle brush. See fig. 3.
4. With dirt removed from the surface of the coil, use a flashlight to verify that you can see through the coil and observe the condenser fan blade spinning. See fig. 4.

If the view is clear, reinstall louvered grill, connect unit to power and verify operation.

**If the view is still blocked with dirt, proceed to step 6.**

5. Remove the condenser base bolts. See fig. 6.
6. Remove the condenser coil brackets.
7. Carefully slide the condensing unit out (tubing connections are flexible). Gently blow compressed air or CO<sub>2</sub> through the coil until it is clean.
8. Carefully vacuum any dirt around and behind the condensing unit area.
9. Replace the coil brackets. Then carefully slide the compressor assembly back into position and replace the bolts.
10. Reinstall the louvered grill, connect power to the unit, and verify operation.

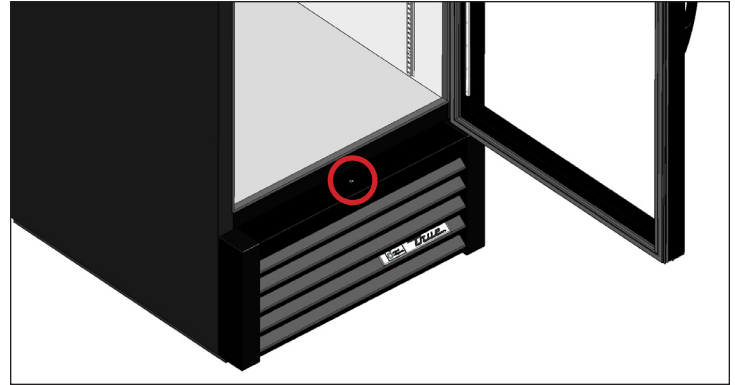

Fig. 1. Swing door louver grill screw location.



Fig. 2. Slide door louver grill screw locations.

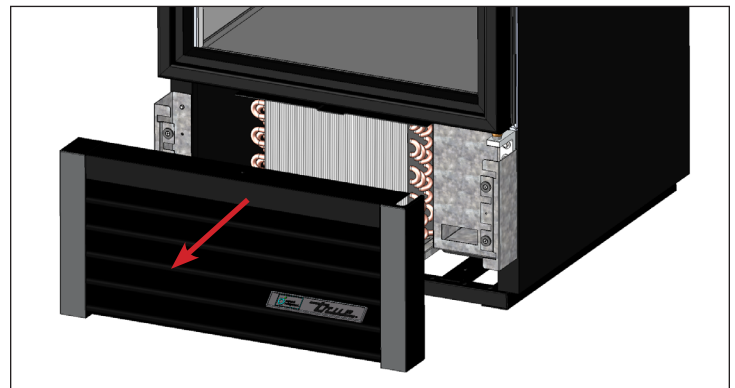

Fig. 3. Carefully remove the grill.

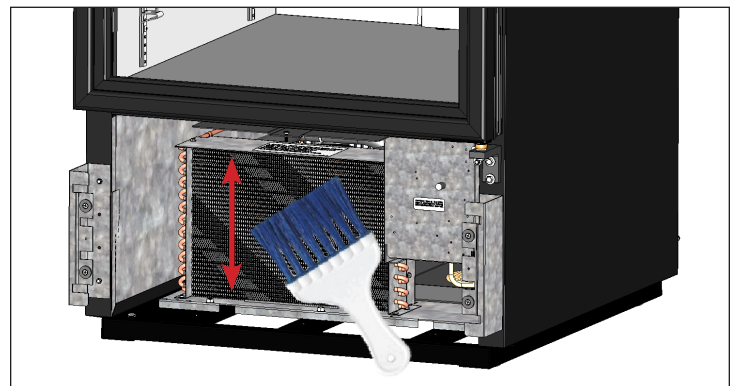
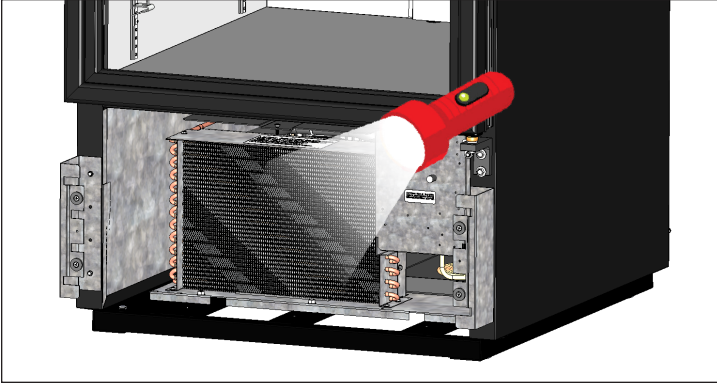
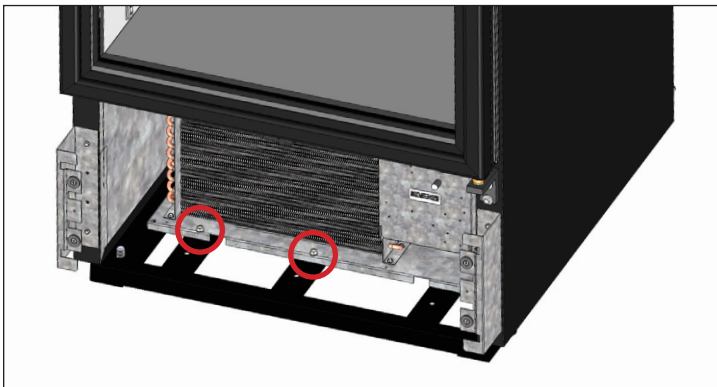

Fig. 4. Never brush across the coil fins.

## Maintenance, Care & Cleaning (cont.)



**Fig. 5.** Verify all blockages have been removed.



**Fig. 6.** Remove condenser base bolts.

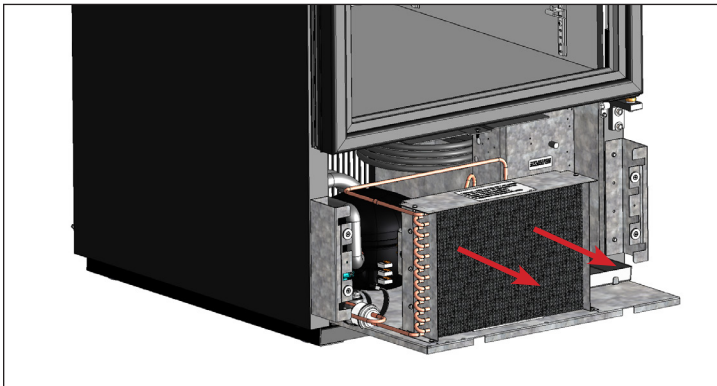

**Fig. 7.** Carefully slide the condensing unit out.

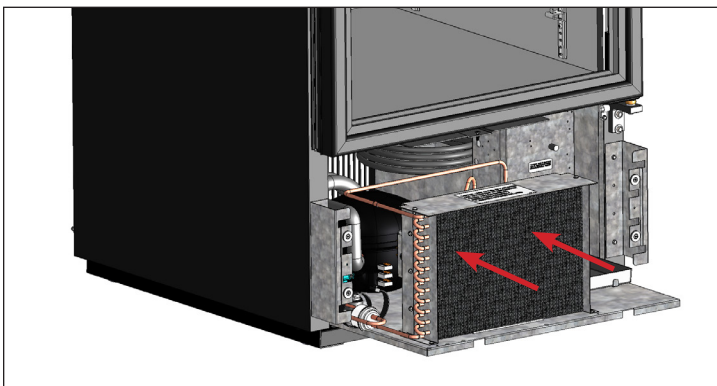

**Fig. 8.** Carefully slide the condensing unit back into position and replace the bolts.



### Important Warranty Information

**THE CLEANING OF THE CONDENSER IS NOT COVERED BY WARRANTY!**

If you have any questions, please contact your local TRUE Manufacturing Service Department. See the front cover for locations and contact information.

- Condenser coils accumulate dirt and require cleaning every 30 days or as needed.
- A dirty condenser coil can result in non-warranted repairs and/or cabinet failure.
- Proper cleaning involves removing dust from the condenser by using a soft brush, vacuuming the condenser with a shop vac, or using CO<sub>2</sub>, nitrogen or pressurized air.
- Do not place any filter material in front of the condensing coil.
- On most units, the condenser is accessible by removing the cabinet's outer grill cover.
- If you cannot remove the dirt adequately, please contact your licensed refrigeration service provider.



## Maintenance, Care & Cleaning (cont.)

### Stainless Steel Care & Cleaning

**CAUTION** – **DO NOT** use any steel wool, abrasive or chlorine-based products to clean stainless steel surfaces.

#### Stainless Steel Opponents

There are three basic things which can break down your stainless steel's passivity layer and allow corrosion to form.

- Scratches from wire brushes, scrapers, steel pads, and other items that can be abrasive to stainless steel's surface.
- Deposits left on your stainless steel can leave spots. You may have hard or soft water depending on what part of the country you live in. Hard water can leave spots. Hard water that is heated can leave deposits if left to sit too long. These deposits can cause the passive layer to break down and rust your stainless steel. All deposits left from food prep or service should be removed as soon as possible.
- Chlorides which are present in table salt, food and water, as well as in household and industrial cleaners. These are the worst type of chlorides to use on stainless steel.

#### Stainless Steel Cleaning and Restoration

**DO NOT** use stainless steel cleaners or similar solvents to clean plastic or powder-coated parts. Instead, use warm soapy water.

- For routine cleaning and removal of grease and oil, apply white vinegar, ammonia, or any good commercial detergent\* with a soft cloth or sponge.
  - Stainless steel polish (e.g., Zep® Stainless Steel Polish, Weiman® Stainless Steel Cleaner & Polish, Nyco® Stainless Steel Cleaner & Polish, or Ecolab® Ecoshine®) and olive oil can act as a barrier against fingerprints and smears.
  - Degreasers\* (e.g., Easy-Off® Specialty Kitchen Degreaser or Simple Green® Industrial Cleaner & Degreaser) are excellent for removal of grease, fatty acids, blood and burnt-on foods on all surfaces.
- \***DO NOT** use detergents or degreasers with chlorides or phosphates.
- For restoration/passivation or removing stubborn stains and discoloration, Brillo® Cameo®, Zud® Cleanser, Ecolab® Specifax™ First Impression® Metal Polish, Sheila Shine, or talc can be applied by rubbing in the direction of the polish lines.

**NOTE:** The use of proprietary names is intended for example only and does not constitute or imply an endorsement. Omission of proprietary cleansers from this list does not imply inadequacy.

### 8 Tips to Help Prevent Rust on Stainless Steel

#### Maintain the Cleanliness of Your Equipment

Avoid build-up of hard stains by cleaning frequently. Use cleaners at the recommended strength (alkaline chlorinated or non-chloride).

#### Use the Correct Cleaning Tools

Use non-abrasive tools when cleaning your stainless steel products. The stainless steel's passive layer will not be harmed by soft cloths and plastic scouring pads.

#### Clean Along Polishing Lines

Polishing lines ("grain") are visible on some stainless steels. Always scrub parallel to polishing lines when visible. Use a plastic scouring pad or soft cloth when you cannot see the grain.

#### Use Alkaline, Alkaline-Chlorinated or Non-Chloride Cleaners

While many traditional cleaners are loaded with chlorides, the industry is providing an ever increasing choice of non-chloride cleaners. If you are not sure of your cleaner's chloride content, contact your cleaner supplier. If they tell you that your present cleaner contains chlorides, ask if they have an alternative. Avoid cleaners containing quaternary salts, as they can attack stainless steel, causing pitting and rusting.

#### Rinse

When using chlorinated cleaners, you must rinse and wipe dry immediately. It is better to wipe standing cleaning agents and water as soon as possible. Allow the stainless steel equipment to air dry. Oxygen helps maintain the passivity film on stainless steel.

#### Never Use Hydrochloric Acid (Muriatic Acid) on Stainless Steel

Even diluted, hydrochloric acid can cause corrosion, pitting and stress corrosion cracking of stainless steel.

#### Water Treatment

To reduce deposits, soften hard water when possible. Installation of certain filters can remove corrosive and distasteful elements. Salts in a properly maintained water softener can also be to your advantage. Contact a treatment specialist if you are not sure of the proper water treatment.

#### Regularly Restore & Passivate Stainless Steel

Stainless steel gets its stainless properties from the protective chromium oxides on its surface. If these oxides are removed by scouring, or by reaction with harmful chemicals, then the iron in the steel is exposed and can begin to oxidize, or rust. Passivation is a chemical process that removes free iron and other contaminants from the surface of stainless steel, allowing the protective chromium oxides to re-form.

## Cabinet Adjustments, Servicing, & Component Replacement

**NOTE:** Any cabinet adjustments are to be made **AFTER** the cabinet has been verified level and properly supported.

### Servicing & Replacing Components

- Replace component parts with OEM (original equipment manufacturer) components.
- Have a licensed service provider service your unit to minimize the risk of possible ignition due to incorrect parts or improper service and to ensure the operator's health and safety.
- Unplug the refrigerator/freezer before cleaning or making any repairs. Setting temperature controls to the 0 position or powering off an electronic control may not remove power from all components (e.g., light circuits, perimeter heaters, and evaporator fans).

### Slide Door Operation – Door Removal

**DO NOT** use the side latch before removing the slide door. The tension on the door cord is needed to execute these operation instructions. Doors cannot be removed unless they are positioned as stated in these instructions.

1. Position the doors as described below:

#### *Two-Door Units*

Slide the front door so it is centered on the cabinet. See figs. 1 and 2.

#### *Three-Door Units*

Center the middle door on the left edge of the right door. See fig. 3.

2. After centering, lift the door and tilt the top of the door back until the rollers are out of the top channel. Then, swing the bottom of the door out of the bottom channel. See fig. 4.

#### **Two-Door units skip to step 5**

3. Slide the right door to the left and align the left edge with the beginning of the TRUE Logo at the top of the door frame (see fig. 5). Then lift the door out of the track as described in step 2 (see fig. 4).
4. Slide the left door to the right and align the right edge with the end of the TRUE Logo at the top of the door frame (see fig. 6). Then lift door out of track same way as fig. 4.
5. Remove the door cord from the roller bracket. See figs. 7 and 8.
 

**NOTE:** The door cord will either be nylon cord or metal cable. The black plastic tab holding the door cord slides out the back.
6. Let the door cord slowly retract back into the door side channel.
7. When reinstalling the door, be sure the door cord grommet attaches to roller slot closest to the pulley. See fig. 9

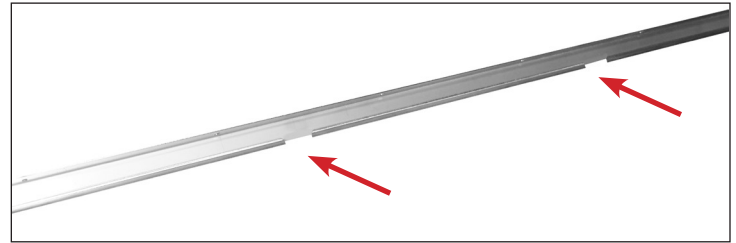

**Fig. 1.** Door channel openings (two-door units ONLY).



**Fig. 2.** Two-Door Units: Position the front door at the center of the cabinet.



**Fig. 3.** Three-Door Units: Center the middle door on the left edge of the right door.

# Cabinet Adjustments, Servicing & Component Replacement (cont.)



Fig. 4. Carefully remove the door.

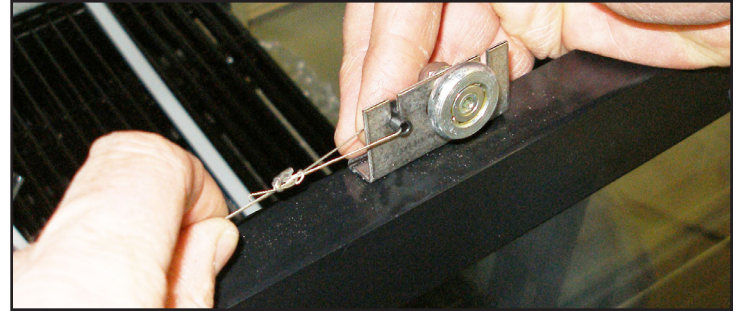

Fig. 7. Remove the door cord from the roller bracket.



Fig. 8. Slide the black tab holding the door cord out the back

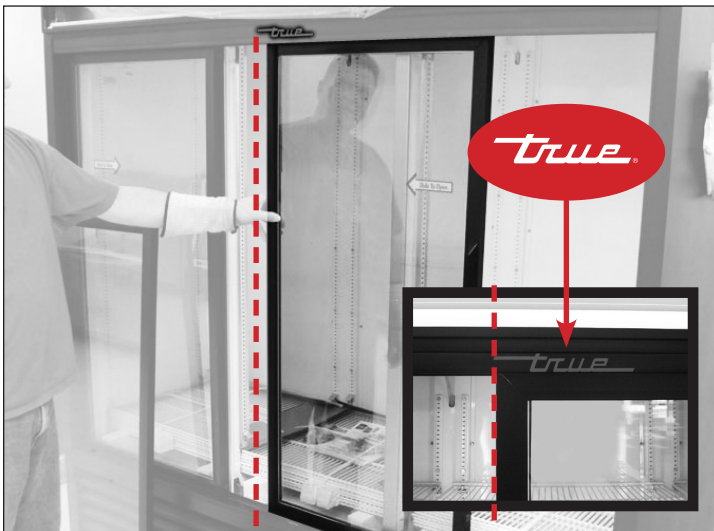

Fig. 5. Align the left edge of the right door with the left edge of the True logo.

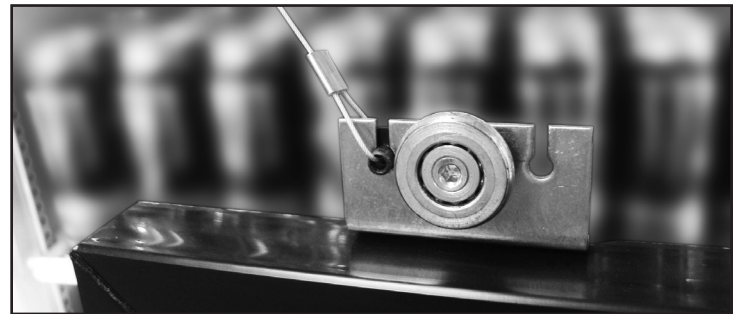

Fig. 9. Be sure the door cord is in the roller slot closest to the pulley.



Fig. 6. Align the right edge of the left door with the right edge of the TRUE logo.

## Cabinet Adjustments, Servicing & Component Replacement (cont.)

### Slide Door Operation – Door Adjustment

Only adjust the cabinet after it has been installed in its final location and correctly leveled.

1. Completely close the slide doors and check for openings. If there are any gaps/openings between the closed doors and cabinet, the doors will need to be adjusted.
2. With a 7/16" wrench or adjustable wrench and 1/8" Allen wrench, loosen the roller and move it along the slotted hole. After the adjustment has been made tighten the roller into place. See fig. 1.

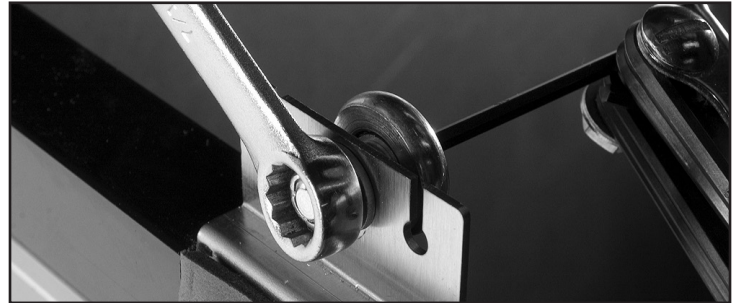

**Fig. 1.** Adjust the roller.

### Slide Door Operation – Hold-Open Feature

The hold-open feature keeps the door in the open position.

1. Slide the door open.
2. Latch the door in the open position from the back side of door (notch in track). See figs. 1 and 2.

**NOTE:** Figs. 1 and 2 show the rear view of the door and track.



**Fig. 1.** Door latch is in the open position (engaged with notch).



**Fig. 2.** Door latch is in the closed position (disengaged from notch).

#### FOR MORE INFORMATION

For additional maintenance instruction, please visit the media center at

[www.truemfg.com](http://www.truemfg.com)

## Warranty Information (USA & Canada Only)



### Three-Year Parts & Labor Warranty

TRUE warrants to the original purchaser of every new TRUE refrigerated unit, the cabinet and all parts thereof, to be free from defects in material or workmanship, under normal and proper use and maintenance service as specified by TRUE and upon proper installation and start-up in accordance with the instruction packet supplied with each TRUE unit. TRUE's obligation under this warranty is limited to a period of three (3) years from the date of original installation or 39 months after shipment date from TRUE, whichever occurs first.

Any part covered under this warranty that is determined by TRUE to have been defective within three (3) years of original installation or thirty-nine (39) months after shipment date from manufacturer, whichever occurs first, is limited to the repair or replacement, including labor charges, of defective parts or assemblies. The labor warranty shall include standard straight time labor charges only and reasonable travel time, as determined by TRUE.

Warranty does not cover standard wear parts which include door gaskets, incandescent bulbs or fluorescent bulbs. Warranty also does not cover issues caused by improper installation or lack of basic preventative maintenance, which includes regular cleaning of condenser coils.

### Additional Two-Year HFC Compressor Warranty & Additional Four-Year Hydrocarbon Compressor Warranty

In addition to the three (3) year warranty stated above, TRUE warrants its hermetically and semi-hermetically sealed HFC compressor to be free from defects in both material and workmanship under normal and proper use and maintenance service for a period of two (2) additional years and for Hydrocarbon Units, an additional four (4) years from the date of original installation but not to exceed five (5) years and three (3) months for HFC compressors and not to exceed seven (7) years and three (3) months for HC compressors after shipment from the manufacturer.

Compressors determined by TRUE to have been defective within this extended time period will, at TRUE's option, be either repaired or replaced with a compressor or compressor parts of similar design and capacity.

The two (2) year extended HFC or four (4) year HC extended compressor warranty applies only to hermetically and semi-hermetically sealed parts of the compressor and does not apply to any other parts or components, including, but not limited to: cabinet, paint finish, temperature control, refrigerant, metering device, driers, motor starting equipment, fan assembly or any other electrical component, etcetera.

### 404a/134a/Hydrocarbon Compressor Warranty

The two (2) year HFC compressor and four (4) year HC compressor warranty detailed above will be voided if the following procedure is not carefully adhered to:

1. This system contains R404A, R134A, or R290 refrigerant and polyol ester lubricant. The polyol ester lubricant has rapid moisture absorbing qualities. If long exposure to the ambient conditions occur, the lubricant must be removed and replaced with new. For oil amounts and specifications please call TRUE Technical Service Department (855-372-1368). Failure to comply with recommended lubricant specification will void the compressor warranty.
2. Drier replacement is very important and must be changed when a system is opened for servicing. An OEM exact replacement should be used. The new drier must also be the same capacity as the drier being replaced.
3. Micron level vacuums must be achieved to ensure low moisture levels in the system. 500 microns or lower must be obtained.

### Warranty Claims

All claims for labor or parts must be made directly through TRUE. All claims should include: model number of the unit, the serial number of the cabinet, proof of purchase, date of installation, and all pertinent information supporting the existence of the alleged defect.

In case of warranty compressor, a picture of the compressor model tag must be returned to TRUE along with above listed information. For warranty claim information, visit: [www.truemfg.com/support/warranty-support](http://www.truemfg.com/support/warranty-support). Any action for breach of these warranty provisions must be commenced within six (6) months of the defect giving rise to the breach.

TRUE reserves the right to request any failed part covered under warranty to be returned.

### What is NOT Covered by this Warranty

TRUE's sole obligation under this warranty is limited to either repair or replacement of parts, subject to the additional limitations below. This warranty neither assumes nor authorizes any person to assume obligations other than those expressly covered by this warranty.

**No Consequential Damages.** TRUE is not responsible for economic loss; profit loss; or special, indirect, or consequential damages, including without limitation, losses or damages arising from food or product spoilage claims whether or not on account of refrigeration failure.

**Warranty is NOT Transferable.** This warranty is not assignable and applies only in favor of the original purchaser/user to whom delivered. Any such assignment or transfer shall void the warranties herein made and shall void all warranties, express or implied, including any warranty of merchantability or fitness for a particular purpose.

**Improper Usage.** TRUE assumes no liability for parts or labor coverage for component failure or other damages resulting from improper usage or installation or failure to clean and/or maintain product as set forth in the warranty packet provided with the unit.

**Relocation of Cabinet for Repair.** TRUE is not responsible for the cost to move a cabinet for any reason from its position of operation on the customer's premises to make a warranty repair.

**Non OEM Parts.** Use of non OEM parts without manufacturer's approval will void cabinet warranty.

**Alteration, Neglect, Abuse, Misuse, Accident, Damage During Transit or Installation, Fire, Flood, Acts of God.** TRUE is not responsible for the repair or replacement of any parts that TRUE determines have been subjected after the date of manufacture to alteration, neglect, abuse, misuse, accident, damage during transit or installation, fire, flood, or act of god.

**Improper Electrical Connections.** TRUE is not responsible for the repair or replacement of failed or damaged components resulting from incorrect supply voltage, the use of extension cords, low voltage, or unstable supply voltage.

**No Implied Warranty of Merchantability or Fitness for a Particular Purpose.** There are no other warranties, expressed, implied or statutory, except the three (3) year parts & labor warranty and the additional two (2) year HFC compressor and the additional four (4) year HC compressor warranty as described above. These warranties are exclusive and in lieu of all other warranties, including implied warranty and merchantability or fitness for a particular purpose. There are no warranties which extend beyond the description on the face hereof.

**Outside USA & Canada.** This warranty does not apply to, and TRUE is not responsible for, any warranty claims made on products sold or used outside the United States and Canada. This warranty only applies to units shipped from TRUE's manufacturing facilities after October 1, 2019 for USA Foodservice & Retail and after July 1, 2020 for Canada.

### Environmental Attributes

Any and all environmental attributes, including environmental offset credit rights, with respect to TRUE® Refrigeration units manufactured after September 1, 2015, shall remain the property of TRUE Manufacturing Co., Inc. and are not transferred.

**This warranty only applies to units installed after January 1, 2020 for USA Foodservice & Retail and after July 1, 2020 for Canada.**

BP\_03.2021

*truwe*®

[www.truemfg.com](http://www.truemfg.com)