



INSTRUCTIONS FOR USE

ADJUSTABLE POLYMER "POKER CHIP" DISH DOLLY



Model No PCD11A

COMPONENTS

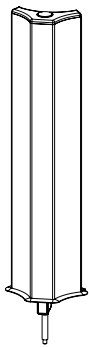

Divider
(x4)



Bracket
(x4)



Cover
(x1)



Knob
(x4)

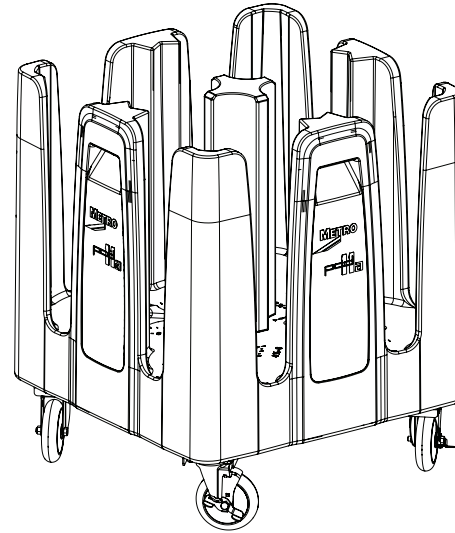

Dolly with
Tower
(x1)

NOTE: Accessory Divider Kit
(4 additional dividers, Brackets & Knobs)

ASSEMBLY STEPS

- 1** Unpack cartons to confirm amount and identity of components.
- 2** Identify the dish/plate sizes to be held in the unit. Located on the base of the dolly are a series of numbers which represent the approximate dish/plate diameters. By using these numbers and the indicators on both the dividers and tower, a wide range of dishes/plates can be accommodated. Refer to the Divider and Tower Configurations page of this manual for various configurations.

3 FOR DISHES/PLATES 5½" (140mm) OR GREATER

Lay the dolly on its side to expose the underside of the base. Loosen the tower knob approximately ½ inch (1 cm). Do not remove the knob (Fig 1). From the top side, pull the tower away from the base and rotate until the tower indicator is aligned with the desired size on the base (Fig. 2). Tighten tower knob. In some applications, the tower may be removed completely.

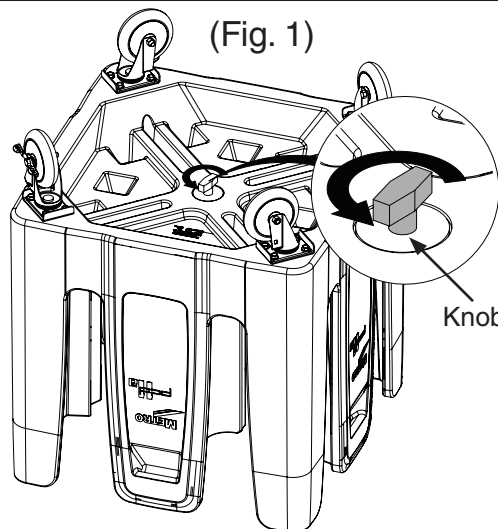

(Fig. 1)

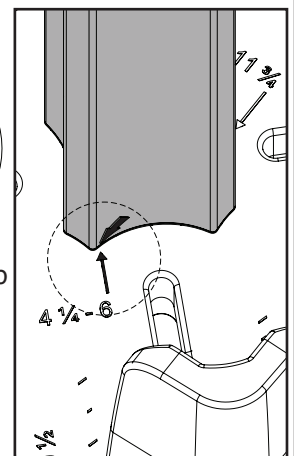

(Fig. 2)

- 4** Next, install a divider by using the indicator and numbers, inserting the threaded rod thru the base slot (Fig. 3 & 4). Install bracket and knob. Do not tighten (Fig. 5).

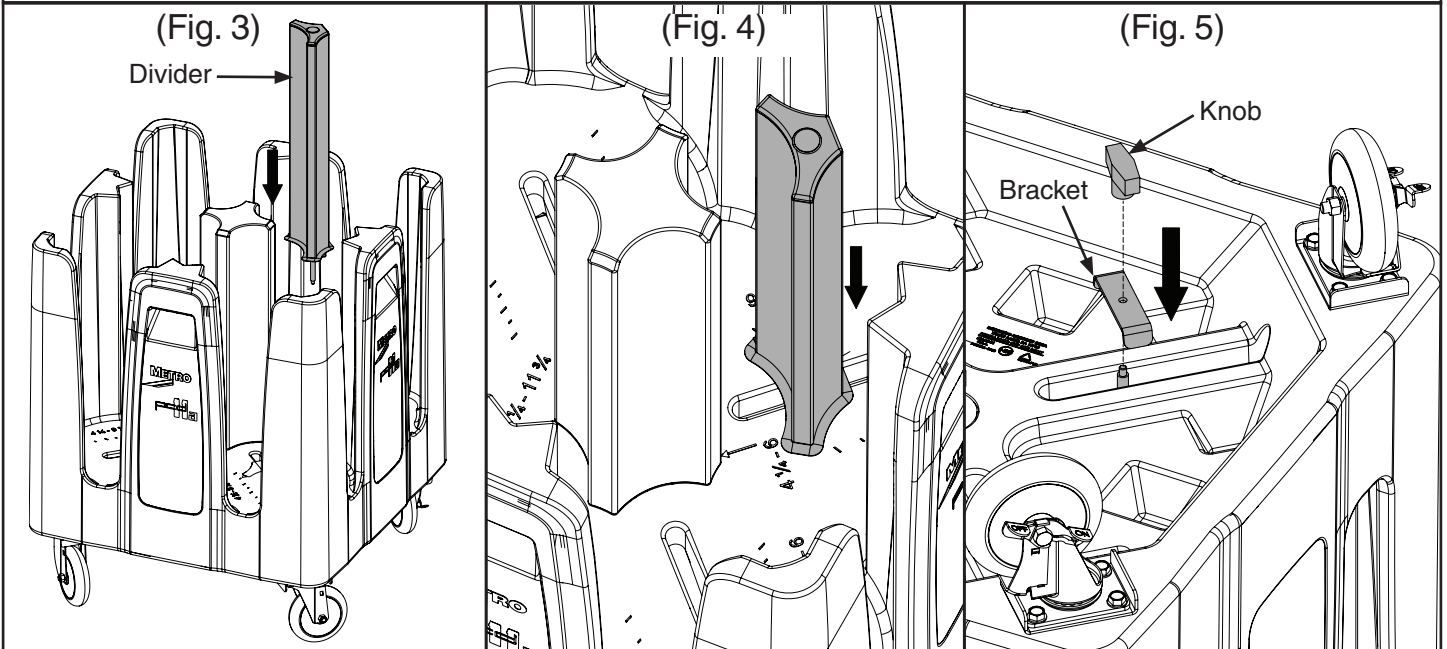

- 5** Repeat for the other 3 bays and stand the unit back on the casters.

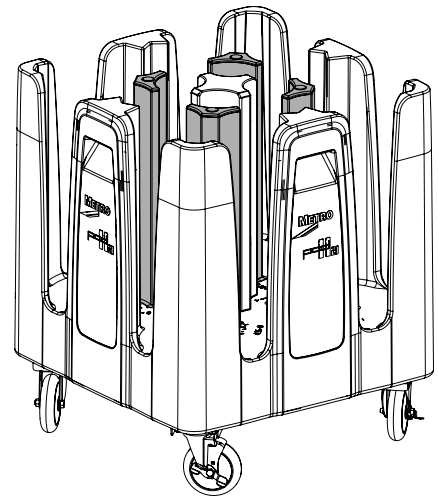

- 6** Using a dish/plate as a guide, make the final divider adjustments and tighten all knobs

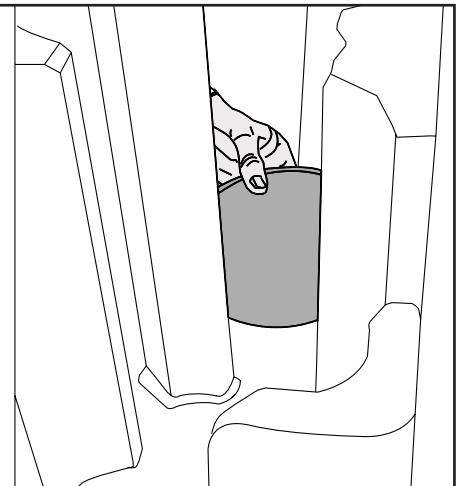

7 FOR DISHES/PLATES UNDER 5½" (140mm)

An Accessory Divider Kit (4 additional dividers) must be used when holding dishes or plates under 5½" (140mm) in diameter. (more details on page #5)

Refer to steps #4 thru #6 for installation of the additional dividers.

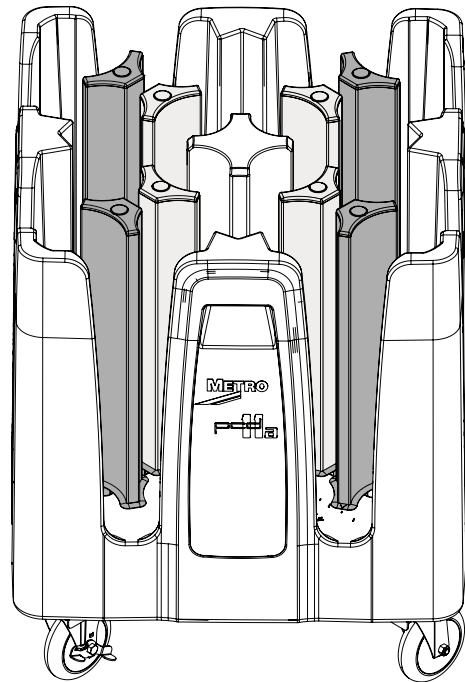

CLEANING AND MAINTENANCE

⚠ CAUTION **Never** use abrasive detergents or scouring powders on polymer surfaces.

This product is manufactured from polymers which offers resistance to soil and long service if properly maintained. Most spills can be cleaned with a damp cloth or a water rinse, however, stubborn soils will require the use of commercial cleaning products.

In all cases, regular cleaning and thorough rinsing will extend the service life and maintain the product appearance.

HAND CLEANING OPERATIONS

A mild detergent applied with a cloth or sponge will effectively deal with normal accumulations of soil.

1. Prepare cleaning solutions according to instructions provided by the detergent manufacturer.
2. Wash surfaces with a wet applicator and thoroughly rinse from top to bottom.
3. Wipe dry to minimize spotting.

Multi-purpose foam cleaners are available which provide both cleaning and disinfecting capability. Consult product label for specific information regarding use.

REMOVAL OF HEAVY SOIL OR STAINS

Use of an all-purpose cleaner along with a soft brush will remove heavy soil and caked-on foods.

1. Saturate the affected area with cleanser and brush in a circular motion.
2. Rinse thoroughly and repeat if necessary.

DIVIDER AND TOWER CONFIGURATIONS

STANDARD MODEL

For Dishes/Plates 5½" to 11¾"
(140 to 300mm) Diameter.

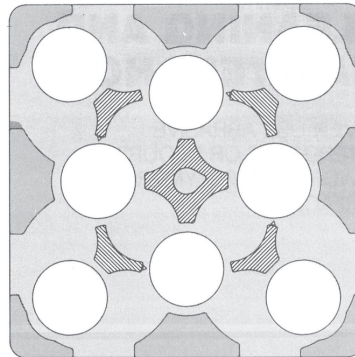

**5½" TO 6¾" (140 to 160mm)
DISH/PLATE DIAMETER
8 COLUMNS**

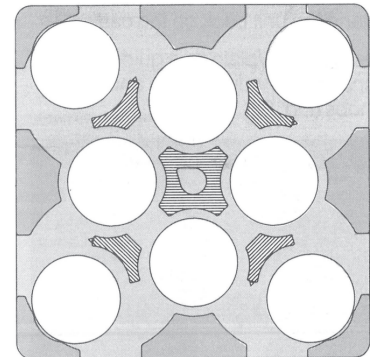

**6½" TO 7¾" (165 to 185mm)
DISH/PLATE DIAMETER
8 COLUMNS**

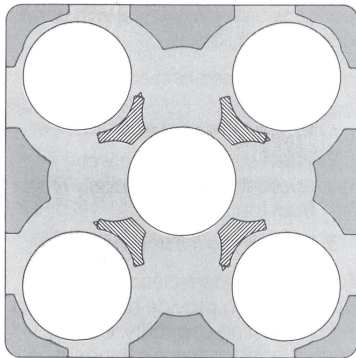

**7½" TO 8½" (190 to 215mm)
DISH/PLATE DIAMETER
5 COLUMNS - TOWER
REMOVED**

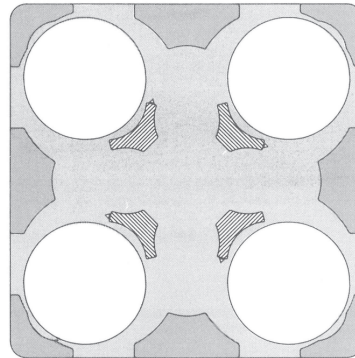

**8¾" TO 9½" (220 to 240mm)
DISH/PLATE DIAMETER
4 COLUMNS - TOWER
REMOVED**

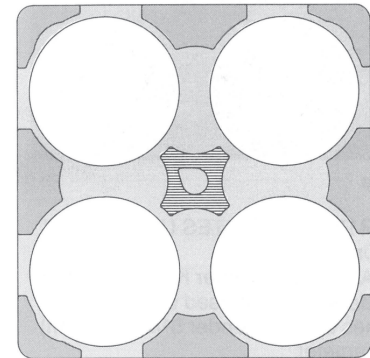

**9¾" TO 11¾" (245 to 300mm)
DISH/PLATE DIAMETER
4 COLUMNS - DIVIDERS
REMOVED**

STANDARD MODEL

With Accessory Divider Kit
(4 additional dividers) for
Dishes/Plates 4½" to 5¾"
(108 to 135mm) Diameter.

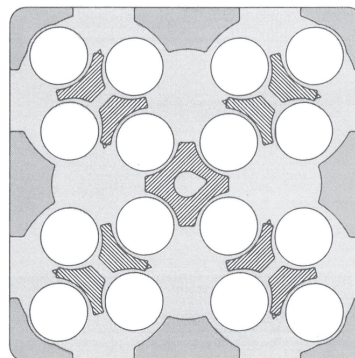

**4¼" TO 4¾" (108 to 115mm)
DISH/PLATE DIAMETER
16 COLUMNS**

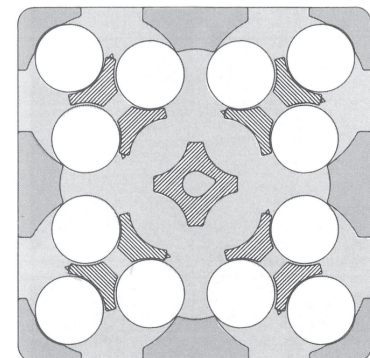

**4¾" TO 5¾" (120 to 135mm)
DISH/PLATE DIAMETER
12 COLUMNS**

THIS PAGE IS KEPT INTENTIONALLY BLANK

THIS PAGE IS KEPT INTENTIONALLY BLANK

* Save this document for future application, load rating and/or safety reference.

© 2021 InterMetro Industries Corporation, Wilkes-Barre, PA 18705
L01-122 REV A 03/21



We put space to work.

an Ali Group Company



The Spirit of Excellence