

Specification Line® GA Series

Original Instructions Service Manual

This manual is updated as new information and models are released. Visit our website for the latest manual.

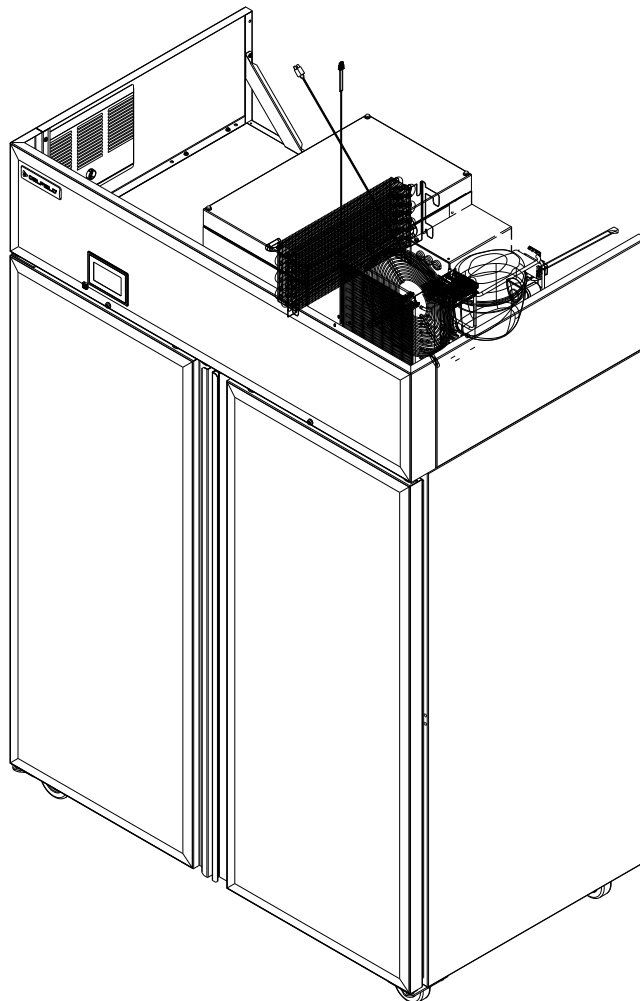

Safety Notices

⚠ Warning

Read this manual thoroughly before operating, installing or performing maintenance on the equipment. Failure to follow instructions in this manual can cause property damage, injury or death.

⚠ DANGER

Do not install or operate equipment that has been misused, abused, neglected, damaged, or altered/modified from that of original manufactured specifications.

⚠ DANGER

Use appropriate safety equipment during installation and servicing.

⚠ DANGER

All utility connections and fixtures must be maintained in accordance with Local and national codes.

⚠ Warning

Do not damage the refrigeration circuit when installing, maintaining or servicing the unit.

⚠ Warning

Authorized Service Representatives are obligated to follow industry standard safety procedures, including, but not limited to, local/national regulations for disconnection / lock out / tag out procedures for all utilities including electric, gas, water and steam.

⚠ Warning

Do not store or use gasoline or other flammable vapors or liquids in the vicinity of this or any other appliance. Never use flammable oil soaked cloths or combustible cleaning solutions, for cleaning.

⚠ Warning

This product contains chemicals known to the State of California to cause cancer and/or birth defects or other reproductive harm. Operation, installation, and servicing of this product could expose you to airborne particles of glasswool or ceramic fibers, crystalline silica, and/or carbon monoxide. Inhalation of airborne particles of glasswool or ceramic fibers is known to the State of California to cause cancer. Inhalation of carbon monoxide is known to the State of California to cause birth defects or other reproductive harm.

⚠ Warning

Do not use electrical appliances inside the food storage compartments of the appliance, unless they are of the type recommended by the manufacturer.

⚠ Warning

Use caution when handling metal surface edges of all equipment.

⚠ Warning

This appliance is not intended for use by persons (including children) with reduced physical, sensory or mental capabilities, or lack of experience and knowledge, unless they have been given supervision concerning use of the appliance by a person responsible for their safety. Do not allow children to play with this appliance.

⚠ Caution

Use caution handling, moving and use of the R290 refrigerators to avoid either damaging the refrigerant tubing or increasing the risk of a leak. Components shall be replaced with like components. Servicing shall be done by a factory authorized service personnel to minimize the risk of possible ignition due to incorrect parts or improper service.

Notice

Proper installation, care and maintenance are essential for maximum performance and trouble-free operation of your equipment. Visit our website www.wbtkitchen.com for manual updates, translations, or contact information for service agents in your area.

Notice

Warranty may be deemed invalid if other than authorized OEM (original equipment manufacture) replacement parts are used in Delfield equipment.

Table of Contents

Section 1

General Information

Model Numbers	5
Serial Number Information	5
Warranty Information	5
Regulatory Certifications	5

Section 2

Installation

Location	7
Clearance Requirements	7
Drain Connections	7
Floor Drain Required	7
Weight, Capacity & Dimensions of Equipment	8
Electrical Service	9
Ground Fault Circuit Interrupter	9
Electrical Specification Chart	9
Energy Use	10
Leg & Caster Installation	11
Level & Stable	12
Shelf Installation	12
Reversible Door Instructions	12
Applicable to Full Door Models	12
Roll-In & Roll-Thru Installation	13
New Hinge Cartridge Installation	14
Accessory Interior Drawer Installation	14
T-1 Tray Slide Installation	15
T-2 Tray Slide Installation	16
T-3 Tray Slide Installation	17
T-4 Rack Slide Installation	18
Optional Foot Pedal Installation Instructions	19

Section 3

Operation

Refrigerator & Freezer Operation	21
Refrigerator & Freezer Start Up	21
Evaporator Fan Operation	22
Heated Cabinet Operation	22
Heated Cabinet Start Up	22
Fan Operation	22
High Temperature Safety Device	23
Power Down	23
Home Screen	23
TouchScreen Password	24
Configuration Screen	25
Settings Screen	25
Units	26
Defrost Type (Refrigerator & Freezer)	26
Set Box Temperature	27
Alarm Management	28
Network Connection	28
Interior Light	29
Time / Date	30
Language	30
LCD Brightness	31
Manual Defrost	31
Web Application	31
KitchenConnect	31
Mobile Application	31
Specification Line Connect	31
Application Operation	32
Equipment Management	32

Section 4

Maintenance

Responsibility	33
Interior Cleaning	34
Gaskets	34
Preventing Blower Coil Corrosion	34
Exterior Cleaning	34
Drain	34
Doors/Hinges	34
Cleaning the Condenser Coil	34

Section 5

Troubleshooting

Problem -> Cause -> Correction Chart	35
--	----

**Section 6
Control**

Service Screens 37
 Frame Heater (Freezer Only) 37
 Rapid Pull Down (Refrigerator Only)..... 37
 Diagnostics..... 38
 Relay Status..... 38
 Data History 39
 Energy Chart 39
 Temperature Chart 39
 Temperature Probes..... 40
 Relay Outputs..... 40
 Network Connection 41
 Set Up Connection 41
 Complete Network Setup 42
 Add A Network Screen..... 42
 IP Address Setup Screen..... 43
 Password..... 43
 Firmware Update 44
 Reset Factory Settings..... 45
 Alarm History Screen..... 45
 Alarm Screens..... 46
 Refrigerator & Freezer Alarms..... 47

**Section 7
Component Check Procedures**

Evaporator Fan Access..... 49
Condenser Fan Access 50
Unit Air Flow Design 50
Frame Heater Routing 51
Door Hinges 52
Temperature Probe Resistance..... 53
LED Light Replacement 54
Door Gasket 55

**Section 8
Refrigeration**

R290

Charging Procedures..... 57
System Contamination Clean-up..... 58
Mild System Contamination Clean-Up Procedure . 59
Severe Contamination Clean-Up Procedure..... 59
Filter Driers..... 60
Refrigerant Re-Use Policy 60
Properties of R-290 (Propane) 61
Service Procedures 62
Review 63
Normal Operating Temperatures 64
 1 Section Reach-In Refrigerator 64
 2 Section Reach-In Refrigerator 67
 3 Section Reach-In Refrigerator 70
 1 Section Reach-In Freezer 73
 2 Section Reach-In Freezer 76
 3 Section Reach-In Freezer 79
 1 Section Pass-Thru Refrigerator 82
 2 Section Pass-Thru Refrigerator 85
 1 Section Pass-Thru Freezer..... 88
 2 Section Pass-Thru Freezer..... 91

**Section 9
Diagrams**

Refrigerator Wiring Diagram 95
Freezers With One Compressor Wiring Diagram 96
Freezers With Two Compressors Wiring Diagram .. 97
One Section Dual Temperature Wiring Diagram 98
Two Section Dual Temperature Wiring Diagram 99
One Section Heated Cabinet Wiring Diagram 100
Two Section Heated Cabinet Wiring Diagram 101

Section 1

General Information

Model Numbers

This manual covers the following models:

One Door Section	Two Door Section	Three Door Section
Reach-In Dual Temperature		
GADBR1P-SH GADTR1P-SH	GADFL2P-S GADRL2P-S	-
Reach-In Freezer		
GAF1P-S(H)	GAF2P-S(H)	GAF3P-S(H)
Pass-Thru Freezer		
GAFPT1P-S(H)	GAFPT2P-S(H)	-
Roll-In Freezer		
GAFRI1P-S	GAFRI2P-S	-
Reach-In Heated		
GAH1-G(H)	GAH2-G(H)	-
GAH1-S(H)	GAH2-S(H)	-
Pass-Thru Heated		
GAHPT1-G(H)	GAHPT2-G(H)	-
GAHPT1-S(H)	GAHPT2-S(H)	-
Roll-In Heated		
GAHRI1-G	GAHRI2-G	-
GAHRI1-S	GAHRI2-S	-
Roll-Thru Heated		
GAHRT1-S	GAHRT2-S	-
Narrow Reach-In Refrigerator		
GAR1NP-G(H)	GAR2NP-G(H)	-
GAR1NP-S(H)	GAR2NP-S(H)	-
Reach-In Refrigerator		
GAR1P-G(H)	GAR2P-G(H)	GAR3P-G(H)
-	GAR2P-GL	-
GAR1P-S(H)	GAR2P-S(H)	GAR3P-S(H)
Reach-In Fishfile		
GARFF1P-D	-	-
Pass-Thru Refrigerator		
GARPT1P-G(H)	GARPT2P-G(H)	-
GARPT1P-S(H)	GARPT2P-S(H)	-
Roll-In Refrigerator		
GARRI1P-G	GARRI2P-G	-
GARRI1P-S	GARRI2P-S	-
Roll-Thru Refrigerator		
GARRT1P-S	GARRT2P-S	-

Serial Number Information

The model number and serial number are on the identification plate. The identification plate is located near the top front corner of the left interior wall.

Always have the serial number of your unit available when calling for parts or service.

Warranty Information



Visit

<http://www.delfield.com/warranty> to:

- Register your product for warranty.
- Verify warranty information.
- View and download a copy of your warranty.

Regulatory Certifications

Models are certified by:

-  National Sanitation Foundation (NSF)
-  Underwriters Laboratories (UL)
-  Underwriters Laboratories of Canada (cUL)

THIS PAGE INTENTIONALLY LEFT BLANK

Section 2 Installation

⚠ DANGER

Installation must comply with all applicable fire and health codes in your jurisdiction.

⚠ DANGER

Use appropriate safety equipment during installation and servicing.

Location

⚠ Warning

This equipment must be positioned so that the plug is accessible unless other means for disconnection from the power supply (e.g., circuit breaker or disconnect switch) is provided.

⚠ Warning

Adequate means must be provided to limit the movement of this appliance without depending on or transmitting stress to the electrical cord.

⚠ Warning

To avoid instability the installation area must be capable of supporting the combined weight of the equipment and product. Additionally the equipment must be level side to side and front to back.

⚠ Warning

This equipment is intended for indoor use only. Do not install or operate this equipment in outdoor areas.

The location selected for the equipment must meet the following criteria. If any of these criteria are not met, select another location.

- Units are intended for indoor use only.
- The location **MUST** be level, stable and capable of supporting the weight of the equipment.
- The location **MUST** be free from and clear of combustible materials.
- Equipment **MUST** be level both front to back and side to side.
- Position the equipment so it will not tip or slide.
- Front casters **MUST** be locked once positioned.

- Recommended air temperature is 60° - 100°F (16° - 38°C).
- Proper air supply for ventilation is **REQUIRED AND CRITICAL** for safe and efficient operation. Refer to Clearance Requirements chart on page 9.
- Do not obstruct the flow of ventilation air. Make sure the air vents of the equipment are not blocked.
- Do not install the equipment where air vents are blowing directly at it.
- Do not install the equipment directly over a drain. Steam rising up out of the drain will adversely affect operation, air circulation, and damage electrical / electronic components.

Clearance Requirements

⚠ DANGER

Minimum clearance requirements are the same for noncombustible locations as for combustible locations. The flooring under the appliance must be made of a noncombustible material.

⚠ DANGER

Risk of fire/shock. All minimum clearances must be maintained. Do not obstruct vents or openings.

Top

12.00" (305mm)

- Keep the vents clean and free of obstruction.
- Casters or optional legs must be used and not removed.

Drain Connections

⚠ Warning

Moisture collecting from improper drainage can create a slippery surface on the floor and a hazard to employees. It is the owner's responsibility to provide a container or outlet for drainage.

FLOOR DRAIN REQUIRED

Dual Temperature Reach-In Models GADBR1P-SH & GADTR1P-SH

Single section dual temperature reach-ins require plumbing to a floor drain as they do not have hot gas condensate removal.

Weight, Capacity & Dimensions of Equipment

Model	Weight	Shelf Qty	Shelf Area	Volume	Length	Depth	Height
Reach-In Dual Temperature							
GADBR1P-SH GADTR1P-SH	398lbs (181kg)	(2X)2	(2X)8ft ² (7432cm ²)	(2X)8.6ft ³ (244L)	27.40" (70cm)	32.44" (82cm)	79.50" (202cm)
GADFL2P-S GADRL2P-S	575lbs (261kg)	6	25.25ft ² (23458cm ²)	42ft ³ (1189L)	55.22" (140cm)	32.44" (82cm)	79.50" (202cm)
Reach-In Freezer							
GAF1P-S(H)	354lbs (161kg)	3	11.5ft ² (10684cm ²)	21ft ³ (595L)	27.40" (70cm)	32.44" (82cm)	79.50" (202cm)
GAF2P-S(H)	495lbs (225kg)	6	25.25ft ² (23458cm ²)	46ft ³ (1303L)	55.22" (140cm)		
GAF3P-S(H)	772lbs (350kg)	9	39ft ² (36232cm ²)	71ft ³ (2011L)	83.00" (211cm)		
Pass-Thru Freezer							
GAFPT1P-S(H)	452lbs (205kg)	3	12.12ft ² (11260cm ²)	23ft ³ (651L)	27.40" (70cm)	34.75" (88cm)	79.50" (202cm)
GAFPT2P-S(H)	682lbs (309kg)	6	26.5ft ² (24619cm ²)	50ft ³ (1416L)	55.22" (140cm)		
Roll-In Freezer							
GAFRI1P-S	466lbs (211kg)	NA	NA	37ft ³ (1048L)	34.00" (86cm)	34.00" (86cm)	89.00" (226cm)
GAFRI2P-S	690lbs (313kg)	NA	NA	76.5ft ³ (2166L)	66.00" (168cm)		
Reach-In Heated							
GAH1-G(H)	361lbs (164kg)	3	11.5ft ² (10684cm ²)	21ft ³ (595L)	27.40" (70cm)	32.44" (82cm)	79.50" (202cm)
GAH1-S(H)	333lbs (151kg)						
GAH2-G(H)	640lbs (290kg)	6	25.5ft ² (23690cm ²)	46ft ³ (1303L)	55.22" (140cm)		
GAH2-S(H)	630lbs (286kg)						
Pass-Thru Heated							
GAHPT1-G(H)	361lbs (164kg)	3	11.5ft ² (10684cm ²)	23ft ³ (651L)	27.40" (70cm)	34.75" (88cm)	79.50" (202cm)
GAHPT1-S(H)	333lbs (151kg)						
GAHPT2-G(H)	640lbs (290kg)	6	25.5ft ² (23690cm ²)	50ft ³ (1416L)	55.22" (140cm)		
GAHPT2-S(H)	630lbs (286kg)						
Roll-In Heated							
GAHRI1-G	486lbs (220kg)	NA	NA	37ft ³ (1048L)	34.00" (86cm)	34.00" (86cm)	89.00" (226cm)
GAHRI1-S	446lbs (202kg)						
GAHRI2-G	745lbs (338kg)	NA	NA	76.5ft ³ (2166L)	66.00" (168cm)		
GAHRI2-S	715lbs (324kg)						
Roll-Thru Heated							
GAHRT1-S	465lbs (211kg)	NA	NA	39ft ³ (1104L)	34.00" (86cm)	36.12" (92cm)	89.00" (226cm)
GAHRT2-S	683lbs (310kg)	NA	NA	80.5ft ³ (2280L)	66.00" (168cm)		
Narrow Reach-In Refrigerator							
GAR1NP-G(H)	391lbs (177kg)	3	9.75ft ² (9058cm ²)	18ft ³ (510L)	24.00" (61cm)	32.44" (82cm)	79.50" (202cm)
GAR1NP-S(H)	361lbs (164kg)						
GAR2NP-G(H)	652lbs (296kg)	6	21.75ft ² (20206cm ²)	40ft ³ (1133L)	48.42" (123cm)		
GAR2NP-S(H)	632lbs (287kg)						
Reach-In Refrigerator							
GAR1P-G(H)	351lbs (159kg)	3	11.5ft ² (10684cm ²)	21ft ³ (595L)	27.40" (70cm)	32.44" (82cm)	79.50" (202cm)
GAR1P-S(H)	236lbs (107kg)						
GAR2P-G(H)	495lbs (225kg)	6	25.25ft ² (23458cm ²)	46ft ³ (1303L)	55.22" (140cm)		
GAR2P-GL	490lbs (222kg)						
GAR2P-S(H)	322lbs (146kg)	9	39ft ² (36232cm ²)	71ft ³ (2011L)	83.00" (211cm)		
GAR3P-G(H)	767lbs (348kg)						
GAR3P-S(H)	485lbs (220kg)						
Reach-In Fishfile							
GARFF1P-D	675lbs (306kg)	NA	NA	21ft ³ (595L)	27.40" (70cm)	32.44" (82cm)	79.50" (202cm)
Pass-Thru Refrigerator							
GARPT1P-G(H)	472lbs (214kg)	3	12.12ft ² (11260cm ²)	23ft ³ (651L)	27.40" (70cm)	34.75" (88cm)	79.50" (202cm)
GARPT1P-S(H)	448lbs (203kg)						
GARPT2P-G(H)	680lbs (308kg)	6	26.5ft ² (24619cm ²)	50ft ³ (1416L)	55.22" (140cm)		
GARPT2P-S(H)	652lbs (296kg)						
Roll-In Refrigerator							
GARRI1P-G	486lbs (220kg)	NA	NA	37ft ³ (1048L)	34.00" (86cm)	34.00" (86cm)	89.00" (226cm)
GARRI1P-S	446lbs (202kg)						
GARRI2P-G	745lbs (338kg)	NA	NA	76.5ft ³ (2166L)	66.00" (168cm)		
GARRI2P-S	715lbs (324kg)						
Roll-Thru Refrigerator							
GARRT1P-S	486lbs (220kg)	NA	NA	39ft ³ (1104L)	34.00" (86cm)	36.12" (92cm)	89.00" (226cm)
GARRT2P-S	683lbs (310kg)	NA	NA	80.5ft ³ (2280L)	66.00" (168cm)		

Electrical Service

⚠ DANGER

Check all wiring connections, including factory terminals, before operation. Connections can become loose during shipment and installation.

⚠ Warning

This appliance must be grounded and all field wiring must conform to all applicable local and national codes. Refer to rating plate for proper voltage. It is the responsibility of the end user to provide the disconnect means to satisfy the authority having jurisdiction.

- Plug units with R290 refrigerant into a receptacle that is a minimum of 14" (36cm) above the floor.
- All electrical work, including wire routing and grounding, must conform to local, state and national electrical codes.
- The equipment must be grounded.
- A separate fuse/circuit breaker must be provided for each unit.
- The maximum allowable voltage variation is ±10% of the rated voltage at equipment start-up (when the electrical load is highest).
- Check all green ground screws, cables and wire connections to verify they are tight before start-up.

GROUND FAULT CIRCUIT INTERRUPTER

Ground Fault Circuit Interrupter (GFCI/GFI) protection is a system that shuts down the electric circuit (opens it) when it senses an unexpected loss of power, presumably to ground. Welbilt does not recommend the use of GFCI/GFI circuit protection to energize our equipment. If code requires the use of a GFCI/GFI then you must follow the local code. The circuit must be dedicated, sized properly and there must be a panel GFCI/GFI breaker. We do not recommend the use of GFCI/GFI outlets to energize our equipment as they are known for more intermittent nuisance trips than panel breakers.

ELECTRICAL SPECIFICATION CHART

Maximum 10ft (3m) cord with plug.

Model	Amps	V, Hz, Ph	H.P.	Nema Plug
Reach-In Dual Temperature				
GADBR1P-SH GADTR1P-SH	5.8	115, 60, 1	Ref. 0.20 Frzr. 0.315	5-15P
GADFL2P-S GADRL2P-S	11.4	115, 60, 1	Ref. 0.22 Frzr. 0.55	5-15P
Reach-In Freezer				
GAF1P-S(H)	7.2	115, 60, 1	0.55	5-15P
GAF2P-S(H)	10.0	115, 60, 1	0.68	5-15P
GAF3P-S(H)	14.7	115, 60, 1	(2X)0.55	5-20P
Pass-Thru Freezer				
GAFPT1P-S(H)	10.0	115, 60, 1	0.55	5-15P
GAFPT2P-S(H)	14.6	115, 60, 1	(2X)0.55	5-20P
Roll-In Freezer				
GAFRI1P-S	10.0	115, 60, 1	0.68	5-15P
GAFRI2P-S	14.6	115, 60, 1	(2X)0.55	5-20P
Reach-In Heated				
GAH1-G(H)	6.0	208-240, 60, 1	NA	6-20P
GAH1-S(H)	6.0			
GAH2-G(H)	10.5	208-240, 60, 1	NA	6-20P
GAH2-S(H)	10.5			
Pass-Thru Heated				
GAHPT1-G(H)	6.0	208-240, 60, 1	NA	6-20P
GAHPT1-S(H)	6.0			
GAHPT2-G(H)	10.5	208-240, 60, 1	NA	6-20P
GAHPT2-S(H)	10.5			
Roll-In Heated				
GAHRI1-G	6.0	208-240, 60, 1	NA	6-20P
GAHRI1-S	6.0			
GAHRI2-G	10.5	208-240, 60, 1	NA	6-20P
GAHRI2-S	10.5			
Roll-Thru Heated				
GAHRT1-S	6.0	208-240, 60, 1	NA	6-20P
GAHRT2-S	10.5	208-240, 60, 1	NA	6-20P
Narrow Reach-In Refrigerator				
GAR1NP-G(H)	4.2	115, 60, 1	0.22	5-15P
GAR1NP-S(H)	4.2			
GAR2NP-G(H)	6.0	115, 60, 1	0.33	5-15P
GAR2NP-S(H)	6.0			
Reach-In Refrigerator				
GAR1P-G(H)	4.2	115, 60, 1	0.22	5-15P
GAR1P-S(H)	4.2			
GAR2P-G(H)	6.0	115, 60, 1	0.33	5-15P
GAR2P-GL	6.0			
GAR2P-S(H)	6.0			
GAR3P-G(H)	6.5	115, 60, 1	0.355	5-15P
GAR3P-S(H)	6.5			
Reach-In Fishfile				
GARFF1P-D	4.2	115, 60, 1	0.22	5-15P
Pass-Thru Refrigerator				
GARPT1P-G(H)	4.5	115, 60, 1	0.22	5-15P
GARPT1P-S(H)	4.5			
GARPT2P-G(H)	6.2	115, 60, 1	0.33	5-15P
GARPT2P-S(H)	6.2			

Model	Amps	V, Hz, Ph	H.P.	Nema Plug
Roll-In Refrigerator				
GARRI1P-G	4.5	115, 60, 1	0.33	5-15P
GARRI1P-S	4.5			
GARRI2P-G	6.2	115, 60, 1	0.355	5-15P
GARRI2P-S	6.2			
Roll-Thru Refrigerator				
GARRT1P-S	4.5	115, 60, 1	0.33	5-15P
GARRT2P-S	6.2	115, 60, 1	0.355	5-15P

ENERGY USE

Model	Energy Use in kWh	Energy Star® Certified
Reach-In Dual Temperature		
GADBR1P-SH	4.2576	
GADTR1P-SH		
GADFL2P-S	4.87025	
GADRL2P-S		
Reach-In Freezer		
GAF1P-S	5.863	
GAF1P-SH	5.59	✓
GAF2P-S	10.65	
GAF2P-SH	9.69	✓
GAF3P-S	10.50	✓
GAF3P-SH	12.20	✓
Pass-Thru Freezer		
GAFPT1P-S	5.1112	
GAFPT1P-SH	5.2623	
GAFPT2P-S	9.337	✓
GAFPT2P-SH	11.3327	✓
Roll-In Freezer		
GAFRI1P-S	7.6144	✓
GAFRI2P-S	14.3393	✓
Reach-In Heated		
GAH1-G	159.3144	✓
GAH1-GH	183.6433	✓
GAH1-S	141.1322	✓
GAH1-SH	145.0789	✓
GAH2-G	302.5585	✓
GAH2-GH	299.055	✓
GAH2-S	245.5875	✓
GAH2-SH	233.8808	✓
Pass-Thru Heated		
GAHPT1-G	228.636	✓
GAHPT1-GH	234.906	✓
GAHPT1-S	171.9222	✓
GAHPT1-SH	192.0701	✓
GAHPT2-G	421.2567	
GAHPT2-GH	408.354	
GAHPT2-S	290.2969	✓
GAHPT2-SH	300.2424	✓
Roll-In Heated		
GAHRI1-G	308.6124	✓
GAHRI1-S	241.5638	✓
GAHRI2-G	560.6883	
GAHRI2-S	427.798	✓

Model	Energy Use in kWh	Energy Star® Certified
Roll-Thru Heated		
GAHRT1-S	295.3889	✓
GAHRT2-S	504.6286	✓
Narrow Reach-In Refrigerator		
GAR1NP-G	1.9248	✓
GAR1NP-GH	1.9848	✓
GAR1NP-S	1.8296	
GAR1NP-SH	1.7665	
GAR2NP-G	2.5934	✓
GAR2NP-GH	2.3738	✓
GAR2NP-S	2.1157	✓
GAR2NP-SH	2.0552	✓
Reach-In Refrigerator		
GAR1P-G	2.08	✓
GAR1P-GH	1.66	✓
GAR1P-S	1.85	✓
GAR1P-SH	1.70	✓
GAR2P-G	3.18	✓
GAR2P-GH	2.91	✓
GAR2P-GL	3.18	
GAR2P-S	2.71	✓
GAR2P-SH	2.49	✓
GAR3P-G	4.92	✓
GAR3P-GH	4.55	✓
GAR3P-S	3.59	✓
GAR3P-SH	3.54	✓
Reach-In Fishfile		
GARFF1P-D		
Pass-Thru Refrigerator		
GARPT1P-G	2.4461	
GARPT1P-GH	2.4620	
GARPT1P-S	1.7873	✓
GARPT1P-SH	1.9876	
GARPT2P-G	3.6743	✓
GARPT2P-GH	3.5395	✓
GARPT2P-S	2.3019	✓
GARPT2P-SH	2.4898	✓
Roll-In Refrigerator		
GARRI1P-G	2.7366	✓
GARRI1P-S	2.2998	✓
GARRI2P-G	5.1789	✓
GARRI2P-S	5.1258	
Roll-Thru Refrigerator		
GARRT1P-S	2.4859	✓
GARRT2P-S	4.6395	

Refrigeration

Model	Heat of Rejection (BTU)	BTU/Hour Capacity	R290 Charge
Reach-In Dual Temperature			
GADBR1P-SH	Ref. 232	Ref. 1431	Ref. 78g
GADTR1P-SH	Frzr. 401	Frzr. 1094	Frzr. 62g
GADFL2P-S	Ref. 420	Ref. 1920	Ref. 113g
GADRL2P-S	Frzr. 790	Frzr. 2035	Frzr. 93g
Reach-In Freezer			
GAF1P-S(H)	790	2035	93g
GAF2P-S(H)	1380	2485	109g
GAF3P-S(H)	1800	4070	(2X)110g
Pass-Thru Freezer			
GAFT1P-S(H)	930	2035	93g
GAFT2P-S(H)	1630	4070	(2X)110g
Roll-In Freezer			
GAFRI1P-S	1401	2261	109g
GAFRI2P-S	2458	4523	(2X)110g
Narrow Reach-In Refrigerator			
GAR1NP-G(H)	540	1860	113g
GAR1NP-S(H)	390	1860	113g
GAR2NP-G(H)	890	2470	113g
GAR2NP-S(H)	590	2470	113g
Reach-In Refrigerator			
GAR1P-G(H)	570	1920	113g
GAR1P-S(H)	420	1920	113g
GAR2P-G(H)	930	2540	113g
GAR2P-GL	1606	3370	113g
GAR2P-S(H)	620	2540	113g
GAR3P-G(H)	1400	3865	118g
GAR3P-S(H)	940	3865	118g
Reach-In Fishfile			
GARFF1P-D	570	1920	113g
Pass-Thru Refrigerator			
GARPT1P-G(H)	690	1860	113g
GARPT1P-S(H)	460	1860	113g
GARPT2P-G(H)	1260	3760	113g
GARPT2P-S(H)	800	3760	113g
Roll-In Refrigerator			
GARRI1P-G	800	2470	113g
GARRI1P-S	680	2470	113g
GARRI2P-G	1460	3760	118g
GARRI2P-S	1230	3760	118g
Roll-Thru Refrigerator			
GARRT1P-S	830	2470	113g
GARRT2P-S	1530	3760	118g

Leg & Caster Installation

Warning

The unit must be installed in a stable condition with the front wheels locked. Locking the front casters after installation is the owner’s and operator’s responsibility.

Warning

Use a jack to lift the refrigeration unit off the ground just far enough to remove the leg/caster. Place blocking underneath the unit. Do not work underneath a raised unit without proper blocking. Do not lift the unit more than necessary to remove the leg/caster. Lifting the unit too far can make the unit unstable.

Caution

All single-section units require that the swivel casters be mounted on the front and rigid casters be mounted on the rear.

To install the legs or casters:

1. Remove unit from skid.

NOTE: The bolts used to hold the unit to the skid should be re-used as the fourth hex head bolt for each caster or leg plate installation. The bolt should not measure over 2” (5cm) in length.
2. Raise unit to access leg/caster mounting holes on bottom of unit.
3. Attach the legs or casters to bottom of cabinet using hex head bolts.

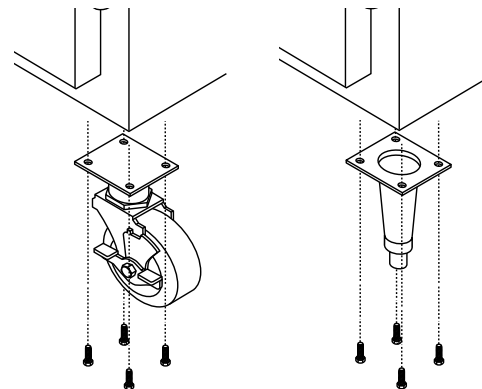

Level & Stable

After the cabinet has been placed in the desired location, cabinets must be leveled. Level units from front to back and from side to side. Leveling will insure proper door operation and removal of condensate.

- It is very important that all legs are properly adjusted to keep the cabinet level, evenly distribute the weight and to make sure the unit will not rock, lean or be unstable.
- Cabinets with casters must have the caster brake set so the cabinet cannot move. Shim casters if necessary to level unit.
- Roll-In and roll-thru units must also be level. Shim the bottom of the unit if necessary. See Roll-In & Roll-Thru Installation on page 13.
- Adjust doors and hinges until doors close properly.

Shelf Installation

1. Insert the clips into the pilaster holes at the desired shelf heights.

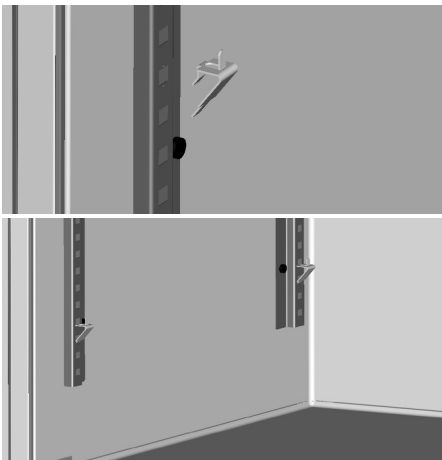

2. Set the shelves on the clips.

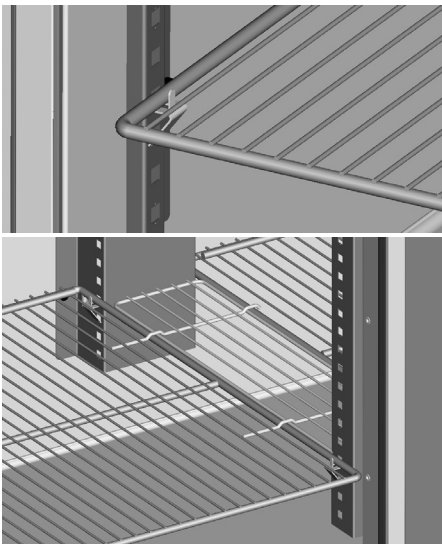

Reversible Door Instructions

APPLICABLE TO FULL DOOR MODELS

1. Open the door.
2. Remove two bolts securing the hinge bracket above the door.

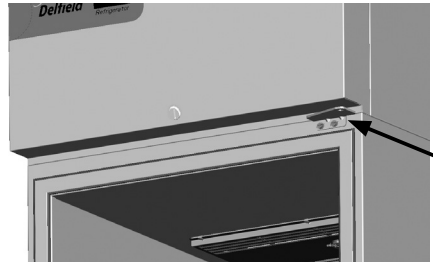

3. Lift the door up and out.
4. Save the hinge bracket.
5. Remove three bolts securing the hinge bracket to the bottom of the unit.

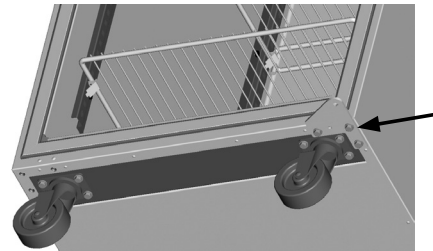

6. Flip it over and install it on the opposite side.

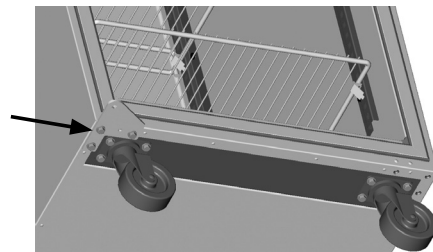

7. Rotate the door 180°.
8. Move the white nylon washer from the top hinge pin to the bottom hinge pin.
9. Insert the bottom hinge pin into the hinge bracket.

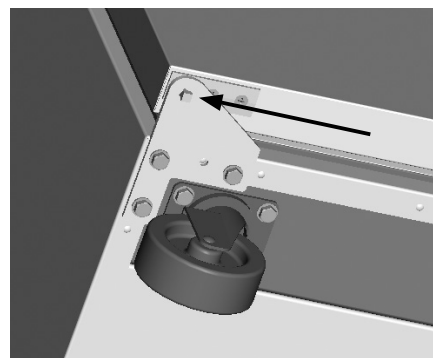

10. Locate the provided alternate top hinge bracket.
11. Place the hinge bracket over the top hinge pin.
12. Open the door.
13. Using the original screws install the hinge bracket on the new side in the vacant lock holes.

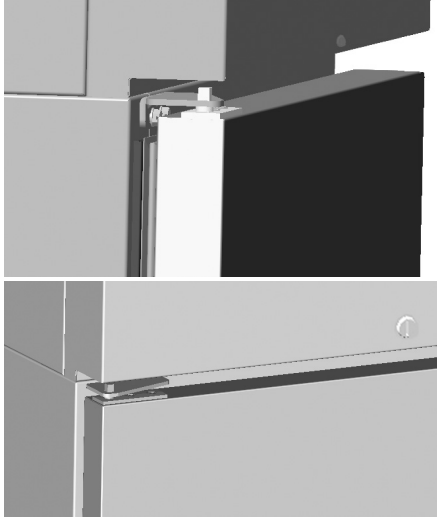

14. Check for proper closure and gasket seal.
15. Adjust hinges as needed.

Roll-In & Roll-Thru Installation

NOTE: Local area codes may dictate other installation requirements not mentioned.

1. Verify unit is level with 4' Level. Shim as needed. Depending on the height of the shims, stainless trim may be needed to fill in a large gap between the unit and the floor.
2. Remove door sweep before making door adjustments.
3. Adjust doors hinges so door closes by itself.
 - A properly adjusted door will close and seal when the door is held open 3" or less with no assistance.
4. Reinstall door sweep. It may need to be reinstalled in new holes so that it does not interfere with the door closing.
 - If it is too tight to ramp it will hold door open.
 - Make sure sweep is just touching ramp when closed.

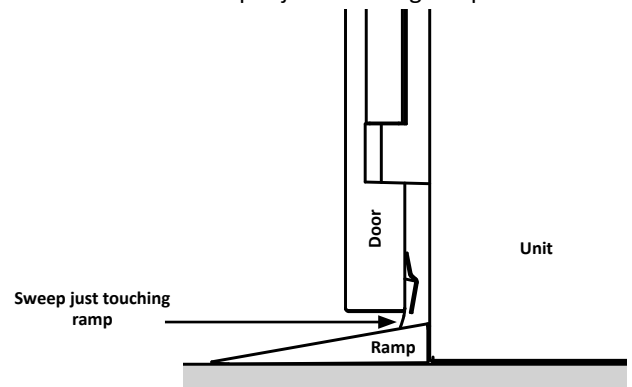

5. Verify once again that the door will close and seal when held open 3" or less.
6. If this is a multi-section unit make sure door stays shut or closes by itself when other doors are shut.
7. Using silicone, seal the ramp to the floor; seal the unit to the floor and walls. The silicone will make sure that no water can get under the unit or ramps. If shims and stainless trim are added they also need to be sealed to the unit and the floor.

New Hinge Cartridge Installation

- Full doors have a cartridge hinge on both the bottom and top of the door.
 - Half doors only have one cartridge hinge, the bottom hinge of the bottom half door and the top hinge of the top half door.
1. Install the new cartridge into the door as received. The new cartridge will be in the CLOSED position.

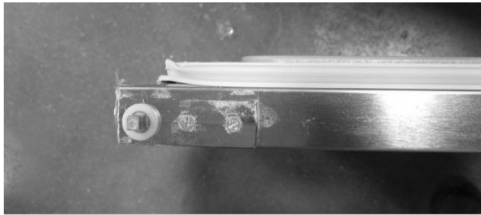

2. As you unload the hinge tension be careful to hold on tight because you should feel the strong spring tension as you rotate the hinge. Place the hinge bracket on the square hinge pin and rotate it ½ turn to the outside of the door.



3. After the hinge has been rotated, it will now be in the OPEN position and NOT under spring tension.

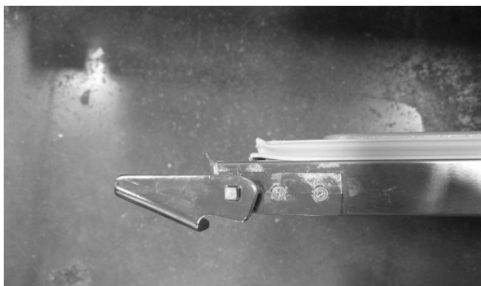

4. Mount the door back onto the cabinet with the door OPEN. The door should now close properly.
5. Begin closing the door, the door should finish closing on it's own. If the door stays open remove the door and hinge bracket.
6. Using the hinge bracket rotate the square peg on the cartridge until you feel tension and resistance if you move the hinge in either direction. The hinge is now in the CLOSED position. Repeat instructions starting with step 2.

Accessory Interior Drawer Installation

1. Accessory drawer installation requires two tracks and a drawer.

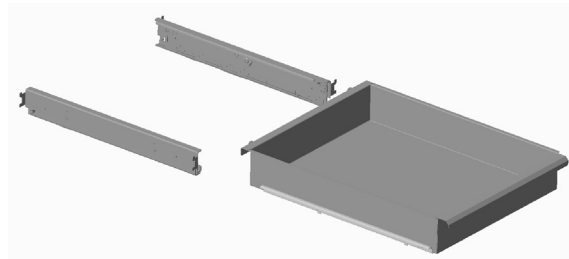

2. Hang the drawer tracks on the pilaster strips across from each other. Verify the tracks are lined up evenly.

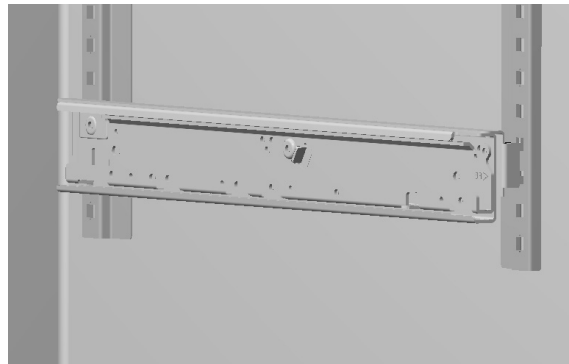

3. Slide the drawer box into the tracks slowly. When the drawer box is half way in it will hit a STOP. Lift the front of the drawer up slightly to continue.



T-1 Tray Slide Installation

Edge Support for 18" x 26" pans

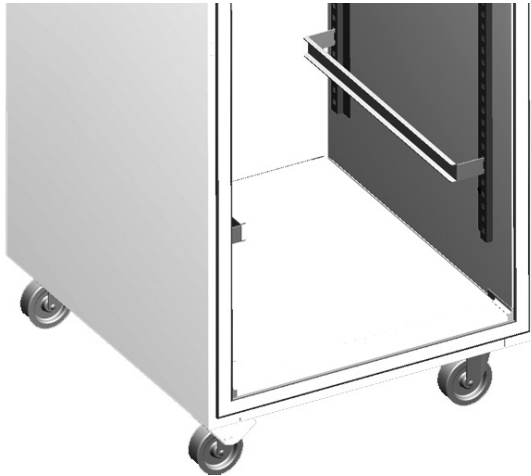

Installed T-1 Tray Slide for 18"x 26" Pans

System Name	T-1
Slide Style	Tray
Support Style	Edge
Compatible with 12" x 20" Pans	No
Compatible with 18" x 26" Pans	Yes

- The T-1 tray slide system is designed to support 18" x 26" pans by the edge of the pan.
- The slides are shaped as a C channel.
- Each set of tray slides is mounted at the same height across a door section.
- For each pan, one set of two (2) tray slides is used. The exception is 1.5" spacing.
- For 1.5" spacing, the tray slides are mounted every 3" and the top and bottom of each tray slide is used to hold a pan.

Centerline Spacing					
1.5"	2.0"	3.0"	4.0"	5.0"	6.0"
Maximum Tray Slides for a Full Section					
15	23	15	12	9	8
Maximum Tray Slides for a Half Section (Top or Bottom)					
7	10	7	5	4	4

T-1 Installation Instructions

1. For each pan, mount a pair of tray slides; one on each side of the door section at the same height. Mount the tray slides onto the pilasters by sliding the tray slide tabs down into the cutouts. Make sure that all tabs are engaged securely to each pilaster.

NOTE: A dead-blow hammer is recommended to seat the tab into the cutouts.

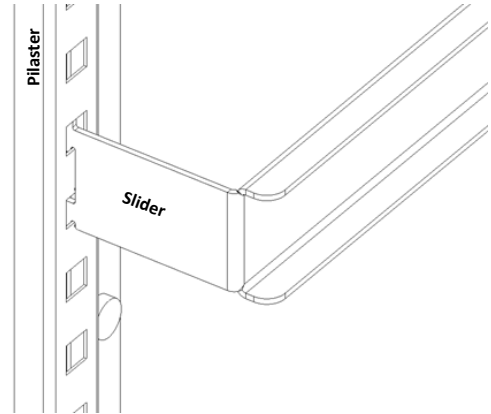

2. Verify that all tray slides are lined up evenly.

NOTE: An easy check to verify correct installation is to slide an 18" x 26" pan onto each slide. If the pan is held securely, and is level inside the door section, the installation has been successful.

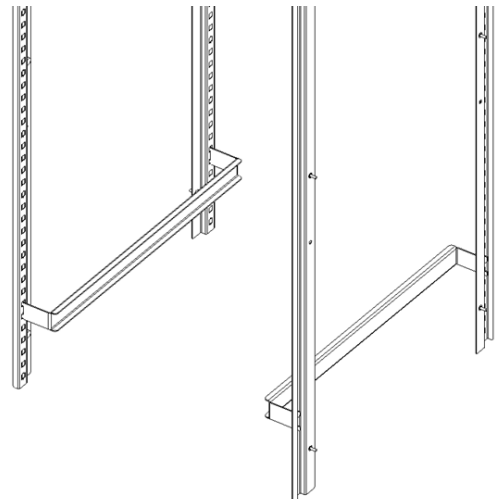

T-2 Tray Slide Installation

Universal Bottom Support for 12" x 20" and 18" x 26" pans



Installed T-2 tray slide with both size pans

System Name	T-2
Slide Style	Tray
Support Style	Bottom
Compatible with 12" x 20" Pans	Yes
Compatible with 18" x 26" Pans	Yes

- The T-2 (Universal) tray slide system is designed to support both 12" x 20" and 18" x 26" pans by the bottom.
- The tray slide is an L shaped piece of formed stainless steel.
- Each set of tray slides is mounted at the same height across a door section.
- For each pan, one set of two (2) tray slides is used.

Centerline Spacing				
2.0"	3.0"	4.0"	5.0"	6.0"
Maximum Tray Slides for a Full Section				
23	15	12	9	8
Maximum Tray Slides for a Half Section (Top or Bottom)				
10	7	5	4	4

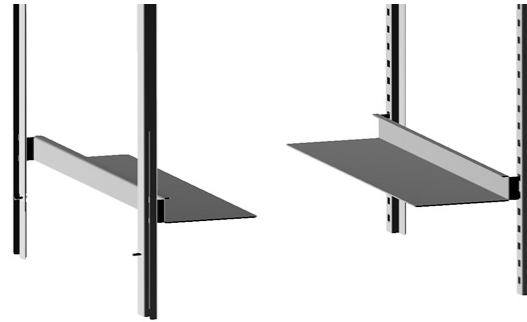

T-2 Tray Slide System

T-2 Installation Instructions

1. For each pan, two (2) tray slides will be used. Each tray slide must have another tray slide at the same height, on the opposite side of the door section. Mount the tray slides onto the pilasters by sliding the tabs down into the pilaster cutouts. Make sure that all tabs are engaged securely to each pilaster.

NOTE: A dead-blow hammer is recommended to seat the tab into the cutouts.

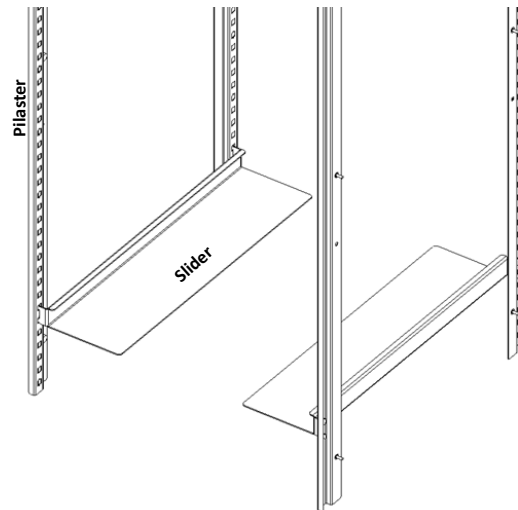

2. Verify that all tray slides are lined up evenly.

NOTE: An easy check to verify correct installation is to slide a pan onto each slide. If the pan is held securely, and is level inside the door section, the installation has been successful.

T-3 Tray Slide Installation

Edge Support for 12" x 20" pans

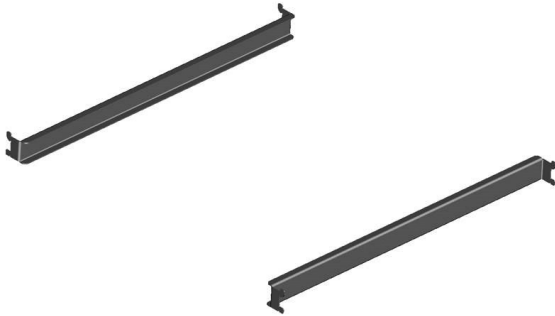

T-3 Tray Slide for 12"x 20" pans

System Name	T-3
Slide Style	Tray
Support Style	Edge
Compatible with 12" x 20" Pans	Yes
Compatible with 18" x 26" Pans	No

- The T-3 tray slide system is designed to support 12" x 20" pans by the edge of the pan.
- The slides are shaped as a C channel.
- Each set of tray slides is mounted at the same height across a door section.
- For each pan, one set of two (2) tray slides is used.

Centerline Spacing			
3.0"	4.0"	5.0"	6.0"
Maximum Tray Slides for a Full Section			
17	12	9	7
Maximum Tray Slides for a Half Section (Top)			
6	5	4	3
Maximum Tray Slides for a Half Section (Bottom)			
8	6	5	4

T-3 Installation Instructions

1. For each pan, two (2) tray slides will be used. Each tray slide must have another tray slide at the same height, on the opposite side of the door section. Mount the tray slides onto the pilasters by sliding the tabs down into the pilaster cutouts. Make sure that all tabs are engaged securely to each pilaster.

NOTE: A dead-blow hammer is recommended to seat the tab into the cutouts.

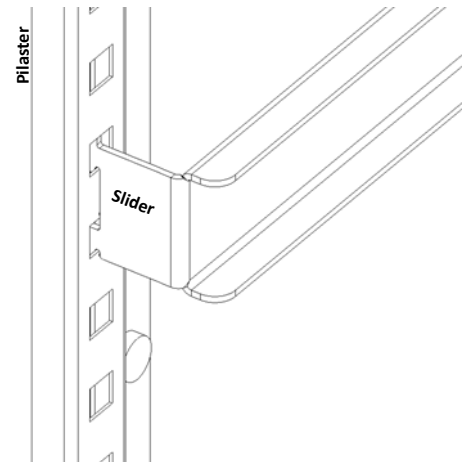

2. Verify that all tray slides are lined up evenly.

NOTE: An easy check to verify correct installation is to slide a pan of the appropriate size into each slide. If the pan is held securely, and is level inside the door section, the installation has been successful.

T-4 Rack Slide Installation

Edge Support for 18" x 26" pans

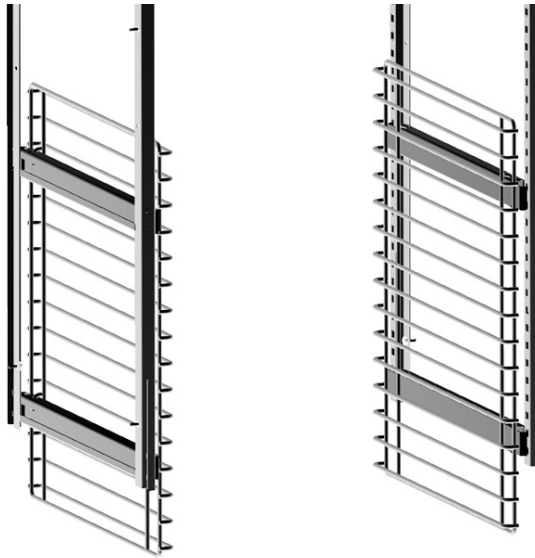

Installed T-4 Tray Slide for 18"x 26" pan

System Name	T-4
Slide Style	Rack
Support Style	Edge
Compatible with 12" x 20" Pans	No
Compatible with 18" x 26" Pans	Yes

- The T-4 rack slide system is designed to support 18" x 26" pans by the edge of the pan.
- The T-4 rack slide system consists mounting plates for each side, and a set of racks.
- The racks are formed of heavy gauge metal wire.
- Each set of rack slides is mounted at the same height across a door section.
- Each rack uses two (2) mounting plates.

T-4 Installation Instructions

1. Start assembling the mounting plates at the bottom of the door section. Place a bottom mounting plate so that each set of tabs engages a cutout on the pilaster. Push the mounting plate down to secure the plate to the cutouts.

NOTE: A dead-blow hammer is recommended to seat the tab into the cutouts.

2. On the same side place a top mounting plate with the bottom edge 20" (51cm) above the top of the lower mounting plate.

3. Repeat steps 1-2 on the opposite side. Verify that all mounting plates are lined up across the door section.
4. For a full section installation, repeat steps 1-3 for the upper half.
5. Place each rack on two (2) mounting plates.

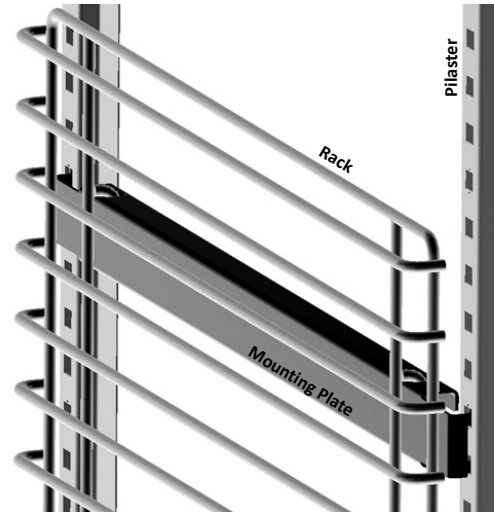

6. Verify that all tray slides are lined up evenly.

NOTE: An easy check to verify correct installation is to slide a pan of the appropriate size into each slide. If the pan is held securely, and is level inside the door section, the installation has been successful.

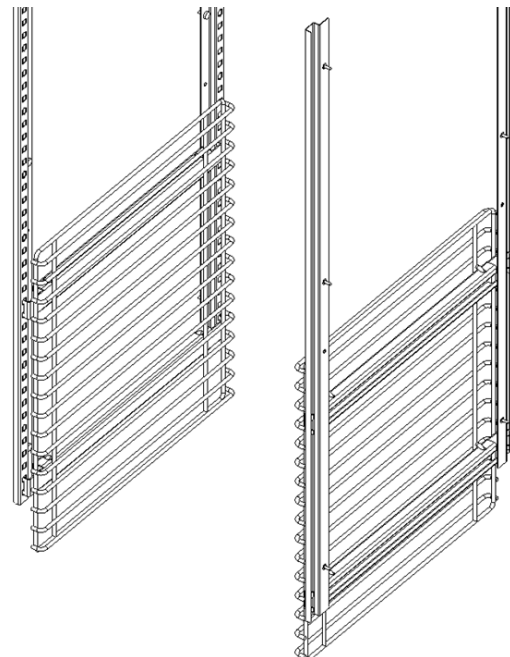

Optional Foot Pedal Installation Instructions

- If the optional foot pedal is ordered for a right hinged door, ensure part # 000-D10-0031 is received.

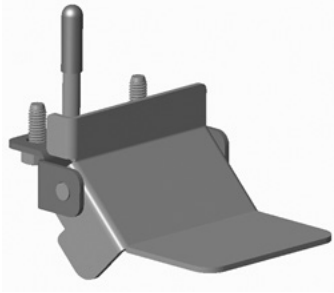

- If the optional foot pedal is ordered for a left hinged door, ensure part # 000-D10-0030 is received.

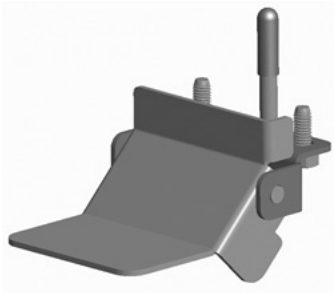

1. Locate foot pedal placement. Placement is on the bottom of the cabinet, opposite of the bottom flat door hinge bracket.

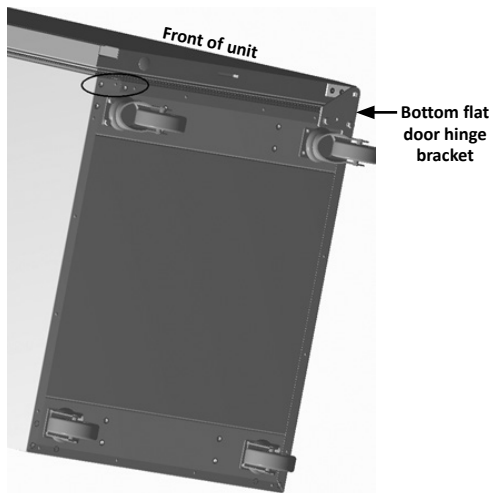

2. Mount foot pedal door assist with (2) 5/16-18 bolts that are provided, use 1/2" socket or wrench. Foot pedal plate should be facing forward and parallel to the floor when door is closed.

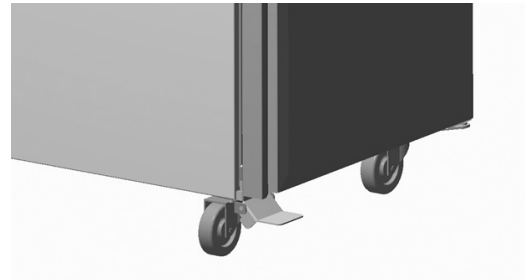

Front View

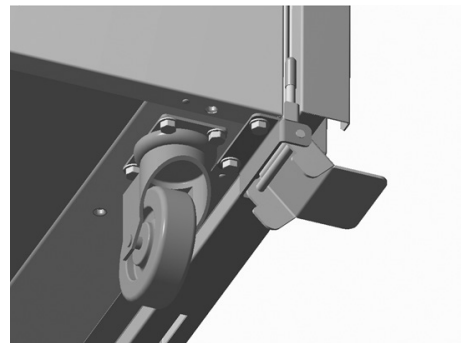

Bottom Side View

3. Step down on top of foot pedal plate and door will swing open.

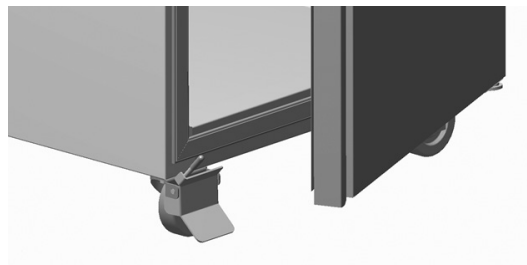

Foot Pedal When Door Is Open

THIS PAGE INTENTIONALLY LEFT BLANK

Section 3 Operation

⚠ DANGER

The on-site supervisor is responsible for ensuring that operators are made aware of the inherent dangers of operating this equipment.

⚠ DANGER

Do not operate any appliance with a damaged cord or plug. All repairs must be performed by a qualified service company.

⚠ DANGER

Keep power cord AWAY from HEATED surfaces. DO NOT immerse power cord in water. DO NOT let power cord hang over edge of table or counter.

⚠ Warning

Do not contact moving parts.

⚠ Warning

All covers and access panels must be in place and properly secured, before operating this equipment.

⚠ Warning

The operator of this equipment is solely responsible for ensuring safe holding temperature levels for all food items. Failure to do so could result in unsafe food products for customers.

⚠ Warning

Overloading shelves can damage equipment or cause bodily injury.

⚠ Warning

Damp or wet hands may stick to cold surfaces.

⚠ Warning

Do not block the supply and return air grills or the air space around the air grills. Keep plastic wrappings, paper, labels, etc. from being airborne and lodging in the grills. Failure to keep the air grills clear will result in unsatisfactory operation of the system.

⚠ Caution

Do not throw items into the storage area. Failure to heed this recommendation could result in damage to the interior of the cabinet or to the blower coil.

Refrigerator & Freezer Operation

- Delfield refrigerators are designed to maintain an operational temperature of 36°F to 40°F (2°C to 4°C).
- Delfield freezers are designed to maintain an operational temperature of 0°F (-18°C).

Refrigerator & Freezer Start Up

Note

Display responds to finger touch only. Do not use utensils or other objects to operate the display. Use of these objects could damage the display.

This also covers anytime power is disconnected then reconnected.

1. Plug the unit in.
2. The screen will appear after a 30 second delay.
3. Select the power icon, located on the right of the screen.



4. The touchscreen will move through the following two screens.





5. The unit will continue through the Defrost mode. The compressor and condenser fan as well as the evaporator fan will remain off until this initial defrost is complete. This initial defrost cycle may take up to 35 minutes to complete.
6. The defrost icon will continue on the display for an additional 30 minutes while the cooling cycle cools the box to the set temperature. Then the box temperature will be displayed.



7. The temperature control will cycle the compressor, evaporator fan motor and condenser fan motor to maintain box temperature at the control setting.

EVAPORATOR FAN OPERATION

During normal operation the evaporator fan may cycle and/or pulse independently of the compressor. Consult Technical Support at 1-844-724-CARE if you are unsure of the proper function.

	Cooling Cycle		Defrost Cycle
	Compressor On	Compressor Off	Compressor Off
Refrigerator	Evap Fan On	Cycles On 2-Min, Off 2-Min	Evap Fan On
Freezer	Evap Fan On	Evap Fan Off	Evap Fan Off

Heated Cabinet Operation

⚠ DANGER

The unit surface is very hot! Avoid direct contact with skin; use appropriate protective apparel, such as gloves.

Delfield heated cabinets are designed to maintain an operational temperature of 165°F (73°C).

Heated Cabinet Start Up

This also covers anytime power is disconnected then reconnected.

1. Plug the unit in.
2. The screen will appear after a 30 second delay.
3. Select the power icon, located on the right of the screen.



4. The home screen will display. Allow unit to warm-up before use. It may take up to two hours to reach the desired temperature.



FAN OPERATION

When heating elements are ON, fan is ON.

When heating elements are OFF, fan cycles OFF for 2 minutes, then ON for 1 minute and repeating this cycle until control turns heating elements back ON.

HIGH TEMPERATURE SAFETY DEVICE

An automatic reset type safety device is mounted above the heater(s) behind the vertical air duct(s). This safety switch will open if the temperature exceeds 220°F (105°C) in the event of a fan failure or air duct obstruction. Whenever the switch opens, power to the heaters is interrupted. Once the safety switch cools sufficiently to automatically reset, operation of the heaters will resume.

Power Down

1. From the settings screen, select Unit Standby.



2. Access to this page requires the manager password.
3. Slide over the System Power button to off.
4. Setting system power to off will shut down the cooling or heating system only. Power will remain to control.



Settings Screen\Unit Standby

5. If the unit is a heated cabinet, allow unit to cool down.
6. Clean equipment as discussed in the maintenance section of this manual.

Home Screen

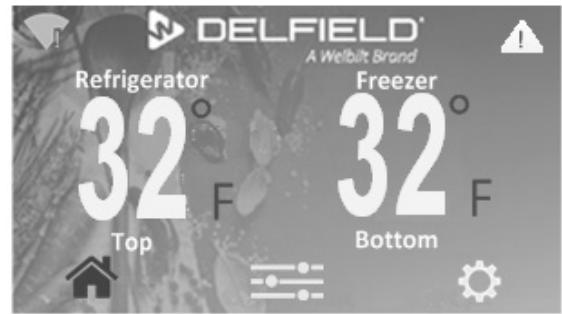

Dual Temperature Home Screen



Standard Home Screen

- Home screens display:
 - Cabinet temperature
 - Top left features an internet status icon.
 - Top right features an active alert icon. If there are active alarms touching it will display the Alarm History screen.
- At the bottom the active screen's icon will be displayed in blue.
 - Home screen icon
 - Configuration screen icon
 - Settings screen icon
 - Swipe to move between the screens or select the desired screen icon
- Most function screens will timeout after 15 seconds of inactivity and return to the home screen.

- If the unit is in defrost, the defrost icon replaces the cabinet temperature. The defrost icon will be displayed throughout the defrost process.



- If there is a cabinet temperature probe failure three dashes will replace the cabinet temperature. The active alert icon will also display. The three dashes will be displayed as long as the temperature probe failure continues.



- When the cabinet has been turned off and power is still connected, the power icon will replace the temperature. The display remains active for service functions and to turn the cabinet back on.



TouchScreen Password

1. When a function is password protected, the password enter screen will appear. Type in the either the manager password or the service password.
 - The icon ^ in the bottom left will toggle the keyboard between uppercase, lower case and numbers.
 - The manager password is 211276.



2. After the correct password is entered, the display will proceed to the password protected function.
 - All features protected by the entered password will remain active until the display is not active for 10 seconds. The display will return to the home screen and the password accessed features will be locked.
3. Three attempts are allowed with incorrect passwords then the touchscreen will return to the home screen.



Configuration Screen

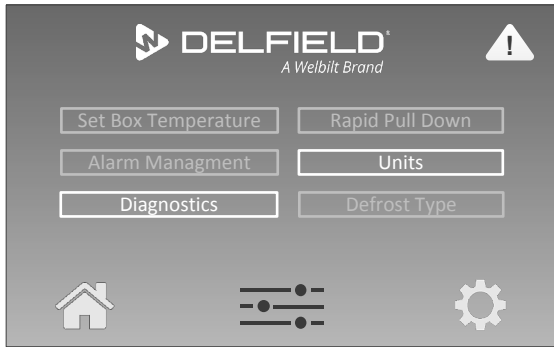

- The Configuration screen can be accessed by swiping horizontally from the Home or any top level screen.
- From the Configuration Screen the following screens are accessible:
 - Frame Heater (freezer only)
 - Rapid Pull Down (refrigerator only)
 - Units
 - Defrost Type (Refrigerator & Freezer)
 - Set Box Temperature
 - Alarm Management
 - Diagnostics
 - Network Connection
- Select the title frame to navigate there. The gray titles require a password to access.



Settings Screen



- The Settings screen can be accessed by swiping horizontally from the Home or any top level screen.
- From the Settings Screen the following screens are accessible:
 - Interior Light
 - Time / Date
 - Password
 - Language
 - LCD Brightness
 - Manual Defrost (Refrigerator & Freezer)
 - Firmware Update
 - Reset Factory Settings
 - Unit Standby
- Select the title frame to navigate there. The gray titles require a password to access.



- From the settings screen, the language button remains the fourth button down on the left regardless of language.



Units



Configuration Screen\Units

- The selected mode/button will be gray.
- Selecting Fahrenheit sets the cabinet temperature units to Fahrenheit. This is the factory default.

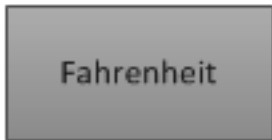

- Selecting Celsius sets the cabinet temperature units to Celsius.

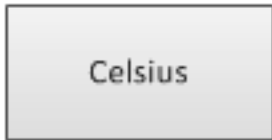

Defrost Type (Refrigerator & Freezer)



Configuration Screen\Defrost Type

- Access to this page requires the manager password.
- The selected mode/button will be gray.
- Selecting Adaptive Defrost activates this defrost mode. This is the factory default.

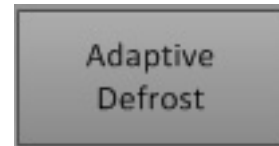

Adaptive Defrost

The temperature control monitors the evaporator temperature and will turn off the compressor and condenser fan motor when needed to allow accumulated frost on the evaporator to clear. Additionally the freezer evaporator fan will turn off and the defrost heater will switch on to warm the coil. During this defrost cycle, the control will display a defrost icon. After the defrost cycle is complete, the temperature control will return to a normal cooling cycle, but the defrost icon will continue on the display until the evaporator returns to normal cooling temperatures (up to 30 minutes). The freezer evaporator fan motor will not switch on until the evaporator reaches -5°F (-21°C) or two minutes AFTER the compressor and condenser fan motor have begun operating.



The temperature control monitors evaporator temperature and compressor run time to determine the proper time for a positive defrost cycle. A defrost cycle can occur as often as every 60 minutes under extremely heavy usage. It can last a minimum of 2 minutes in a refrigerator or 6 minutes in a freezer. The compressor will remain off until the evaporator coil temperature exceeds:

- 41°F (5°C) or the controller reaches a time limit of 75 minutes on a refrigerated unit.
- 55°F (13°C) or the controller reaches a time limit of 35 minutes on a freezer.

Time of Day Defrost

- Selecting Time of Day Defrost activates this defrost mode.

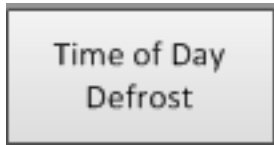

- Time of Day Defrost requires defrost times to be set up.

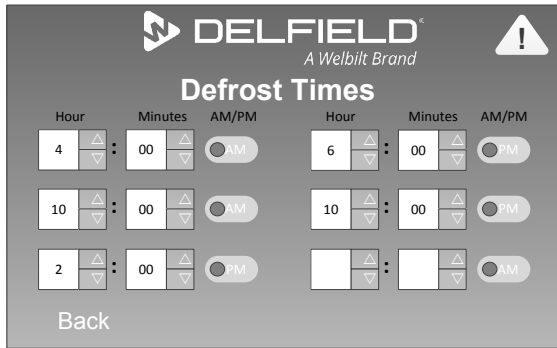

Configuration Screen\Defrost Type\Time of Day Defrost

- Six defrost times are allowed.
- A blank hour and minutes will be an inactive time.
- If no defrost times are assigned, no defrost will occur.
- Increase and decrease the defrost time settings using the up and down arrows.



- Hours 1 through 12 will be available if a 12 hour clock format has been selected on the Time/Date page. The AM/PM icon will allow you to switch between the two.



- Hours 1 through 23 will be available if a 24 hour clock format has been selected on the Time/Date page.
- Minutes can be set 00 through 59.

Set Box Temperature

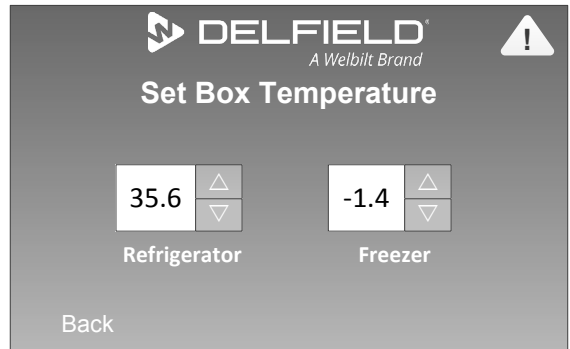

**Configuration Screen\Set Box Temperature
Screen For Dual Temperature Cabinet Shown**

- Access to this page requires the manager password.
- Increase and decrease the cabinet temperature set point using the up and down arrows.
- Set point can only be adjusted within the set point limits.
- Refrigeration factory setting is 35.6°F, set point limits are 30°F and 60°F.
- Freezer factory setting is -1.4°F, set point limits are -5°F and 36°F.
- Heated cabinet factory setting is 165°F, set point limits are 120°F and 200°F.



Alarm Management

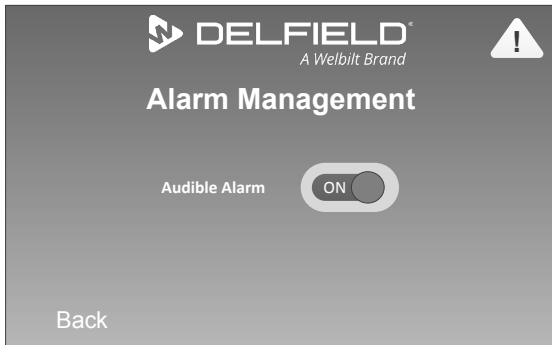

Configuration Screen\Alarm Management

- Access to this page requires the manager password.
- Selecting this Icon switches the audible alarm between Off and On. On is the factory setting.



Audible Alarm is Off



Audible Alarm is On

Network Connection

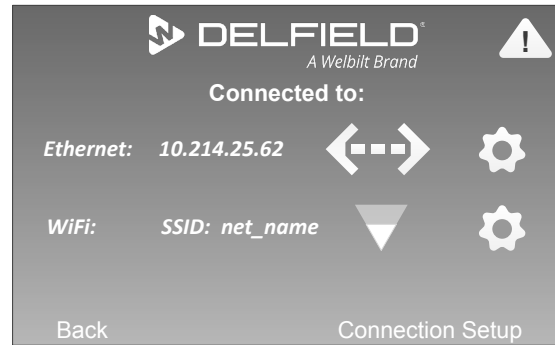

Configuration Screen\Network Connection

- Ethernet: will display local area network name and icon if it is connected.
- WiFi: will display the WiFi network name and signal strength if it is connected.
- Ethernet and WiFi both offer access to a IP Address Setup screen. Select the cog icon.



- Manage network connection by selecting Set Up Connection.



**Configuration Screen\Network Connection
\Set Up Connection**

- Screen will list up to eight networks, their name, type of security, and signal strength using an icon.
- Use the scroll bar on the right of the screen to see additional networks.

- Select a listed network and the display will navigate to the complete network setup.

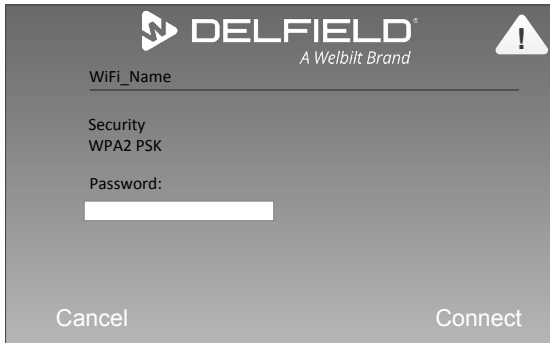

**Configuration Screen\Network Connection
\Set Up Connection\Network Name**

- Selecting cancel navigates to the previously viewed screen and cancels the network setup.



- Screen lists network name, type of security and empty password box.
- Select the empty password box to bring up a keyboard. Type in the password, each character will appear as an asterisk. Connect will appear in the lower right corner.



- If the incorrect password is entered the entry will disappear. Retry in the empty password box.
- If no password is required, security type will list None, neither password nor empty box will display and connect will appear in the lower right corner.
- Selecting Connect will complete the internet setup and navigate back to the Network Connection screen.

Interior Light

1. From the settings screen select Interior Lights.



Settings Screen\Interior Light

- The selected mode/button will be gray.
- Selecting Always Off switches the interior light to be off at all times.

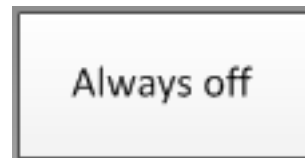

- Selecting Always On switches the interior light to be on at times when the unit is on. This is the factory default.

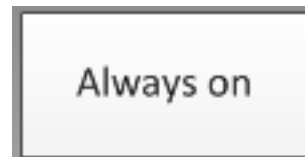

Time / Date

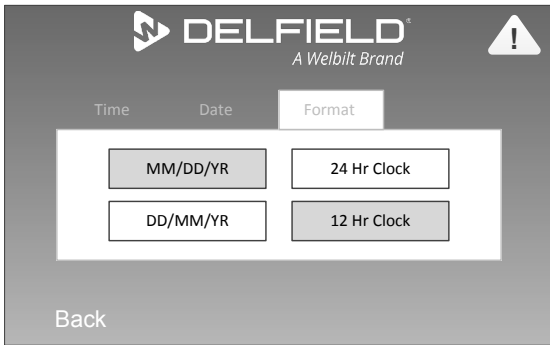

Settings Screen\Time|Date\Format Tab

- The Format Tab has two date and two time choices.
- Select the desired date and time format. The active choice will be gray.
- MM/DD/YR is the default. 12 Hr Clock is the default.



Date Format Choices



Time Format Choices

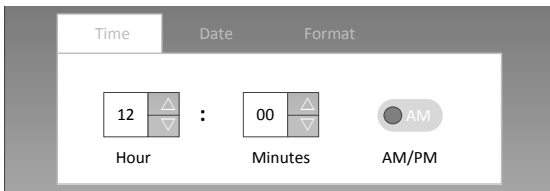

Settings Screen\Time|Date\Time Tab

- Increase and decrease the hour and minutes using the up and down arrows.
- Based on the clock format chosen the hours can be set through 12 or 24.
- Select the AM/PM icon to switch between the two. The icon will not be available if the 24 Hr Clock is selected.

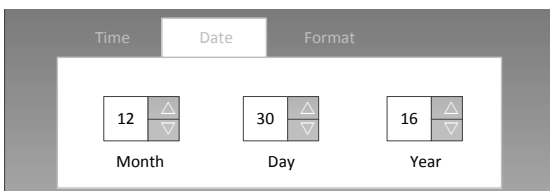

Settings Screen\Time|Date\Date Tab

- Increase and decrease the Month, Day and Year using the up and down arrows.
- 20 precedes the year setting.

Language

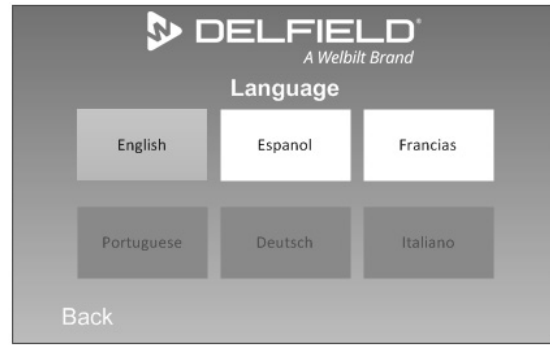

Settings Screen\Language

- Language in the light gray box is current selection. English is default.

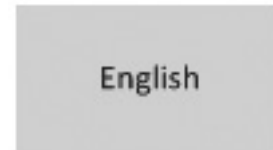

Selected Language in Blue

- Select a language in a white box to change.
- Languages in dark gray boxes are not yet available.
- English remains the top left button regardless of language.



LCD Brightness

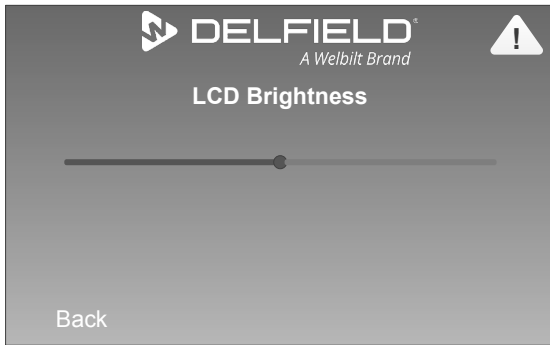

Settings Screen\LCD Brightness

- LCD default is 50%.
- Slide the small circle along the line to the right to increase the brightness, left to decrease.

NOTE: Adjusting brightness to 60% or less will increase the life of the display.



Manual Defrost



Settings Screen\Manual Defrost

- Access to this page requires the manager password.
- Off is the factory setting.
- When On is selected the defrost will cycle once and return to normal operation.



Web Application

KITCHENCONNECT

This online application is an equipment monitoring tool.

Register:

1. Navigate to <https://www.welbiltdigital.com/>
2. Select Register.
3. Enter Information in at least the required fields.
4. Select Submit.
5. Enter your email and password.
6. Select Login.

Mobile Application

SPECIFICATION LINE CONNECT

This mobile application is an equipment monitoring tool.

To Download The Mobile Application:

1. Open either Apple iTunes or Google PlayStore.
2. Search for Specification Line Connect.
3. Select and install.
4. Open the application. The Welbilt W logo is the application icon.



Application Operation

Set Up A Site

1. Select + Add Site. 
2. Fill in all site information. All fields are required.
 - Site ID (Max 30 Characters)
 - Site Name (Max 20 Characters)
 - Site Manager Name (Max 20 Characters)
 - Site Email ID (Max 50 Characters)
 - Site Address (Max 50 Characters)
 - Country (From a Menu)
 - State (From a Menu)
 - City (Max 20 Characters)
 - Postal Code (Max 10 Characters)

3. Select Choose Site Location to put a pin on the map.



4. Select Submit.

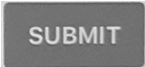

5. The new site will be added to the home page.

Edit Or Delete Site

1. Select the menu icon next to the site.
2. Edit and Delete Site are available actions.
3. Edit will bring up the site information page.
4. Delete will require confirmation.

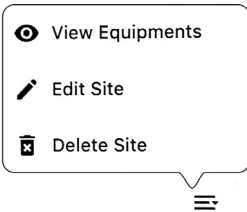

Set Up Equipment

1. Select the menu icon next to the site.
2. Select View Equipments.
3. Select + Add. 
4. Fill in all equipment information. All fields are required.

NOTE: Serial number entered must match equipment.

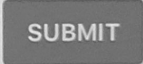
- Equipment Serial Number (Max 30 Characters)
 - Equipment Name (Max 20 Characters)
 - Equipment Type (From a Menu)
 - Equipment Model (From a Menu)
5. Select Submit. 

6. The new equipment will be connected to the site.

Edit Or Delete Equipment

1. Select the menu icon next to the equipment.
2. Edit and Delete Equipment are available actions.
3. Edit will bring up the equipment information page.
4. Delete will require confirmation.

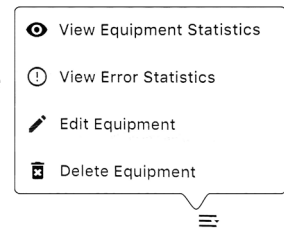

EQUIPMENT MANAGEMENT

View Equipment Statistics



Tabs include:

- Summary tab includes the following statistics:
 - Cavity1 Temp Max/Min
 - Cavity2 Temp Max/Min
 - Ambient Temp Max/Min
 - Energy Used
 - Network
 - Signal Strength
- Latest Temperature Information
- Set Point Vs Cavity Vs Ambient Temperature
- Condenser Inlet Vs Outlet Temperature
- Evaporator Inlet Vs Outlet Temperature
- Energy Usage

Change the date range by clicking the calendar icon.

If the site has multiple pieces of equipment you can switch to the other equipment from the equipment menu.

View Error Statistics

1. Select the menu icon next to the equipment.
2. View Error Statistics will bring up a list.
 - Change to a graph view by selecting the graph icon in the top right corner. 
 - Change the date range by clicking the calendar icon. 
 - If the site has multiple pieces of equipment you can switch to the other equipment from the equipment menu.

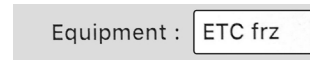

Section 4 Maintenance

⚠ DANGER

It is the responsibility of the equipment owner to perform a Personal Protective Equipment Hazard Assessment to ensure adequate protection during maintenance procedures.

⚠ DANGER

Failure to disconnect the power at the main power supply disconnect could result in serious injury or death. The power switch DOES NOT disconnect all incoming power.

⚠ DANGER

Disconnect electric power at the main power disconnect for all equipment being serviced. Observe correct polarity of incoming line voltage. Incorrect polarity can lead to erratic operation.

⚠ Warning

Never use sharp objects or tools to remove ice or frost. Do not use mechanical devices or other means to accelerate the defrosting process.

⚠ Warning

When cleaning interior and exterior of unit, care should be taken to avoid the front power switch and the rear power cord. Keep water and/or cleaning solutions away from these parts.

⚠ Warning

When using cleaning fluids or chemicals, rubber gloves and eye protection (and/or face shield) must be worn.

⚠ Caution

Maintenance and servicing work other than cleaning as described in this manual must be done by an authorized service personnel.

Notice

Never use a high-pressure water jet for cleaning or hose down or flood interior or exterior of units with water. Do not use power cleaning equipment, steel wool, scrapers or wire brushes on stainless steel or painted surfaces.

Responsibility

You are responsible for maintaining the equipment in accordance with the instructions in this manual. Maintenance procedures are not covered by the warranty.

Maintenance	Daily	Weekly	Monthly	After Prolonged Shutdown	At Start-Up
Interior	X			X	X
Gasket	X			X	X
Exterior	X			X	X
Drain		X		X	X
Condenser Coil			X	X	X

Interior Cleaning

The interior can be cleaned using soap and warm water. If this isn't sufficient, try ammonia and water or a nonabrasive liquid cleaner.

GASKETS

Gaskets require regular cleaning to prevent mold and mildew build up and also to retain the elasticity of the gasket. Clean them with water and mild soap (not citrus based). Avoid full strength cleaning products on gaskets as this can cause them to become brittle and crack. Never use sharp tools or knives to scrape or clean the gasket. Gaskets can be easily replaced and do not require the use of tools or an authorized service person. The gaskets are dart style and can be pulled out of the groove in the door. Place gasket in warm water to make the material more pliable for installation. Dry and press into place.

PREVENTING BLOWER COIL CORROSION

To help prevent corrosion of the blower coil, store all acidic items, such as pickles and tomatoes, in seal-able containers. Immediately wipe up all spills.

Exterior Cleaning

Notice

Never use an acid based cleaning solution on exterior panels! Many food products have an acidic content, which can deteriorate the finish. Be sure to clean the stainless steel surfaces of ALL food products.

Clean the area around the unit as often as necessary to maintain cleanliness and efficient operation.

Wipe exterior surfaces with a damp cloth rinsed in water to remove dust and dirt from the outside of the unit. Always rub with the "grain" of the stainless steel to avoid marring the finish. If a greasy residue persists, use a damp cloth rinsed in a mild dish soap and water solution. Wipe dry with a clean, soft cloth.

Never use steel wool or abrasive pads for cleaning. Never use chlorinated, citrus based or abrasive cleaners.

Stainless steel exterior panels have a clear coating that is stain resistant and easy to clean. Products containing abrasives will damage the coating and scratch the panels. Daily cleaning may be followed by an application of stainless steel cleaner which will eliminate water spotting and fingerprints. Early signs of stainless steel breakdown are small pits and cracks. If this has begun, clean thoroughly and start to apply stainless steel cleaners in attempt to restore the steel.

Wipe casters with a damp cloth to prevent corrosion.

DRAIN

Each refrigerated unit has a drain located inside the unit that removes the condensation from the evaporator coil and routes it to an external condensate evaporator pan. Each drain can become loose or disconnected during normal use. If you notice water accumulation on the inside of the unit, be sure the drain tube is connected to the evaporator drain pan. If water is collecting underneath the unit, make sure the end of the drain tube is in the condensate evaporator. The leveling of the unit is important as the units are designed to drain properly when level. Be sure all drain lines are free of obstructions.

DOORS/HINGES

Over time and with heavy-use doors, the hinges may become loose. If this happens, tighten the screws that mount the hinge brackets to the frame of the unit. Loose or sagging doors can cause the hinges to pull out of the frame, which may damage both the doors and the hinges. In some cases this may require qualified service agents or maintenance personnel to perform repairs.

Cleaning the Condenser Coil

In order to maintain proper refrigeration performance, the condenser fins must be cleaned of dust, dirt and grease regularly. It is recommended that this be done monthly. If conditions are such that the condenser is totally blocked in a month, the frequency of cleaning should be increased. Clean the condenser with a vacuum cleaner or stiff brush. If extremely dirty, a commercially available condenser cleaner may be required.

Failure to maintain a clean condenser coil can initially cause high temperatures and excessive run times. Continuous operation with a dirty or clogged condenser coil can result in compressor failure. Neglecting the condenser coil cleaning procedures will void any warranties associated with the compressor and cost to replace the compressor.

Section 5 Troubleshooting

Problem -> Cause -> Correction Chart

Problem	Cause	Correction
Cabinet not running	Fuse blown or circuit breaker tripped.	Replace fuse or reset circuit breaker.
	Power cord unplugged.	Plug in power cord.
	Thermostat set too high.	Set thermostat to lower temperature.
	System is off.	Turn system on.
	Cabinet in defrost cycle. (Refrigerator and Freezer models)	Wait for defrost cycle to finish.
Condensing unit runs for long periods or continuously	Excessive amount of warm product placed in cabinet.	Allow adequate time for product to cool down.
	Prolonged door openings or door(s) ajar.	Make sure door(s) are closed when not in use. Avoid prolonged door openings.
	Door gasket(s) not sealing properly.	Check gasket condition. Adjust door or replace gasket if necessary.
	Dirty condenser coil.	Clean the condenser coil.
	Evaporator coil iced over.	Turn unit off and allow coil to defrost. Make sure thermostat is not set too cold. Also, check gasket condition.
Cabinet temperature is too high	Thermostat set too high.	Set thermostat to lower temperature.
	Poor air circulation in cabinet.	Re-arrange product to allow proper air circulation.
	Excessive amount of warm product placed in cabinet.	Allow adequate time for product to cool down.
	Prolonged door openings or door(s) ajar.	Make sure door(s) are closed when not in use. Avoid prolonged door openings.
	Dirty condenser coil.	Clean the condenser coil.
	Evaporator coil iced over.	Turn unit off and allow coil to defrost. Make sure thermostat is not set too cold. Also, check gasket condition.
Cabinet is noisy	Loose part(s).	Locate and tighten loose part(s).
Refrigerator is freezing product	Thermostat is set too low.	Set thermostat to higher temperature.
	Dirty condenser coil.	Clean the condenser coil.
	Not enough cabinet clearance for proper refrigeration system operation.	Move cabinet or make other adjustments to gain proper cabinet clearances.
Compressor will not start	Low voltage to cabinet.	Check and correct incoming voltage to cabinet.

THIS PAGE INTENTIONALLY LEFT BLANK

Section 6 Control

Service Screens

Operator screens are covered in Section 3, Operation.
The manager password is 211276.

FRAME HEATER (FREEZER ONLY)

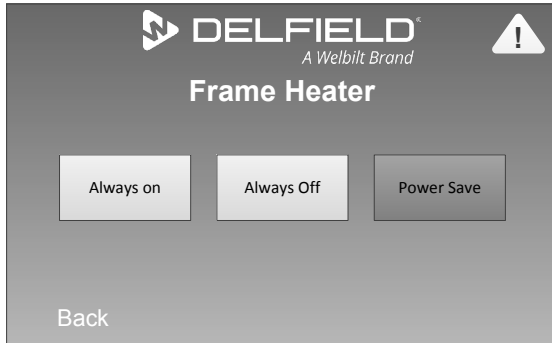

Configuration Screen\Frame Heater

- Access to this page requires the manager password.
- The selected mode/button will be gray.
- These buttons control the length of time that heat is applied to the door perimeter.
- Selecting the Always On icon switches the frame heater to be on at times when the unit is on. Use this mode if excessive condensation is observed on the door opening.

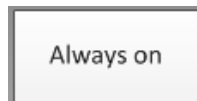

- Selecting the Always Off icon switches the frame heater to be off at all times.

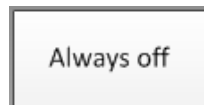

- Selecting the Power Save icon switches the frame heater to be on only when the compressor is on. Power save mode will use less energy than always on while occasionally heating the door to remove condensation. This is the factory default.

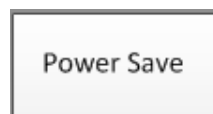

RAPID PULL DOWN (REFRIGERATOR ONLY)

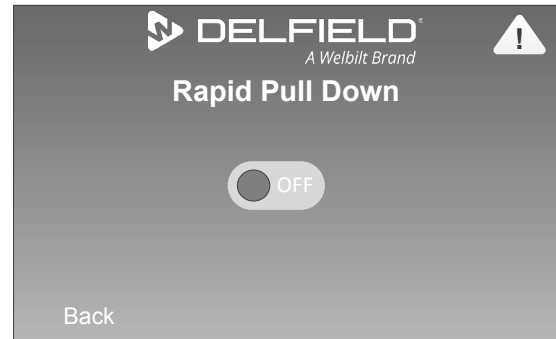

Configuration Screen\Rapid Pull Down

- Access to this page requires the manager password.
- When the rapid pull down is turned on the set point is lowered to 30°F for 60 minutes.
- It can be turned off any time during the 60 minutes of rapid pull down.
- Selecting this Icon switches the rapid pull down feature between Off and On.



Rapid Pull Down Feature is Off

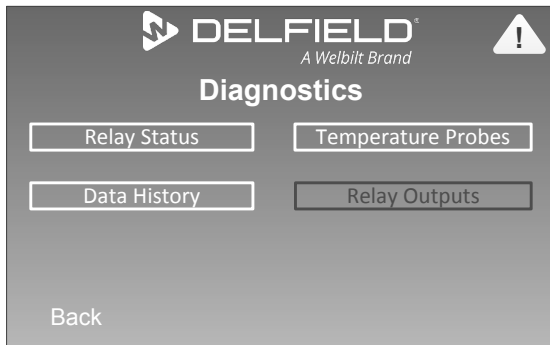

Rapid Pull Down Feature is On

DIAGNOSTICS**Configuration Screen\Diagnostics**

- From the Diagnostics Screen the following screens are accessible:
 - Relay Status
 - Data History
 - Temperature Probes
 - Relay Outputs
- Select the title frame to navigate there.

RELAY STATUS

- This screen is a list of relay's with their status to the right.
- The status displays either on or off.

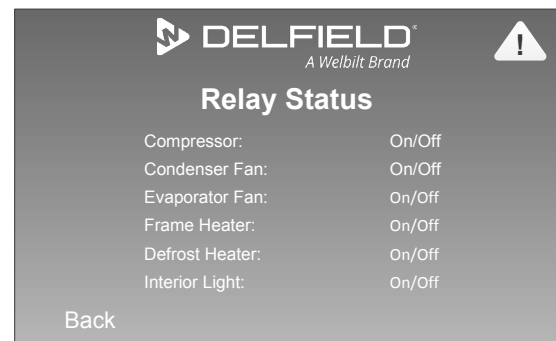
**Configuration Screen\Diagnostics\Relay Status**
Heated Unit**Configuration Screen\Diagnostics\Relay Status**
Freezer**Configuration Screen\Diagnostics\Relay Status**
1 Section Dual Temperature Unit

DATA HISTORY

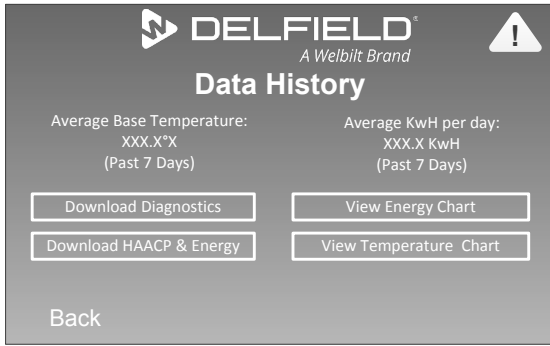

Configuration Screen\Diagnostics\Data History

- Average Cabinet Temperature for the past 7 days is displayed.

Average Base Temperature:
XXX.X°X
(Past 7 Days)

- Average energy use in Kwh per day for the past 7 days is displayed.

Average Kwh per day:
XXX.X Kwh
(Past 7 Days)

- From the Data History Screen the following screens are accessible:
 - View Energy Chart
 - View Temperature Chart
- Select the title frame to navigate there.
- Selecting a download title navigates to the Download data screens.

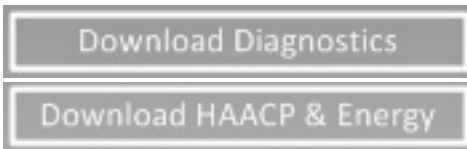

1. Insert USB memory device into USB port located bottom of the front shroud to the left of the control display. Skip this if updating via wireless.
2. Touch start button to begin download.



3. Do not remove device until prompted.
4. Select Back to return to return to home screen.
5. Remove USB device memory device if used.

ENERGY CHART

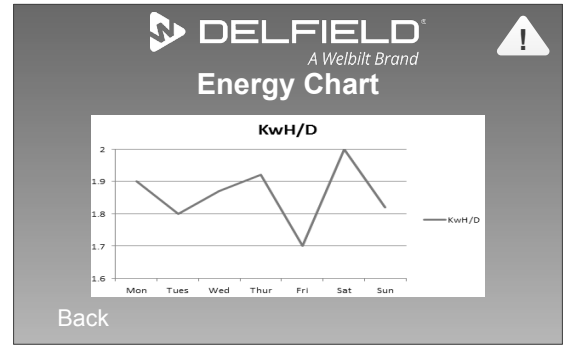

Configuration Screen\Diagnostics\Data History\Energy Chart

- Graph of energy usage in Kwh per day over the past seven days.

TEMPERATURE CHART

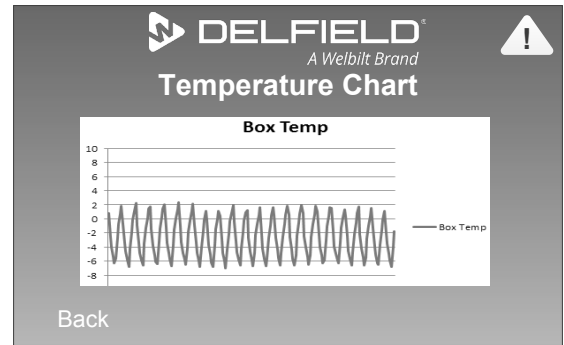

Configuration Screen\Diagnostics\Data History\Temperature Chart

- Graph of cabinet temperature per day over the past seven days.
- Two temperature screens will be available for dual temperature units. Use the next icon to navigate to the second screen.



TEMPERATURE PROBES

- This screen is a list of temperature probes with their current value.

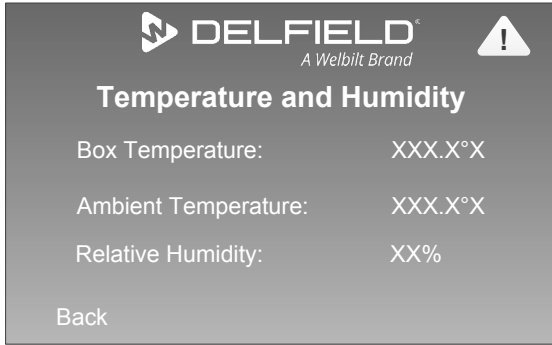

**Configuration Screen\Diagnostics\Temperature Probes
Heated Unit**

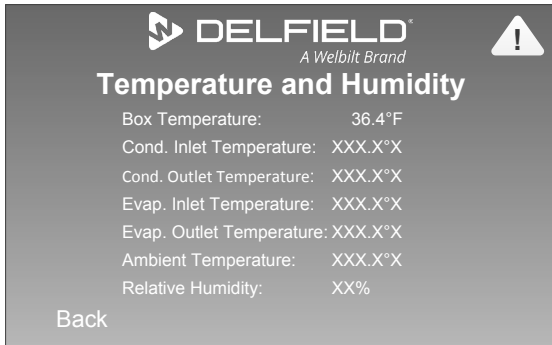

**Configuration Screen\Diagnostics\Temperature Probes
1 Section Dual Temperature Unit**

RELAY OUTPUTS

- Access to this page requires the service password.
- This screen lists the relays available for a service person to energize.
- Selecting the Press to Activate icon will energize the relay for 5 seconds.



- Only one relay can be activated at a time.
- During the 5 second energize period the icon will be green and read, Relay Activated.

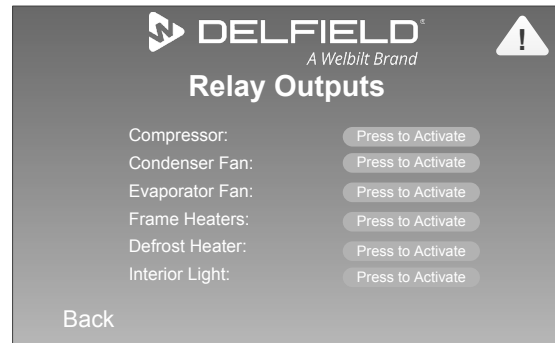

**Configuration Screen\Diagnostics\Relay Outputs
Freezer**



**Configuration Screen\Diagnostics\Relay Outputs
1 Section Dual Temperature Unit**

NETWORK CONNECTION

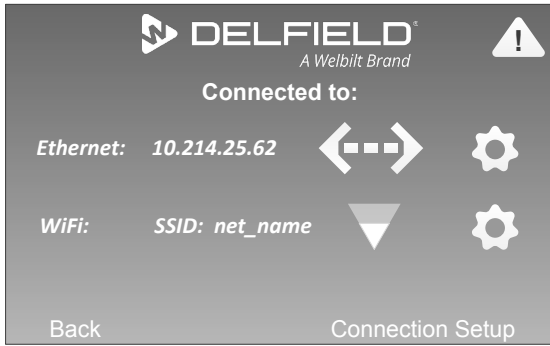

Configuration Screen\Network Connection

- Ethernet: will display local area network name and icon if it is connected.
- WiFi: will display the WiFi network name and signal strength if it is connected.
- Ethernet and WiFi both offer access to a IP Address Setup screen. Select the cog icon.



- Manage the networks by selecting Set Up Connection.



SET UP CONNECTION

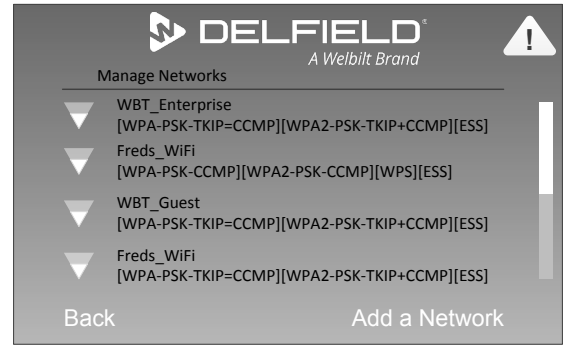

Configuration Screen\Network Connection \Set Up Connection

- Screen will list up to eight networks, their name, type of security, and signal strength using an icon.
- Use the scroll bar on the right of the screen to see additional networks.
- Select a listed network and the display will navigate to the complete that network's setup.
- Select the words on the screen to add a network.



COMPLETE NETWORK SETUP
**Configuration Screen\Network Connection
\Set Up Connection\Network Name**

- Selecting cancel navigates to the previously viewed screen and cancels the network setup.

Cancel

- Screen lists network name, type of security and empty password box.
- Select the empty password box to bring up a keyboard. Type in the password, each character will appear as an asterisk. Connect will appear in the lower right corner.

Connect

- If the incorrect password is entered the entry will disappear. Retry in the empty password box.
- If no password is required, security type will list None, neither password nor empty box will display and connect will appear in the lower right corner.
- Selecting Connect will complete the internet setup and navigate back to the Network Connection screen.

ADD A NETWORK SCREEN
**Configuration Screen\Network Connection
\Set Up Connection\Add a Network**

- Selecting cancel navigates to the previously viewed screen and cancels adding the network.
- Fill in the network name. Select the empty box to bring up a keyboard.
- The security pulldown menu will have the following options. Select by touching the type.
 - No authentication (open)
 - WEP
 - WPA2-Personal
 - WPA-Personal
 - WPA2-Enterprise
 - WPA-Enterprise
- The encryption pulldown menu will have different options depending on the security chose. The full list of options are below. Select by touching the type.
 - None
 - WEP
 - AES
 - TKIP
- Select the empty Security Key box to bring up a keyboard. Type in the pasword, each character will appear as an asterisk.
- If network is No authentication (open), the Security Key box will be grayed out and not functional.
- Select or deselect the start the connection automatically box.
- Select or deselect the connect even if the network is not broadcasting box.
- Selecting Connect will complete the network setup and navigate back to the Network Connection screen.
- If the network does not properly setup, the Add A Network Screen will stay active.

IP ADDRESS SETUP SCREEN

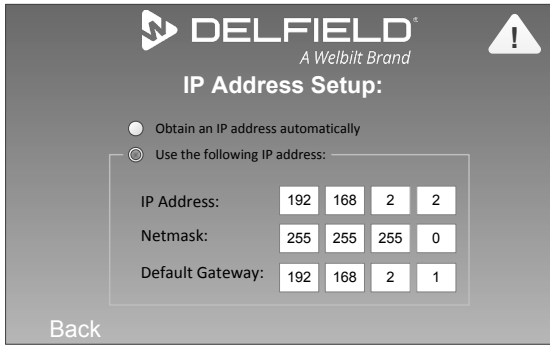

Configuration Screen\Network Connection\Cog Icon

- Selecting back navigates to the previously viewed screen and activates any values that were changed.
- Select Obtain an IP address automatically or select Use the following IP address. The feature that is active will have a circle that looks full.
- If Obtain an IP automatically is selected the majority of the screen will be inactive. The IP address will change every time the unit is powered up.
- If Use the following IP address is selected continue to fill in the screen, IP address, Netmask and Default Gateway.
 - Touching any of the boxes will bring up a numeric keypad.
 - Each white box can contain up to three digits, a number between 0 and 255.

PASSWORD

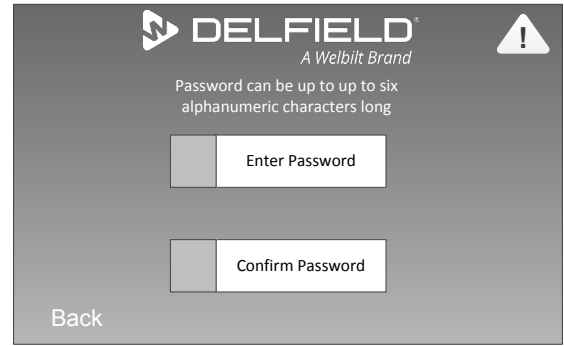

Settings Screen>Password

- Access to this page requires the manager password.
- Selecting the Enter Password icon will open the keyboard. Enter new password; it can be up to six letters and numbers.



- Select the Confirm Password icon will open the keyboard. Confirm the new password.



- If the passwords do not match they will need to be reentered.

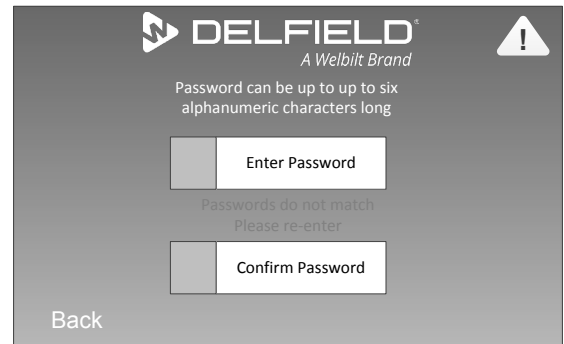

FIRMWARE UPDATE



Settings Screen\Firmware Update With Manager Password

- Access to this page requires the manager password.
- 1. Insert USB memory device into USB port located on bottom of the front shroud to the left of the control display. Skip this if updating via wireless.
- 2. Touch start button to begin download.



Firmware Updating In Process Screen

- 3. Do not remove device until prompted.



Firmware Update Complete Screen

- 4. Remove USB device memory device if used.

Check Firmware Version with Firmware Update Screen

From the Settings Screen, select Firmware Update.

Instead of using the manager password, use the service password, 9014766419.

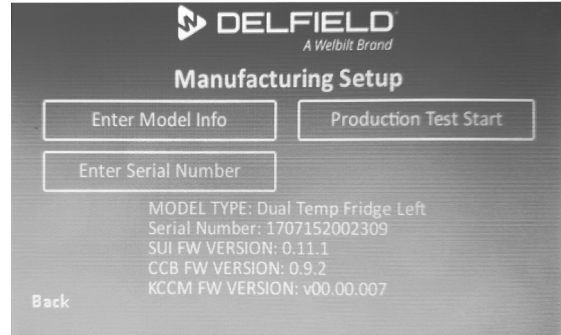

Settings Screen\Firmware Update With Service Password

RESET FACTORY SETTINGS



Settings Screen\Reset Factory Settings

- Access to this page requires the manager password.
- Selecting OK will reset all setting to factory default settings, passwords included.



- Selecting Cancel, cancels the reset and navigate the display back to the home screen.



ALARM HISTORY SCREEN

- Home screen Top right features an active alert icon.
- Touch it to display the Alarm History screen.

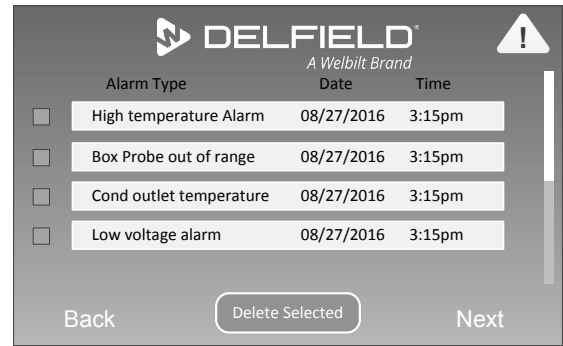

Alarm History Screen

- Control will store up to 20 messages.
- Use the next button or the scroll bar on the right of the screen to see additional alarms.
- Alarm information includes type, date and time.
- Types include:
 - High Temperature Alarm
 - Low Temperature Alarm
 - High Voltage Alarm
 - Low Voltage Alarm
 - Open Door Alarm
 - Sensor Alarm
 - Box Probe
 - Evap Outlet Probe
 - Continuous Compressor Run
 - Condenser Temperature too high
 - Maintenance Alert
 - Loss of Power
 - Power Restored
- Select a gray box to put an X in it or to remove the X.



- Delete Selected will delete all the messages with an X in their gray box.



ALARM SCREENS

- From the Home screen select the active alert icon to go to the Alarm History screen. 
- Select the alarm type to navigate to the alarm screen.



 Alarm History Screen\High Temperature Alarm



 Alarm History Screen\Low Temperature Alarm

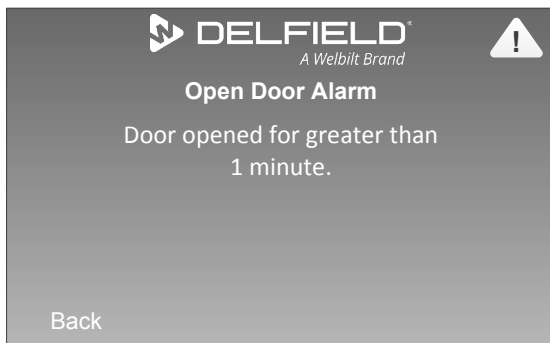

 Alarm History Screen\Open Door Alarm



 Alarm History Screen\Sensor Alarm



 Alarm History Screen\Box Temperature Probe Error

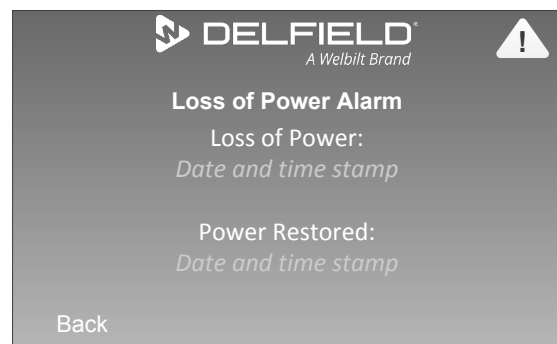

 Alarm History Screen\Loss Of Power Alarm

REFRIGERATOR & FREEZER ALARMS



The screen displays the Delfield logo and a warning icon. The title is "High Voltage Alarm". The text reads: "Compressor did not start or shut down due to voltage exceeding acceptable limits." A "Back" button is at the bottom left.

Alarm History Screen\High Voltage Alarm



The screen displays the Delfield logo and a warning icon. The title is "Continuous Compressor Run Alarm". The text reads: "Compressor ran continuously for an extended period of time. Contact KitchenCare 844-724-CARE (2273)". A "Back" button is at the bottom left.

Alarm History Screen\Continuous Compressor Run Screen



The screen displays the Delfield logo and a warning icon. The title is "Low Voltage Alarm". The text reads: "Compressor did not start or shut down due to voltage below acceptable limits." A "Back" button is at the bottom left.

Alarm History Screen\Low Voltage Alarm



The screen displays the Delfield logo and a warning icon. The title is "Condenser Temperature Alarm:". The text reads: "Condenser temperature too high. Possible blocked coil. Refer to owners manual for instructions to clean the coil or contact KitchenCare 844-724-CARE (2273)". A "Back" button is at the bottom left.

Alarm History Screen\Condenser Temperature Too High



The screen displays the Delfield logo and a warning icon. The title is "Evaporator Outlet Probe Error". The text reads: "Defrost operating in Safe Mode. Call KitchenCare immediately. 844-724-CARE (2273)". A "Back" button is at the bottom left.

Alarm History Screen\Evaporator Outlet Temperature Probe Error



The screen displays the Delfield logo and a warning icon. The title is "Maintenance Alert: Clean Condensing coil". The text reads: "Clean condensing coil ASAP. Refer to owners manual for instructions to clean the coil." A "Back" button is at the bottom left.

Alarm History Screen\Maintenance Alert

THIS PAGE INTENTIONALLY LEFT BLANK

Section 7

Component Check Procedures

Evaporator Fan Access

- Evaporator fan wiring connections are accessed from the top through the evaporator box lid.
- Access the evaporator fans inside the cabinet through the air baffle in the interior top.

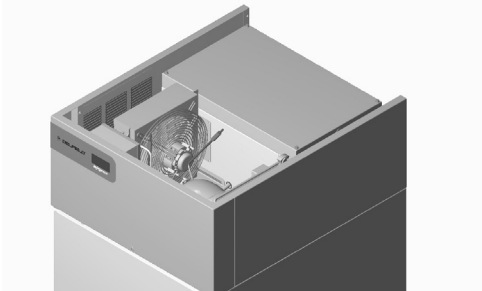

Evaporator box lid

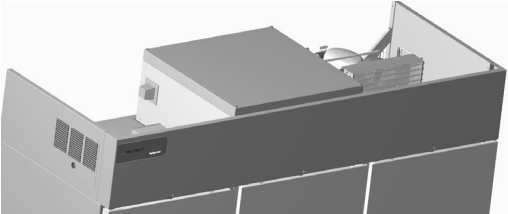

Evaporator box lid

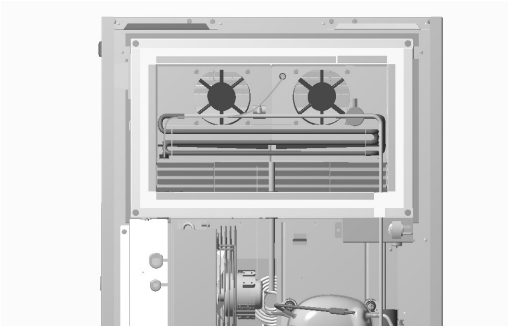

View with box lid removed for access to fan wiring connections

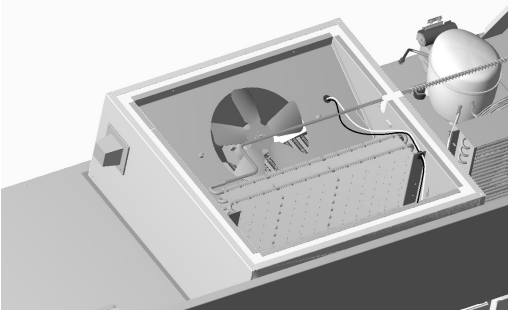

View with box lid removed for access to fan wiring connections

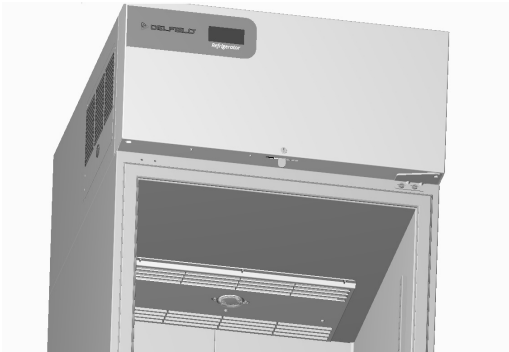

Interior view of air baffle

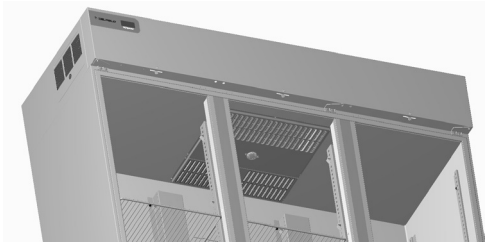

Interior view of air baffle

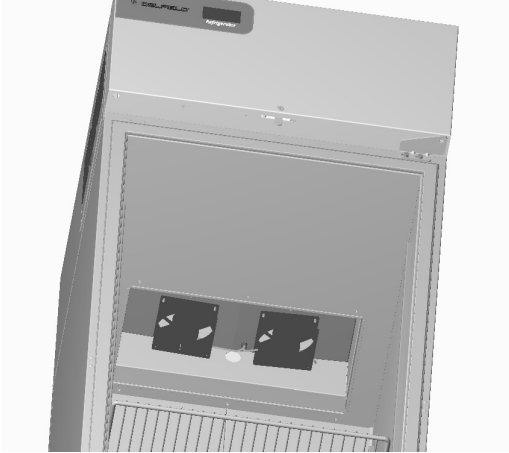

View with air baffle removed for access to evaporator fans

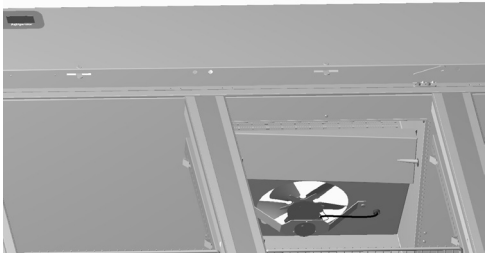

View with air baffle removed for access to evaporator fans

Condenser Fan Access

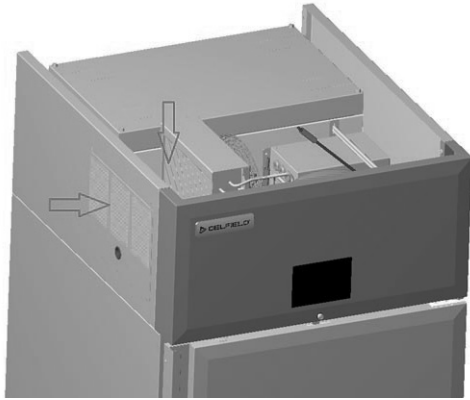

One Section Cabinets

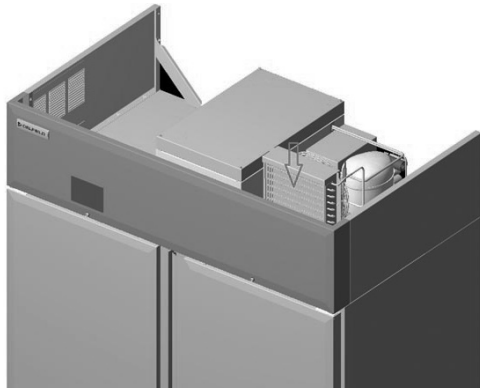

Two & Three Section Cabinets

Unit Air Flow Design

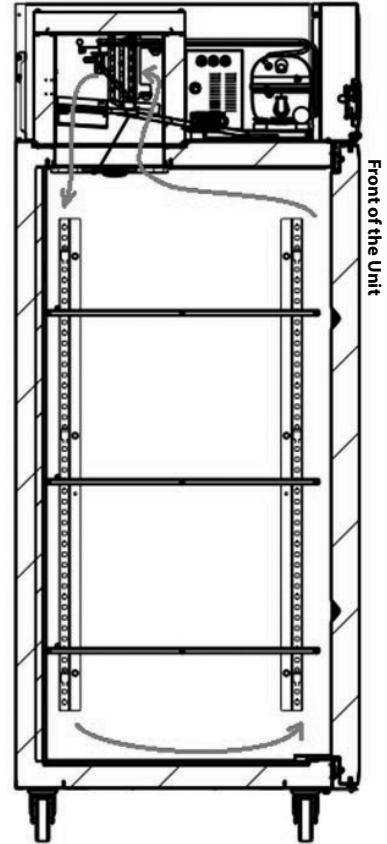

**Refrigerator/Freezer Cross Section
With Air Flow Arrows**

Frame Heater Routing

Full door units have only a perimeter heater wire.

Half door units have perimeter heater wires and horizontal mullion heater wires.

- Each end of a heater wire connects to a harness.
- The connections should be made above the cabinet.
- Heater wires should be fed in from the top of the cabinet.
- There should be no wiring connections made inside the extrusions behind the stainless steel gasket channels.



1 Section Full Door Freezer

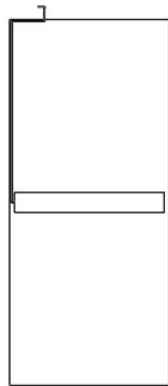

1 Section Half Door Freezer

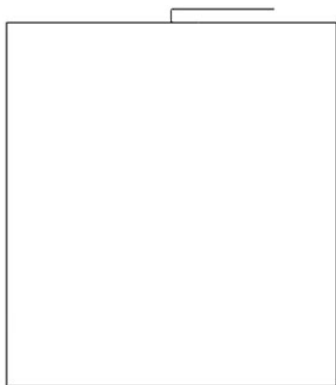

2 Section Full Door Freezer

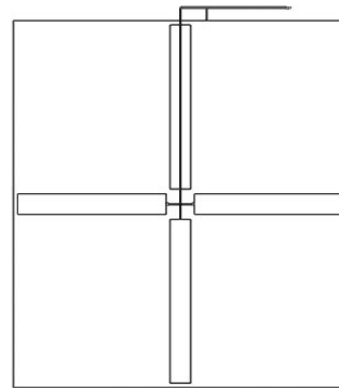

2 Section Half Door Freezer

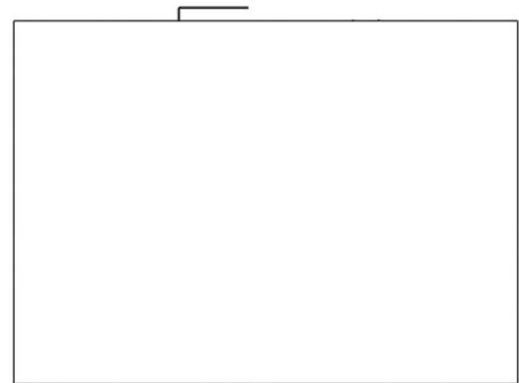

3 Section Full Door Freezer

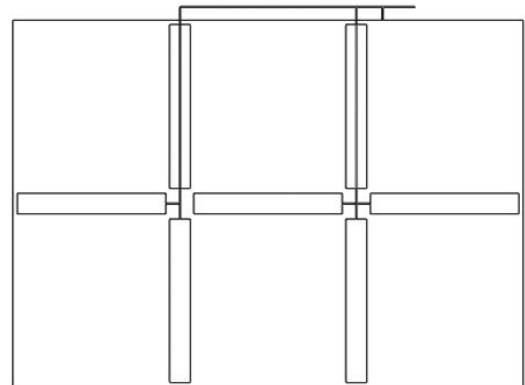

3 Section Half Door Freezer

Door Hinges

1. With a 3/8" nut driver remove the nuts and bottom hinge from the unit.



2. Remove door from unit.
3. Remove two screws from the bottom of the door to replace the hinge cartridge.



4. Place a white spacer on the bottom hinge pin.



5. Place the hinge on the hinge pin, rotate it and ensure there is tension in both directions.



- Rotate the door hinge 160°-180°.



- Hold the hinge, twist the door and slide the top pin into the top hinge.
- Screw the bottom hinge to the unit.



- Check the door alignment. Check that it shuts and seals. Adjust the bottom hinge if necessary.

Temperature Probe Resistance

Part 2195702	5KΩ NTC Temperature Probe	
Temperature in °C	Temperature in °F	Resistance (Ω) Nominal
-20	-4	48,560
-19	-2.2	45,835
-18	-0.4	43,275
-17	1.4	40,870
-16	3.2	38,610
-15	5	36,490
-2	28.4	18,100
-1	30.2	17,190
**0	32	16,330
1	33.8	15,520
2	35.6	14,755
3	37.4	14,030
4	39.2	13,345
5	41	12,700
20	68	6,245
21	69.8	5,970
22	71.6	5,710
23	73.4	5,460
24	75.2	5,225
25	77	5,000

** Resistance if probe is placed in an ice bath.

LED Light Replacement

Important Notes

- Tools Required: **T6 Torx Bit** & Phillips Head screwdriver
- **Keep track of the light cover, all screws and wires. They will be reused.**

Removal

1. Unscrew the light fixture from the unit.



Two (2) Screws Secure the Light in the Unit

2. Unscrew the light from the cover with the T6 torx bit.

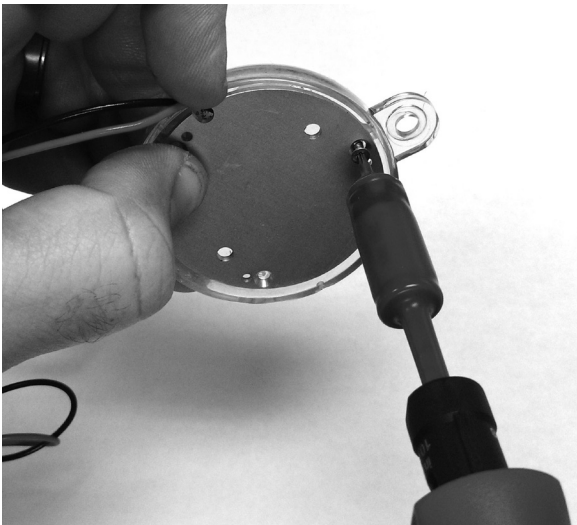

Four (4) Screws Secure the Light Cover On

3. Press the center of a raised tab to release the wire. Remove the wire. Repeat on second tab for second wire.

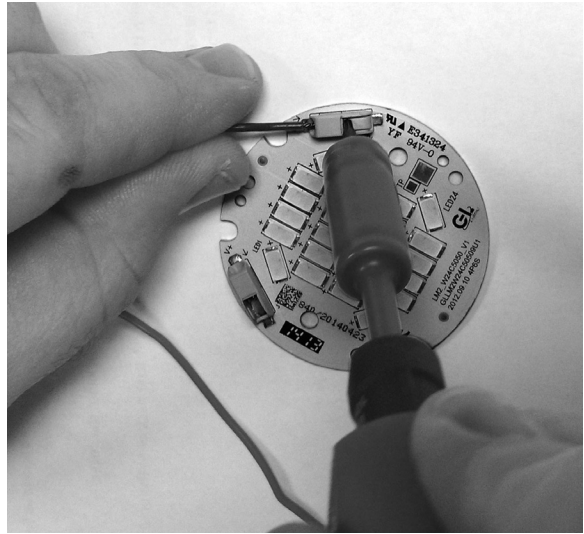

Pressing the Center of the Raised Tab Releases the Wire

4. Discard the old light.

Reinstall

5. Press the center of a raised tab and insert a wire. Repeat on second tab with second wire. The wires are interchangeable.
6. Screw the cover back on the light.
7. Screw the light fixture back into the unit.

Door Gasket

Upright units have a bullet- type push on gasket.



THIS PAGE INTENTIONALLY LEFT BLANK

Section 8

Refrigeration

R290

Important

We assume no responsibility for the use of contaminated refrigerant. Damage resulting from the use of contaminated refrigerant is the sole responsibility of the servicing company.

Connections

1. Suction side of the compressor through the suction service valve.
2. Discharge side of the compressor through the discharge service valve.

Charging Procedures

Important

The charge is critical on all Reach-In units. Use a scale or a charging cylinder to ensure the proper charge is installed.

1. Disconnect power to the unit.
2. Close the vacuum pump valve, the low side service valve, and the low side manifold gauge valve.
3. Open the high side manifold gauge valve and the high side service valve.
4. Open the charging cylinder and add the proper refrigerant charge (shown on nameplate) through the discharge service valve.
5. Let the system "settle" for 2 to 3 minutes.
6. Connect power up the unit.
7. Close the high side valve on the manifold gauge set. Add any remaining vapor charge through the suction service valve (if necessary).

NOTE: Manifold gauges must be removed properly to ensure that no refrigerant contamination or loss occurs.

8. Make sure that all the vapor in the charging hoses is drawn into the Reach-In before disconnecting the charging hoses.
 - A. Run the Reach-In cooling mode.
 - B. Close the high side service valve at the Reach-In.
 - C. Open the low side service valve at the Reach-In.
 - D. Open the high and low side valves on the manifold gauge set. Any refrigerant in the lines will be pulled into the low side of the system.
 - E. Allow the pressures to equalize while the Reach-In is running.
 - F. Close the low side service valve at the Reach-In.
 - G. Remove the hoses from the Reach-In and install the caps.

System Contamination Clean-up

This section describes the basic requirements for restoring contaminated systems to reliable service.

Important

We assume no responsibility for the use of contaminated refrigerant. Damage resulting from the use of contaminated refrigerant is the sole responsibility of the servicing company.

Determining Severity Of Contamination

Either moisture or residue generally causes system contamination from compressor burnout entering the refrigeration system.

Inspection of the refrigerant usually provides the first indication of system contamination. Obvious moisture or an acrid odor in the refrigerant indicates contamination.

If either condition is found, or if contamination is suspected, use a Total Test Kit from Totaline or a similar diagnostic tool. Follow the manufacturer's directions. These devices sample refrigerant, eliminating the need to take an oil sample.

If a refrigerant test kit indicates harmful levels of contamination, or if a test kit is not available, inspect the compressor oil.

1. Remove the refrigerant charge from the Reach-In.
2. Remove the compressor from the system.
3. Check the odor and appearance of the oil.
4. Inspect the suction and discharge lines at the compressor for burnout deposits.
5. If no signs of contamination are present, perform an acid oil test.

Check the chart below to determine the type of cleanup required.

Contamination/Clean-up Chart	
Symptoms/Findings	Required Cleanup Procedure
No Symptoms or suspicion of contamination	Normal evacuation/recharging procedure
Moisture/Air Contamination symptoms <ul style="list-style-type: none"> • Refrigeration system open to atmosphere for prolonged periods • Refrigeration test kit and/or acid oil test shows contamination <ul style="list-style-type: none"> • Leak in water-cooled condenser • No burnout deposits in open compressor lines 	Mild contamination clean-up procedure
Mild Compressor Burnout symptoms <ul style="list-style-type: none"> • Oil appears clean but smells acrid • Refrigeration test kit or acid oil test shows harmful acid content <ul style="list-style-type: none"> • No burnout deposits in open compressor lines 	Mild contamination clean-up procedure
Severe Compressor Burnout symptoms <ul style="list-style-type: none"> • Oil is discolored and smells acrid • Refrigeration test kit or acid oil test shows harmful acid content • Burnout deposits found in the compressor and lines, and in other components 	Severe contamination clean-up procedure

Mild System Contamination Clean-Up Procedure

1. Replace any failed components.
2. If the compressor is good, change the oil.
3. Replace the liquid line drier.

NOTE: If the contamination is from moisture, use heat lamps during evacuation. Position them at the compressor, condenser and evaporator prior to evacuation.

Important

Dry nitrogen is recommended for this procedure. This will prevent CFC release.

4. Follow the normal evacuation procedure, except replace the evacuation step with the following:
 - A. Pull vacuum to 1000 microns. Break the vacuum with dry nitrogen and sweep the system. Pressurize to a minimum of 5 PSI.
 - B. Pull vacuum to 500 microns. Break the vacuum with dry nitrogen and sweep the system. Pressurize to a minimum of 5 PSI.
 - C. Change the vacuum pump oil.
 - D. Pull vacuum to 250 microns. Run the vacuum pump for ½ hour on self-contained models, 1 hour on remotes.

NOTE: You may perform a standing vacuum test to make a preliminary leak check. You should use an electronic leak detector after system charging to be sure there are no leaks.

5. Charge the system with the proper refrigerant to the nameplate charge.
6. Operate the Reach-In unit.

Severe System Contamination Clean-Up Procedure

1. Remove the refrigerant charge.
2. Remove the compressor.
3. Remove the liquid line drier.
4. Replace the capillary tube.
5. Wipe away any burnout deposits from suction and discharge lines at compressor.
6. Sweep through the open system with dry nitrogen.

Important

Refrigerant sweeps are not recommended, as they release CFC's into the atmosphere.

7. Install a new compressor and new start components.
8. Install a suction line filter-drier (with acid and moisture removal capability) of adequate size. Place the filter drier as close to the compressor as possible.
9. Install inlet and outlet access valves.
10. Install a new liquid line drier.
11. Follow the normal evacuation procedure, except replace the evacuation step with the following:
 - A. a) Pull vacuum to 1000 microns. Break the vacuum with dry nitrogen and sweep the system. Pressurize to a minimum of 5 PSI.
 - B. Change the vacuum pump oil.
 - C. Pull vacuum to 500 microns. Break the vacuum with dry nitrogen and sweep the system. Pressurize to a minimum of 5 PSI.
 - D. Change the vacuum pump oil.
 - E. Pull vacuum to 250 microns. Run the vacuum pump for ½ hour on self-contained models, 1 hour on remotes.

NOTE: You may perform a standing vacuum test to make a preliminary leak check. You should use an electronic leak detector after system charging to be sure there are no leaks.

12. Charge the system with the proper refrigerant to the nameplate charge.
13. Operate the Reach-In unit for one hour. Then check the pressure drop across the suction line filter-drier.
 - A. If the pressure drop is less than 1 PSI, the filter-drier should be adequate for complete clean up.
 - B. If the pressure drop exceeds 1 PSI, change the suction line filter-drier and the liquid line drier.

Repeat steps 8 through 13 until the pressure drop is acceptable.

14. Operate the Reach-In unit for 48-72 hours. Then remove the suction line filter-drier and change the liquid line drier.
15. Follow normal evacuation procedures.

Filter Driers

The size of the filter-drier is important. Using an improperly sized filter-drier will cause the Reach-In unit to be improperly charged with refrigerant. OEM driers must be used.

Important

Driers are covered as a warranty part. Driers must be replaced any time the system is opened for repairs.

Refrigerant Re-Use Policy

We recommend the use of:

1. New Refrigerant
 - Must be of original nameplate type.

Properties of R-290 (Propane)

- R-290 is an alternative (not drop in replacement) for most commonly used refrigerants
- Special care has to be taken with R-290 because of the flammability of propane
- R-290 (propane) units are equipped with a yellow warning label



Avoiding Ignition

- Make sure the capacitors are discharged
- Use caution when working on “live” electrical components and wiring
- Make sure the unit is grounded and the ground does not break
- Ensure that the casings on electrical components are not cracked or broken when charging or recovering refrigerant
- Replace components with factory specified components. Other components could result in ignition of refrigerant in the ambient from a leak

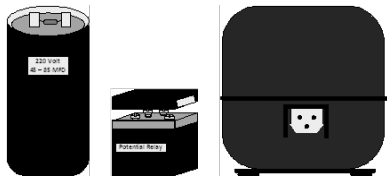

General Safety Precautions When Working With R-290

- Technicians must be instructed on the correct service procedures with R-290
- Working within confined spaces should be avoided
- No flammable materials are stored in the work area
- No ignition sources are present anywhere in the 35' work area
- Fire extinguishing equipment is available within the immediate area
- The work area is properly ventilated before working on the equipment
- Gas detectors should be present and operating to warn workers of concentrations of flammable refrigerants
- Only refrigerant handling and other service equipment designed for use with flammable refrigerants should be used when working on R-290 systems

Sources of Ignition & Avoiding Ignition

Sparks

Electrical terminals including capacitor terminals must be tightened and secured against loosening. Wires must be insulated to prevent shorting and sparking. Electrical motors must be brush-less.

Open Flames

- R-290 equipment should be positioned at a safe distance from open flames
- R-290 equipment should be positioned so that there is always good air gaps around all sides of the equipment
- R-290 equipment should be installed in a well ventilated space

Hot Surfaces

R-290 equipment should be installed where leaked refrigerant will not be exposed to any surfaces exceeding 842°F (auto-ignition temperature).

90% air / 10% propane mixture is required for ignition

Service Procedures

- Always use gas detection equipment when working on R-290 systems
- Set the alarm to 15% of the LFL (Lower Flammability Level)
- Make sure all ignition sources are removed from the work area
- Maintain a 35' area work area free of any ignition source
- Flames, sparks, and static electricity can ignite leaking refrigerant
- Always reclaim and purge system (twice) before using torch on system
- Always run the unit a minimum of 5 minutes before reclaiming refrigerant
- Follow evacuation (500 microns minimum) & purging procedures

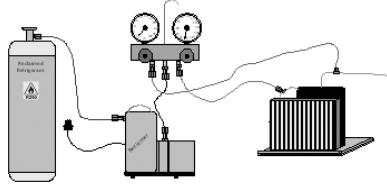

Passive recovery

Charging with R-290

- Charging with R-290 is similar to charging systems with hydrocarbons
- Like all blend refrigerants, R-290 systems must be charged with liquid to maintain correct composition of the blend

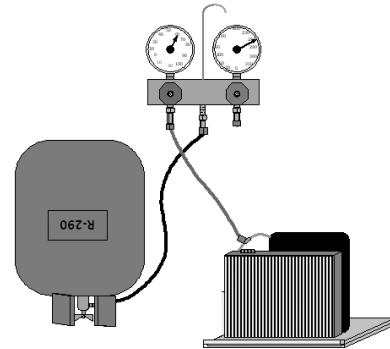

- Be sure that the unit is grounded before charging

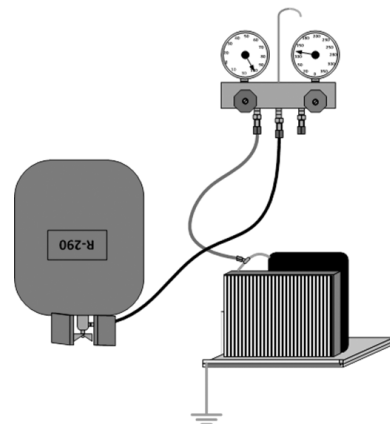

- It is very important to take care NOT to overfill the system
- Hydrocarbon charge sizes are typically 40% to 50% less than that of fluorocarbons

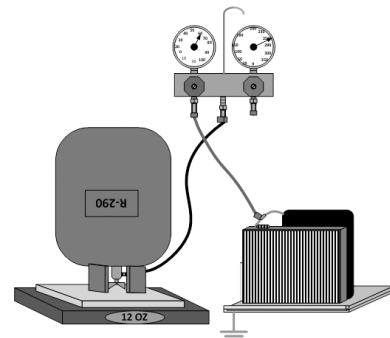

Service Procedures

- Lokring fittings should be used to seal refrigeration lines on R-290 systems.
- Tool part numbers and quantities of Lokring parts necessary to service R-290 systems are as follows:

Qty	Part #	Description	Notes
1	L13003829	Hand tool with double hinge handles	
2	L20000200	Assembly Jaw-Hand Tool MB8	
1	L14000878	Lok Prep 15ml	Good for 1 yr.
12	L13000766	Brass end caps .25	Use 2 per cap

Phone numbers to order parts: PA. 800-304-0153 and FL. 877-861-0955

To purchase from other vendors reference # WX5X1 for Lokring tool.



Review

- It's advisable to use portable gas detectors when working on R-290 units
- Before soldering on a R-290 system technicians should evacuate and purged with nitrogen twice
- Maximum allowable non-condensable in a R-290 system is 1%
- Evacuate the unit to a minimum of 500 microns before charging
- Bubble leak test or gas detection leak testing are the two preferred methods
- R-290 should be charged in the liquid state
- R-290 charges are typically 40% to 50% that of fluorocarbon refrigerants
- R-290 operating pressures compare to that of R-22
- Be sure to ground the unit before servicing refrigeration system
- Operate the condensing unit for a minimum of 5 minutes before evacuating to allow oil and refrigerant to separate
- Propane detectors should always be used when servicing R-290 equipment
- Reclaim and purge system twice before servicing unit
- Always cut components and fittings out of system – never use a torch to remove components
- Never leave any type of access fittings on R-290 system – always permanently seal the system

Normal Operating Temperatures

1 SECTION REACH-IN REFRIGERATOR

75°F (24°C) Ambient / 32°F (0°C) Box Temperature

Evaporator Inlet	Evaporator Outlet	Suction Line	Compressor Top	Compressor Bottom	Condenser Inlet	Condenser Outlet
10°F	14°F	49°F	94°F	91°F	103°F	84°F
-12°C	-10°C	9°C	34°C	33°C	39°C	29°C

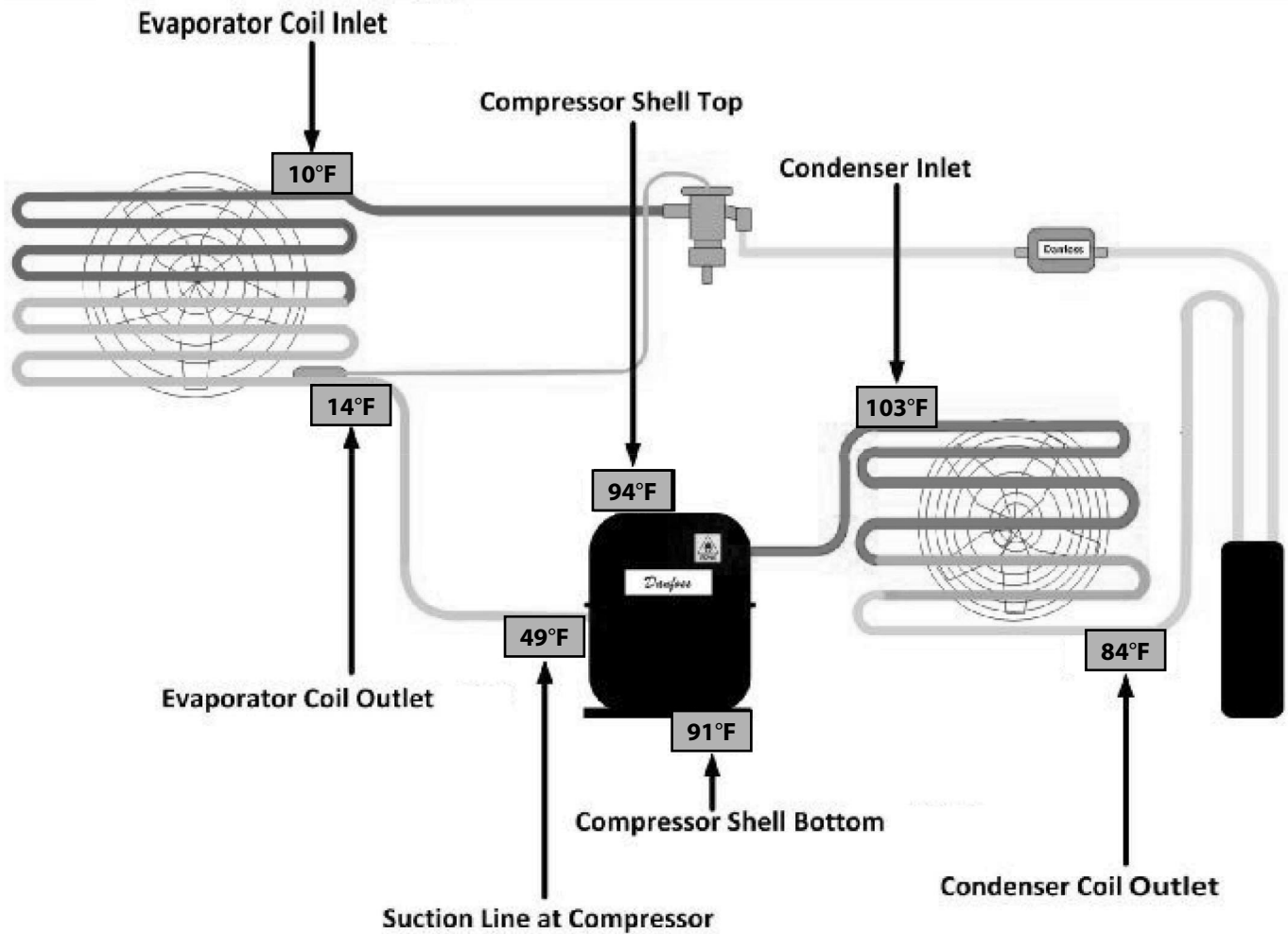

1 SECTION REACH-IN REFRIGERATOR

86°F (30°C) Ambient / 32°F (0°C) Box Temperature

Evaporator Inlet	Evaporator Outlet	Suction Line	Compressor Top	Compressor Bottom	Condenser Inlet	Condenser Outlet
11°F	14°F	57°F	105°F	103°F	116°F	91°F
-12°C	-10°C	14°C	41°C	39°C	47°C	33°C

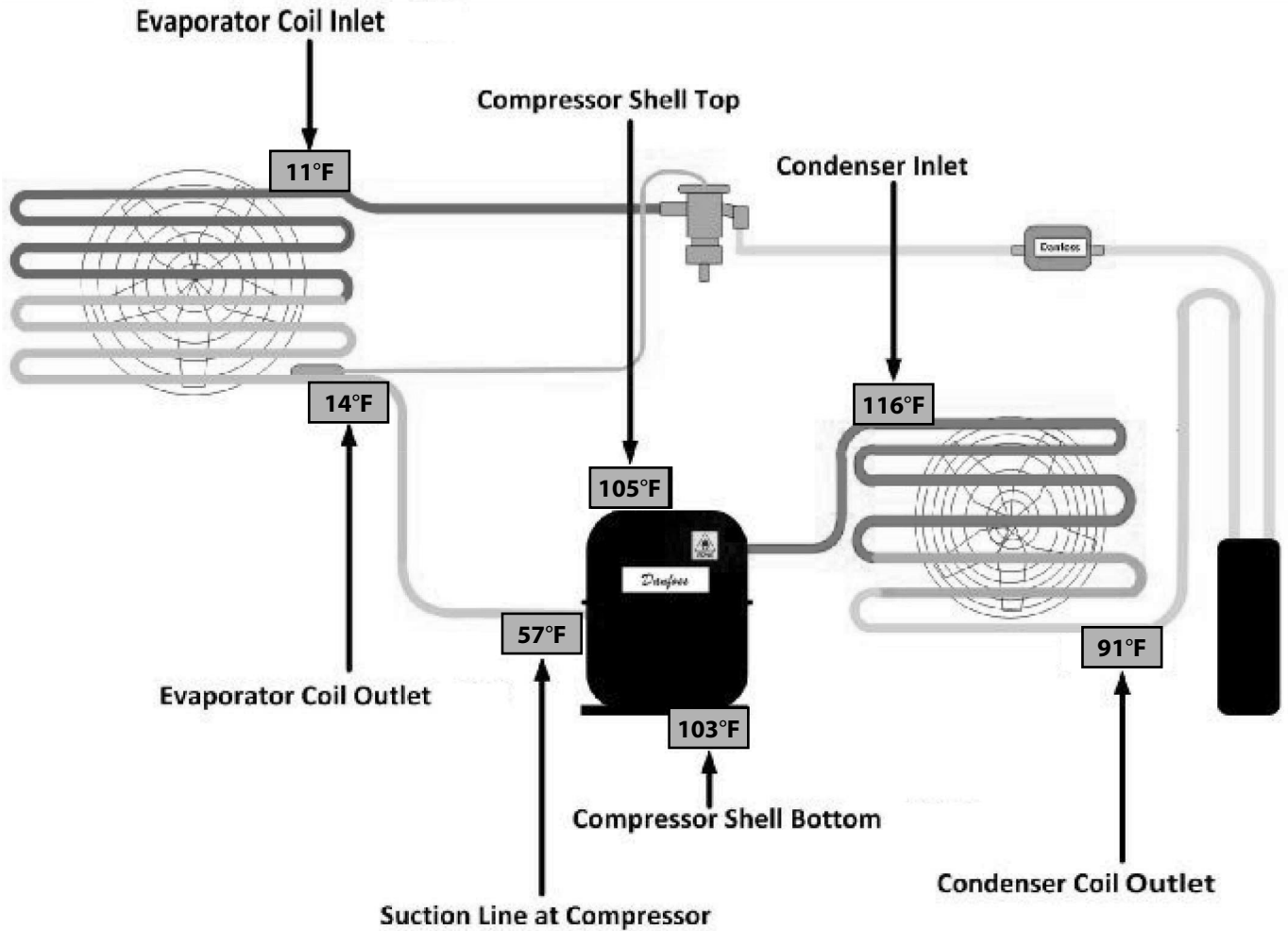

1 SECTION REACH-IN REFRIGERATOR

100°F (38°C) Ambient / 32°F (0°C) Box Temperature

Evaporator Inlet	Evaporator Outlet	Suction Line	Compressor Top	Compressor Bottom	Condenser Inlet	Condenser Outlet
10°F	14°F	63°F	123°F	120°F	135°F	103°F
-12°C	-10°C	17°C	51°C	49°C	57°C	39°C

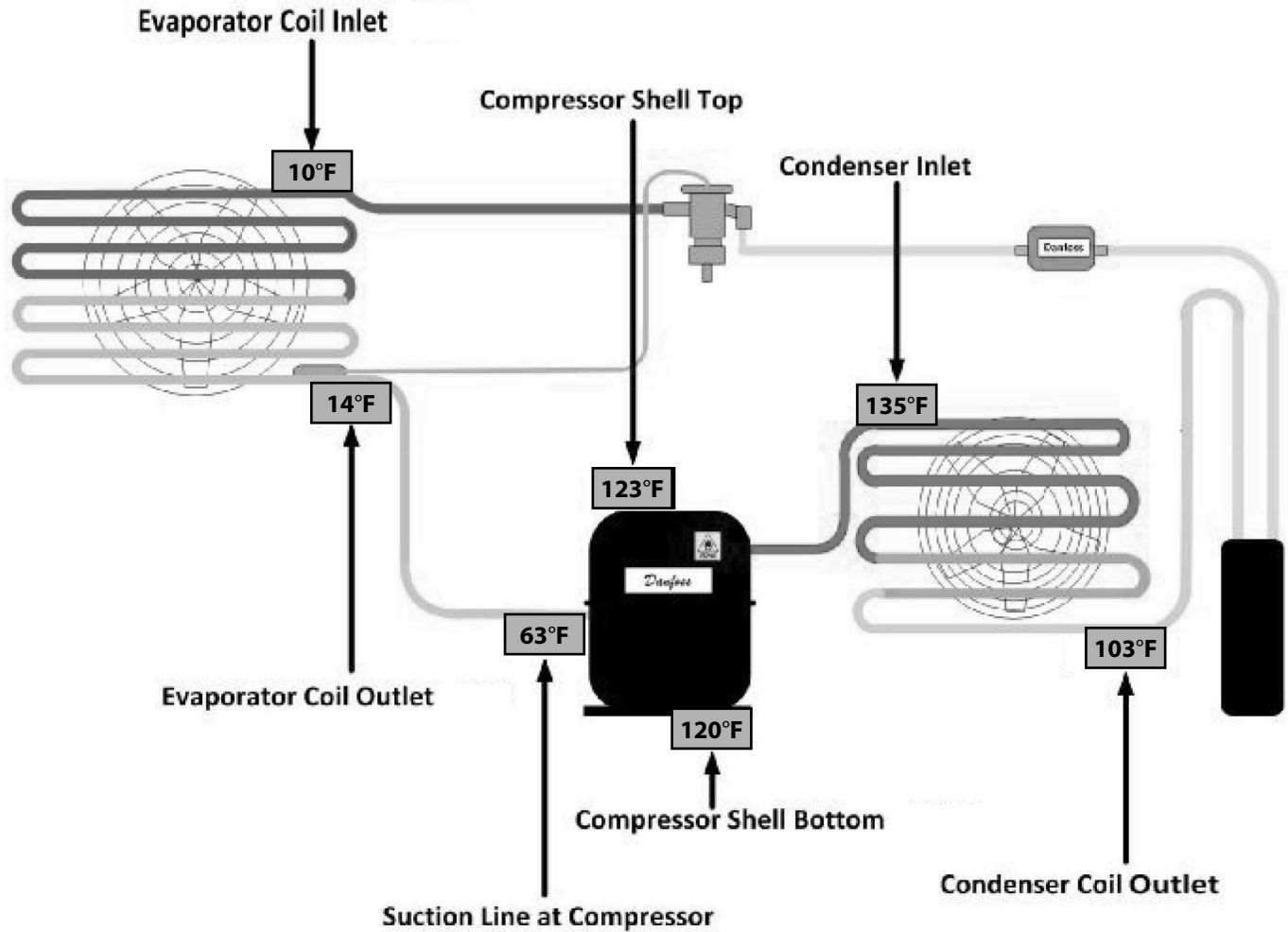

2 SECTION REACH-IN REFRIGERATOR

75°F (24°C) Ambient / 32°F (0°C) Box Temperature

Evaporator Inlet	Evaporator Outlet	Suction Line	Compressor Top	Compressor Bottom	Condenser Inlet	Condenser Outlet
11°F	18°F	46°F	100°F	93°F	110°F	87°F
-12°C	-8°C	8°C	38°C	34°C	43°C	31°C

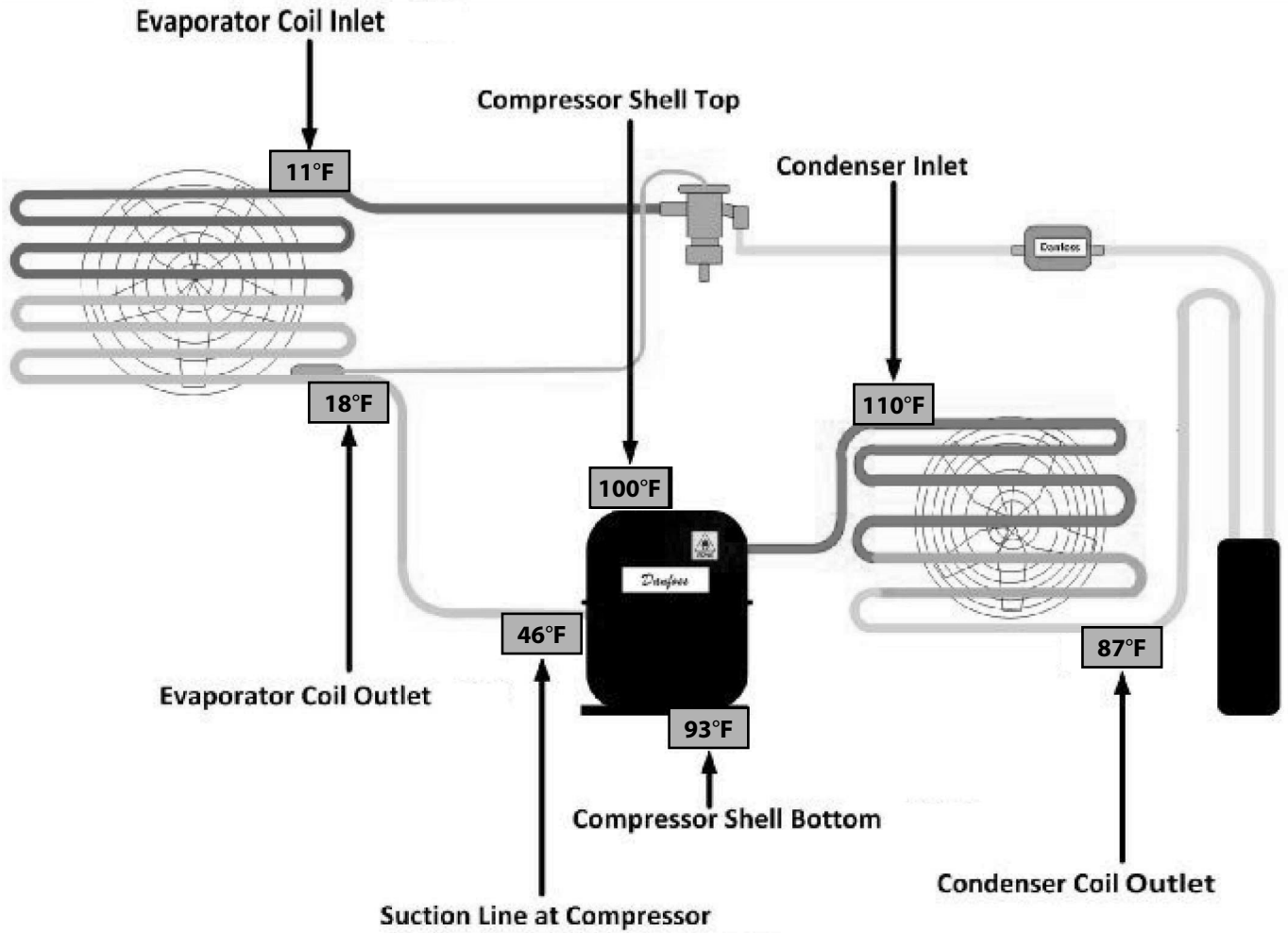

2 SECTION REACH-IN REFRIGERATOR

86°F (30°C) Ambient / 32°F (0°C) Box Temperature

Evaporator Inlet	Evaporator Outlet	Suction Line	Compressor Top	Compressor Bottom	Condenser Inlet	Condenser Outlet
13°F	20°F	50°F	112°F	103°F	116°F	96°F
-11°C	-7°C	10°C	44°C	39°C	47°C	36°C

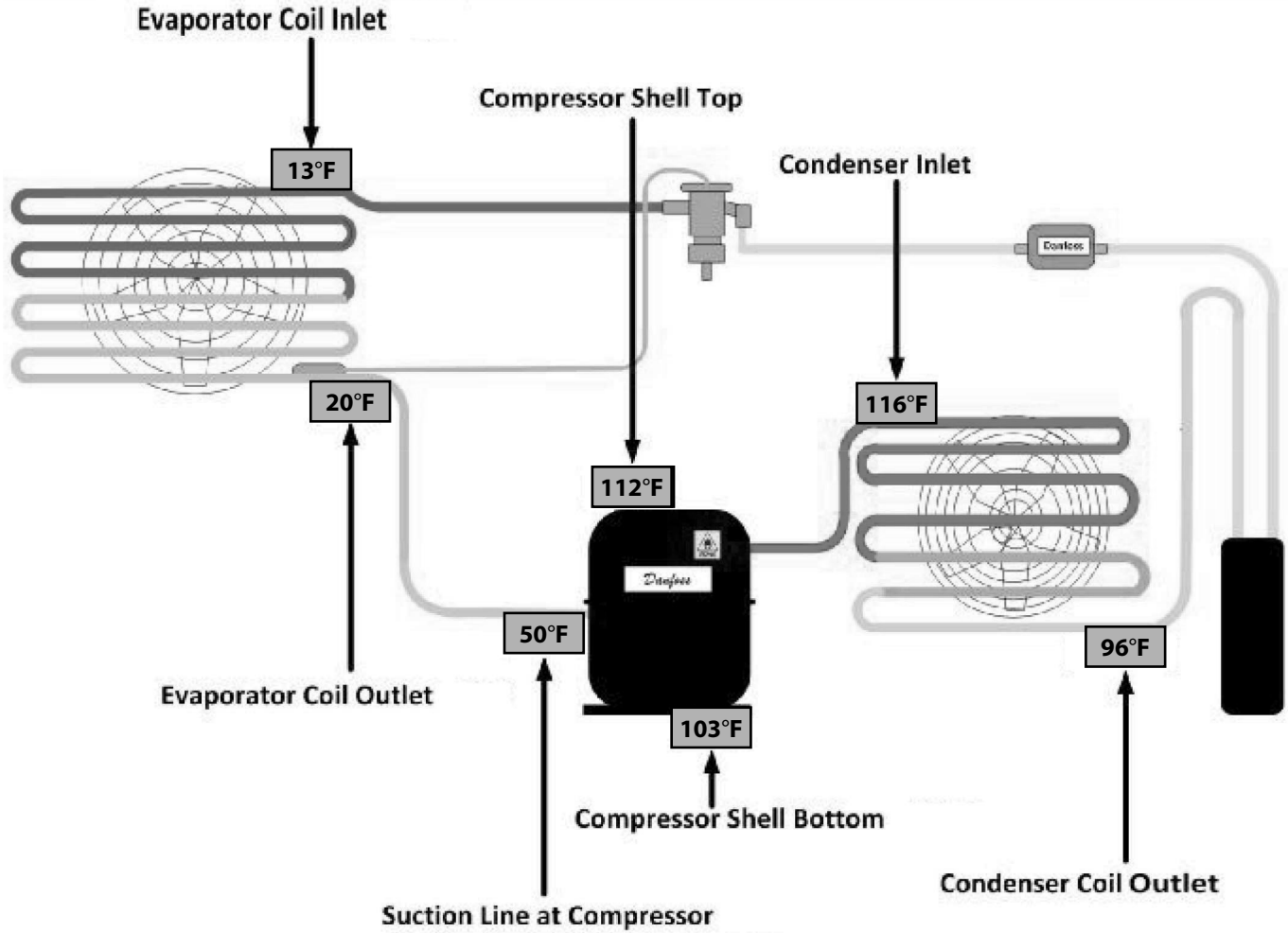

2 SECTION REACH-IN REFRIGERATOR

100°F (38°C) Ambient / 32°F (0°C) Box Temperature

Evaporator Inlet	Evaporator Outlet	Suction Line	Compressor Top	Compressor Bottom	Condenser Inlet	Condenser Outlet
11°F	18°F	52°F	131°F	120°F	142°F	107°F
-12°C	-8°C	11°C	55°C	49°C	61°C	42°C

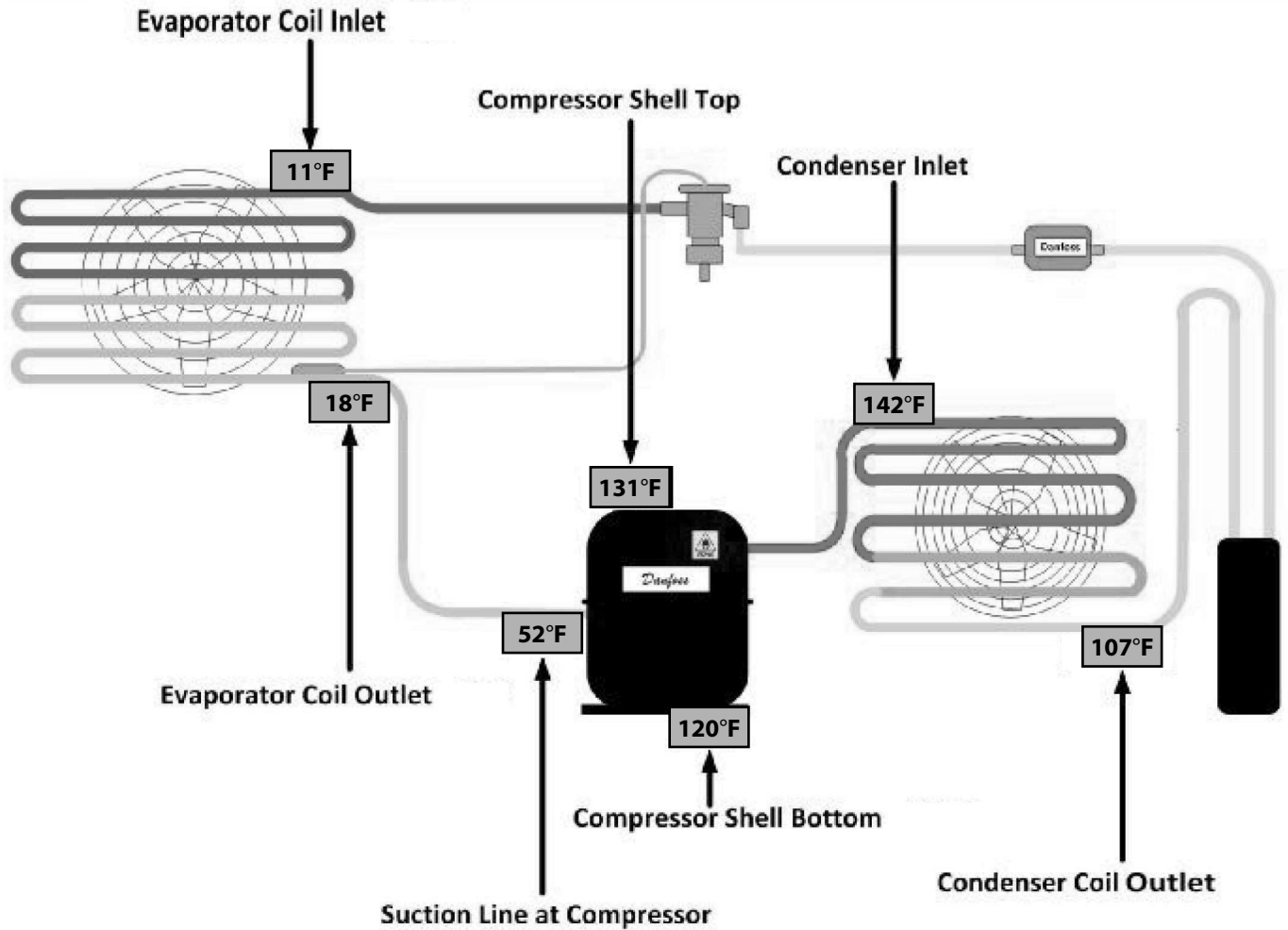

3 SECTION REACH-IN REFRIGERATOR

75°F (24°C) Ambient / 32°F (0°C) Box Temperature

Evaporator Inlet	Evaporator Outlet	Suction Line	Compressor Top	Compressor Bottom	Condenser Inlet	Condenser Outlet
17°F	25°F	52°F	113°F	102°F	114°F	91°F
-8°C	-4°C	11°C	45°C	39°C	46°C	33°C

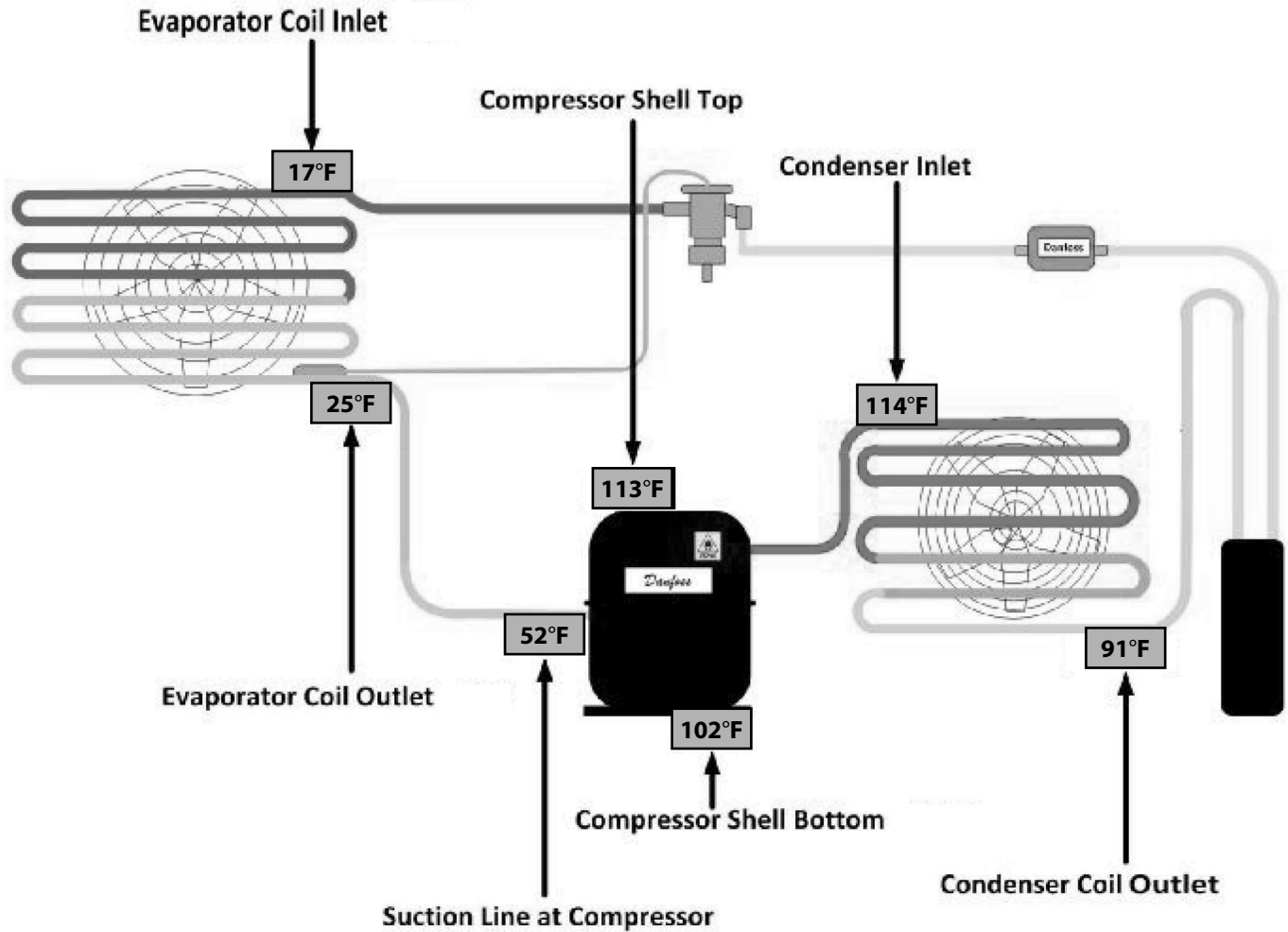

3 SECTION REACH-IN REFRIGERATOR

86°F (30°C) Ambient / 32°F (0°C) Box Temperature

Evaporator Inlet	Evaporator Outlet	Suction Line	Compressor Top	Compressor Bottom	Condenser Inlet	Condenser Outlet
18°F	25°F	54°F	122°F	111°F	125°F	98°F
-8°C	-4°C	12°C	50°C	44°C	52°C	37°C

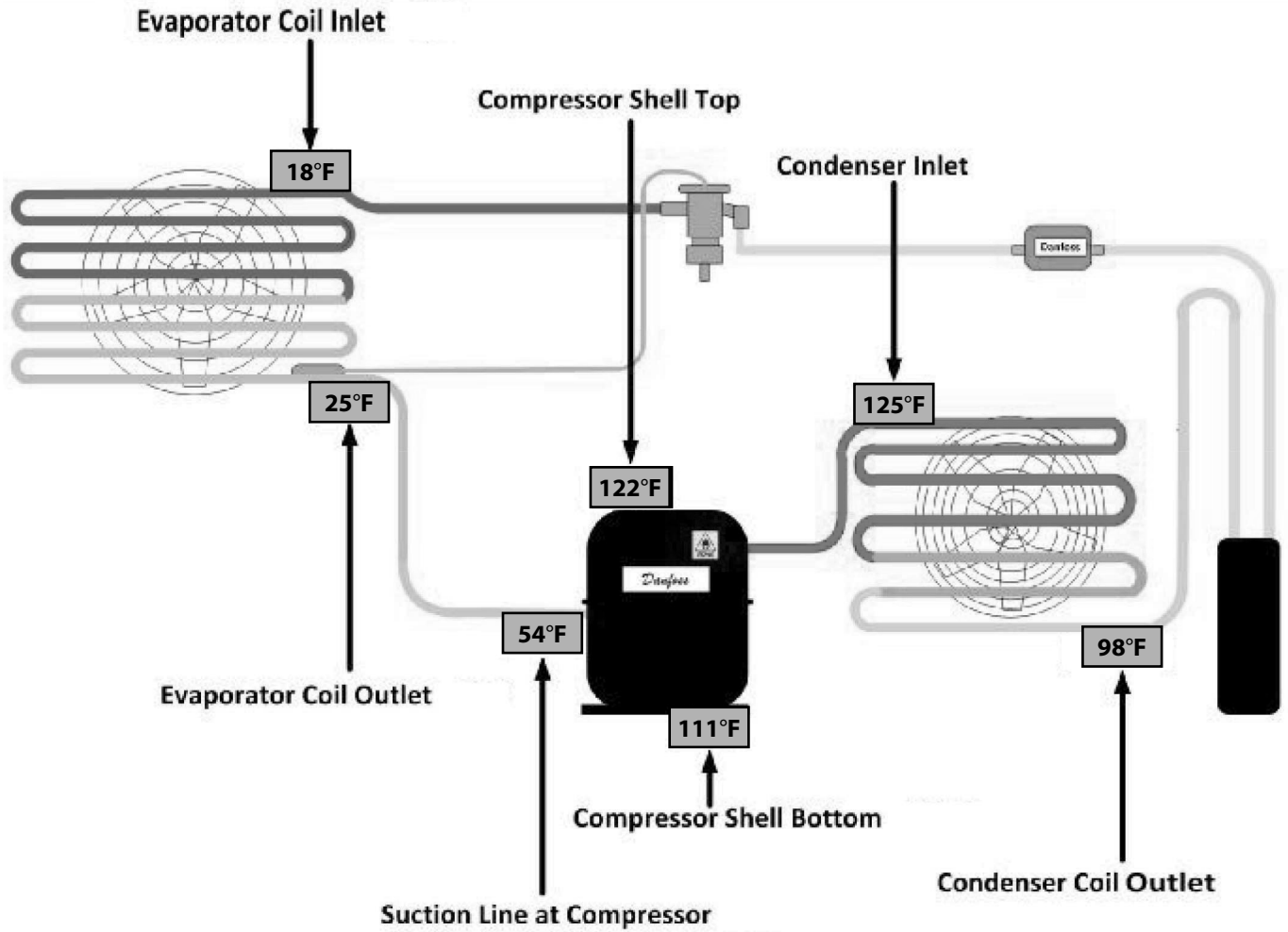

3 SECTION REACH-IN REFRIGERATOR

100°F (38°C) Ambient / 32°F (0°C) Box Temperature

Evaporator Inlet	Evaporator Outlet	Suction Line	Compressor Top	Compressor Bottom	Condenser Inlet	Condenser Outlet
22°F	26°F	61°F	140°F	128°F	145°F	114°F
-6°C	-3°C	16°C	60°C	53°C	63°C	46°C

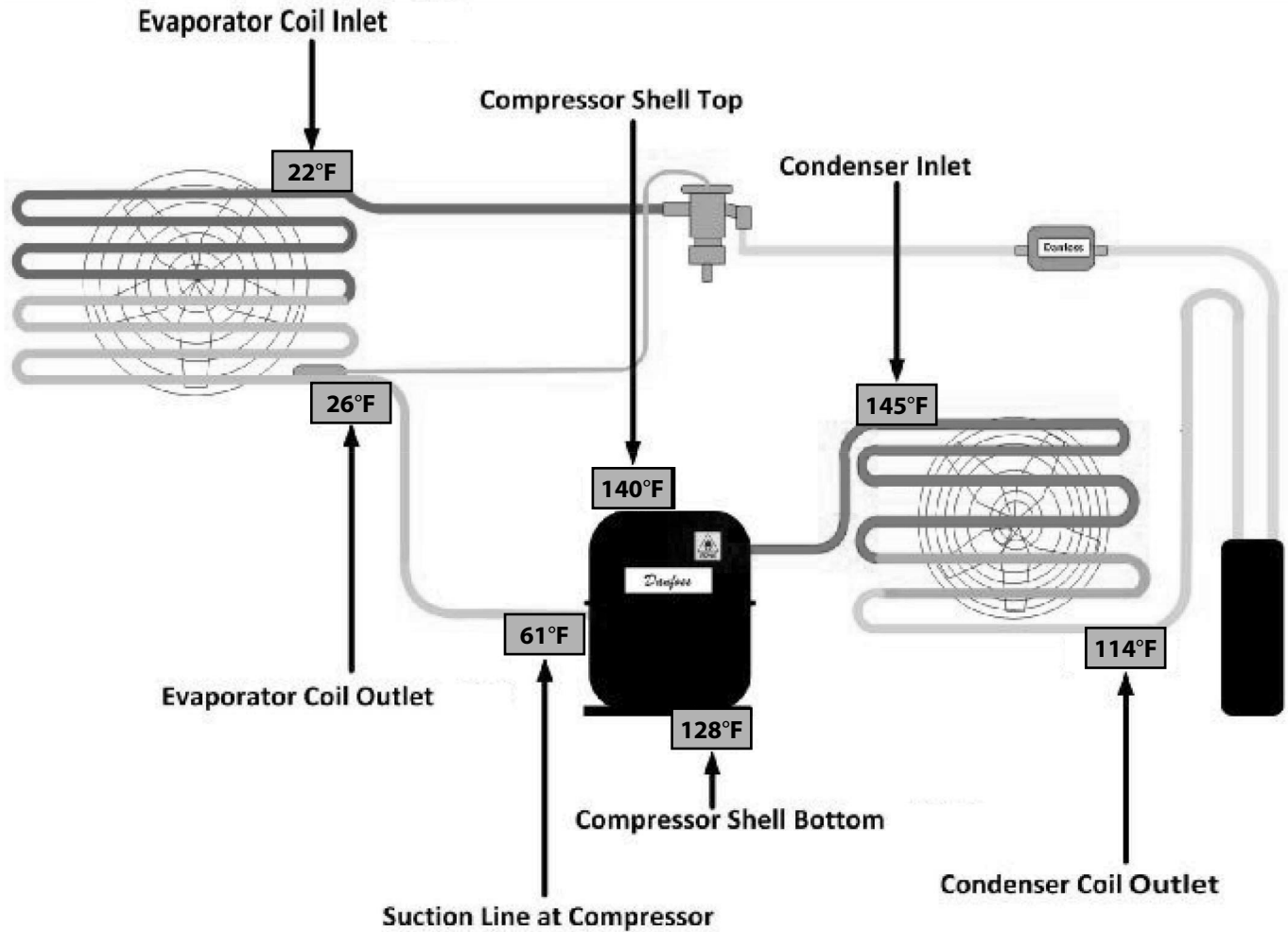

1 SECTION REACH-IN FREEZER

75°F (24°C) Ambient / 32°F (0°C) Box Temperature

Evaporator Inlet	Evaporator Outlet	Suction Line	Compressor Top	Compressor Bottom	Condenser Inlet	Condenser Outlet
-22°F	-20°F	8°F	114°F	103°F	120°F	88°F
-30°C	-29°C	-13°C	46°C	39°C	49°C	31°C

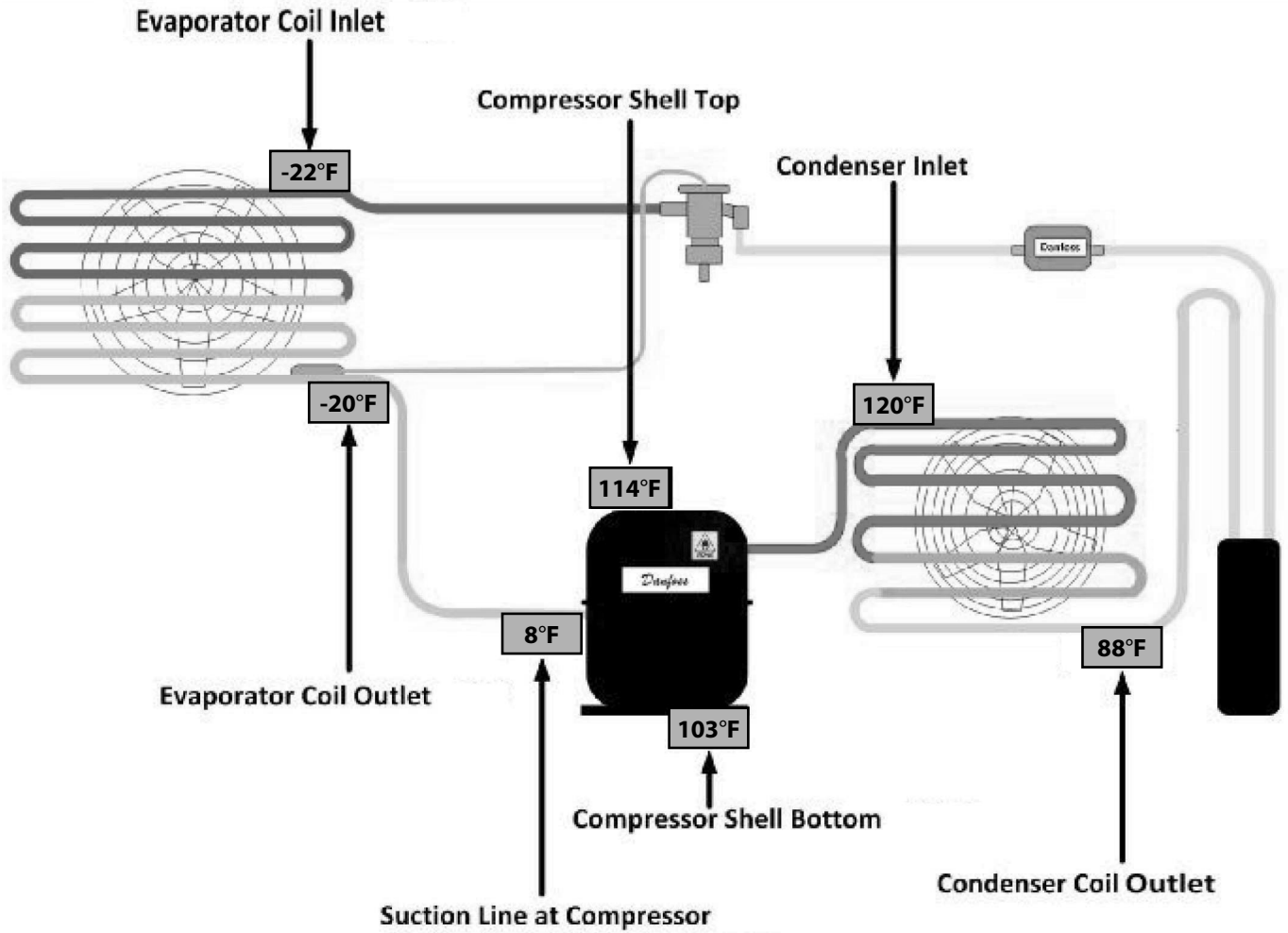

1 SECTION REACH-IN FREEZER

86°F (30°C) Ambient / 32°F (0°C) Box Temperature

Evaporator Inlet	Evaporator Outlet	Suction Line	Compressor Top	Compressor Bottom	Condenser Inlet	Condenser Outlet
-22°F	-20°F	13°F	129°F	117°F	140°F	97°F
-30°C	-29°C	-11°C	54°C	47°C	60°C	36°C

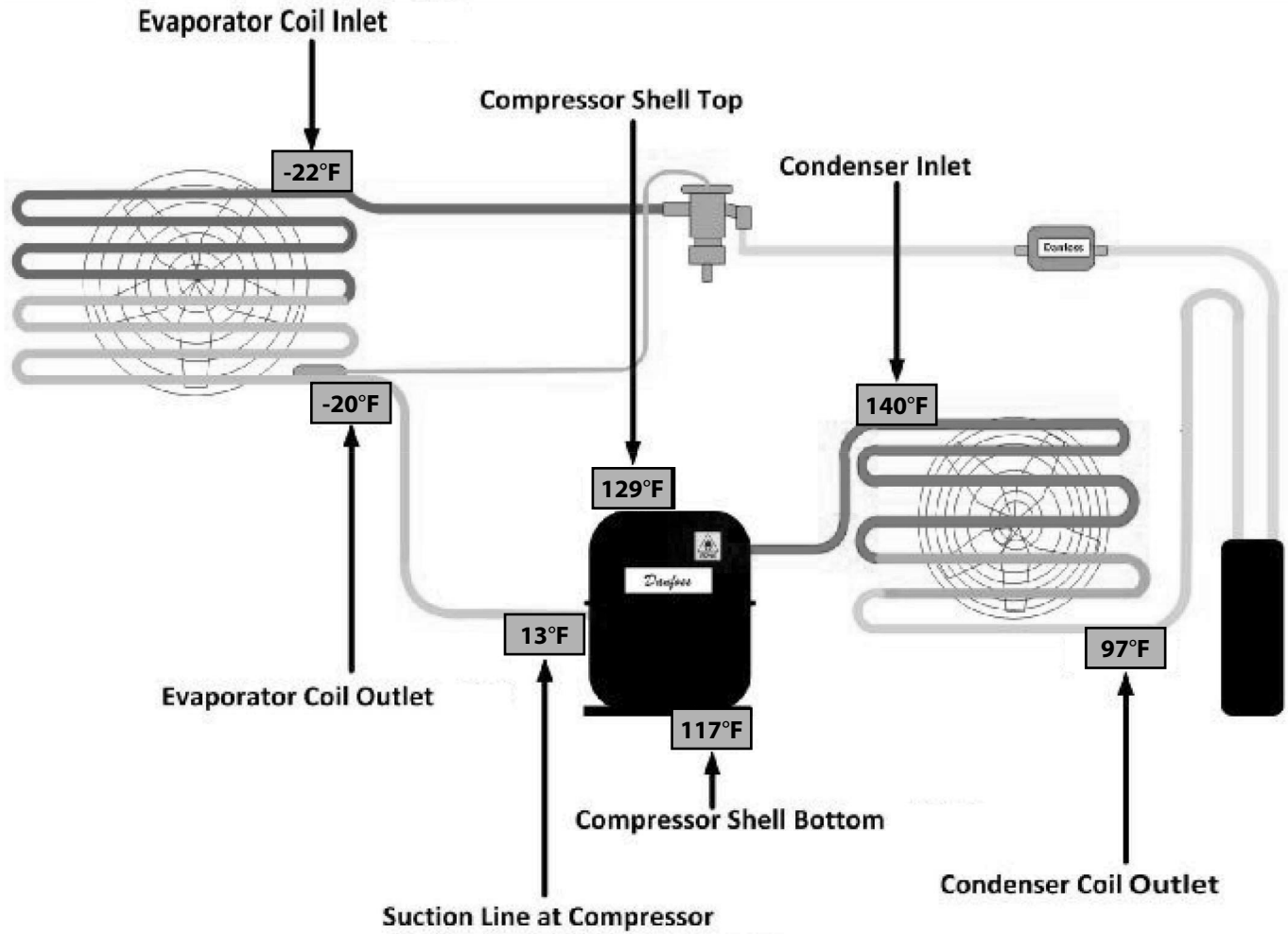

1 SECTION REACH-IN FREEZER

100°F (38°C) Ambient / 32°F (0°C) Box Temperature

Evaporator Inlet	Evaporator Outlet	Suction Line	Compressor Top	Compressor Bottom	Condenser Inlet	Condenser Outlet
-19°F	-16°F	20°F	145°F	132°F	157°F	111°F
-28°C	-27°C	-7°C	63°C	56°C	69°C	44°C

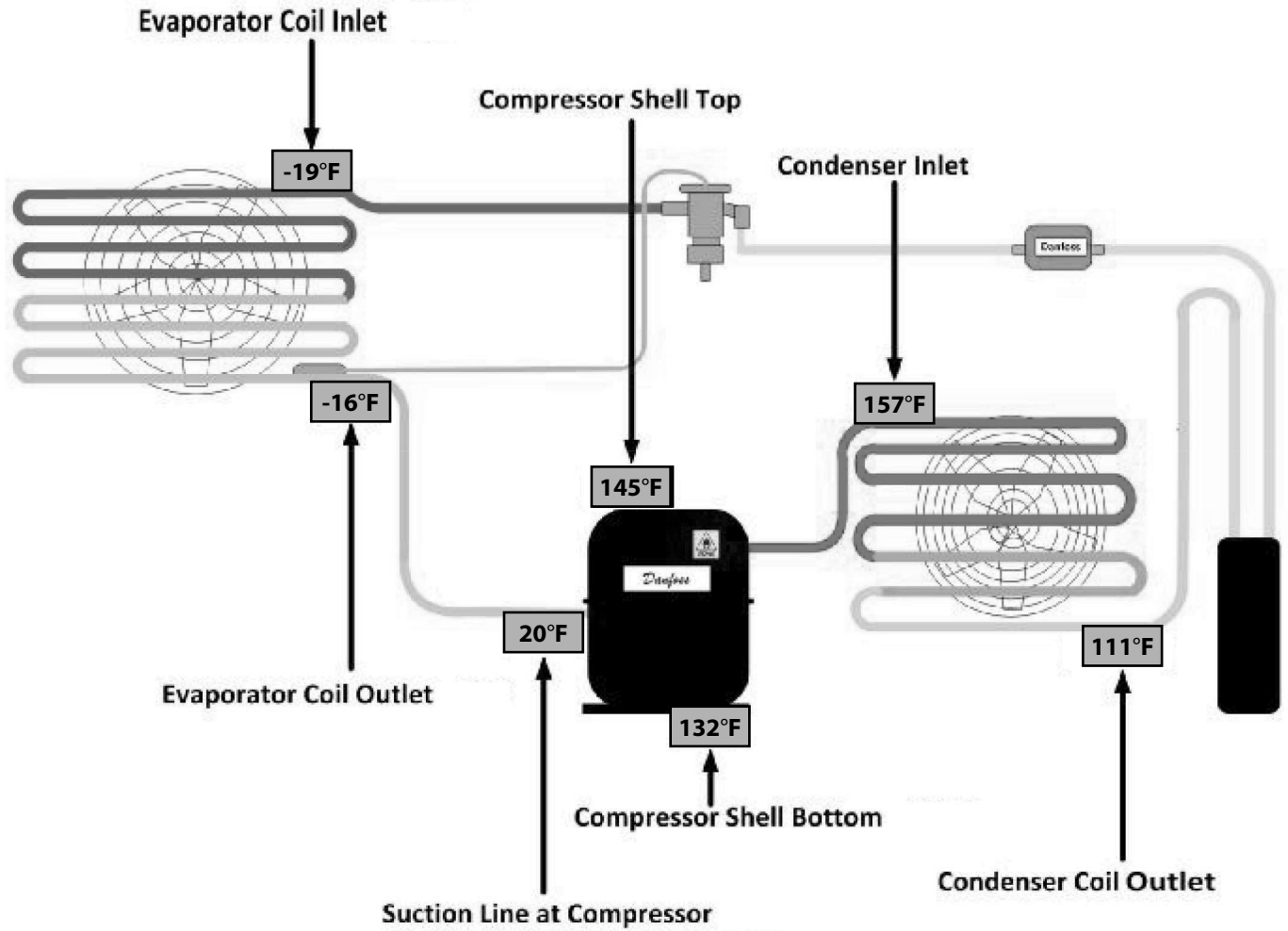

2 SECTION REACH-IN FREEZER

75°F (24°C) Ambient / 32°F (0°C) Box Temperature

Evaporator Inlet	Evaporator Outlet	Suction Line	Compressor Top	Compressor Bottom	Condenser Inlet	Condenser Outlet
-18°F	-13°F	22°F	117°F	108°F	132°F	84°F
-28°C	-25°C	-6°C	47°C	42°C	56°C	29°C

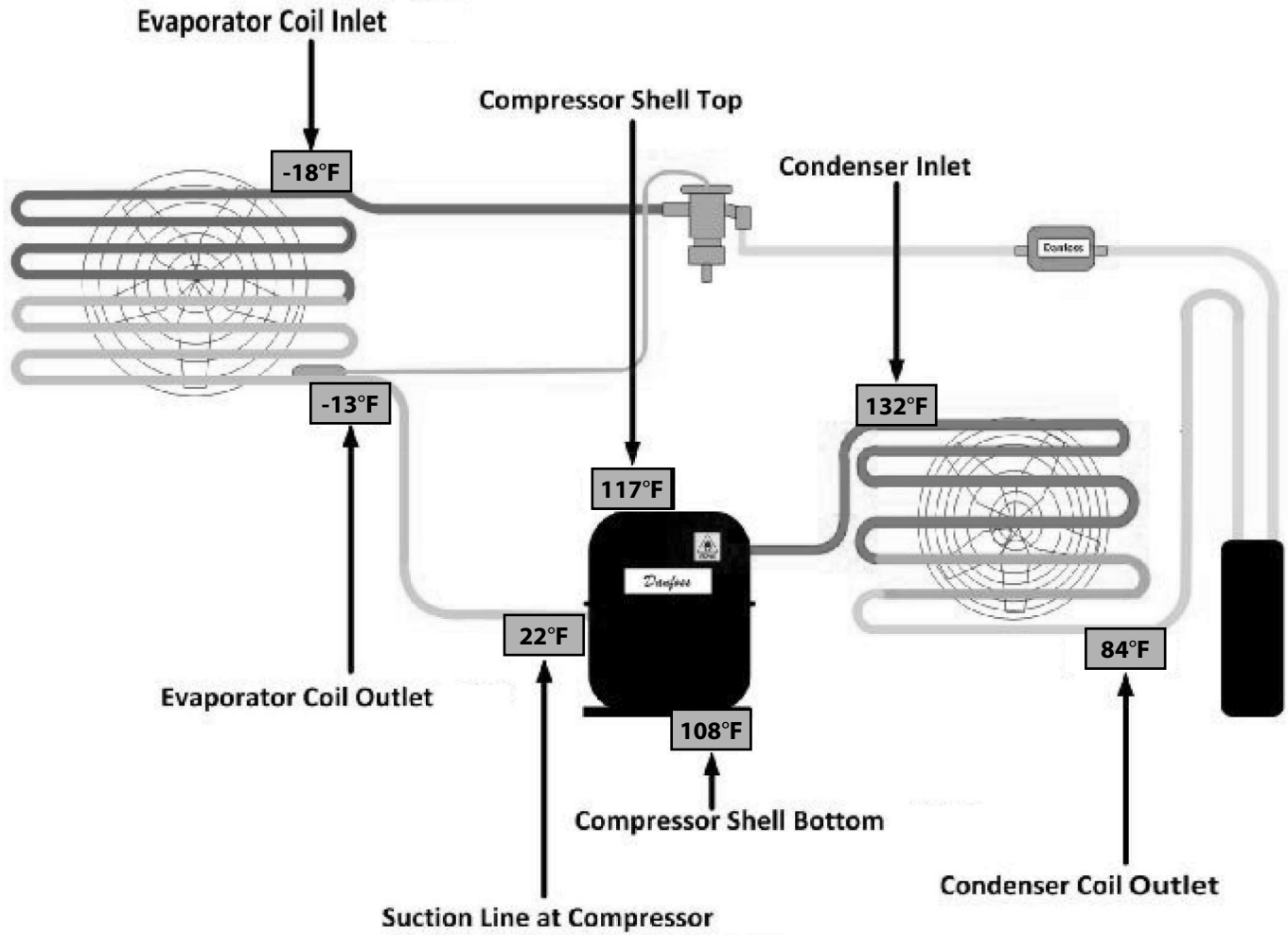

2 SECTION REACH-IN FREEZER

86°F (30°C) Ambient / 32°F (0°C) Box Temperature

Evaporator Inlet	Evaporator Outlet	Suction Line	Compressor Top	Compressor Bottom	Condenser Inlet	Condenser Outlet
-18°F	-13°F	29°F	134°F	121°F	147°F	95°F
-28°C	-25°C	-2°C	57°C	49°C	64°C	35°C

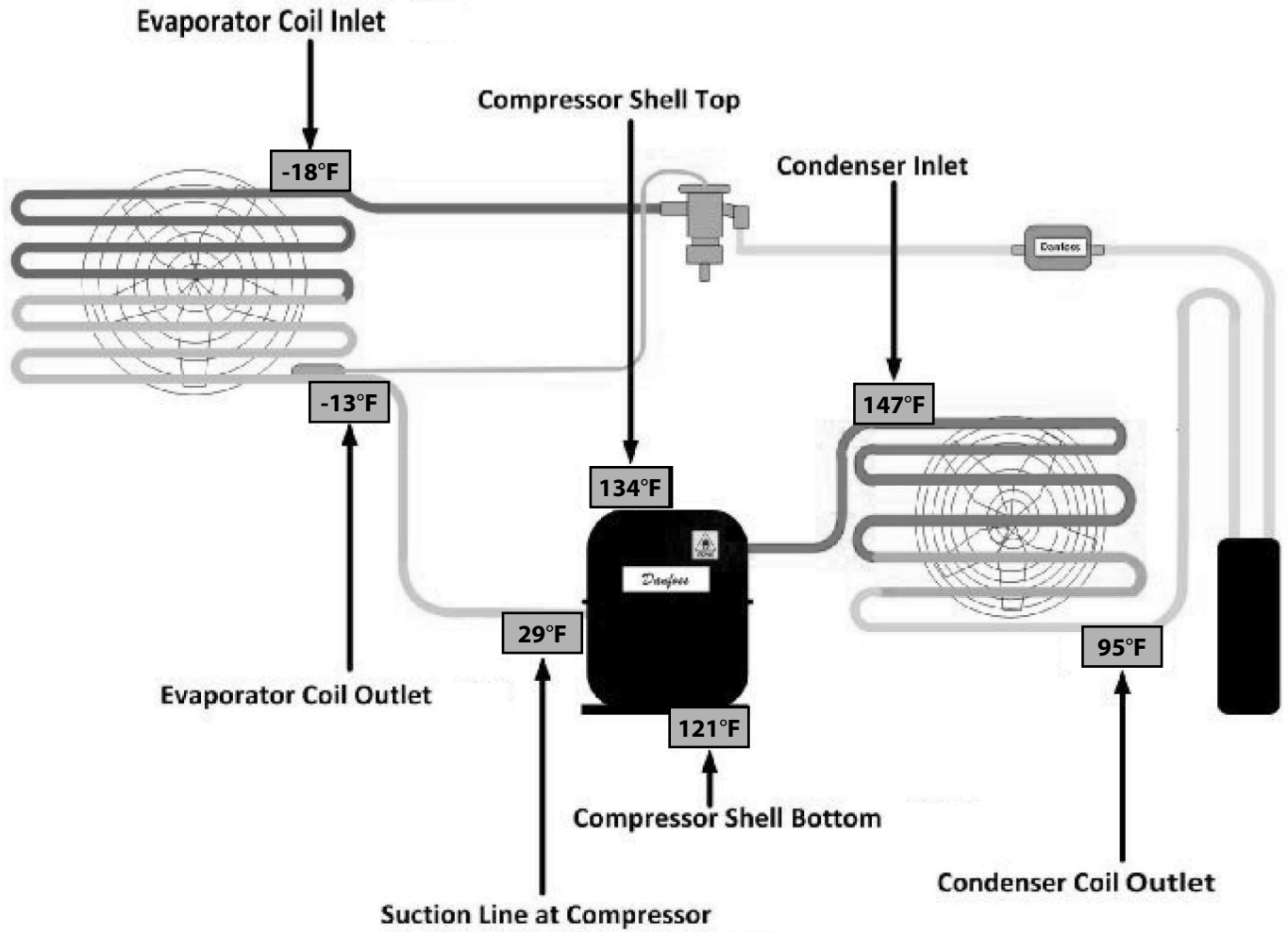

2 SECTION REACH-IN FREEZER

100°F (38°C) Ambient / 32°F (0°C) Box Temperature

Evaporator Inlet	Evaporator Outlet	Suction Line	Compressor Top	Compressor Bottom	Condenser Inlet	Condenser Outlet
-17°F	-12°F	35°F	152°F	139°F	165°F	109°F
-27°C	-24°C	2°C	67°C	59°C	74°C	43°C

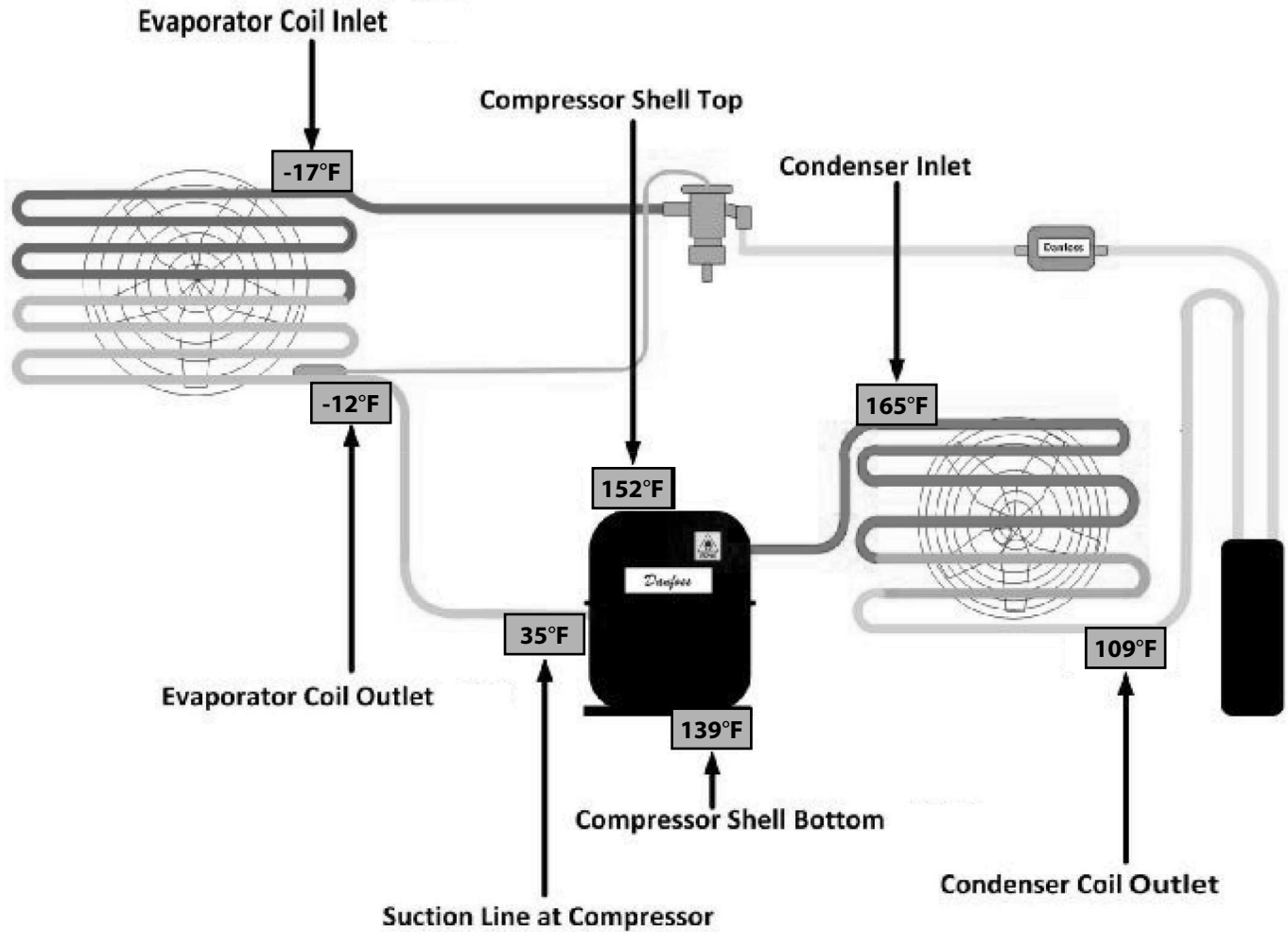

3 SECTION REACH-IN FREEZER

75°F (24°C) Ambient / 32°F (0°C) Box Temperature

Evaporator Inlet	Evaporator Outlet	Suction Line	Compressor Top	Compressor Bottom	Condenser Inlet	Condenser Outlet
-23°F	-17°F	43°F	134°F	120°F	142°F	91°F
-31°C	-27°C	6°C	57°C	49°C	61°C	33°C

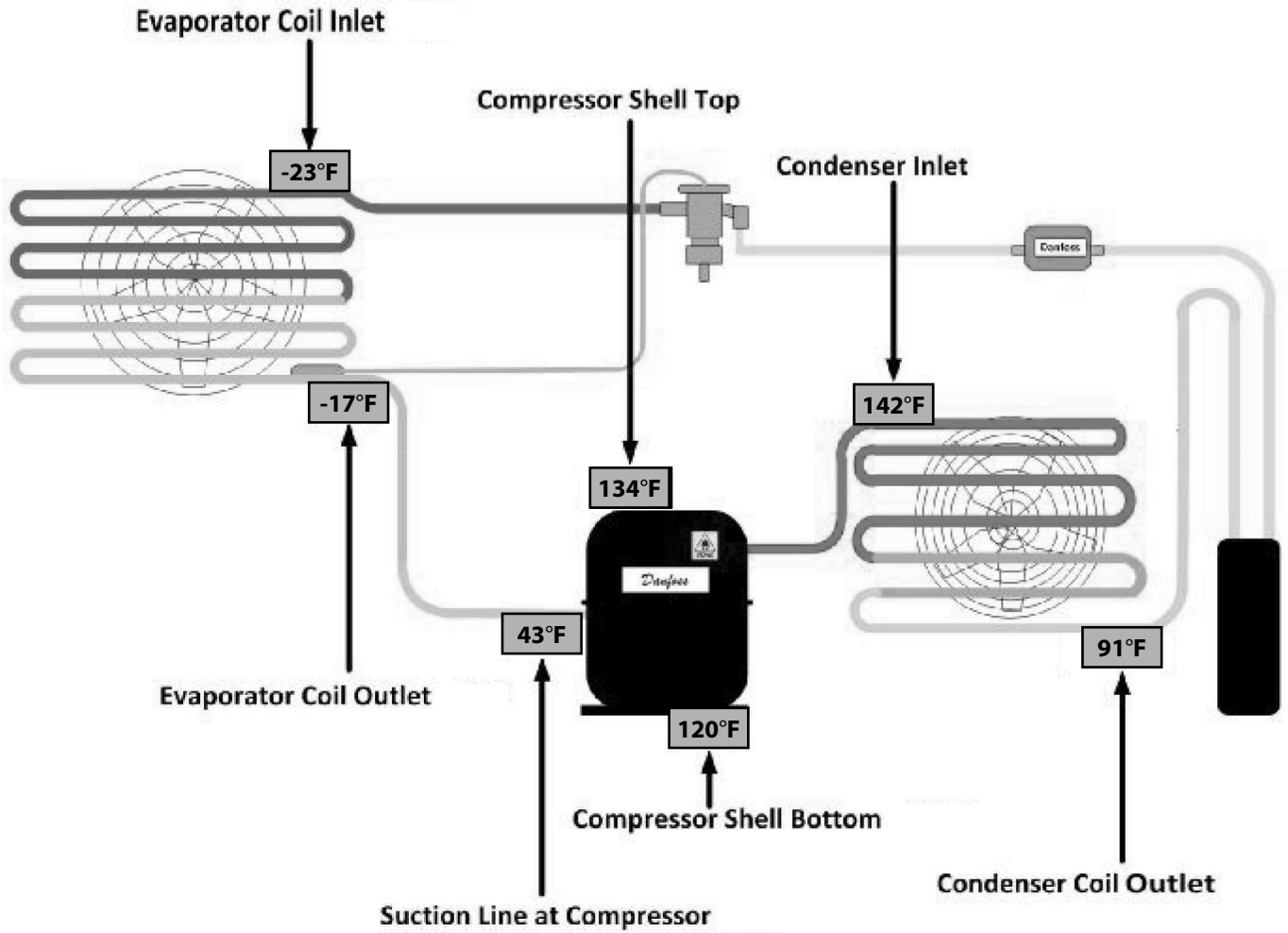

3 SECTION REACH-IN FREEZER

86°F (30°C) Ambient / 32°F (0°C) Box Temperature

Evaporator Inlet	Evaporator Outlet	Suction Line	Compressor Top	Compressor Bottom	Condenser Inlet	Condenser Outlet
-22°F	-16°F	48°F	146°F	130°F	152°F	100°F
-30°C	-27°C	9°C	63°C	54°C	67°C	38°C

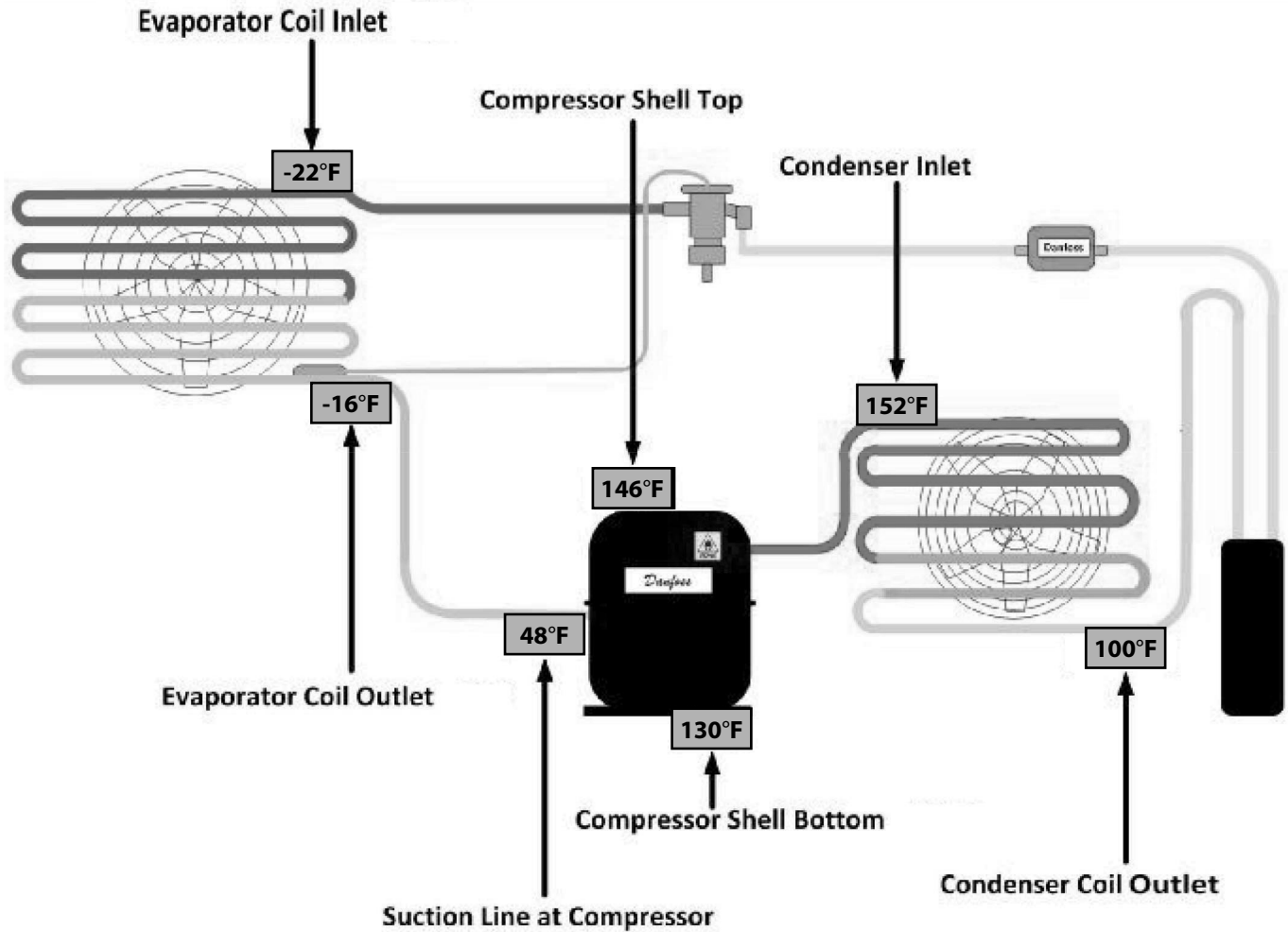

3 SECTION REACH-IN FREEZER

100°F (38°C) Ambient / 32°F (0°C) Box Temperature

Evaporator Inlet	Evaporator Outlet	Suction Line	Compressor Top	Compressor Bottom	Condenser Inlet	Condenser Outlet
-21°F	-16°F	59°F	161°F	145°F	166°F	112°F
-29°C	-27°C	15°C	72°C	63°C	74°C	44°C

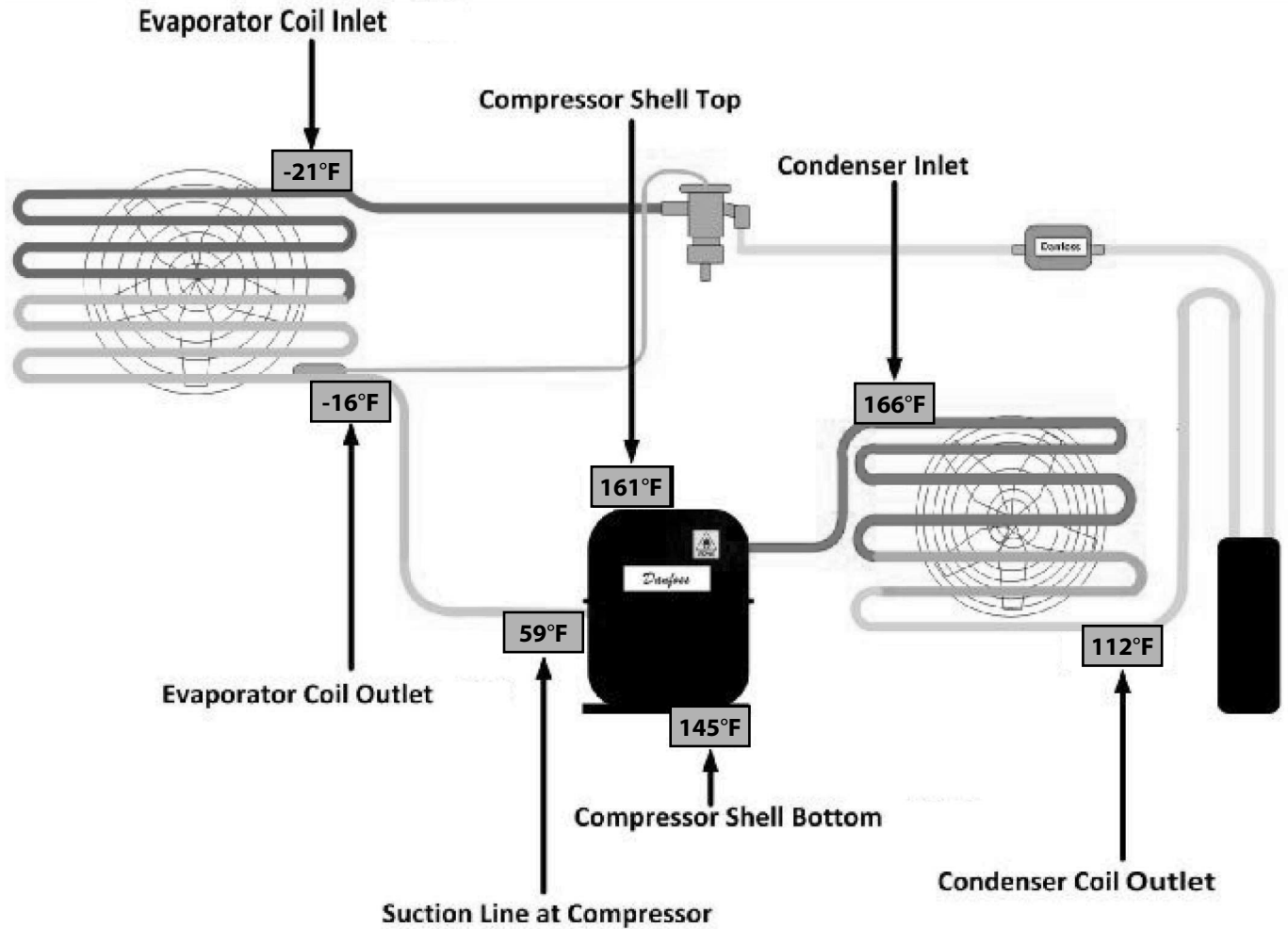

1 SECTION PASS-THRU REFRIGERATOR

75°F (24°C) Ambient / 32°F (0°C) Box Temperature

Evaporator Inlet	Evaporator Outlet	Suction Line	Compressor Top	Compressor Bottom	Condenser Inlet	Condenser Outlet
4°F	15°F	44°F	107°F	84°F	112°F	85°F
-16°C	-9°C	7°C	42°C	29°C	44°C	29°C

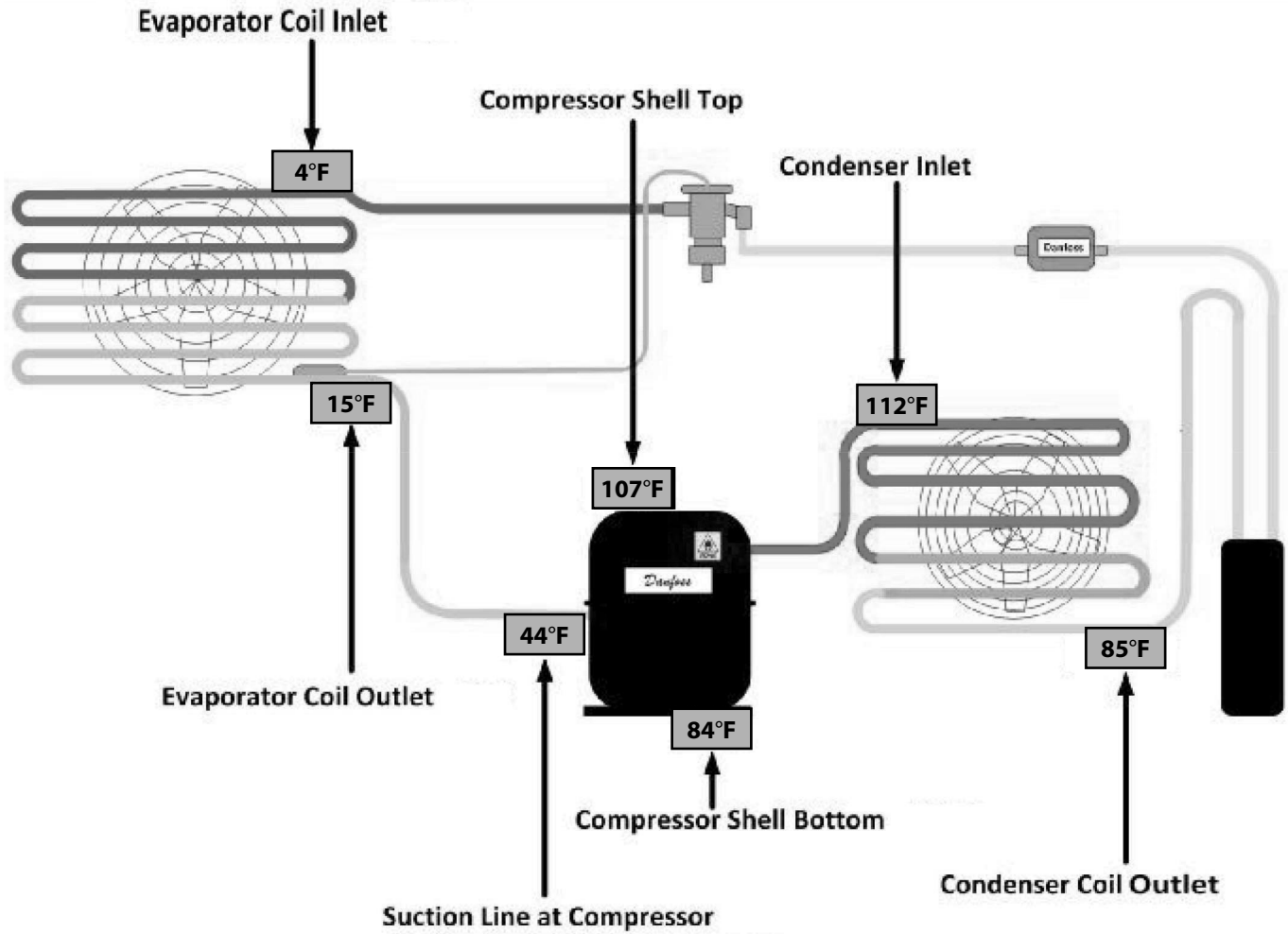

1 SECTION PASS-THRU REFRIGERATOR

86°F (30°C) Ambient / 32°F (0°C) Box Temperature

Evaporator Inlet	Evaporator Outlet	Suction Line	Compressor Top	Compressor Bottom	Condenser Inlet	Condenser Outlet
6°F	18°F	48°F	123°F	95°F	123°F	96°F
-14°C	-8°C	9°C	51°C	35°C	51°C	36°C

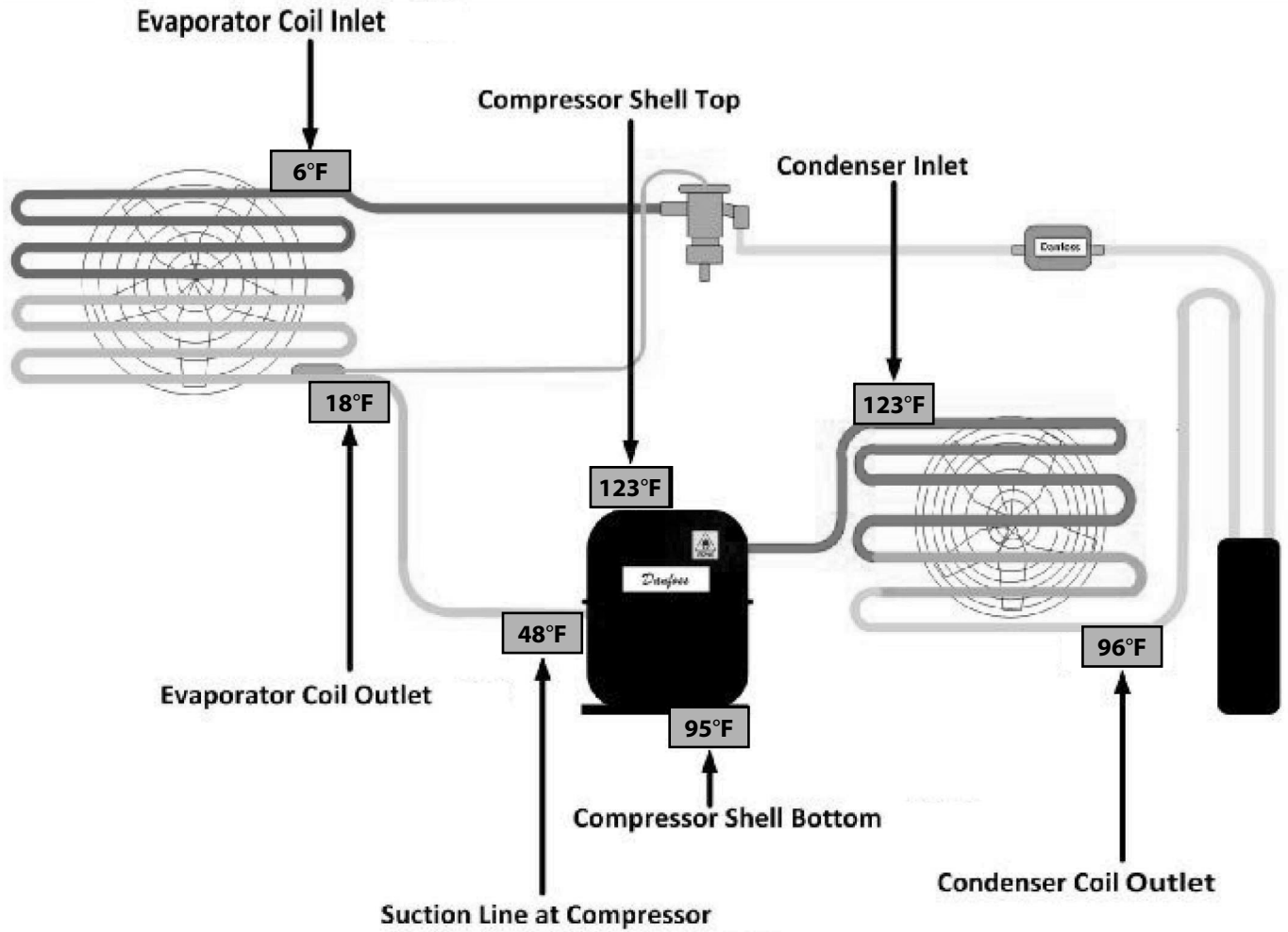

1 SECTION PASS-THRU REFRIGERATOR

100°F (38°C) Ambient / 32°F (0°C) Box Temperature

Evaporator Inlet	Evaporator Outlet	Suction Line	Compressor Top	Compressor Bottom	Condenser Inlet	Condenser Outlet
9°F	18°F	52°F	142°F	109°F	145°F	110°F
-13°C	-8°C	11°C	61°C	43°C	63°C	43°C

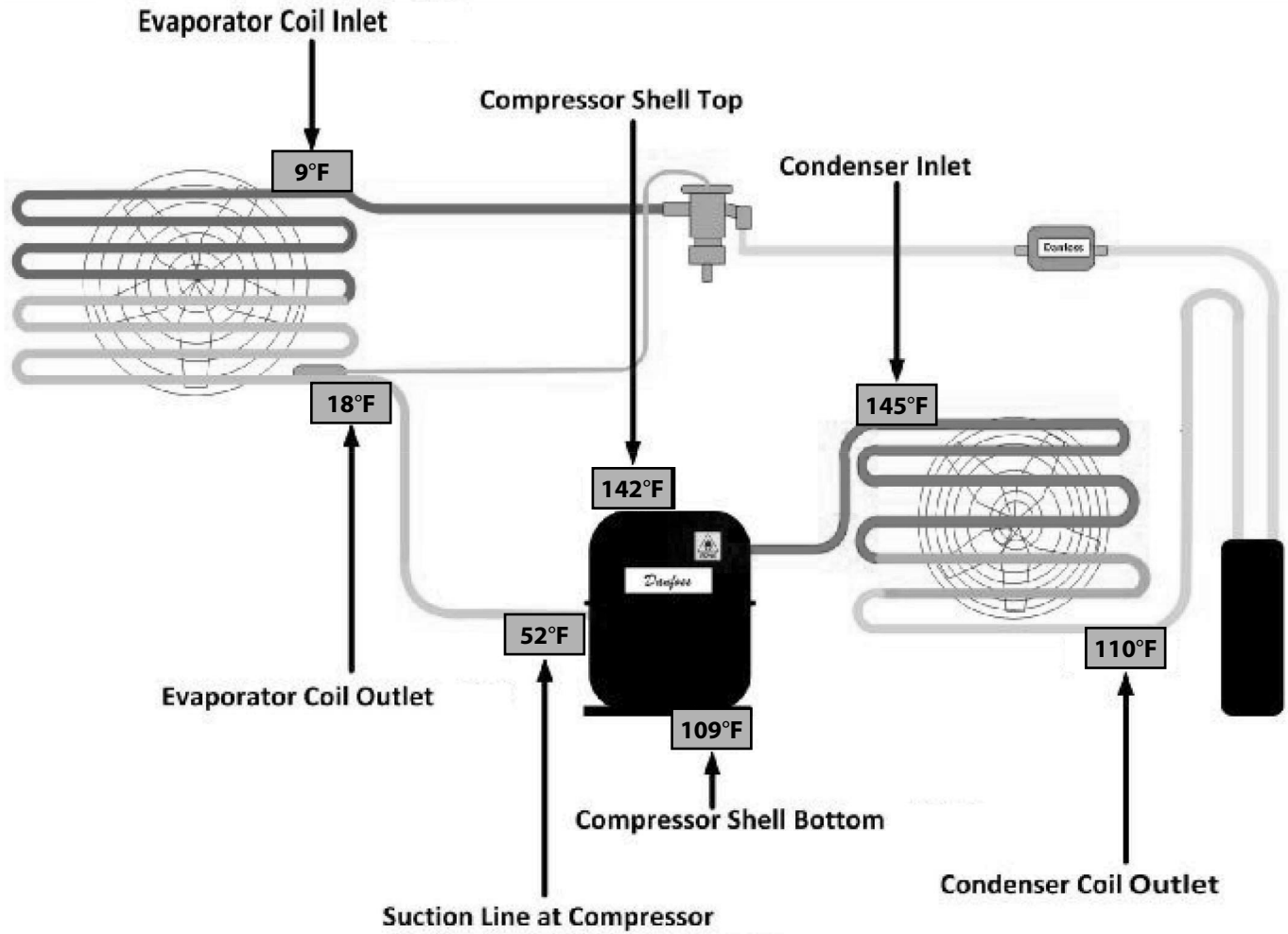

2 SECTION PASS-THRU REFRIGERATOR

75°F (24°C) Ambient / 32°F (0°C) Box Temperature

Evaporator Inlet	Evaporator Outlet	Suction Line	Compressor Top	Compressor Bottom	Condenser Inlet	Condenser Outlet
7°F	11°F	59°F	110°F	94°F	88°F	80°F
-14°C	-12°C	15°C	43°C	34°C	31°C	27°C

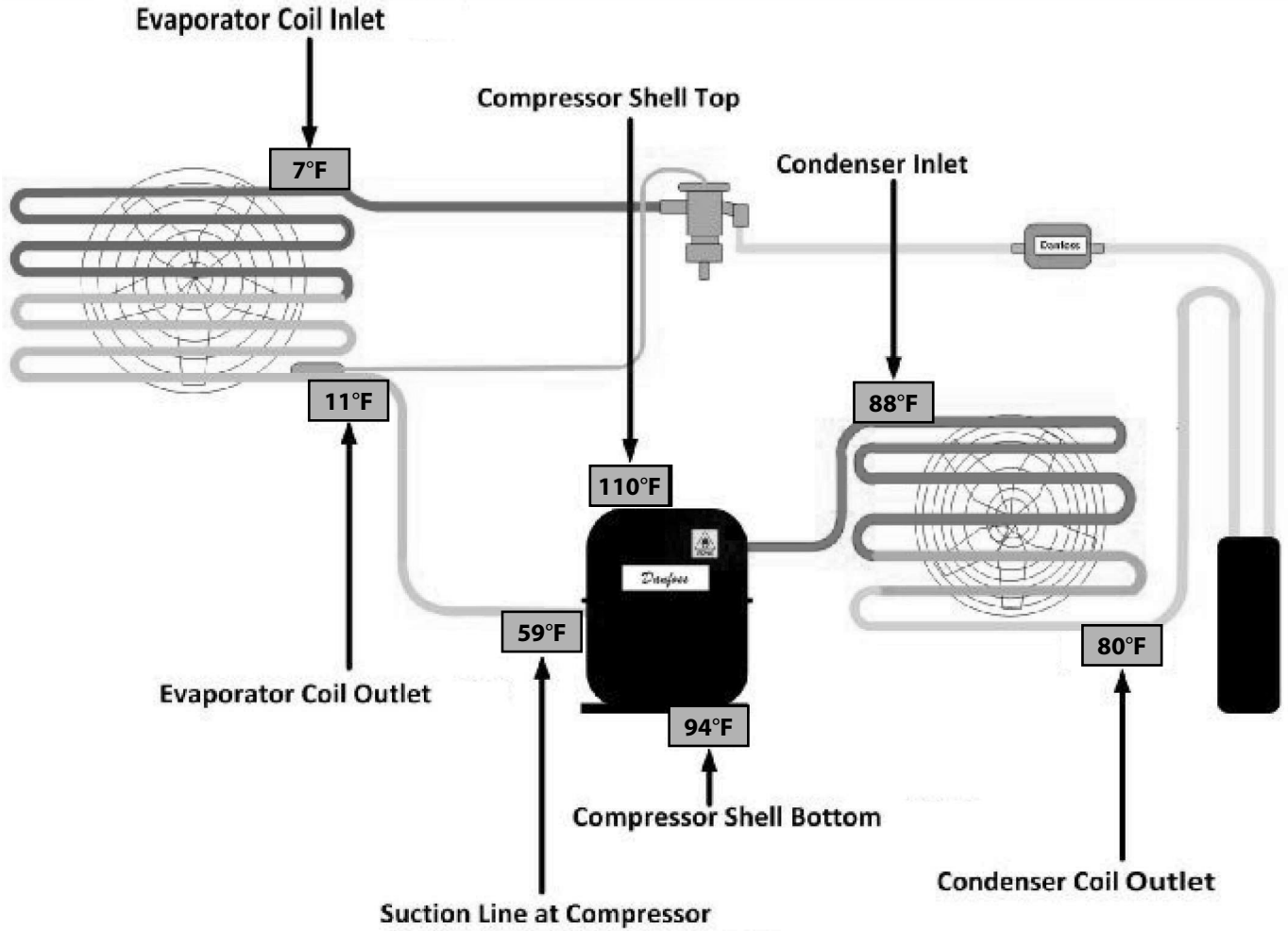

2 SECTION PASS-THRU REFRIGERATOR

86°F (30°C) Ambient / 32°F (0°C) Box Temperature

Evaporator Inlet	Evaporator Outlet	Suction Line	Compressor Top	Compressor Bottom	Condenser Inlet	Condenser Outlet
6°F	11°F	66°F	127°F	108°F	98°F	93°F
-14°C	-12°C	19°C	53°C	42°C	37°C	34°C

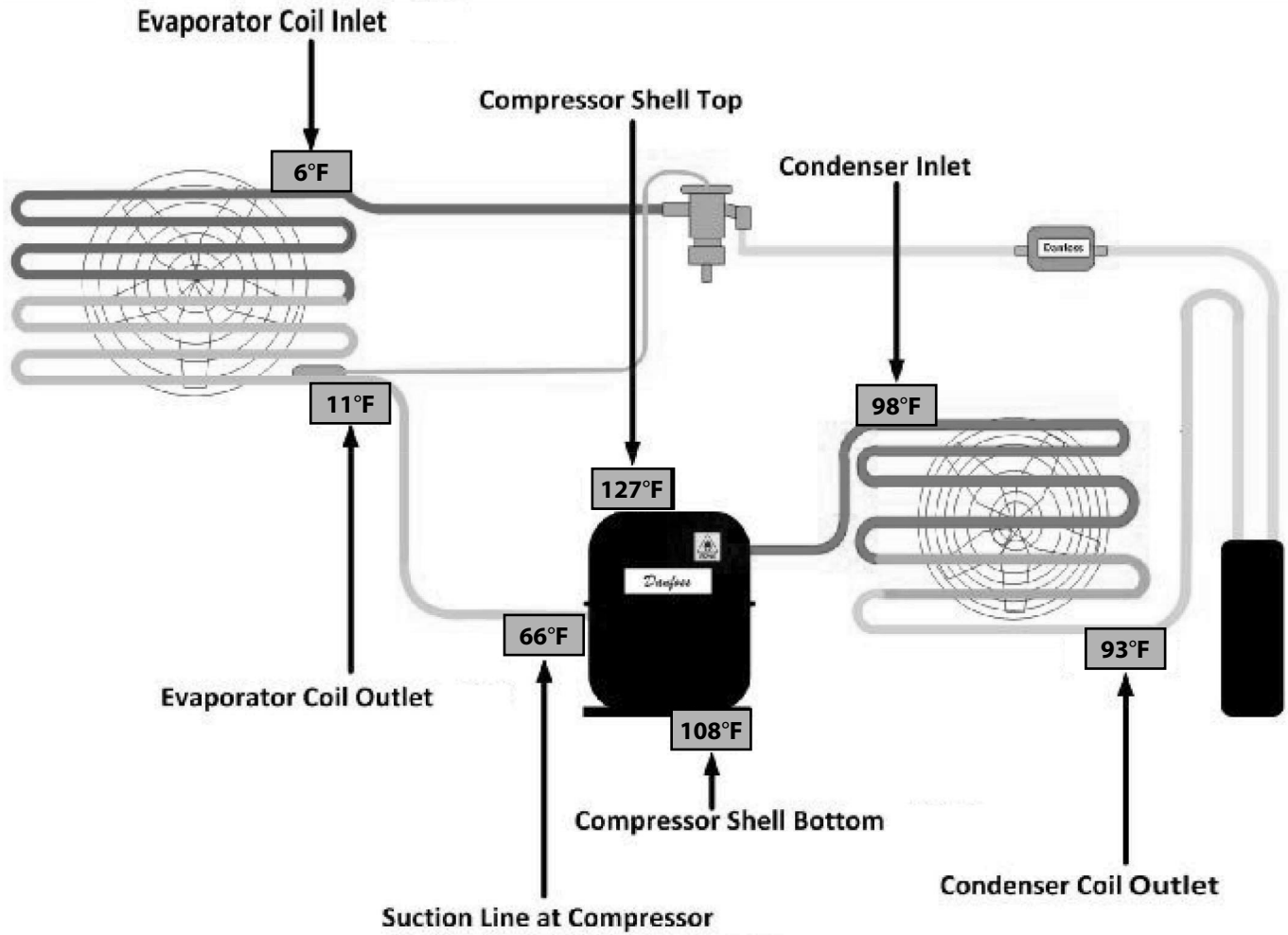

2 SECTION PASS-THRU REFRIGERATOR

100°F (38°C) Ambient / 32°F (0°C) Box Temperature

Evaporator Inlet	Evaporator Outlet	Suction Line	Compressor Top	Compressor Bottom	Condenser Inlet	Condenser Outlet
7°F	12°F	75°F	147°F	126°F	113°F	106°F
-14°C	-11°C	24°C	64°C	52°C	45°C	41°C

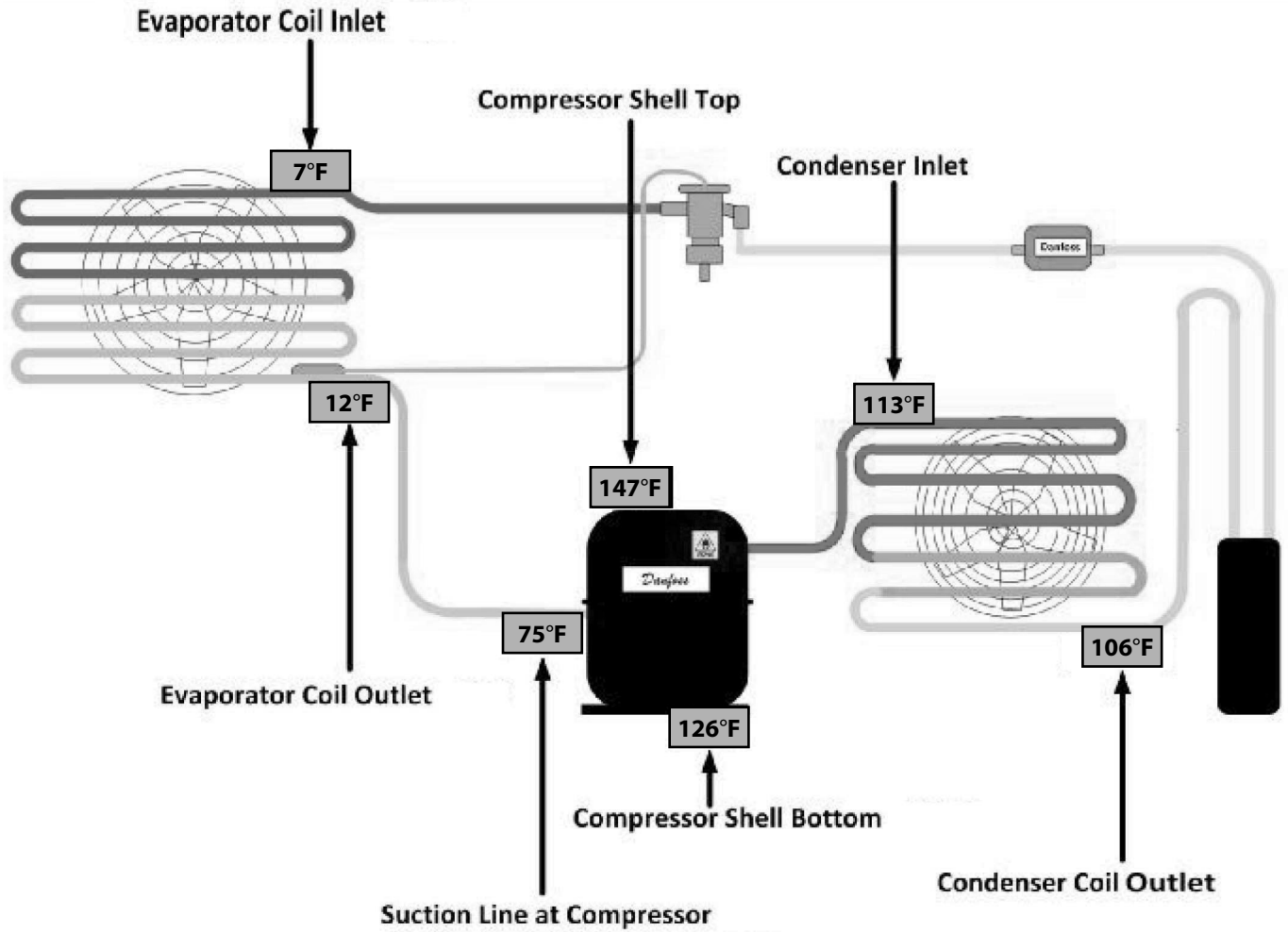

1 SECTION PASS-THRU FREEZER

75°F (24°C) Ambient / 32°F (0°C) Box Temperature

Evaporator Inlet	Evaporator Outlet	Suction Line	Compressor Top	Compressor Bottom	Condenser Inlet	Condenser Outlet
-26°F	-21°F	30°F	125°F	86°F	115°F	88°F
-32°C	-29°C	-1°C	52°C	30°C	46°C	31°C

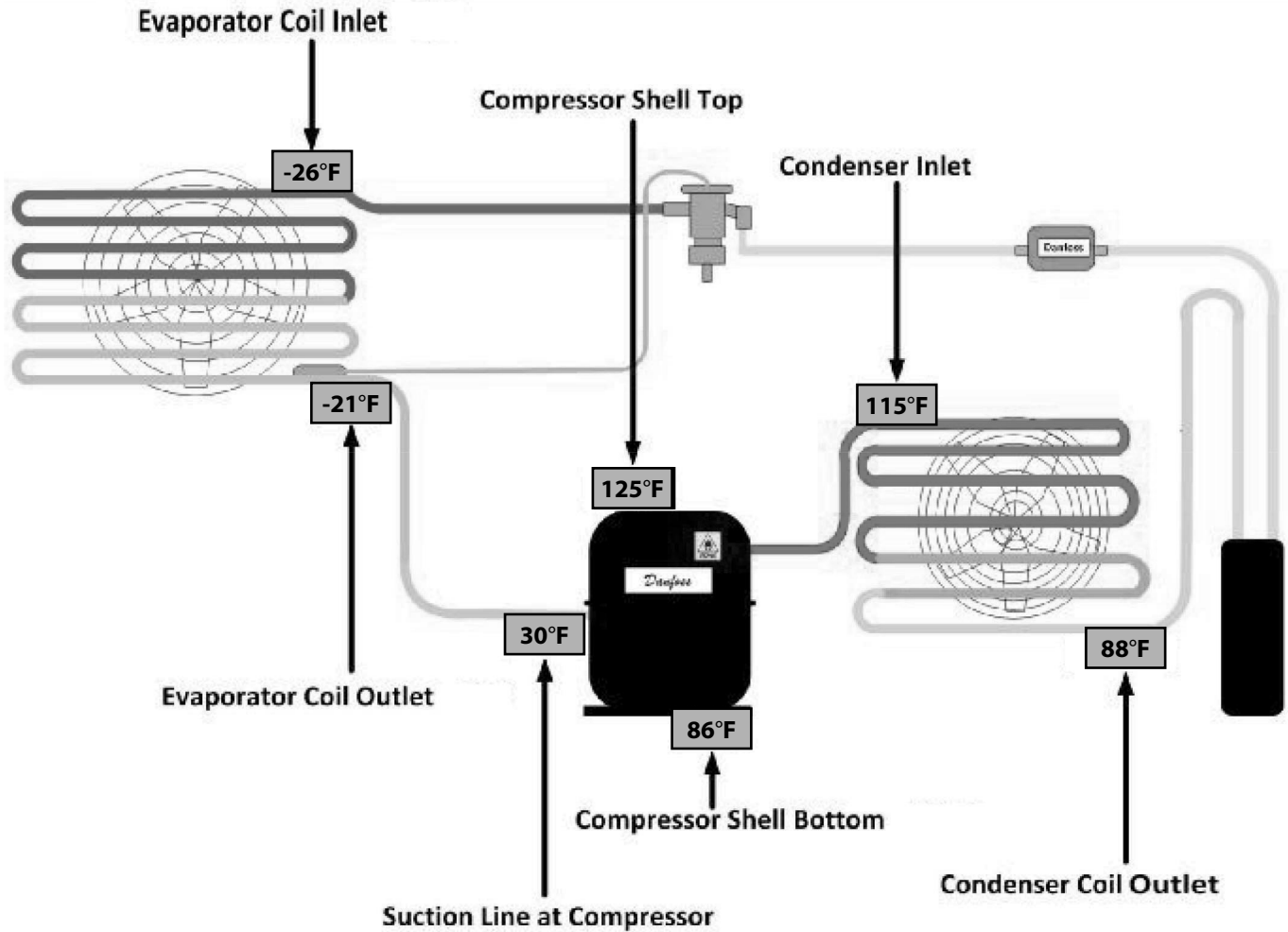

1 SECTION PASS-THRU FREEZER

86°F (30°C) Ambient / 32°F (0°C) Box Temperature

Evaporator Inlet	Evaporator Outlet	Suction Line	Compressor Top	Compressor Bottom	Condenser Inlet	Condenser Outlet
-24°F	-19°F	42°F	139°F	99°F	130°F	101°F
-31°C	-28°C	6°C	59°C	37°C	54°C	38°C

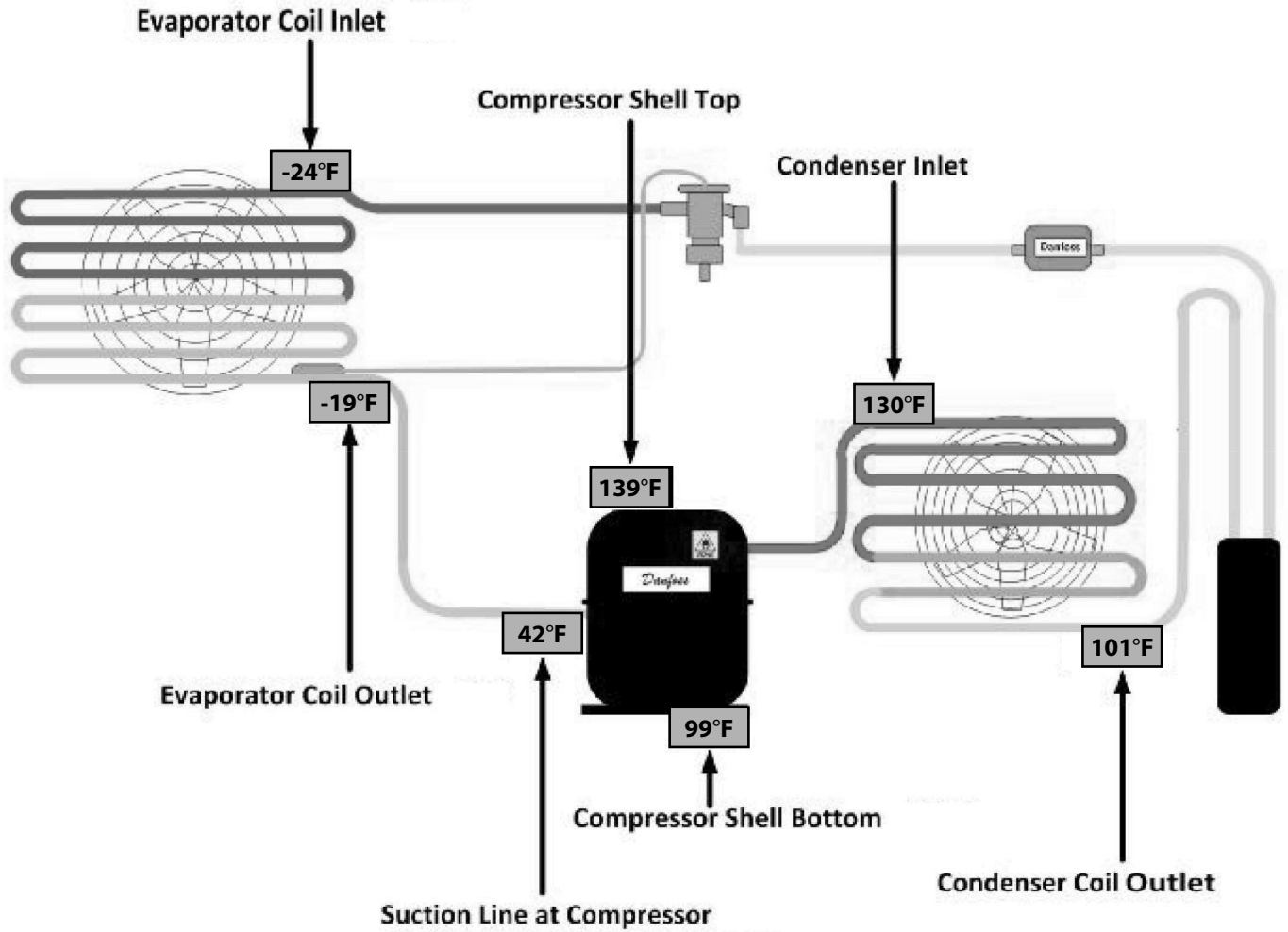

1 SECTION PASS-THRU FREEZER

100°F (38°C) Ambient / 32°F (0°C) Box Temperature

Evaporator Inlet	Evaporator Outlet	Suction Line	Compressor Top	Compressor Bottom	Condenser Inlet	Condenser Outlet
-23°F	-19°F	51°F	161°F	114°F	147°F	115°F
-31°C	-28°C	11°C	72°C	46°C	64°C	46°C

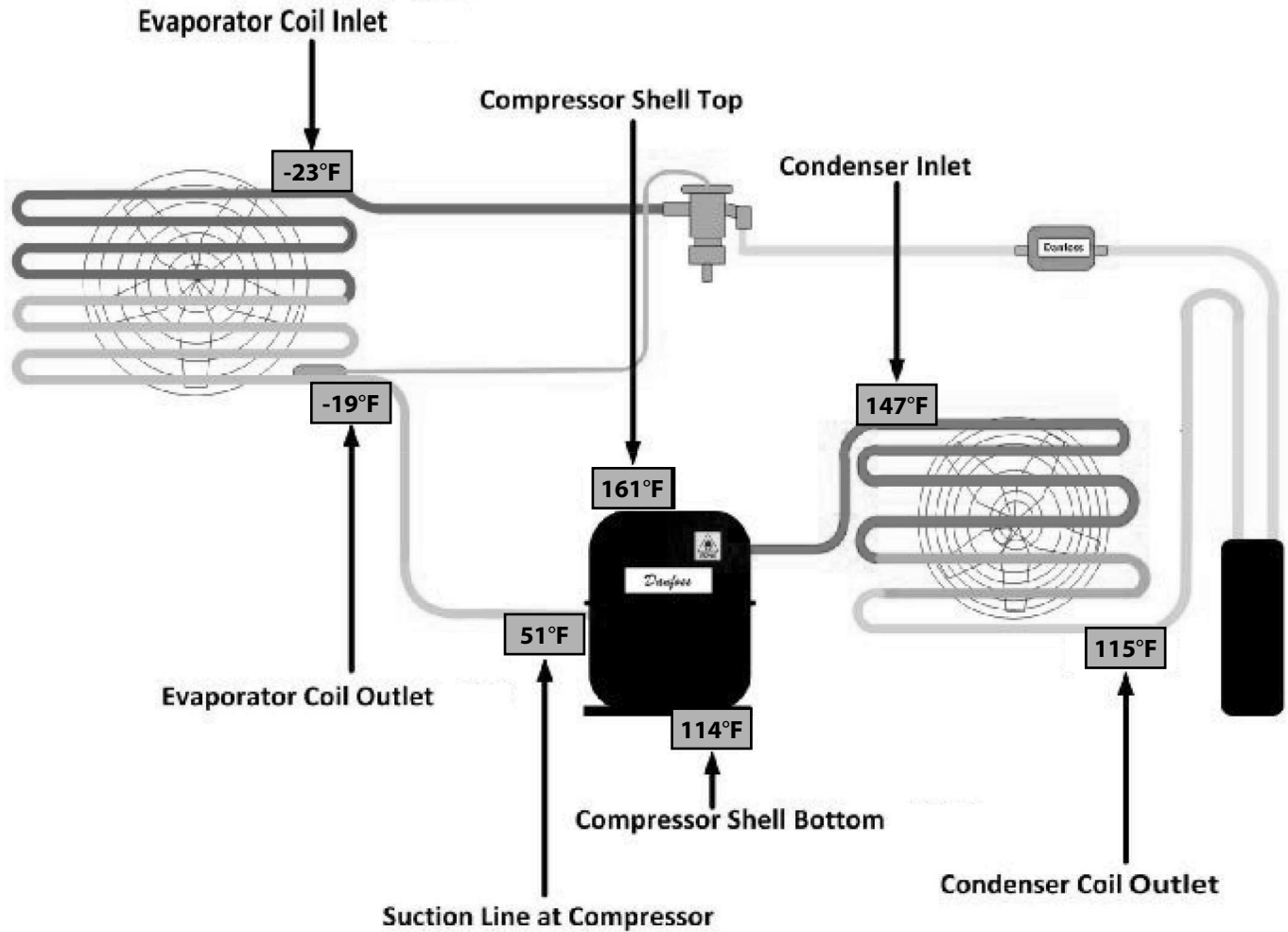

2 SECTION PASS-THRU FREEZER

75°F (24°C) Ambient / 32°F (0°C) Box Temperature

Evaporator Inlet	Evaporator Outlet	Suction Line	Compressor Top	Compressor Bottom	Condenser Inlet	Condenser Outlet
-21°F	-15°F	31°F	131°F	116°F	140°F	93°F
-29°C	-26°C	-1°C	55°C	47°C	60°C	34°C

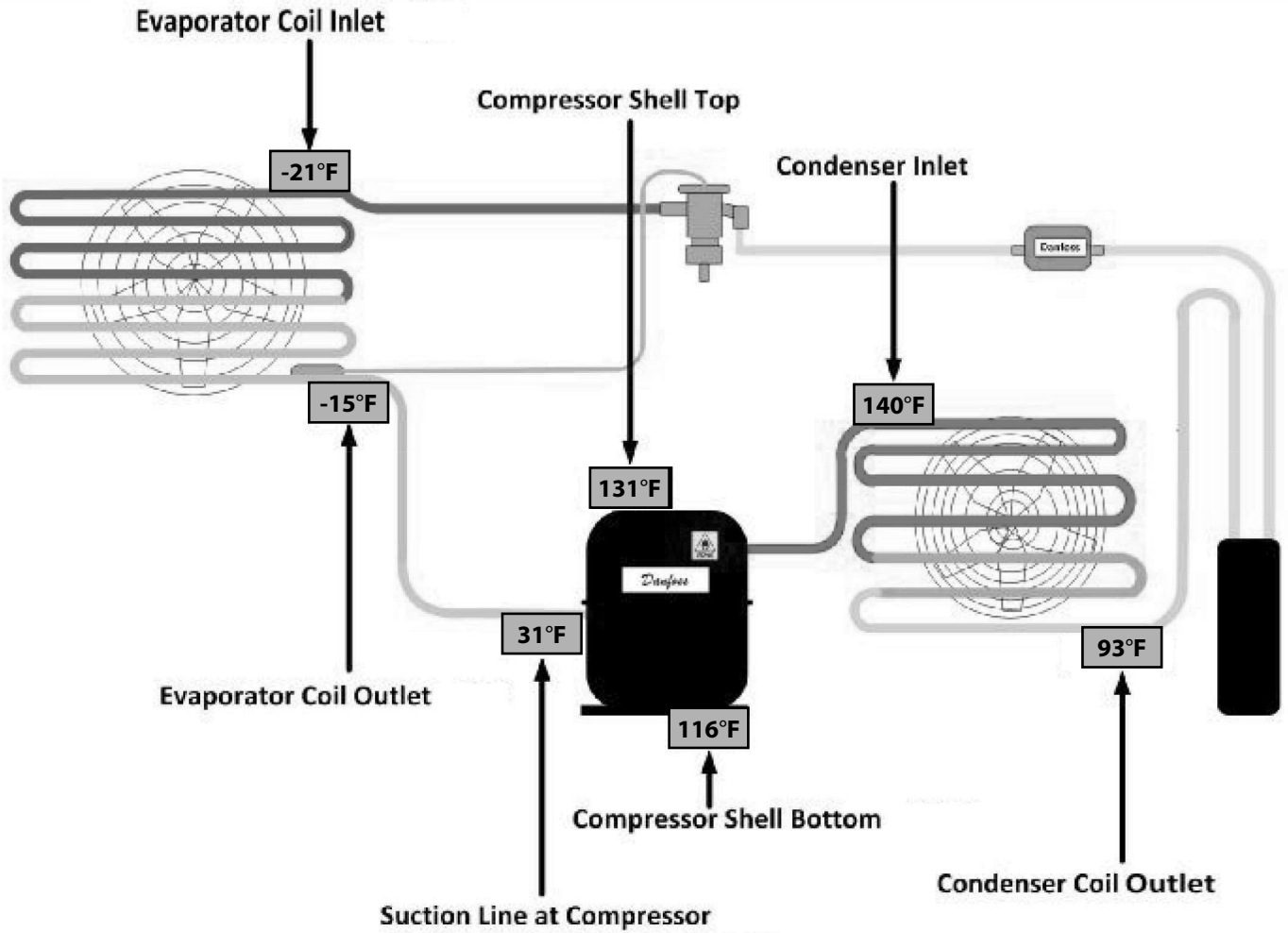

2 SECTION PASS-THRU FREEZER

86°F (30°C) Ambient / 32°F (0°C) Box Temperature

Evaporator Inlet	Evaporator Outlet	Suction Line	Compressor Top	Compressor Bottom	Condenser Inlet	Condenser Outlet
-21°F	-15°F	42°F	143°F	128°F	152°F	103°F
-29°C	-26°C	6°C	62°C	53°C	67°C	39°C

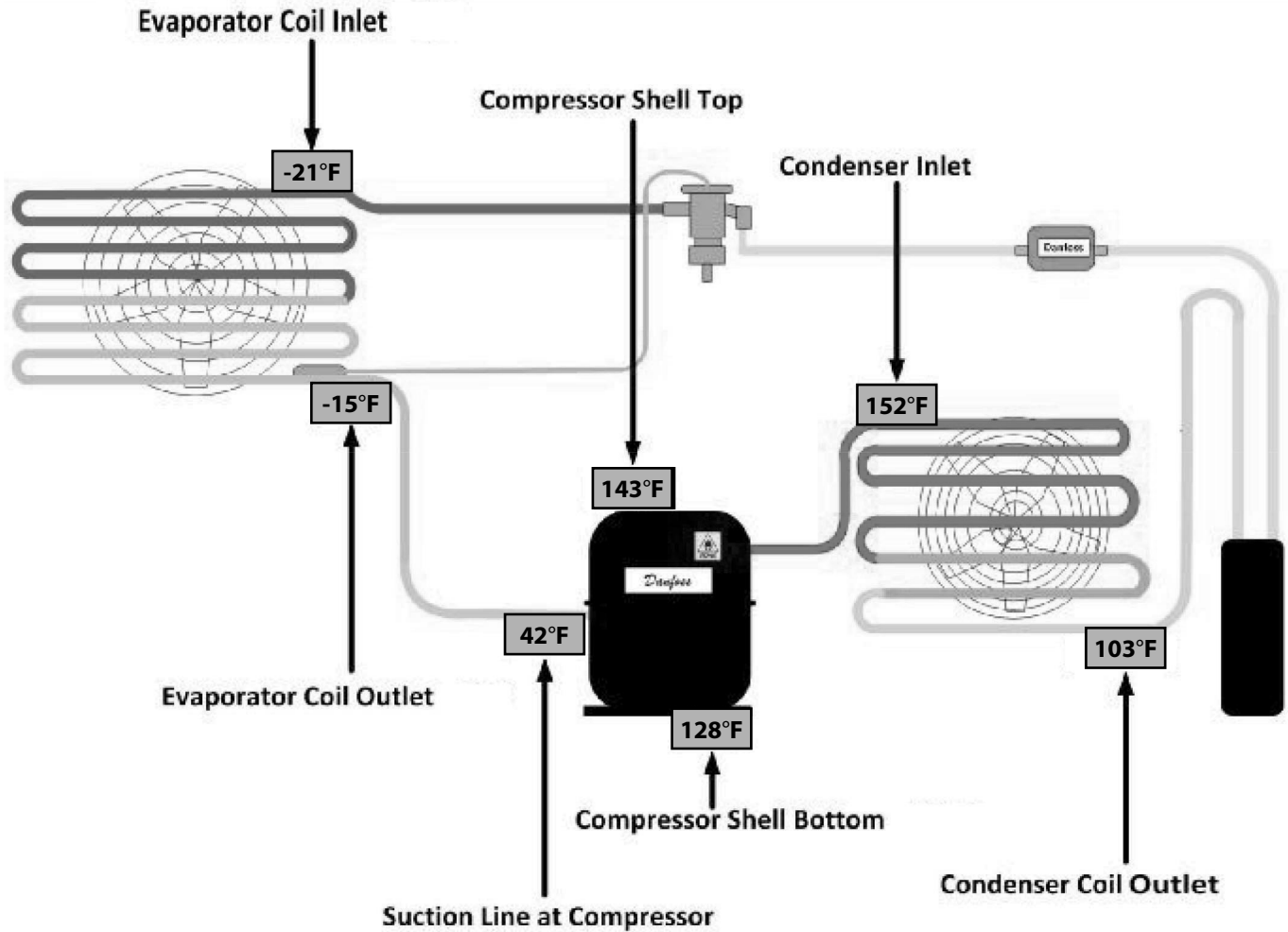

2 SECTION PASS-THRU FREEZER

100°F (38°C) Ambient / 32°F (0°C) Box Temperature

Evaporator Inlet	Evaporator Outlet	Suction Line	Compressor Top	Compressor Bottom	Condenser Inlet	Condenser Outlet
-20°F	-15°F	52°F	159°F	143°F	168°F	114°F
-29°C	-26°C	11°C	71°C	62°C	76°C	46°C

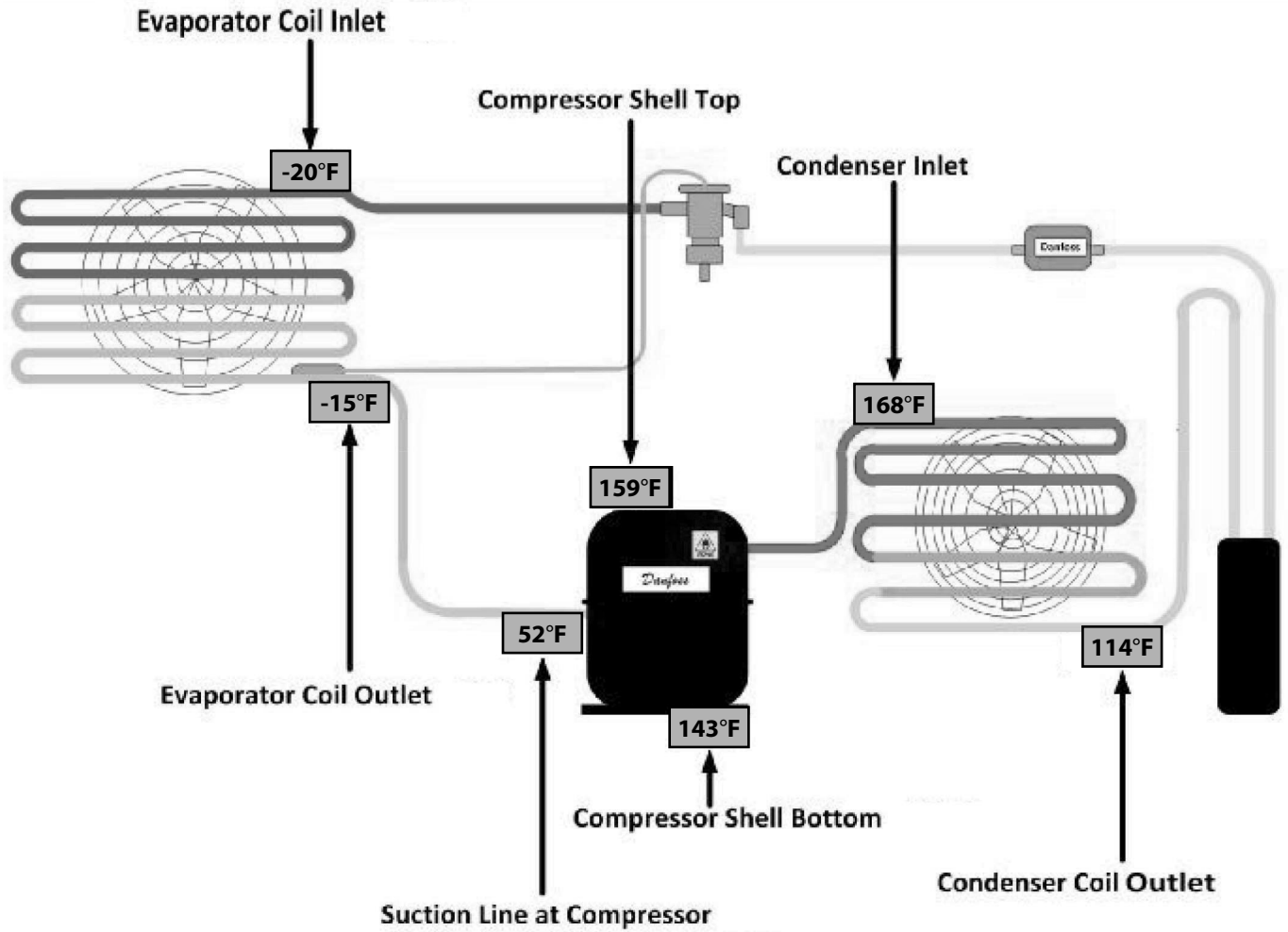

THIS PAGE INTENTIONALLY LEFT BLANK

Section 9 Diagrams

Refrigerator Wiring Diagram

Refrigerator Schematic

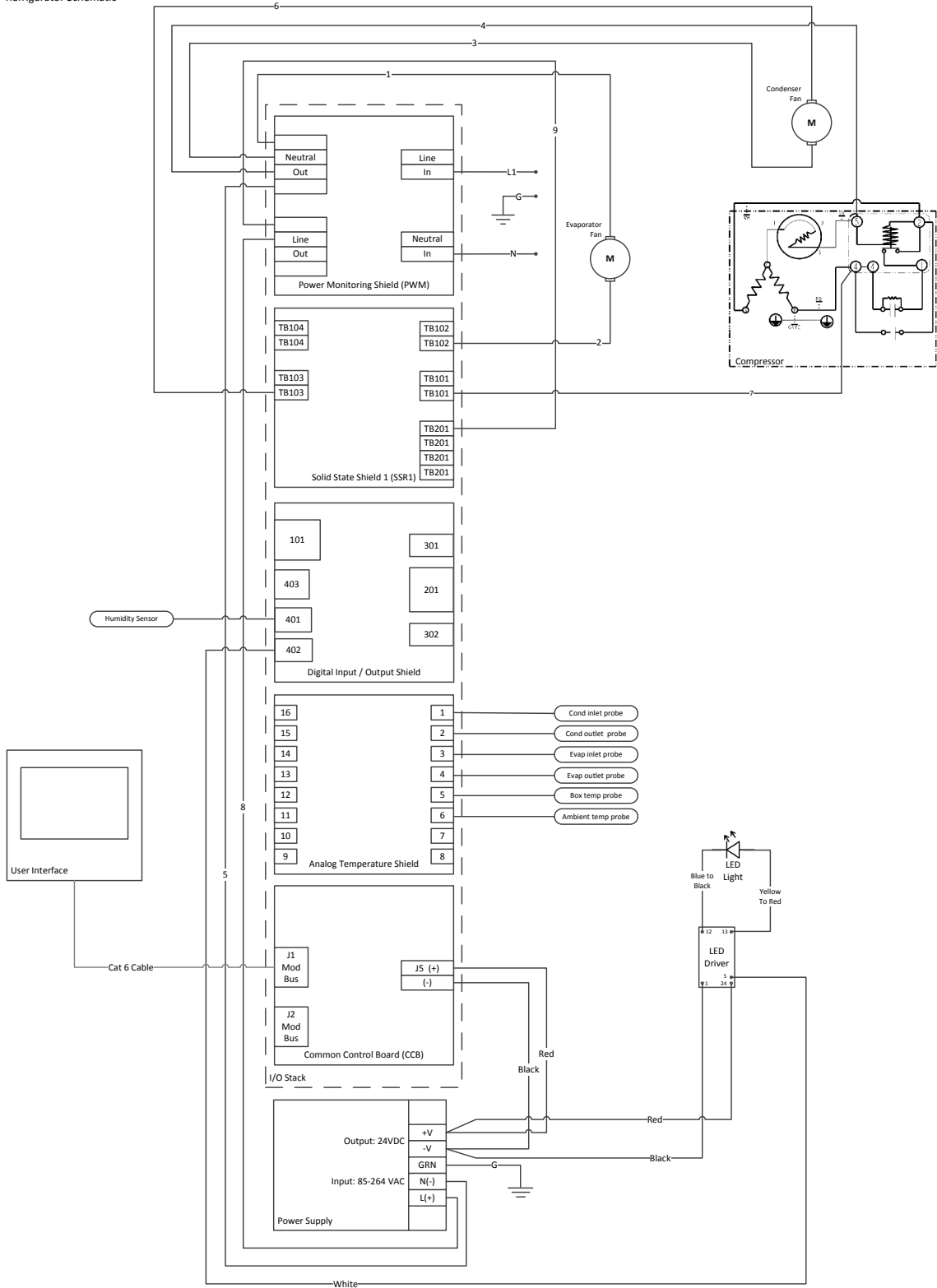

Freezers With One Compressor Wiring Diagram

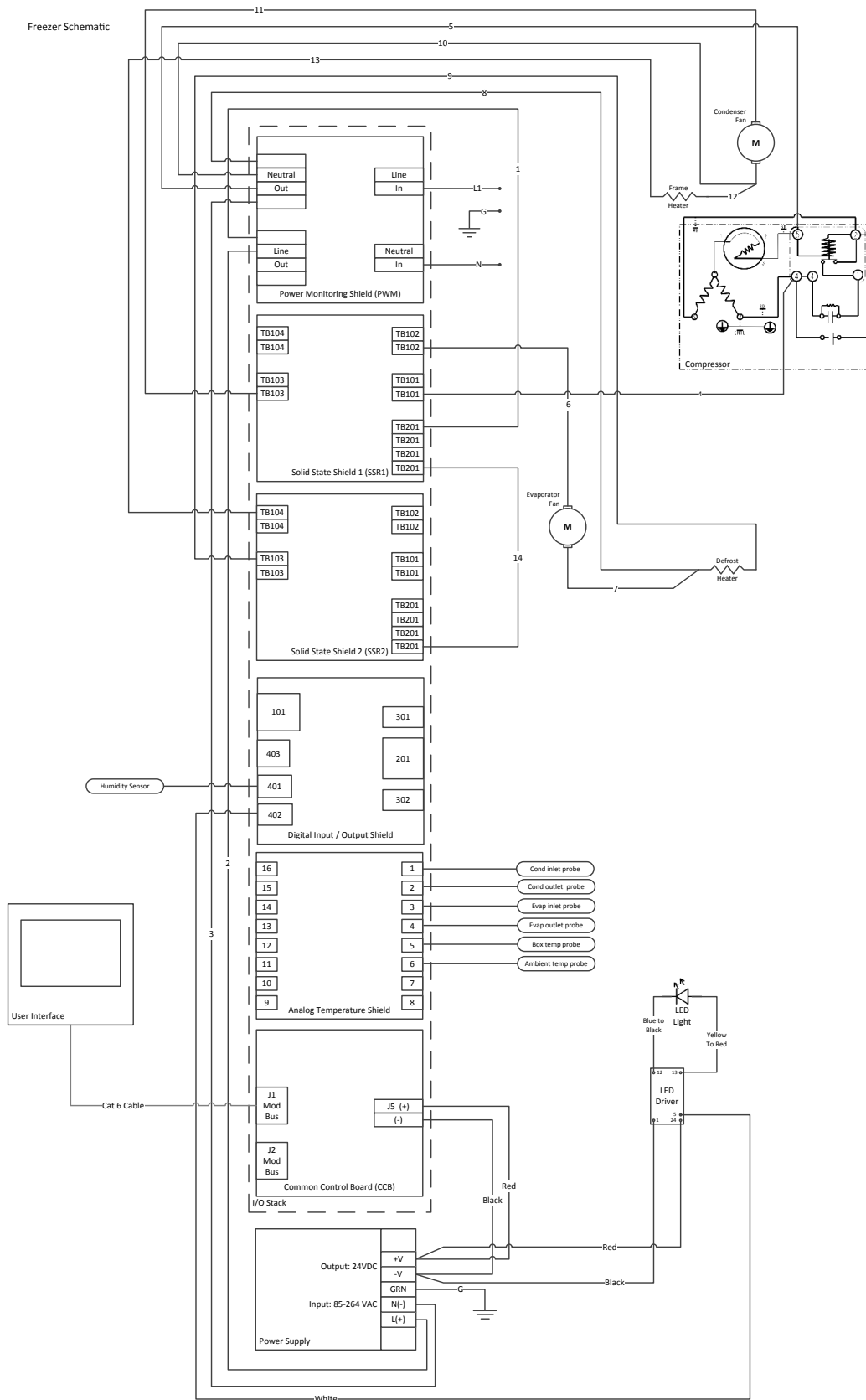

Freezers With Two Compressors Wiring Diagram

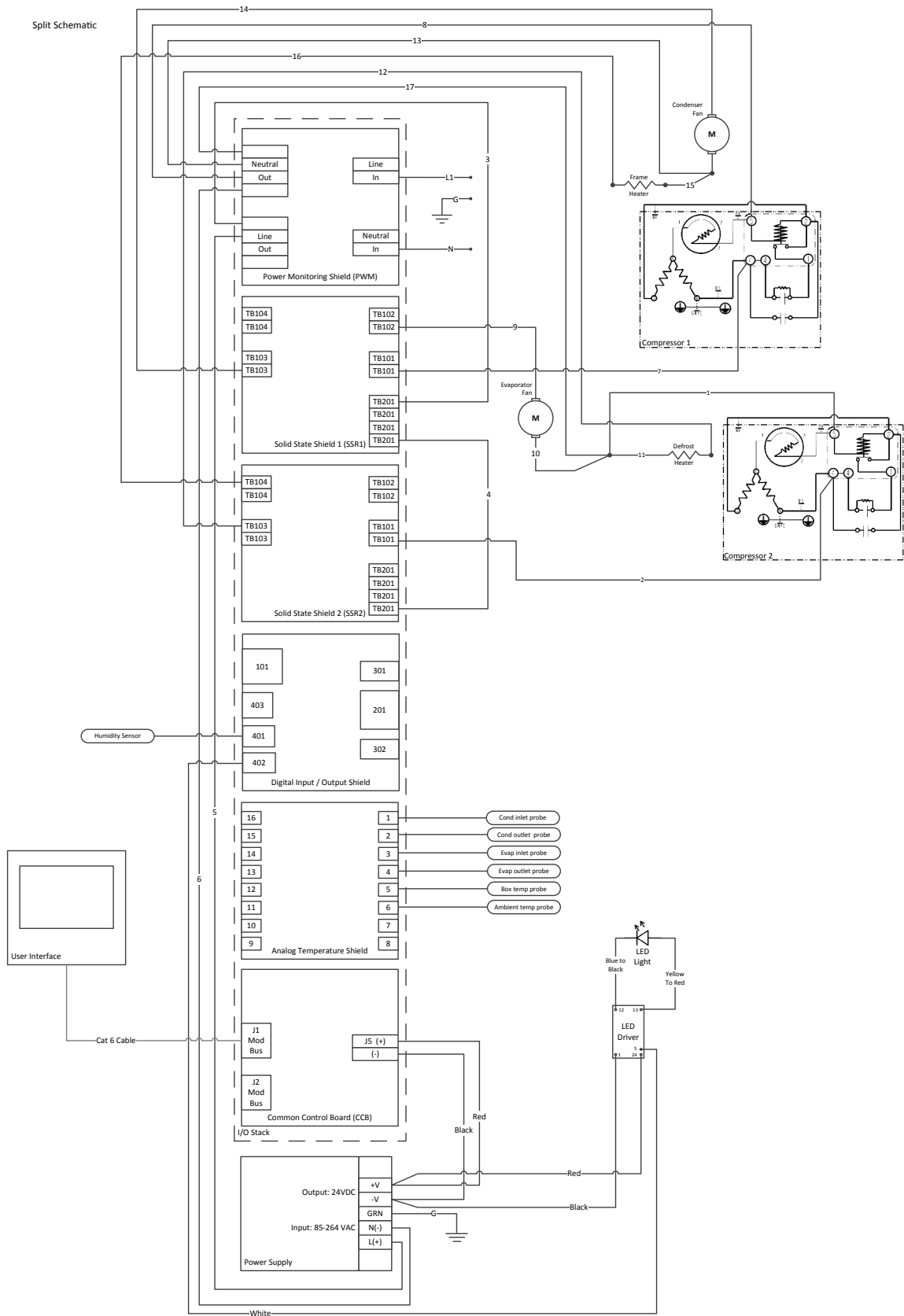

One Section Dual Temperature Wiring Diagram

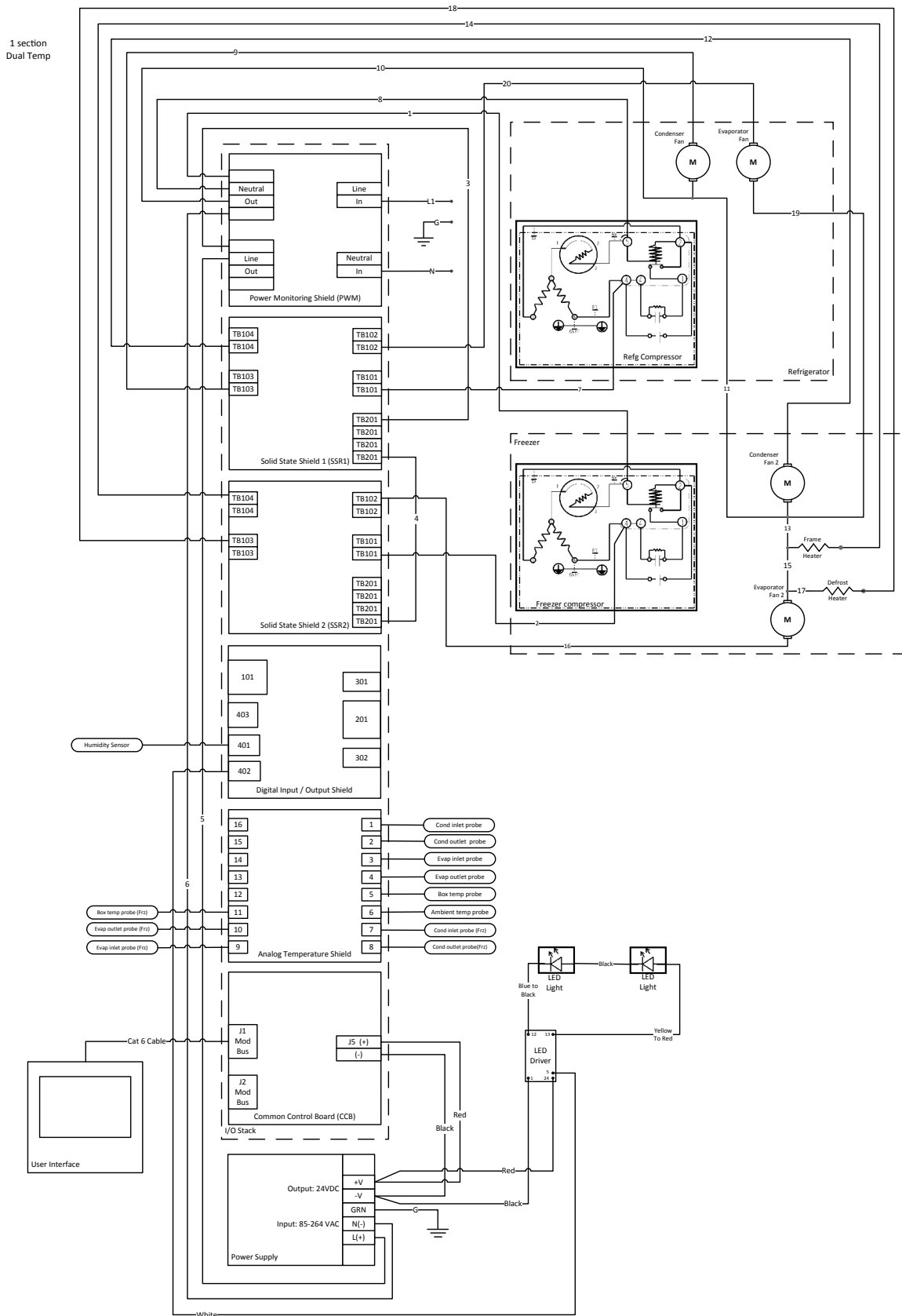

Two Section Dual Temperature Wiring Diagram

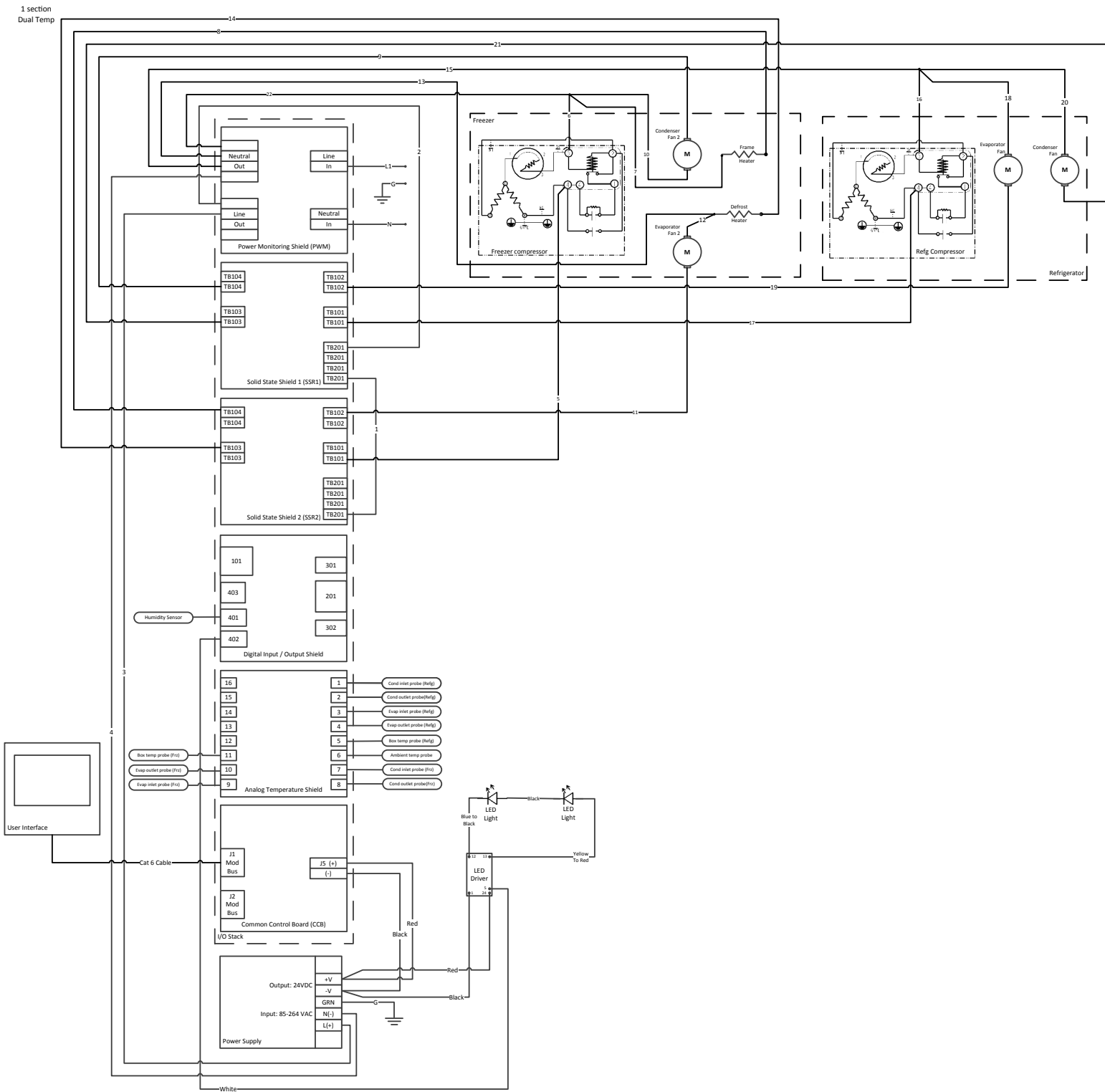

One Section Heated Cabinet Wiring Diagram

Heated Schematic

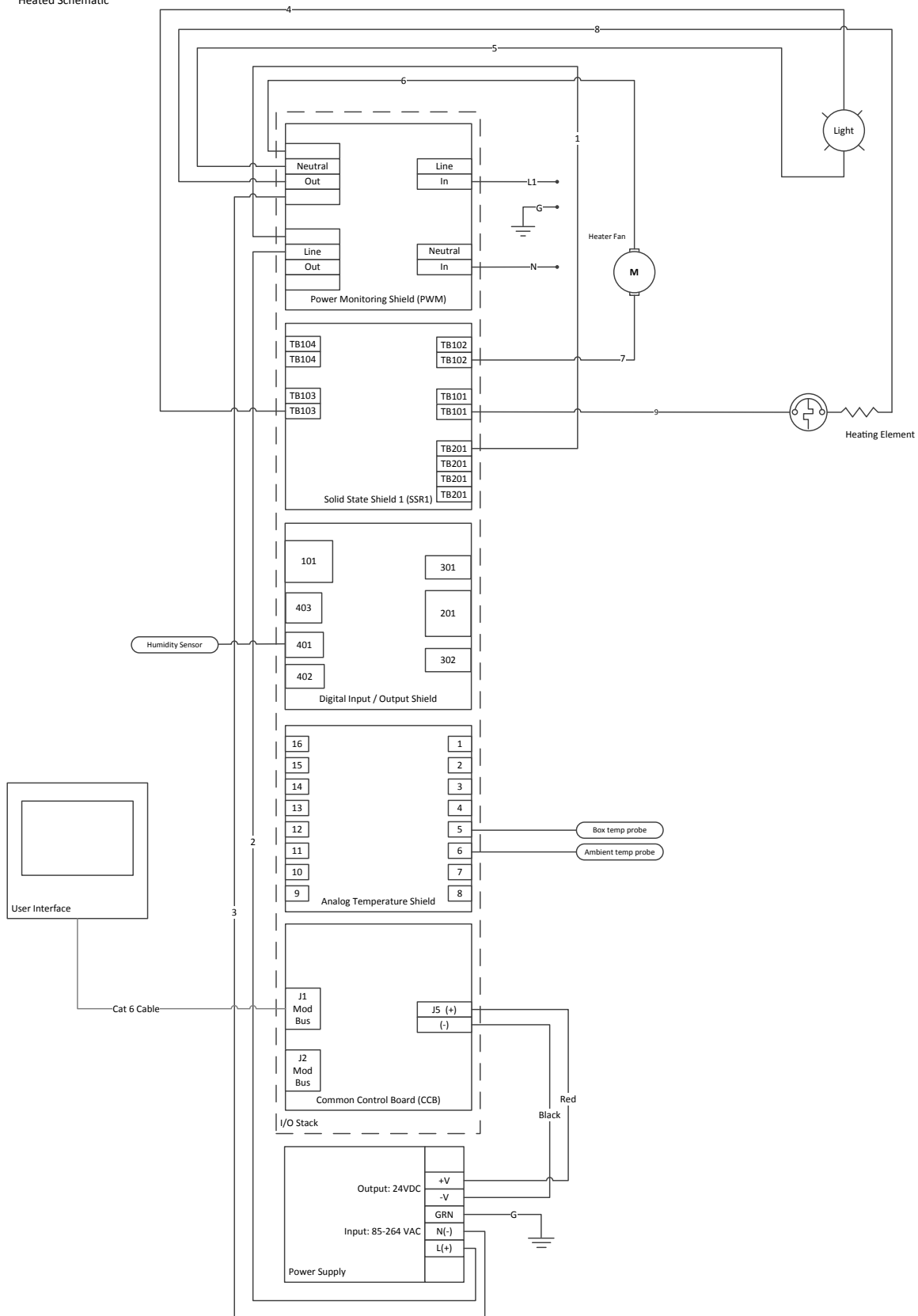

Two Section Heated Cabinet Wiring Diagram

Heated Schematic

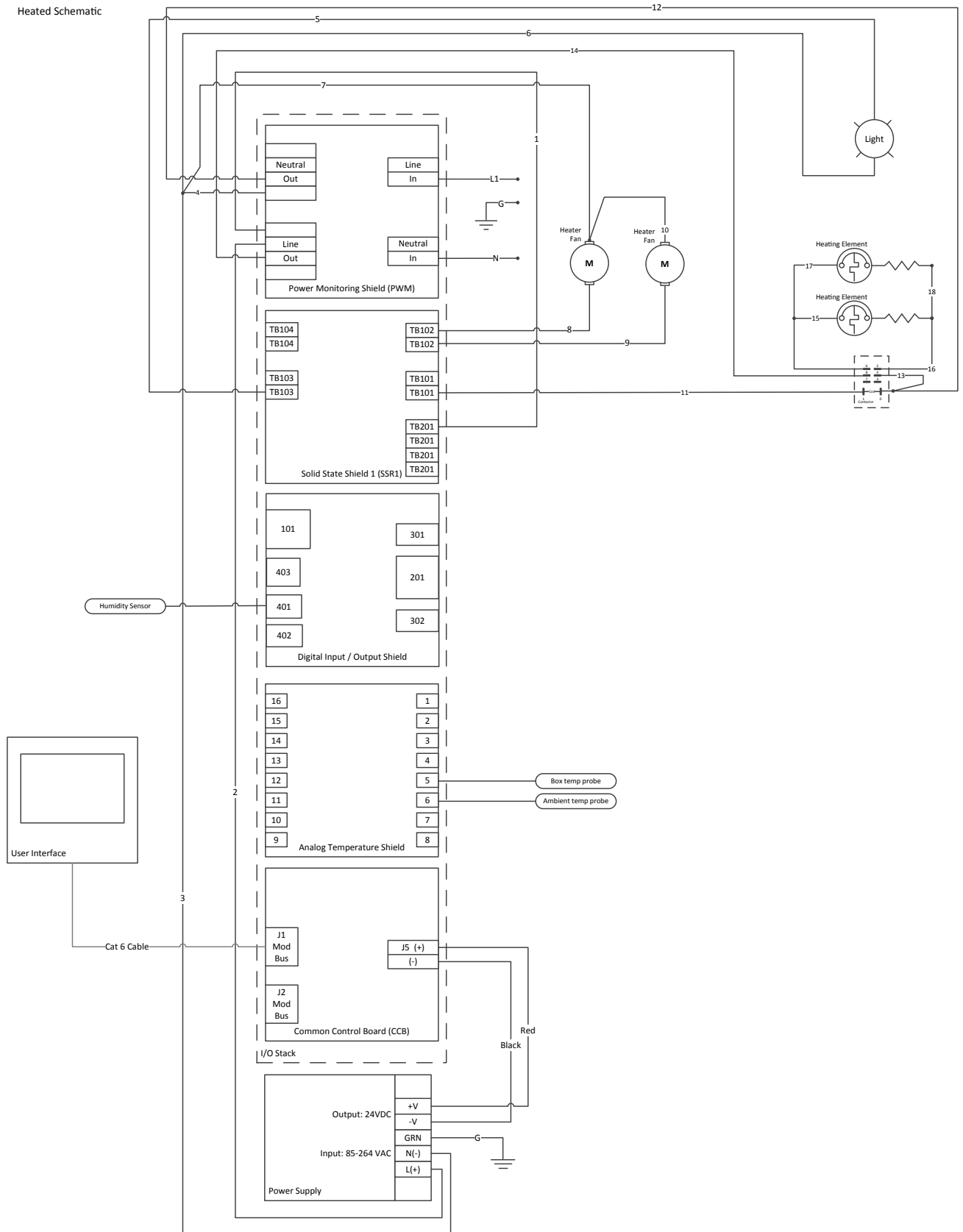

THIS PAGE INTENTIONALLY LEFT BLANK

**WWW.WELBILT.COM**

Welbilt provides the world's top chefs, and premier chain operators or growing independents with industry leading equipment and solutions. Our cutting-edge designs and lean manufacturing tactics are powered by deep knowledge, operator insights, and culinary expertise.

All of our products are backed by KitchenCare® – our aftermarket, repair, and parts service.

- | | | | | | |
|---------------|---------------|--------------|-----------|--------------|--------------|
| ▶ CLEVELAND | ▶ DELFIELD® | ▶ FRYMASTER® | ▶ KOLPAK® | ▶ MANITOWOC® | ▶ MERRYCHEF® |
| ▶ CONVOTHERM® | ▶ FITKITCHEN™ | ▶ GARLAND | ▶ LINCOLN | ▶ MERCO® | ▶ MULTIPLEX® |