

REFRIGERATOR MANUFACTURER
Turbo air
 more durable, efficient, beautiful

4184 E. Conant St.
 Long Beach, CA 90808
 Tel. 310-900-1000
 Fax. 310-900-1077
www.turboairinc.com

Project:	
Model #:	
Item #:	
Available W/H:	Qty:
Approval:	
AIA #:	SIS #:
CSI Section 11400	

Back Bars

*Underbar Equipment
 Super Deluxe Series*

Patented Self-Cleaning Condenser

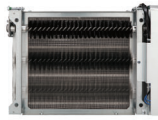

This product is equipped with a fine mesh filter to the front of the condenser to catch dust, and a rotating brush that moves up and down daily to remove excess buildup outward and away.

**Model : TBB-4SBD-N
 TBB-4SGD-N**



TBB-4SBD-N



TBB-4SGD-N

≡ FEATURES & BENEFITS ≡

- **Self-Cleaning Condenser**
 The accumulation of dust in the condenser can cause the failure or breakdown of refrigerators. Refrigerators run normally until they reach a certain level of accumulation. At some point, when they are over the limit, their performance drops quickly resulting in damage to, or disposal of the stored products inside. The Self-Cleaning Condenser device keeps the condenser clean and prevents system failure by automatically brushing daily.
- **Hydrocarbon refrigerants (R-290)**
 With innovative and eco-friendly technology, Turbo Air brings you hydrocarbon refrigerators designed to meet DOE's Energy Conservation Standards in 2017 and to use EPA's SNAP Program approved HC refrigerants. Hydrocarbon refrigerants do not deplete the ozone layer and have very low contribution to global warming (ODP-0, GWP-3).
- **Ergonomically designed doors**
 Customers' fatigue fades away with easy grip handles and doors that open effortlessly. These features along with self-closing doors make this the ultimate choice in customer convenience.
- **Stainless steel countertop and interior**
 The exterior of the cabinet is constructed with heavy gauge reinforced stainless steel countertop and wear-resistant black vinyl coated galvanized steel. The interior is painted galvanized steel with reinforced stainless steel floor. Turbo Air Back Bar model guarantees the utmost in cleanliness and long product life. It also adds a touch of style to the most refined setting.
- **Digital Temperature Controller**
 External digital temperature control has an easily accessible panel to quickly adjust temperatures, which includes a defrost control.
- **Forced air cooling system**
 Fast cooling and balanced temperature throughout the cabinet.
- **LED interior lighting**
- **Double pane glass doors with Low-E glass (SGD Models)**
- **High-density polyurethane insulation**
 The entire cabinet structure is foamed-in-place using high density, HCFC free polyurethane insulation.
- **Adjustable, heavy duty, PE (polyethylene) coated wire shelves**
- **Side mount compressor unit**
 With compressors positioned on the side of the unit, our refrigerators can now be serviced without being moved. Our innovative, front air intake feature also allows this model to be highly efficient in narrow spaces.
- **Refrigerator holds 33°F ~ 38°F for the best in beverage preservation**



Model	Swing Doors	CU./FT.	1/2 Barrels	#of Shelves	HP	AMPS	Crated Weight (lbs.)	L x D* x H† (inches)
TBB-4SBD-N	3	36.47	4	8	1/3	2.9	479	90 3/8 x 27 1/4 x 37 1/8
TBB-4SGD-N	3	36.47	4	8	1/3	3.6	545	90 3/8 x 27 1/4 x 37 1/8

Ver.20230103 Printed in U.S.A. * Depth does not include 3/8" (SBD) / 1-1/2" (SGD) for door handles. Depth does not include 1-1/4" for rear spacers. † Height does not include 3-1/8" for caster height.

Model : TBB-4SBD-N, TBB-4SGD-N

ELECTRICAL DATA		
Voltage	115/60/1	
Plug Type	NEMA 5-15P	
Full Load Amperes	2.9 (SBD) / 3.6 (SGD)	
Compressor HP	1/3	
Refrigerant	R-290	
Cord Length (ft.)	8.5	
Lamp (W)	12.5 x 2ea	
DIMENSIONAL DATA		
Capacity	1/2 Barrels	4
	cu. ft.	36.47
Ext. Length Overall (in.)	90 1/4 (2294mm)	
Ext. Depth Overall (in.)*	27 1/4 (692mm)	
Ext. Height Overall (in.)†	37 1/8 (942mm)	
# of Swing Doors	3	
# of Shelves (# of Sub Shelves)	6 (2)	
Shelf size (L x D) (in.)	(L) 26 1/2 x 19 3/8 / (M) 25 3/4 x 19 3/8 (R) 22 1/4 x 19 3/8	
# of Casters	 6EA	
Net Weight (lbs.)	442 (SBD) / 435 (SGD)	
Gross Weight (lbs.)	479 (SBD) / 545 (SGD)	

Design and specifications subject to change without notice.
Actual shipping weight may differ due to extra packing materials for product protection.
*Depth does not include 3/8" (SBD) / 1-1/2" (SGD) for door handles.
Depth does not include 1-1/4" for rear spacers.
† Height does not include 3-1/8" for caster height.

- **WARRANTY : 5 Year Parts and Labor Warranty**
7 Year Compressor Warranty

■ STANDARD FEATURES

- **Anti-corrosion coated evaporator**
- **Self-contained system**
- **2.5" dia. swivel casters with locks on the front set**
- **Door locks**

■ OPTIONAL ACCESSORIES

- 1" caster, 1/2" diameter & 13 TPI: S28R813660 (non-brake)
- 2" caster for underbar series, 1/2" diameter: P0165B0100 (non-brake), P0165B0110 (w/ brake)
- 4" caster: G8F6500101(non-brake), G8F6500201 (w/brake)
- 5" caster, 1/2" diameter & 13 TPI: M726500100 (non-brake), M726500200 (w/ brake)
- Leveling leg, 1/2" - 13 TPI x 1.54": LFM1213566
- 6" adjustable stainless steel leg: P0121P0100
- Additional PE coated wire shelf: P0178D0200 (L), P0178D0300 (M), P0178D0400 (R)

Ver.20230103

PLAN VIEW

(unit : inch)

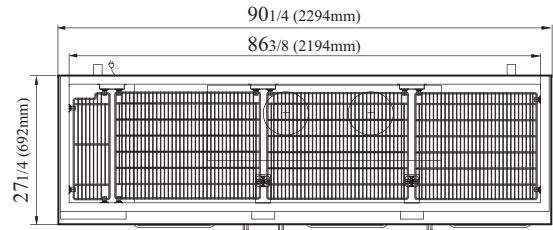

TOP VIEW

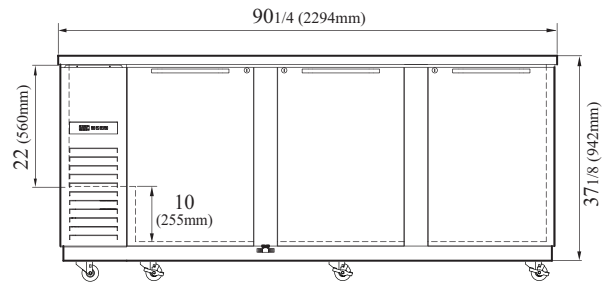

TBB-4SBD-N FRONT VIEW

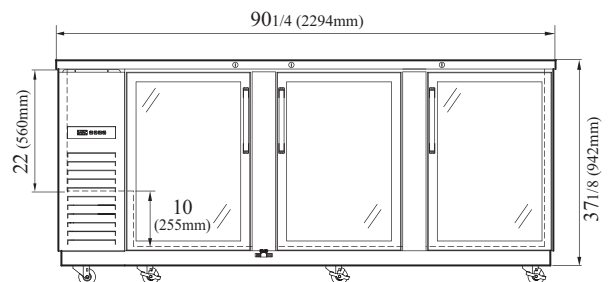

TBB-4SGD-N FRONT VIEW

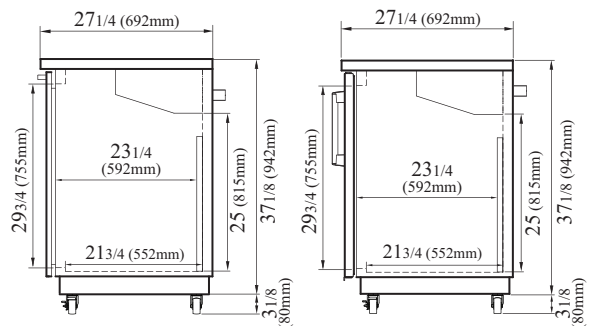

TBB-4SBD-N & TBB-4SGD-N SIDE VIEW

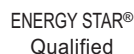

- Turbo Air : 800-627-0032
- GK : 800-500-3519
- Warranty : 800-381-7770
- AC : 888-900-1002

