

DURAPAN™ SERIES

GAS, OPEN OR MODULAR BASE,
30 & 40 GALLON (115 & 150 LITER)

Project _____
Item _____
Quantity _____
FCSI Section 11400 _____
Approved _____
Date _____

Braising Pans / Tilting Skillets

Models

- SGL-30-TR • SGM-30-TR
- SGL-40-TR • SGM-40-TR



Open base model shown

- Adjustable, Electronic Thermostat controls temperature from 100°F to 425°F
- High Efficiency Heating System with even heat distribution
- Electronic Spark Ignition (ESS)
- Fast Heat-Up and Recovery Time-Preheats in 11 minutes, full capacity from cold to boiling in 60 minutes
- Spring Assist Cover with Adjustable Vent and Full Width Handle
- On/Off Switch, Thermostat Knob and Pilots, recessed to avoid breakage
- Four Stainless Steel, Level adjustable feet, rear flanged for bolting
- All Controls are serviceable from the front of the unit
- Two pilot lights; Green = Power on, Amber = Temperature Cycling
- Meets IPX6 Water Rating Requirements
- High Limit Safety Device set at 475°F (246°C)
- Anti-Splash Pouring Lip
- Supplied with Cord & Plug for 115-volt controls
- Typical approvals include AGA, CSA, CE and NSF

Short Form Specifications

Shall be CLEVELAND, Tilting Skillet;
Model SG _____ - _____ - TR gas
(TYPE _____) - holding no less than _____
gallons (_____ liters); complete with
Thermostatic Safety and Gas Controls; Gallon
Markings; Stainless Steel Clad 5/8" Cooking
Surface; Hand Tilt; Spring Assist Cover with
adjustable Vent. All Stainless Steel
Construction.

Standard Features

- Leg or Modular Base
- Full 30/40 Gallon (115/150 Liters) Capacity Rating to Bottom of Pouring Lip
- Hydraulic Hand Tilt with quick lowering feature (HTS)
- Stainless Steel Clad 5/8" Cooking Surface Guaranteed against warping
- Stainless Steel Covered Cornered Pans with both Gallon and Liter Markings
- All Stainless Steel Construction for durability and easy cleaning

Options & Accessories

- Sliding Drain Drawer with Splash Screen (SLD) (for SGL models only)
- Power Tilt with Hand Tilt Override (PT1)
- Double or Single Pantry Faucet (SPS14, DPS14), includes Faucet Mounting Bracket
- Double or Single Pantry Skillet Filler with 60" hose (SKF-S or DKF-S)
- Hot & Cold Water Pre-Rinse Spray Head with Hose (PRS-S)
- Gas types other than natural
- Voltage Option:
 - VOSK4, 220/240 Volt, 50 Hz, 1 Phase - for export
- Food Strainers for pouring spout (FS)
- Vegetable Steamers (VS)
- Poaching Pans (PP)
- Wall Mounting (WMS)
- In-Wall Carrier (IWCS)
- Pan Carriers (PCS), not available on 30 gallon models with a Tangent Draw-Off Valve
- 2" Tangent Draw-Off Valve (TD2), left side only

KE004046-93 rev B

DIMENSIONS

MODEL	A	B	C	D	E	G
SGL-30-TR	36"	32"	9"	5"	20"	32 7/8"
	(915mm)	(812mm)	(229mm)	(127mm)	(508mm)	(835mm)
SGL-40-TR	48"	44"	12 1/8"	8"	22"	44 7/8"
	(1220mm)	(1118mm)	(308mm)	(203mm)	(559mm)	(1140mm)

CAPACITIES

In 4 oz. servings. Other sizes may be calculated.
 30 gallons / 115 Liters 960
 40 gallons / 150 Liters 1280

SPECIFICATIONS

ELECTRICAL SUPPLY (6' CORD & PLUG)		GAS SUPPLY (PIPING 3/4" NPT)		CLEARANCE	
VOLTS: 120	220/240	TYPE: NAT or LP	MIN. TO COMBUSTABLE SURFACES: SIDES: 0, REAR: 6" (153mm)		
PHASE: 1	1	WATER COLUMN: 4.5 (NAT), 10.5 (LP)	MIN. TO NON COMBUSTABLE SURFACES: SIDES & REAR: 0		
AMPS: 1.8	.83	BTU PER CU. FT.: 1000 (NAT), 2500 (LP)	NOTE: 4 1/2" (115mm) required on right hand side for faucet		
FREQ.: 60 HZ	50 HZ	SUPPLY PRESSURE: 5" W.C. MIN (NAT), 11" W.C. MIN (LP)			
		BTU RATINGS:			
		SGL-30-TR: 91,000 per hour			
		SGL-40-TR: 130,000 per hour			

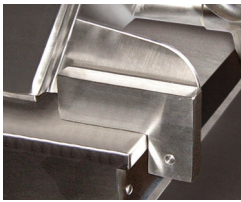

 EXTERIOR HINGES
(REQUIRED FOR
OPTIONAL TD 2)

Shipping Weights & Dimensions

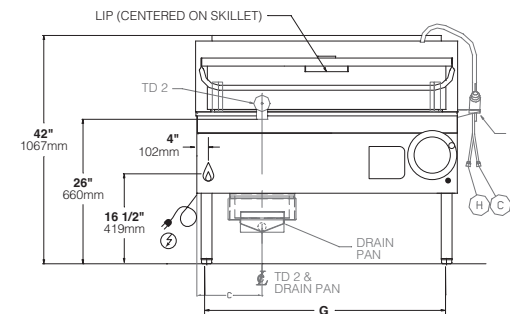
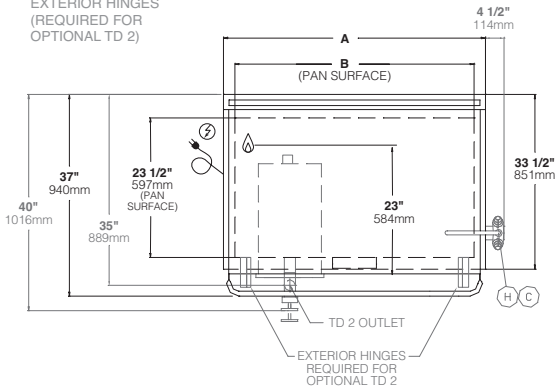
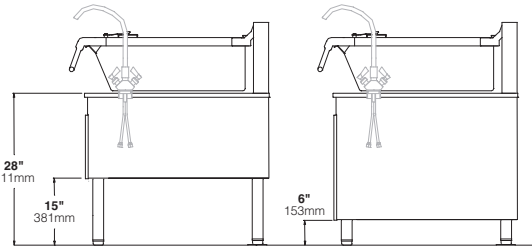
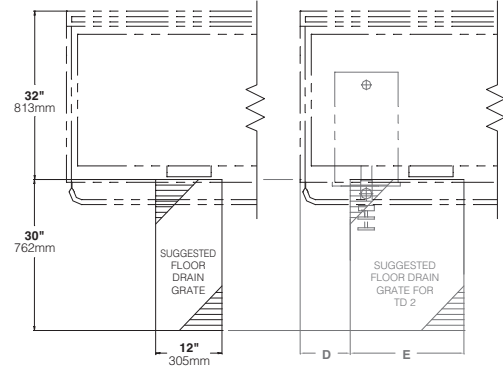
Model -
SGL30TR Weight - 504 lbs
 Width - 44"
 Depth - 44"
 Height - 54"
SGL40TR Weight - 624 lbs
 Width - 48"
 Depth - 58"
 Height - 54"

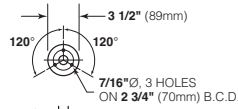

NOTE: NON STANDARD ITEMS ARE SHOWN IN GRAY

FLANGED FOOT DETAIL
(REAR LEGS ONLY)

1" (26mm) (MAXIMUM) ADJUSTMENT

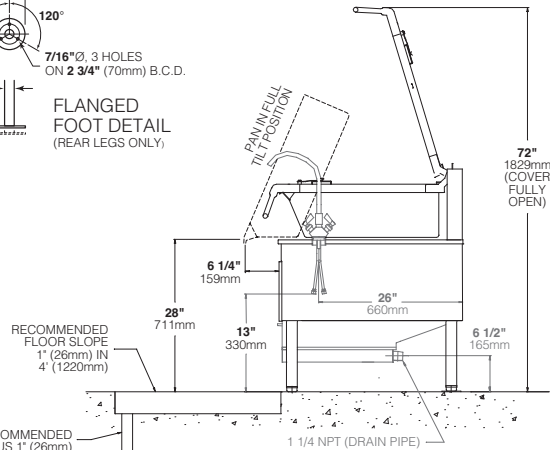
NOTES:

Cleveland Range reserves right of design improvement or modification, as warranted.
 Many regional, state and local codes exist and it is the responsibility of the owner and installer to comply with the codes.
 Cleveland Range equipment is built to comply with applicable standards for manufacturers. Included among those approval agencies are U.L., NSF, CGA, CSA, ETL and others.

(NOT TO SCALE)