

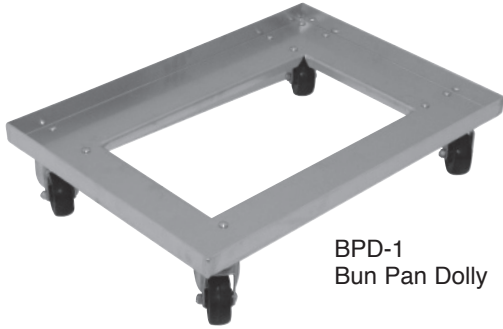

ALUMINUM

DOLLIES & TRUCKS

Bun Pan Dolly - Glass Rack Dolly - Pan Truck



BPD-1
Bun Pan Dolly



PD-1
Pan Truck



GRD-1
Glass Rack Dolly

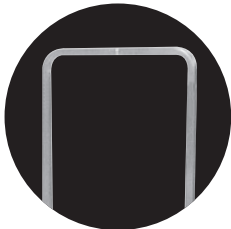

Optional
Glass Rack Dolly Handle
(Assembly Required)
RA-14

Item #:	_____	Qty #:	_____
Model #:	_____		
Project #:	_____		

FEATURES:

BUN PAN DOLLY:

Heavy duty welded construction. Holds 60 full size pans. 3" bolted plate casters. 600 lbs. weight capacity.

PAN TRUCK:

Curved top design. Heavy duty welded construction. Holds 60 full size pans. 3" bolted plate casters. 600 lbs. weight capacity.

GLASS RACK DOLLY:

Heavy duty welded construction. 3" bolted plate casters. 600 lbs. weight capacity.

CONSTRUCTION:

Fully welded construction.

MATERIAL:

Heavy duty gauge aluminum plate, 6063-T52 extruded upright tubing (PD-1).

MODEL #	Wt.	Qty
BPD-1 Bun Pan Dolly	15 lbs.	
GRD-1 Glass Rack Dolly	14 lbs.	
PD-1 - Pan Truck	20 lbs.	

Accessory	Model #	Qty
Glass Rack Dolly Handle	RA-14	



Customer Service Available To Assist You **1-800-645-3166** 8:30 am - 7:00 pm E.S.T.

For Orders & Customer Service:
Email: customer@advancetabco.com or Fax: 631-242-6900

For Smart Fabrication™ Quotes:
Email: smartfab@advancetabco.com or Fax: 631-586-2933

DIMENSIONS and SPECIFICATIONS

TOL ± .500"

ALL DIMENSIONS ARE TYPICAL

BPD-1

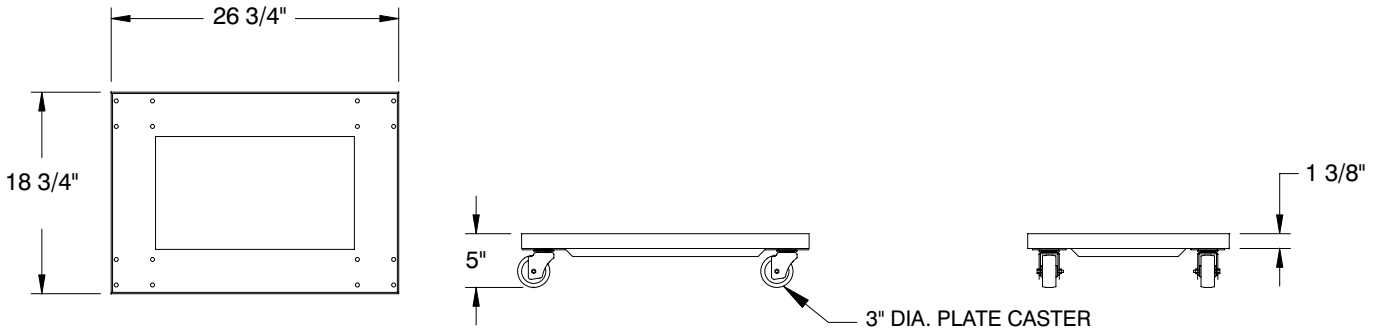

PD-1

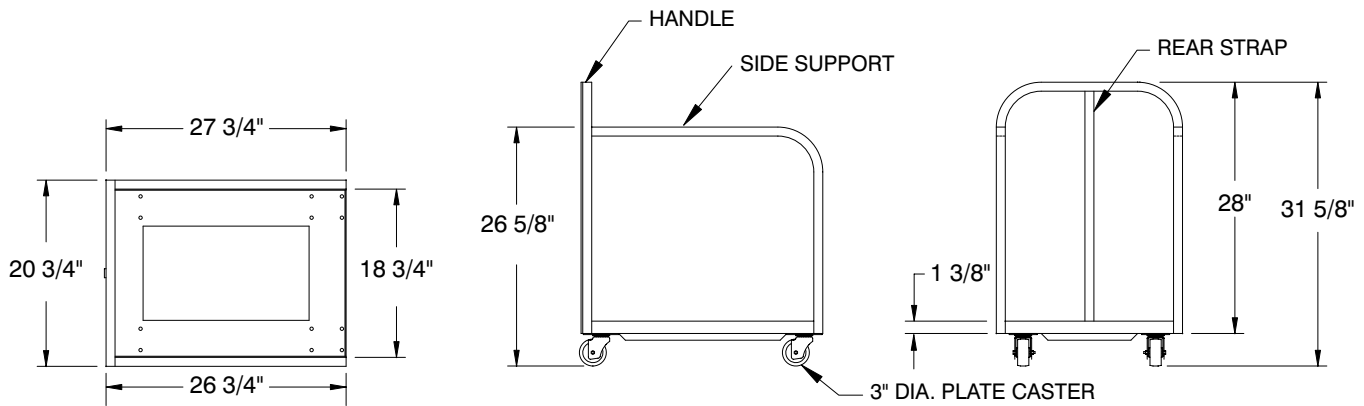

GRD-1

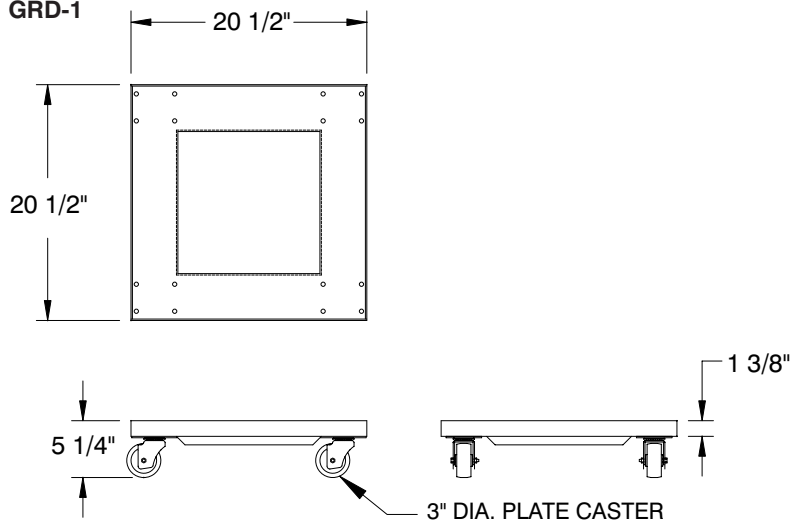

Optional Glass Rack Dolly Handle (Assembly Required) RA-14

