

flexeserve™

Operation Manual



Flexeserve Zone

3, 4, 5 Tier - Floor Standing

Models 400 | 600 | 1000

North America

Flexeserve Customer Support

Call Toll-Free 833 955 8300

customer.support@flexeserve.com



Contents	
Introduction	3
Safety Symbols	4
Safety Instructions	5
Specifications	6
Overall Dimensions	7-9
Installation	10
Positioning	11
Moving	11
Electrical Connection	12-13
Equipment Configuration	13
Power ON/OFF	14
Switching On	15-16
Switching Off	17
Operation	18
Display and Merchandising	19
Product Probing	19
Daily Cleaning	20
Troubleshooting	21
Spare Parts and Service	22
Disposal of this Equipment	22
Contact Us	23

Introduction

This manual has been developed as a guide to assist with the continued safe operation of the equipment.

The document covers many aspects of use and maintenance; the relevant level of training and competence is required from the operators working with the equipment.

The Alan Nuttall Partnership Ltd cannot be held responsible for any accidents or injuries caused by instructions being carried out incorrectly or by the way the information is depicted. The manual must be read and understood before using the equipment.

This manual has been composed with the utmost care. However, as the result of a constant commitment to development and improvement, it may be the case that your equipment deviates in detail from what is described in this manual.

The following instructions are only intended as guidelines for the installation, operation and maintenance of the equipment. Furthermore, The Alan Nuttall Partnership Ltd accept no liability whatsoever for loss or injury caused by the failure to strictly adhere to the safety guidelines and instructions in this manual, whether due to carelessness, lack of the relevant training, qualification or competence, and during installation, operation, maintenance or repair of the equipment.

This manual should be retained for future use.

Model numbers relating to this operation manual include:

- FXZNA10S3C-SF61
- FXZNA10S3S-SF61
- FXZNA10S3S-HL61
- FXZNA10S4C-SF61
- FXZNA10S4S-AM61
- FXZNA10S4S-AV61
- FXZNA10S4S-SF61
- FXZNA10S4S-ST61
- FXZNA10S5S-AM61
- FXZNA10S5S-PR61
- FXZNA10S5S-SF61
- FXZNA10S5S-ST61
- FXZNA40S3C-SF61
- FXZNA40S3S-SF61
- FXZNA40S4C-SF61
- FXZNA40S4S-SF61
- FXZNA60S3C-SF61
- FXZNA60S3S-HL61
- FXZNA60S3S-SF61
- FXZNA60S4C-SF61
- FXZNA60S4S-SF61
- FXZNA60S5S-SF61

© 2022 The Alan Nuttall Partnership Ltd

Do not copy without written permission from The Alan Nuttall Partnership Ltd. All contents of this document remain the intellectual property of The Alan Nuttall Partnership Ltd.

Safety Symbols

The symbols defined below, which are relied upon for safety, are used on Flexeserve Zone and/or throughout this document.



WARNING/CAUTION

An appropriate safety instruction should be followed or caution to a potential hazard exists.



DANGEROUS VOLTAGE

To indicate hazards arising from dangerous voltages.



HEAVY

This product is heavy and reference should be made to the safety instructions for provisions of lifting and moving.



HOT SURFACE

To indicate that the marked item can be hot and should not be touched without taking care.



INFORMATION

Information provided for trained and skilled operators only.



MAINTENANCE

Maintenance of the equipment must only be undertaken by fully trained, qualified and competent engineers.



PROTECTIVE EARTH (GROUND)

To identify any terminal that is intended for connection to an external conductor for protection against electric shock in case of a fault, or the terminal of a protective earth (ground) electrode.



WASTE OF ELECTRICAL AND ELECTRONIC EQUIPMENT

When the end user wishes to discard this product, it must be sent to separate collection facilities for recovery and recycling.

Safety Instructions

- This equipment may only be used by trained and skilled personnel. Any application that does not conform to the specified use is considered hazardous.
- The equipment must only be used for its intended purpose; any other application will be considered improper. Flexeserve Zone is designed to hot-hold food that has been cooked prior to display only. The equipment is not for cooking.
- Heated areas of Flexeserve Zone exceed 158°F (70°C): only touch the components used to control the equipment.
- Food products are to be pre-cooked to the appropriate temperature and displayed in suitable containers/packaging.
- Do NOT place anything heavier than 44lbs (20kg) on to the display surface.
- Do NOT cover or block exhaust vents or fan plates.
- This appliance can be used by children aged from 8 years and above, and persons with reduced physical, sensory or mental capacities, or lack of experience and knowledge if they have been given supervision or instruction concerning use of the appliance in a safe way and understand the hazards involved.
- Children should not be allowed to play with or be near the equipment.
- Before using the equipment:
 - Inspect the power cable for damage. If damaged, disconnect and isolate Flexeserve Zone;
 - If the glass display shelf is cracked, isolate Flexeserve Zone and remove from service;
 - Ensure that there are no foreign or combustible objects other than approved Flexeserve Zone accessories or approved food packaging in contact with the heated surfaces;
 - Ensure that the glass shelf surface is checked for signs of damage. If any damage is found, isolate the electrical supply and report to Flexeserve Customer Support Department.
- Switch off the appliance:
 - When not in use;
 - Before carrying out any maintenance task, such as cleaning;
 - Before moving the equipment.

To ensure that the equipment remains in optimum technical condition, maintenance work should be carried out at least once a year by an approved Flexeserve Service Provider.

The end user is fully responsible for the fulfilment of locally applicable safety regulations and guidelines at all times.

Any safety symbols, warnings and/or instructions attached to the equipment are part of the safety features. They must not be covered or removed, and must be present and legible during the life of the product. Immediately replace damaged or illegible symbols, pictograms, warnings and instructions.

Specifications

The Flexeserve Zone range of products detailed within this manual is a series of 3 tier, 4 tier and 5 tier floor standing heated displays for the presentation of pre-cooked food products in a suitable container or packaging in commercial outlets.

The Flexeserve Zone floor standing models are provided with 3, 4 or 5 fixed position heated zones.

Each zone maintains the food products to a fixed temperature between 149°F (65°C) and 194°F (90°C) by means of an air circulation heater.

NOTE

Each Flexeserve Zone will be factory set to maintain a minimum of 185°F (85°C) air temperature in each zone.

Flexeserve Zone floor standing models are supplied on castors; the front brake castors can be locked when the unit is in position.

The Flexeserve Zone range is cord connected and supplied with an appropriate cord set, and for indoor use only.

The ambient conditions required to operate the equipment are between 65°F (18°C) to 104°F (40°C), with a maximum relative humidity of 70%.

Overall Dimensions - 3 Tier Curved/Square

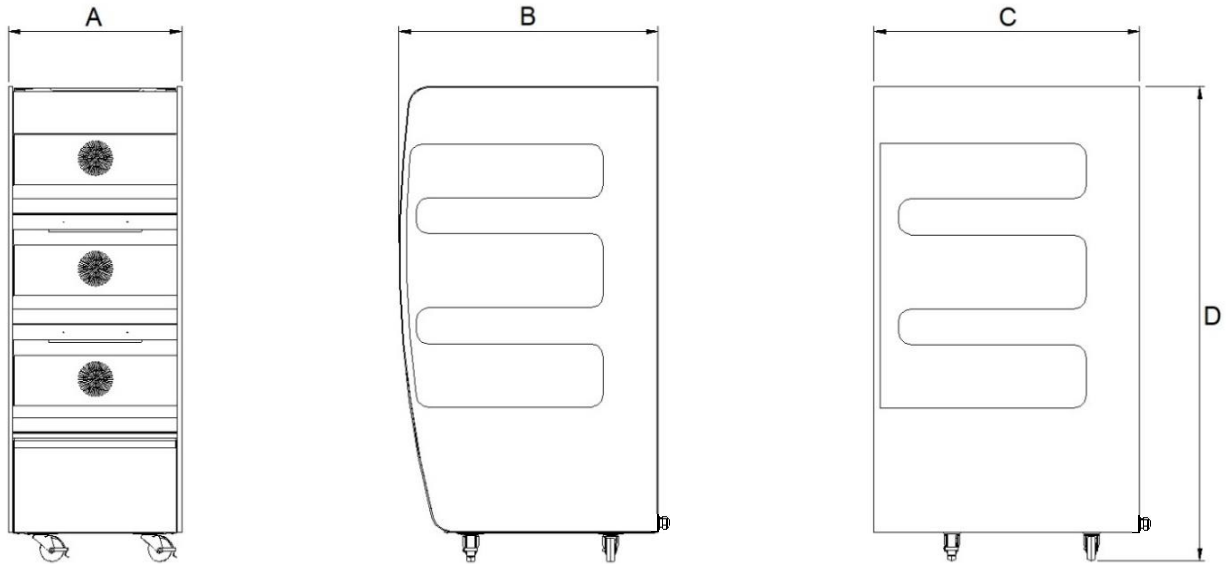

MODEL TYPE	A - WIDTH	B/C - DEPTH	D - HEIGHT	WEIGHT
400 Curved	14" * (356mm)	32.6" (830mm)	59.8" (1520mm)	291lb (132kg)
400 Square		33.6" (855mm)		300lb (136kg)
600 Curved	21.8" (556mm)	32.6" (830mm)	59.8" (1520mm)	320lb (145kg)
600 Square		33.6" (855mm)		326lb (148kg)
600 Square Hi-Line		73.4" (1865mm)	469.5lb (213kg)	
1000 Curved	38.3" (975mm)	32.6" (830mm)	59.8" (1520mm)	507lb (230kg)
1000 Square		33.6" (855mm)		522.5lb (237kg)
1000 Square Hi-Line		73.4" (1865mm)	650.3lb (295kg)	

*Unit width 14"/356mm, overall width 17.7"/450mm to accommodate side wing stabilising brackets fixed to castors.

Overall Dimensions - 4 Tier Curved/Square

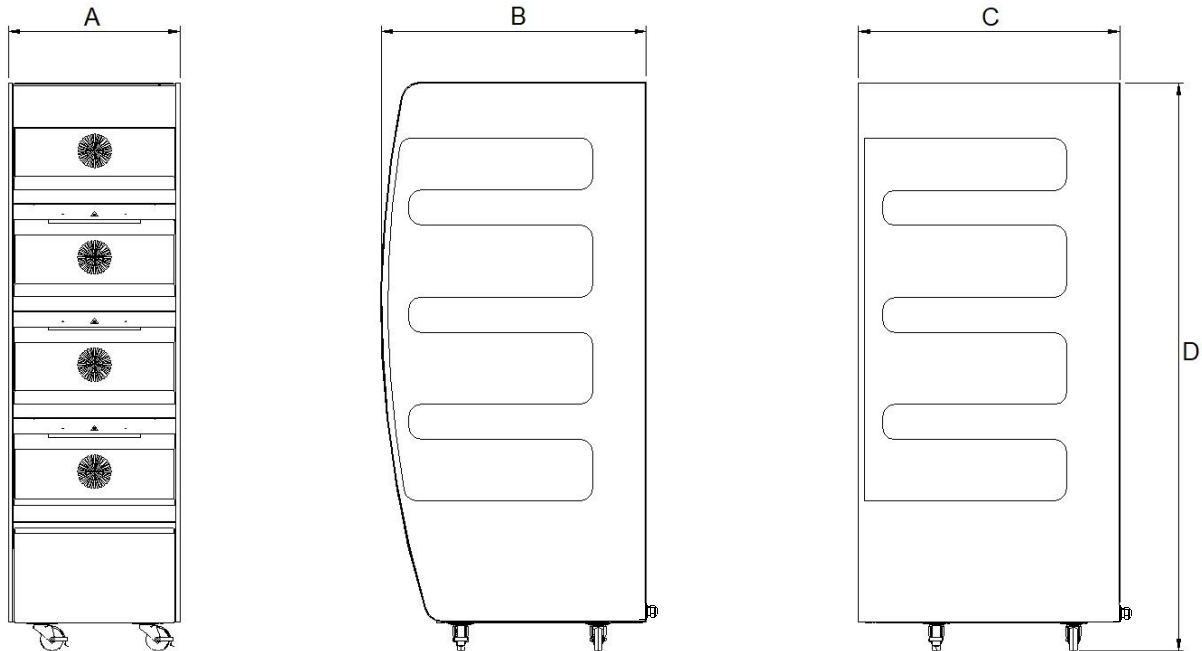

MODEL TYPE	A - WIDTH	B/C - DEPTH	D - HEIGHT	WEIGHT
400 Curved	14" * (356mm)	34" (865mm)	73.4" (1865mm)	410lb (186kg)
400 Square		33.6" (855mm)		416.6lb (189kg)
600 Curved	21.8" (556mm)	34" (865mm)	73.4" (1865mm)	462.9lb (210kg)
600 Square		33.6" (855mm)		469.5lb (213kg)
1000 Curved	38.3" (975mm)	34" (865mm)	73.4" (1865mm)	643.7lb (292kg)
1000 Square		33.6" (855mm)		650.3lb (295kg)

*Unit width 14"/356mm, overall width 17.7"/450mm to accommodate side wing stabilising brackets fixed to castors.

Overall Dimensions - 5 Tier Curved/Square

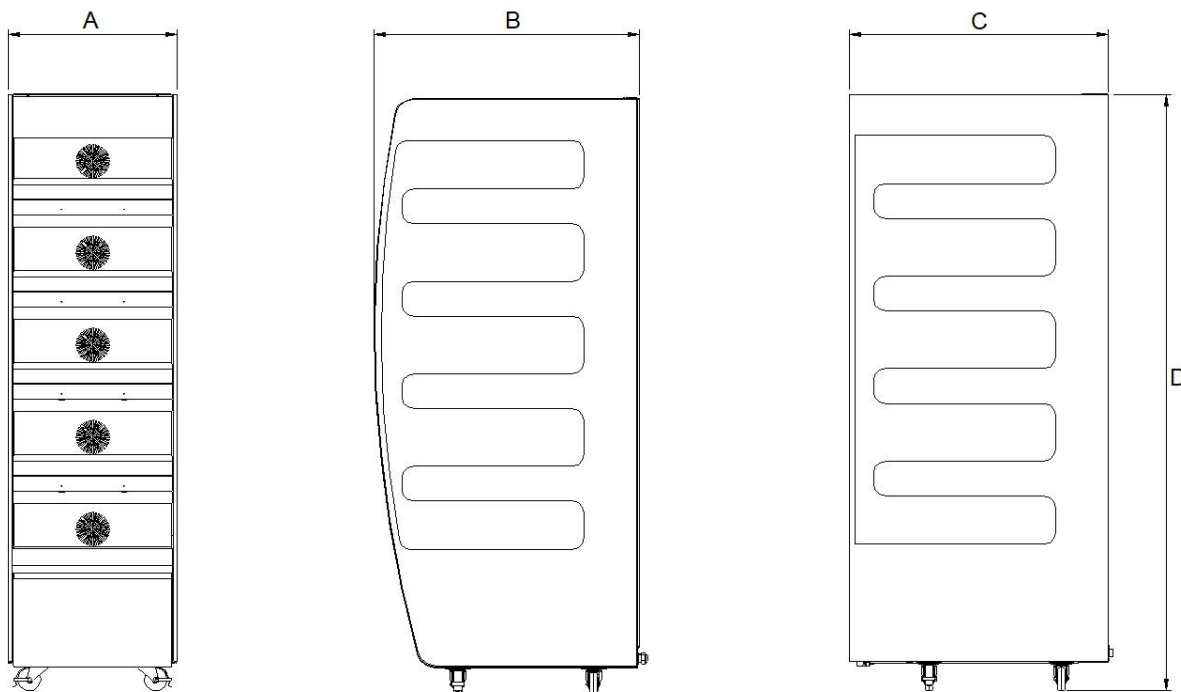

MODEL TYPE	A - WIDTH	B/C - DEPTH	D - HEIGHT	WEIGHT
600 Curved	21.8" (556mm)	34.3" (873mm)	77.5" (1970mm)	485lb (220kg)
600 Square		33.6" (855mm)		491.5lb (223kg)
1000 Curved	38.3" (975mm)	34.3" (873mm)	77.5" (1970mm)	650.5lb (295kg)
1000 Square		33.6" (855mm)		656.9lb (298kg)

Installation

**WARNING**

Installation of these units should be carried out by appropriately qualified and skilled personnel. Failure to do so may invalidate the warranty.

The equipment will be delivered to site boxed on a pallet.

Remove all packaging materials from the unit and dispose of correctly, in accordance with local regulations.

Care must be taken when removing packaging so not to damage or scratch the painted, glass or stainless-steel surfaces.

Remove all temporary tape.

Prior to the first use, clean with a proprietary food-safe cleaning solution, following the instructions set out in the cleaning and maintenance section of this manual. Ensure that an excessive amount of water is NOT used. Do NOT use aggressive detergents.

If there are any signs of damage, contact Flexeserve Customer Support immediately. Failure to report faults, defects or missing items upon delivery may incur charges.

Ensure that safe manual handling practices are employed at all times. Flexeserve Zone should be placed into position using the correct procedures, in line with local and regional safety policies.

The following considerations must be given to the site of installation:

- Avoid placing sources of heat near the appliance.
- Do NOT install the appliance near other equipment that generates high temperatures in order to avoid damage.
- The equipment should be sited so that it is not affected by draughts from doors or air conditioning systems. Temperature fluctuations are likely to occur if the equipment is not sited appropriately. This will have an adverse effect on product temperatures and may increase running costs.
- Ensure that the floor supports the weight of the unit at full capacity.
- Ensure that the unit is installed on a flat, even surface.
- A gap of at least 2 inches (50mm) should be left between the back of the equipment and any wall/solid surface.

The supporting or surrounding surfaces for the appliance must be:

- Non-combustible;
- Level, flat and even;
- Able to support the appliance's weight at full load, without undergoing deformation or structural failure;
- Immovable.

Positioning



WARNING

Installation of these units should be carried out by appropriately qualified and skilled personnel. Failure to do so may result in unsafe operation or personal injury.



WARNING

Adequate provision should be made for lifting and positioning the unit to avoid risk of damage or injury. Sufficient personnel should be available to handle each unit without contravening company or site health and safety policies.

It is recommended that a minimum of two persons are required for placing the equipment into position.

The equipment must be kept in the vertical orientation at all times.

A gap of at least 2 inches (50mm) should be left between the back of the equipment and any wall/solid surface.

Once the unit is placed in the desired location, it should be prevented from being moved.

The Flexeserve Zone floor standing models have castor brakes fitted that should be applied. The castor brakes are located to the front elevation of the unit, as shown in the illustration below.

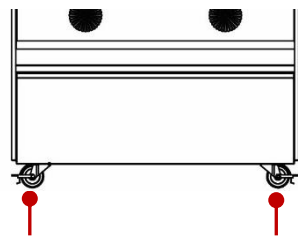
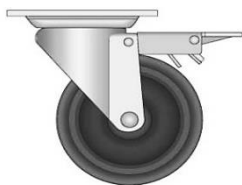

Front counter elevation showing front brake castors



Moving

Before moving the unit, isolate and disconnect the power cord from the wall socket. Stow the electrical power cord so that it does not become damaged during repositioning.

The units are not suited to pass over ledges or obstacles. Make sure that the wheels can move freely and never come into contact with the power cord (see figure below).

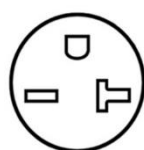

Wall socket

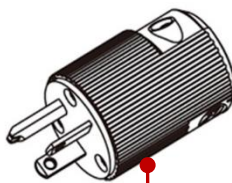

Plug



Electrical Connection



WARNING

Connection must only be carried out by suitably trained, qualified and skilled engineers, in accordance with all regional and local electrical codes.

The appliances are electrically rated for a 208V, 60Hz electrical supply.

Flexeserve Zone products are provided with a dedicated power cord and appropriate NEMA Style 6 power coupler rated for the equipment.

The equipment must be connected to a branch circuit protected grounded supply in accordance with local electrical codes.

Each unit must have its own dedicated power supply.

NOTE For electrical ratings of the unit, refer to the electrical rating sticker located within the front valance on the side of the control box. An example is shown below.

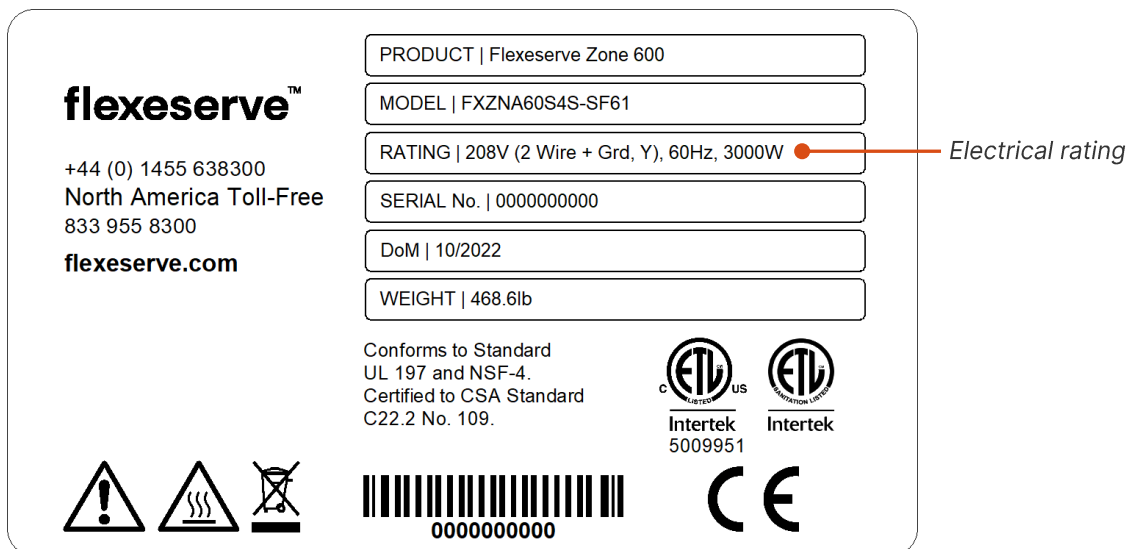

It is highly recommended to provide the equipment with an accessible means of isolation external to the equipment, i.e. a wall isolator switch.

Electrical Ratings

All models are rated 208V (2 wire + Grd, Y).

TOTAL POWER			
MODEL	3 TIER UNIT	4 TIER UNIT	5 TIER UNIT
400	2300 W	3000 W	2800 W
600	2300 W	3000 W	2800 W
1000	4500 W	6000 W	5000 W



WARNING

For all types of installation, ensure that the power cord is in a safe position. Under no circumstances should any electrical cables or power points be installed directly in contact with any part of the unit or pose a risk to safety.

If the mains power lead becomes damaged, isolate the equipment and remove from service immediately until a replacement is fitted by a suitably trained, qualified and skilled engineer, in accordance with all regional and local electrical codes.

Equipment Configuration



CAUTION

Each zone (shelf) must have the polycarbonate risers fitted to ensure safe and correct operation.



CAUTION

The unit will not operate correctly without the polycarbonate risers in the correct position.

Slide signage into the ticket strip. Close the valance panel when not in use.

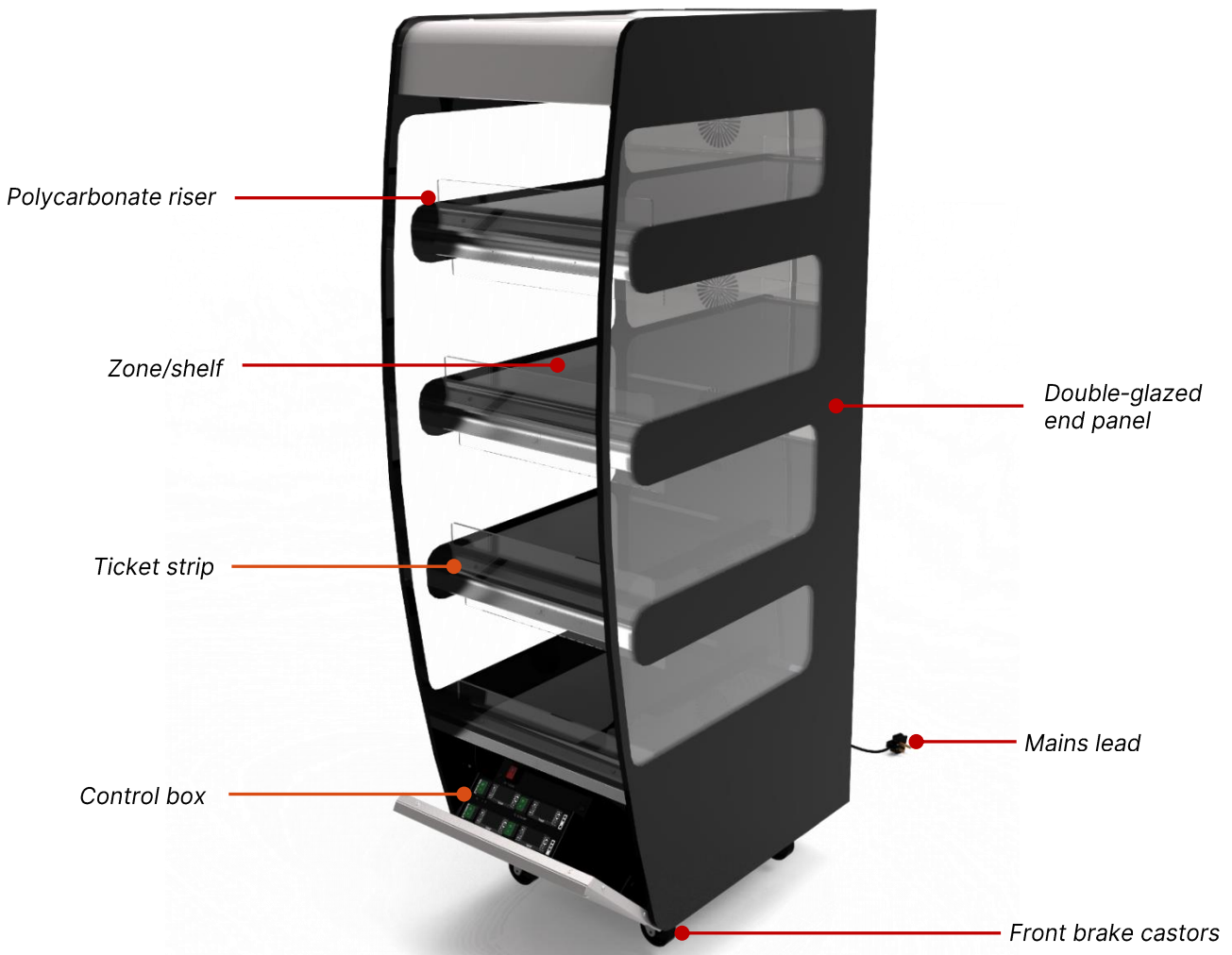

Power ON/OFF

Each Flexeserve Zone is supplied with an isolator or power switch to turn the unit on or of. This is located behind the front valance panel of Flexeserve Zone.

Set the mains isolator/power switch to the 'I' position to apply power to the unit and set to the 'O' position to power off.

3, 4 and 5 Tier - Models 400/600 Control Panel

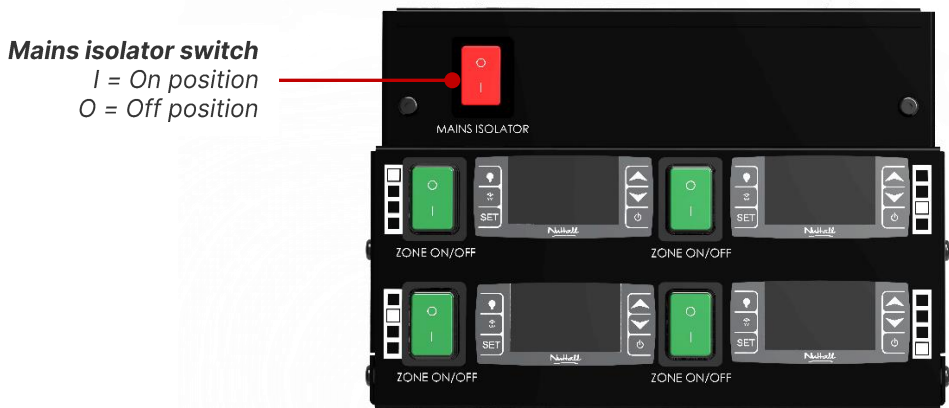

NOTE Illustration above represents a 4 Tier, model 400 or 600 control panel.

3, 4 and 5 Tier - Model 1000 Control Panel

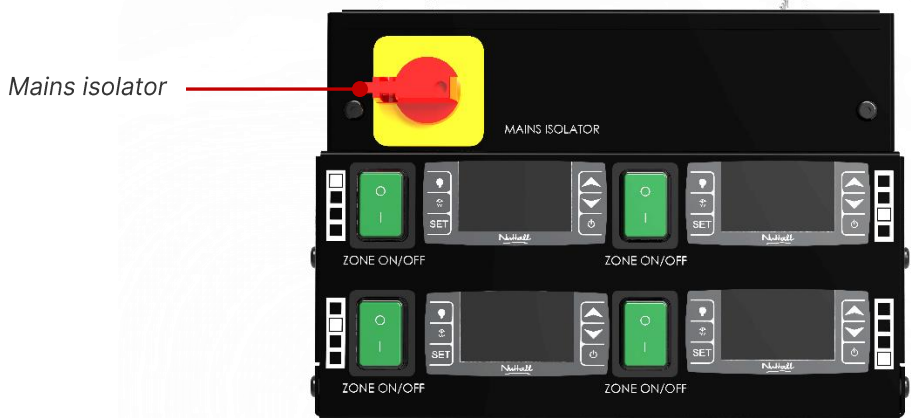

NOTE Illustration above represents a 4 Tier, model 1000 control panel.



WARNING

In an emergency, switch off the unit and isolate fully from the mains supply. Ensure that you take time to familiarise yourself with this location.

Switching On

Individual Zones - Heating



WARNING

In an emergency, switch off the unit and isolate fully from the mains supply. Ensure that you take time to familiarise yourself with this location.



CAUTION

The surface of the zones will become hot, reaching temperatures above 158°F (70°C).

Each of the model variants are supplied with one set of controls for each zone. The controls are located behind the valance panel at the base of the equipment.

Ensure that the unit is empty and clean prior to switching on. Check that the unit is connected to a power socket.

Before switching the unit on, it is the operator's responsibility to visually inspect the unit to ensure that there is no damage that may compromise safety.

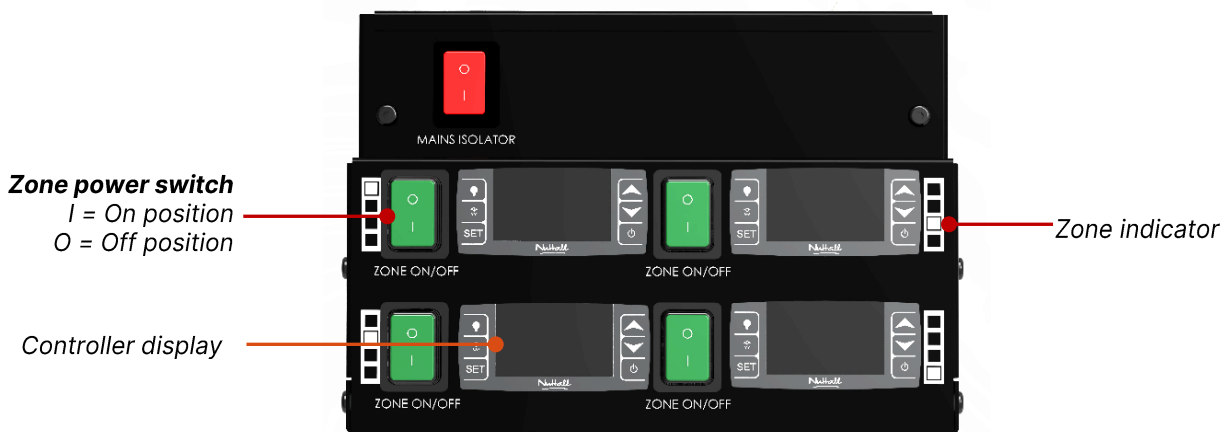

Set the zone power switch to the 'ON' position and the controller will illuminate. The display will show the current temperature. The zone will begin to heat and reach the established temperature set-point automatically, generally 185°F (85°C).

Where multiple zones are required, select and set the appropriate zone power switches to the 'ON' position separately.

The zones should be left empty without interference and may take up to 60 minutes to reach operating temperature. No products should enter the display area until it has reached the correct operating temperature.



WARNING

Do NOT place unpacked food products directly on to the hot shelves.

Individual Zones - Ambient/Lights Only



WARNING

In an emergency, switch off the unit and electrically isolate fully from the mains supply. Ensure that you take time to familiarise yourself with this location.



CAUTION

When switching from heating mode to ambient mode, the surface of the zones will remain hot for a period of time. Ensure that the unit has sufficiently cooled before placing ambient products into the zone (shelf).

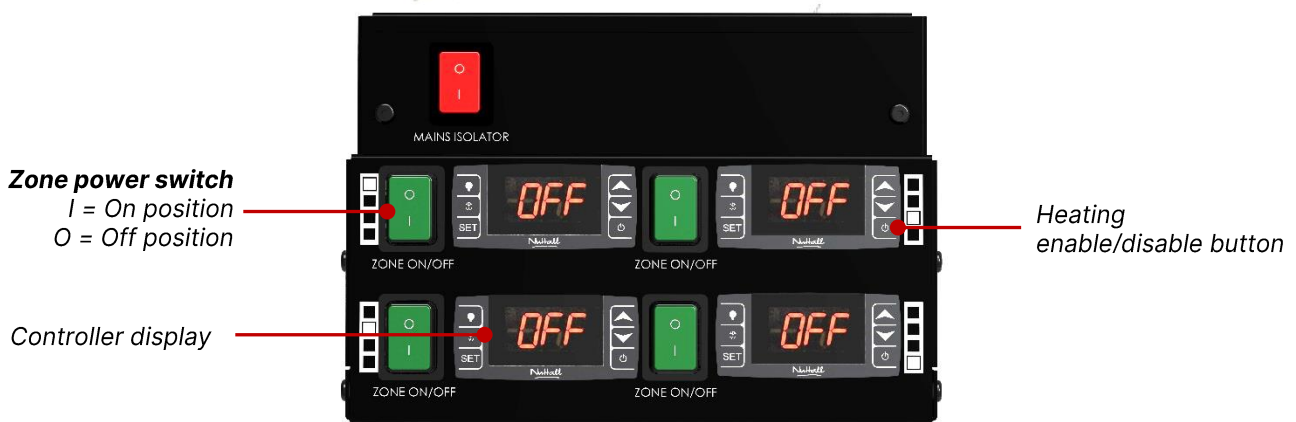

Switch on the zone power switch and the controller will illuminate. The display will show the current temperature.

To select the ambient mode

Press the heating enable/disable button and the display will read 'OFF'. Visually, you will see that the fan has stopped rotating and there is no air circulating around the zone. The zone is now in ambient mode.

Where multiple ambient zones are required, select and press the appropriate heating enable/disable button separately.

No products should enter the display area until the zone has cooled adequately to the required ambient temperature.

To reactivate the heating mode

Press the heating enable/disable button and the display will read the current operating temperature. Visually, you will see that the fan has started rotating and air is now circulating around the zone. The zone is now in heating mode.

No products should enter the display area until the zone has heated to the required temperature.

Switching Off

Individual Zones



WARNING

When switched off or disconnected from the power source, the surface of the zones (shelves) may still be hot, and may take up to two hours to cool down.



CAUTION

Cleaning and maintenance should only be carried out when each of the zones (shelves) have sufficiently cooled and with the mains supply electrically isolated.

To switch off the respective zone, set the zone power switch to 'O' position.

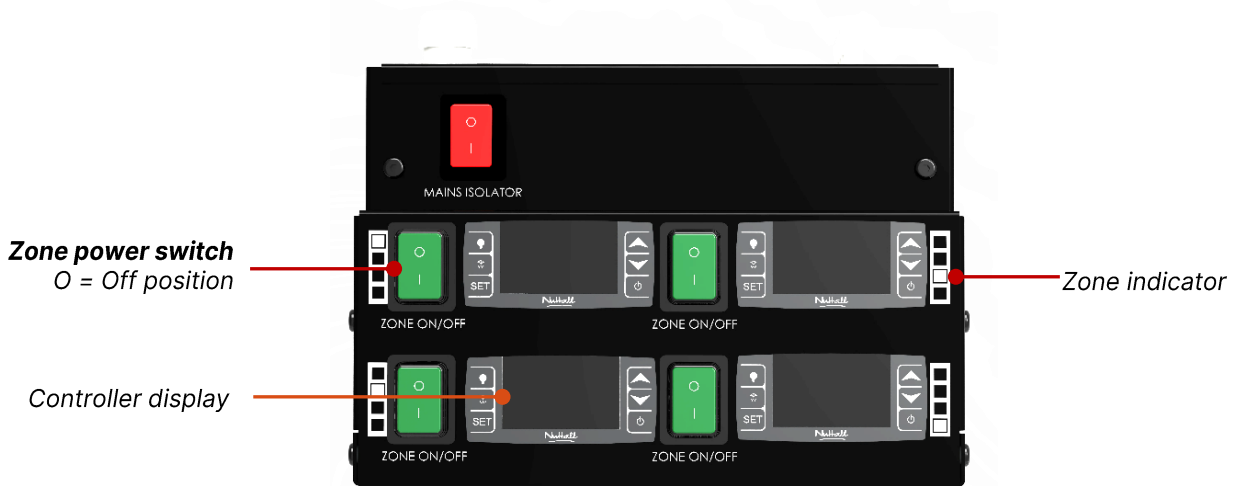

When an individual zone is turned off, the controller display and zone power switch will go blank, and the zone will be switched off.

To fully isolate the unit, disconnect the incoming mains supply by disconnecting the power cord from the supply.

Operation

Adjusting Temperatures



WARNING

Only if the operator has been trained and is skilled in the operation of the equipment covered in this guide should this information be followed.

Do NOT attempt to cook products on the shelves of the equipment.

Do NOT place cooking vessels on the shelves of the equipment.

Do NOT place anything heavier than 44lbs (20kg) on to the display surface.

The equipment will only maintain the temperature of products that have initially been cooked, prior to display. Ensure that food is transferred to the display area immediately after cooking in appropriate containers or packaging.

Ensure that temperatures of the displayed products are checked and recorded on a regular basis, in accordance with local regulations.

The temperature of each zone (shelf) is displayed by the appropriate zone controller and is for indication of operating temperature only. Do NOT use this as a reference to core temperature of foods on display; regular temperature probing of the product is to be performed.

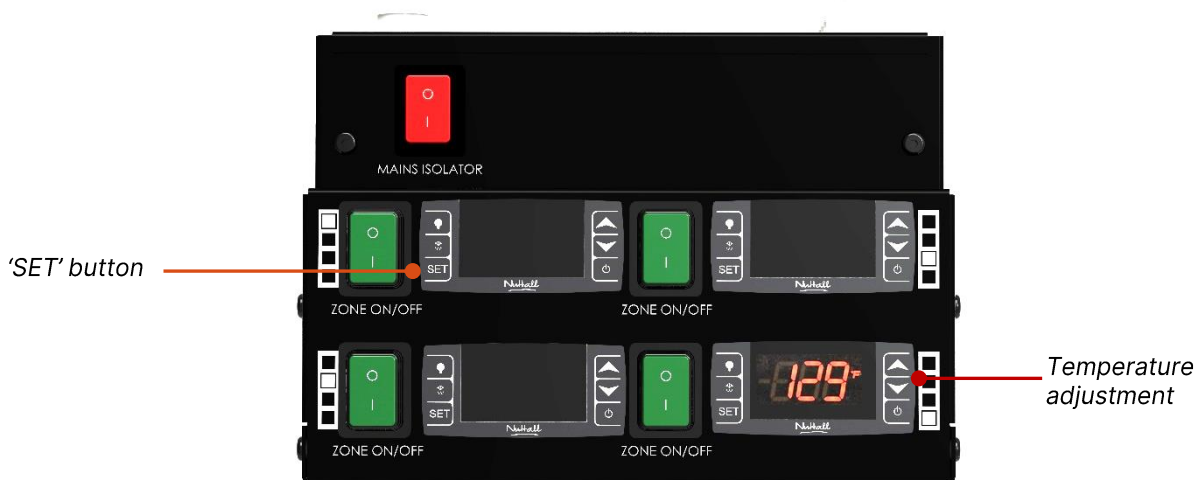

The minimum and maximum set-point values have been pre-set in the factory to prevent the equipment holding temperatures from being adjusted beyond legal and safety limits. These can only be adjusted by a Flexeserve appointed engineer.

To view the set temperature of each zone, press the 'SET' button for half a second, and then release.

To change the temperature of an individual zone, press and hold the 'SET' button until '°F' flashes on the display. Press the arrow buttons to increase (▲) or decrease (▼) the temperature. Press the 'SET' button again to input the new set point. After the temperature has been set, the display will revert back to the operating temperature, which will rise or fall as it reaches the set temperature.

Flexeserve Zone is manufactured to comply with health and safety regulations, and has been tested and certified to NSF standards. You must operate the equipment properly using only calibrated temperature probes to ensure food is thoroughly cooked to the safe standards according to local regulations.

Display and Merchandising

Different products require varying display times according to their core temperature. These must be considered to ensure the best quality and safe temperature for consumption is achieved. The Alan Nuttall Partnership Ltd does not accept responsibility for variances or losses of quality that occur due to product differences.

All items placed in Flexeserve Zone should be in the correct packaging/containers, in line with in-store procedures and best practice. Remove products in damaged packaging from the equipment and clean as soon as possible.

Do not obstruct the fan(s) at the rear of each zone as this can cause the built-in safety shut-off to activate and stop the equipment from working.

Product Probing



INFORMATION

Legal requirements dictate all products displayed for an extended period within any heated display area should be periodically probed throughout trading to ensure the core temperature of the product is above the legal holding temperature of the local authority. Refer to in-house operations manual for product probing instructions.

It is beneficial to enter the product into the holding unit as hot as possible for that particular food product to maximise shelf-life at the safe temperature.

The equipment is not designed to increase product temperature; the products gradually fall and regulate in temperature throughout the display period to ensure good product quality. It is critical that the entry core temperature is as high as possible so the maximum display time is achieved. The product will fall in temperature during its display time regardless of the entry temperature; therefore, a low entry temperature will reduce display time.

At the end of recommended display times, any unsold products should be removed, reduced and disposed of, in accordance with company and food safety standards.

The Alan Nuttall Partnership Ltd does not take responsibility for variances or loss of quality that may occur due to product differences.

Recording Product Temperatures

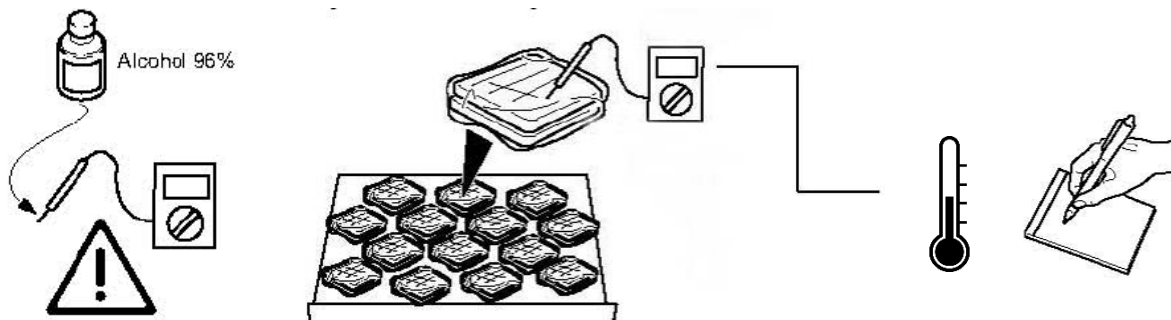

The core temperature of the products should be periodically probed and recorded according to local authority guidelines.

Daily Cleaning



CAUTION

Isolate the equipment fully before any cleaning is undertaken.



CAUTION

Ensure that the equipment has completely cooled before any cleaning is undertaken.

Only suitably trained personnel should carry out cleaning procedures.

Ensure that the power has been isolated.

Ensure that all display surfaces are allowed to cool to room temperature. Clean the surface of the shelf with a damp cloth soaked in mild detergent.

Ensure that water is not allowed to pool or sit on the glass surface. Sanitise and dry, as required.



WARNING

If the surface glass is cracked or damaged, discontinue use.

Do NOT use excessive amounts of water.

Do NOT clean the equipment with high-pressure cleaners, jets of hot water or high-pressure steam. All traces of food debris should be removed completely.

Do NOT use abrasive cleaning products as these could damage the finish of the equipment. It is recommended that non-abrasive cleaning products are used. Do NOT use glass cleaning products.

The polycarbonate risers and ticket strips can be removed and cleaned by lifting.

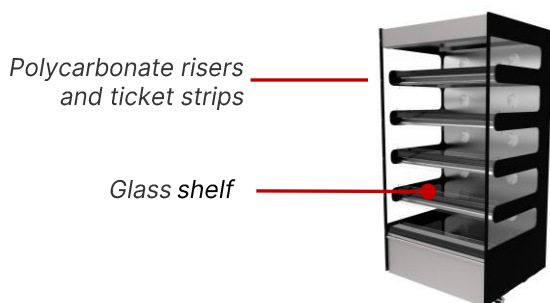

Once the front polycarbonate risers are removed, crumbs and debris can be swept forwards and out of each zone. Glass shelves, inner side wells, lamp diffuser glass and external surfaces can be cleaned using non-abrasive cleaning products.



WARNING

Do NOT use aggressive detergents. Ensure that all risers are refitted before use of the unit.

The Alan Nuttall Partnership Ltd cannot take responsibility for any malfunction or damage if these cleaning procedures are not adhered to.

Troubleshooting



CAUTION

Never attempt to open electrical connection enclosures. Only approved, trained and competent engineers should access the base of the unit and electrical areas.



WARNING

The information provided is for guidance only. The Alan Nuttall Partnership Ltd cannot be held responsible for any accidents or injuries caused by instructions being carried out incorrectly, or by the way the information is depicted.

Fault	Potential Cause	Solution
Unit is not operating.	No power.	Check that the switches on Flexeserve Zone are switched on.
		Check that the unit is plugged into a working socket.
		After the above, contact Customer Support.
Shelf is not operating at temperature.	Parts are missing.	Ensure that risers and air deflectors are in place.
	Store conditions.	Refer to the 'Specifications' page of this Operation Manual for the ambient conditions required.
	Set point.	Ensure that the unit is set to the correct temperature.
	Over-temperature thermostat has operated causing a blank display.	Contact Customer Support.
	Fan is spinning but cold air is blowing.	Contact Customer Support.
Display shows 'P1', not the temperature.	Probe fault on the zone.	Check to see if any plugs have disconnected from the control box.
		Contact Customer Support.
Lights are not working.	Light unit has failed.	Contact Customer Support.

This information is provided for guidance only and is not exhaustive. Always use best practice fault-finding techniques to establish and eliminate faults.

Some faults must only be investigated by a trained and qualified Engineer. For assistance, contact **Customer Support.**

Spare Parts and Service

For all spares and service requirements, please contact **Customer Support**.

Your product can be identified by the electrical rating sticker located inside the front valance panel on the side of the control box.

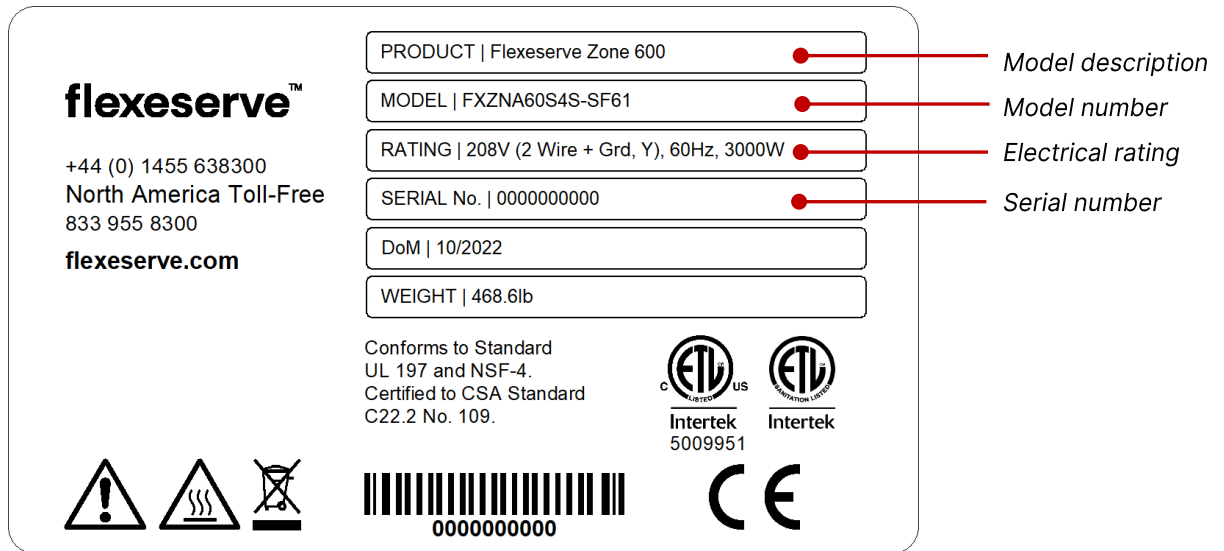

To help us process your service call efficiently, we will require the following information:

1. Serial number;
2. Description of fault;
3. Site telephone number;
4. Site address.

Disposal of this Equipment



WASTE OF ELECTRICAL AND ELECTRONIC EQUIPMENT

Penalties may be applicable for incorrect disposal of waste, in accordance with national legislation.

This product should not be mixed with general household waste. For proper treatment, recovery and recycling, please return this product to Flexeserve or take this product to a designated collection point where it will be accepted free of charge. Contact details can be found on the following page.

Disposing of this product correctly will help save valuable resources and prevent any potential negative effects on human health and the environment, which could otherwise arise from inappropriate waste handling.

Contact Us

At Flexeserve we continue to make improvements. Feedback regarding any concerns relating to this unit is always welcome.



**Customer Support
& Enquiries**

Call Toll-Free 833 955 8300



**Customer Support
Enquiries**

customer.support@flexeserve.com
info@flexeserve.com



**Customer Support
& Enquiries**

FLEXESERVE
The Alan Nuttall Partnership Ltd - Orchard House, Dodwells Road,
Hinckley, Leicestershire, LE10 3BZ United Kingdom



Website

flexeserve.com