

# SERVER

• E S S E N T I A L S •

## Food Container Pumps Stainless Steel Pumps

SPECIFICATION SHEET



### FAST FACTS

Stainless steel food container pumps fit #10 cans and 1 gallon jars while dispensing 1 oz max portions that can be reduced by 1/8 oz increments.

### APPLICATIONS

- Serve flavored dessert syrups and condiments like ketchup, mayo and salad dressings straight from their original containers

### DETAILS

- Dispense portion-controlled condiments and toppings straight from the original container; models available fit #10 cans and 1 gal jars
- Precise portions control food costs and ensure flavor consistency
- 3 qt jar available for house-made sauces – jar opening matches #10 can
- Pump knobs can be colored or engraved for easy identification
- NSF listed, clean-in-placen certified or easily disassemble for cleaning



SP  
82000





CP-10  
83000



CP-G 110 mm  
83120











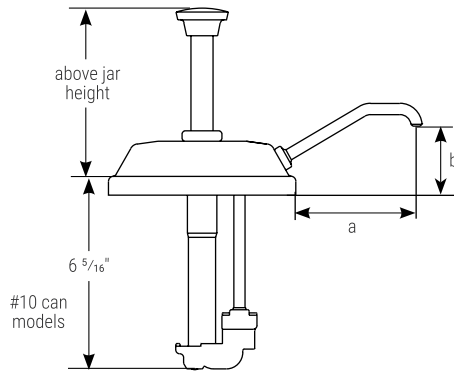





Purposefully made to last.

SEE TABLE FOR APPLICABLE TRAITS BY MODEL		
DISPENSES KEY		<b>THIN</b> fountain syrups • oils • hot sauce
		<b>THICK</b> ketchup • mustard • mayo • bbq
		<b>THICKER</b> tartar sauce • crafted sauces
APP KEY		<b>AMBIENT</b>
		<b>COLD</b>
		<b>HOT</b>

## STAINLESS STEEL FOOD CONTAINER PUMP MODELS: SP, CP-10 & CP-G

Server stainless steel food container pump models dispense directly from a manufacturer's food container. SP and CP-10 models dispense from #10 cans or Server's stainless steel jar 94009, (sold separately). For 1 gallon jars, use model CP-G with corresponding jar opening size. Pumps dispense 1 oz max portion; adjustable in 1/8 oz increments. NSF listed, clean-in-place certified. Two-year warranty.



order amt	dispenses	model/item	application	pump & lid fit	full portion	above jar (H)	dim a	dim b	weight
<input type="checkbox"/>		<a href="#">SP 82000</a>		#10 can or 94009 jar (jar not included)	1 oz	5 9/16"	4 1/8"	1 11/16"	2 lb
<input type="checkbox"/>	 	<a href="#">CP-10 83000</a>					4 1/16"	1 1/4"	
<input type="checkbox"/>	 	<a href="#">CP-G 89 83130</a>		gallon container, 89 mm threads			3 1/2"		
<input type="checkbox"/>	 	<a href="#">CP-G 110 83120</a>		gallon container, 110 mm threads	1 oz	4 3/8"	3 1/4"	2 1/16"	3 lb
<input type="checkbox"/>	 	<a href="#">CP-G 120 83110</a>		gallon container, 120 mm threads			3 1/16"		

## RELATED PRODUCTS

### 94009 JARS

Dispense homemade sauces, condiments and toppings or transfer pouched products for easy dispensing with the 3 qt jars.



### COLORED, ENGRAVED KNOBS

Interchangeable engraved and colored knobs help staff and patrons identify contents, coordinate with store themes or promote branded products. Specify color and text at time of order – exact shade may vary.



GET OUT ALL THE GOOD WITH FOOD CONTAINER PUMPS  
SERVER-PRODUCTS.COM | 800.558.8722 | 262.628.5600