

SlimLine™
DRY FOOD DISPENSER
MODEL: DFD

CAPACITY:
1.4 Liter
2 Liter

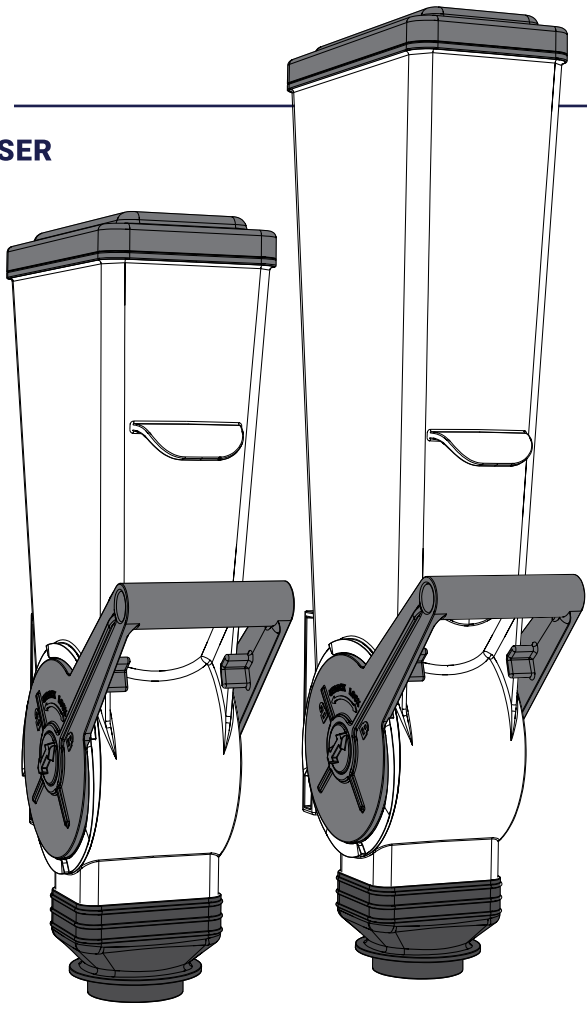

Thank You

for purchasing our SlimLine™ Dry Food Dispenser. This flavor station lets you dispense precise portions of candies, toppings and mix-in ingredients. Additional dispensers neatly mount side-by-side: (4) flavors every 13 inches.

ACCURATE, ADJUSTABLE PORTIONS IN LESS SPACE

QUICK START

YOU WILL NEED:
• Screwdriver
• (4) screws &
(4) anchor bolts (if needed)



PRACTICE SAFETY.

WASH ALL PARTS PROPERLY BEFORE USE. See page 5.

1 INSTALL WALL BRACKET

Select wall location or sturdy vertical surface for mounting.
Determine proper mounting hardware you will need to supply.
Secure bracket to wall stud(s), anchor bolts in wall, or sturdy vertical surface.

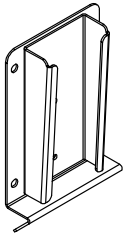

2 PLACE PORTION TRAYS

Color-coded trays indicate portion dispensed (by volume).
Slide all four trays of desired serving size into cylinder.

Curved tab on tray end should rest outside cylinder.

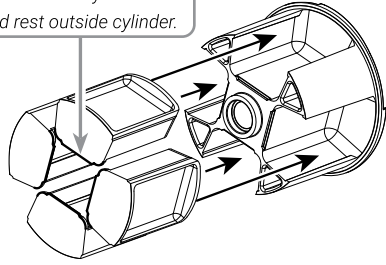

PORTION	COLOR
0.50 fl oz	White
0.75 fl oz	Blue
1.0 fl oz	Green
1.5 fl oz	Pink

DID YOU KNOW?

The cylinder may be used without any portion trays. This yields portions each 2 fl oz.

3 ATTACH FRICTION PAD

Insert four triangular tabs on friction pad into matching slots in cylinder.

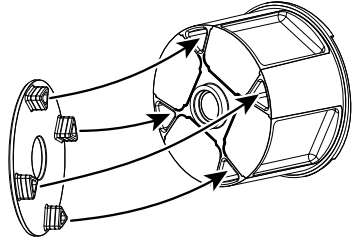

4 INSTALL CYLINDER

Slide cylinder, friction pad first, into the opening of dispenser body.

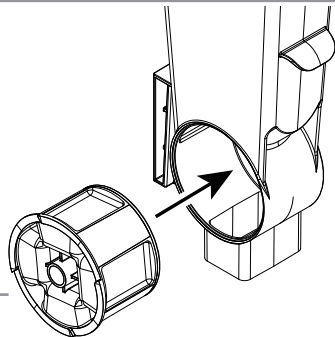

5 INSTALL HANDLE ONTO BODY & CYLINDER

Slide handle over both sides of body and cylinder.
Snap handle centers into holes on each side.

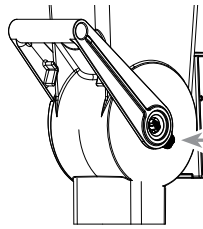
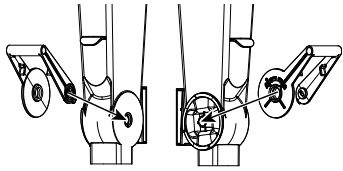

Use pull-tab on right side of handle to help position.

6 INSTALL PIVOT PIN

Slide pivot pin into center hole on left side of handle.

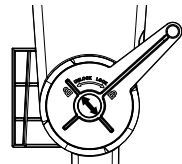
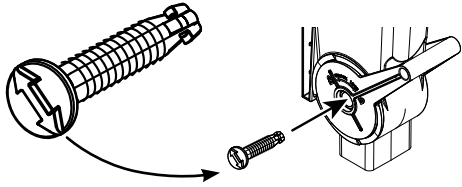

Align arrow on the pin with the unlock position. 

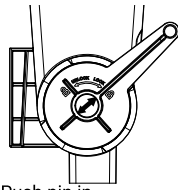

Push pin in. Rotate to the locked position. 

7 ADD ADAPTER CUP to the bottom opening of the unit.

8 FILL UNIT WITH INGREDIENT YOU WANT TO DISPENSE

9 PUT THE LID ON TOP OF THE UNIT

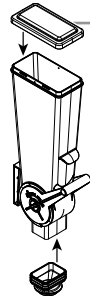

10 SWING HANDLE UPWARD

to load the tray.

SWING HANDLE DOWNWARD

to dispense the portion.

TIP: For cylinder to advance and serve a portion, the handle must travel its full range of motion up and down. Handle tabs must strike bottom.

READY! 

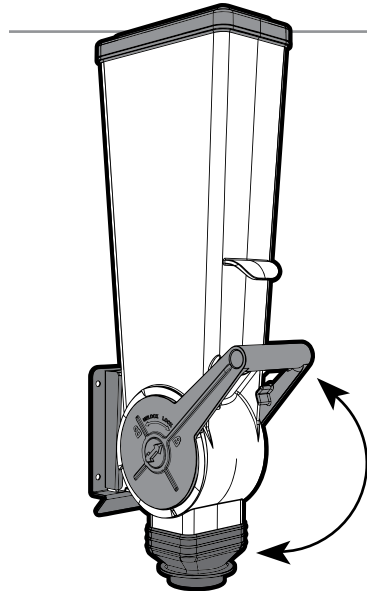

DISASSEMBLY

1 REMOVE LID

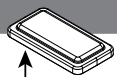

2 EMPTY INGREDIENTS FROM UNIT

3 REMOVE ADAPTER CUP

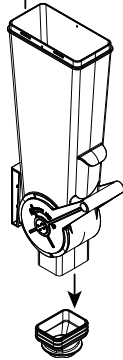

4 REMOVE PIVOT PIN

Rotate pin to the unlock position and take it out.

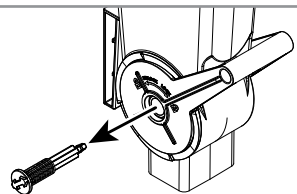

5 REMOVE HANDLE

Use the pull-tab on right side to assist.

Lift handle upward to the position just before it would click. This makes the handle easier to remove.

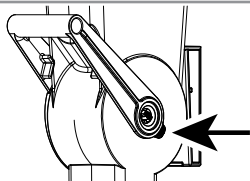

6 REMOVE CYLINDER

Slide the cylinder out of the unit.

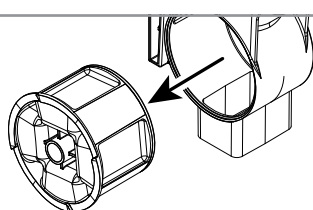

7 REMOVE FRICTION PAD

8 REMOVE PORTION TRAYS

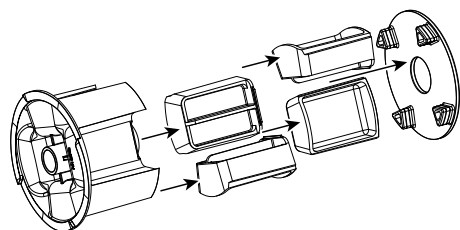

NEXT: CLEAN

SAFETY



According to food and safety regulations, most foods must be stored and/or served at certain temperatures or they could become hazardous. Check with local food and safety regulators for specific guidelines.

Be aware of the product you are serving and the temperature the product is required to maintain. Server Products, Inc. cannot be responsible for the serving of potentially hazardous product.



NSF International listed.



IMPORTANT

Clean, rinse, sanitize, and dry parts daily or regularly to comply with local sanitization requirements.

CAUTION

Keep fingers clear of all moving parts to prevent operator injury when dispensing product, during cleaning, assembly and disassembly.

CLEANING



1 CLEAN

After disassembling, clean all washable parts with soap and hot water.

2 RINSE

fully with clear water.

3 SANITIZE

all parts according to local sanitization requirements. All parts in contact with food must be sanitized.

4 AIR DRY

all parts fully.

YES!

Use dishwashing soap and hot water

- External surfaces may be wiped clean with a clean damp cloth.
- Glass and surface cleaners approved for use in food contact areas may be used.
- Do not use abrasive, caustic or ammonia based cleansers.
- Do not use metal scrapers or cleaning pads that could scratch surfaces.

TROUBLESHOOTING

UNIT DISPENSES LITTLE OR NO PRODUCT?

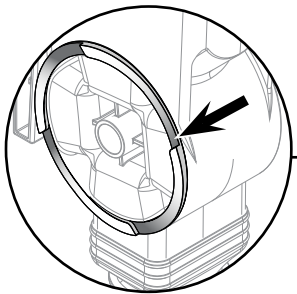

Make sure the **handle** is tight to the body, positioned above side notch.

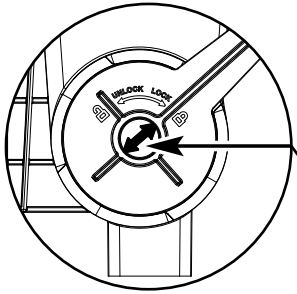

Make sure the **handle** is installed correctly with the pivot pin locked in place.

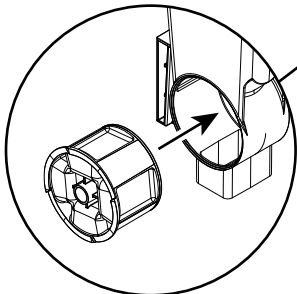

Make sure the **friction pad and cylinder** are properly installed.

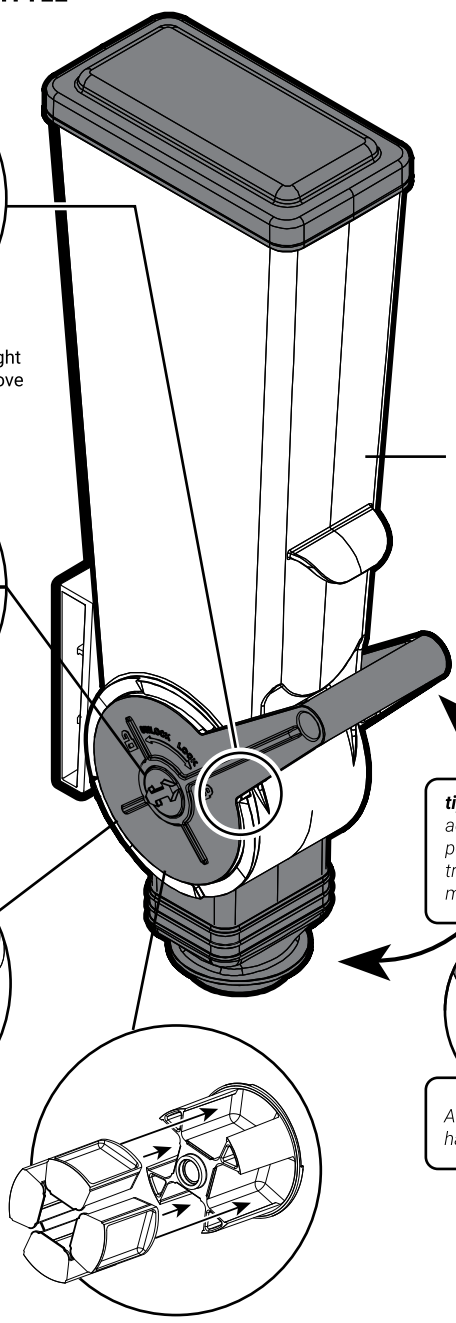

Make sure there is **product** remaining to dispense and that the product is free to move to the bottom.

tip: For cylinder to advance and serve a portion, the handle must travel its full range of motion up and down.

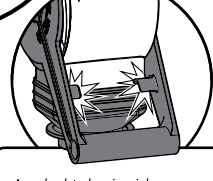

Angled tabs inside handle must tap bottom.

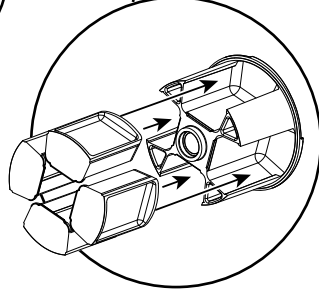

Make sure the **portion trays** are installed correctly. The curved tab on tray end should rest outside cylinder.

SERVER PRODUCTS LIMITED WARRANTY

2
YEAR
WARRANTY

This Server product is backed by a two-year limited warranty against defects in materials and workmanship. See Server-Products.com for details.

GENERAL SERVICE, REPAIR OR RETURNS

Before sending any item to Server Products for service, repair, or return, contact Server Products customer service to request a **Return Authorization Number**. Merchandise must be sent to Server Products with this number. Service is extremely prompt. Typically, units are repaired and ship out within 48 hours of receipt.

Merchandise being returned for credit must be in new and unused condition and not more than 90 days old and will be subject to a 20% (percent) restocking charge.

SLIMLINE™ DRY FOOD DISPENSER

MODEL: DFD

BRACKETS

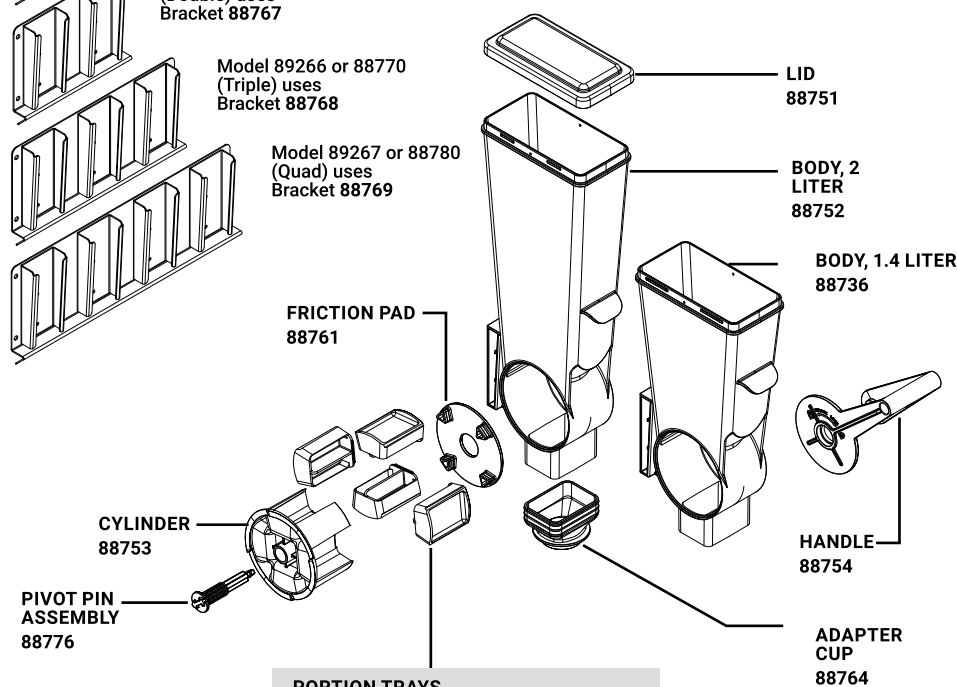
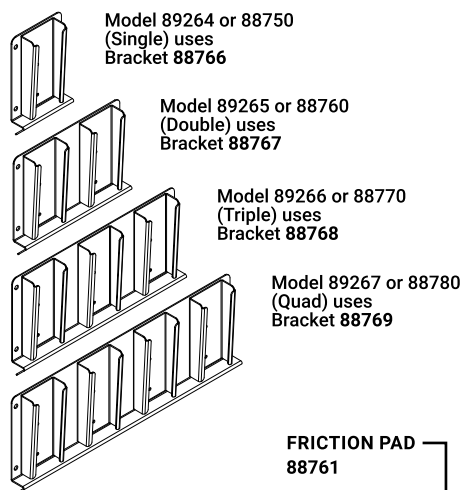

PORTION TRAYS		
COLOR	PORTION	4-PACK OF TRAYS
White	0.50 fl oz	88795
Blue	0.75 fl oz	88796
Green	1.0 fl oz	88799
Pink	1.5 fl oz	88797

NEED HELP?

Server Products Inc.
3601 Pleasant Hill Road
Richfield, WI 53076 USA

[Chat with us!](#)
spsales@server-products.com
262.628.5600 | 800.558.8722

Please be prepared with your **Model, P/N** and **Series** located on the lid or base of the unit.

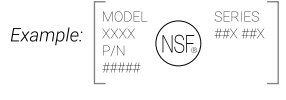

Manual #EM_01921_RevC 020822