



Model: _____ Item #: _____ Date: _____

Project: _____ Qty: _____ Approved By: _____

Drop-In Ice Bins / Mobile Ice Bins

Royal Series Underbar



Drop-In Ice Bin Standard Features

- Drop-in design can be quickly installed into tabletops, counter tops, or behind the bar
- Includes two piece 20 gauge stainless steel sliding cover
- Fully insulated ice bin minimizes ice melt
- 10" deep liner (15" deep liner on D2712DP)

Drop-In Ice Bin Specifications

Cold Plate (Ice Bin)	▪ Cast aluminum post mix plate with 7 or 10 circuits (depending on model). Plate is sealed into bottom. Each circuit is 5/16" OD stainless steel tubing. Two full with remainder to be half circuits. Bump and wedge fittings on ends.
	▪ Cold plate models include 1/2" x 6" PVC tailpiece (1/2" - 20 male threaded)
Plumbing	▪ Cold plate: 1/2" IPS drain connection ▪ No Cold Plate: 1" IPS drain connection
Interior	▪ 20 gauge stainless steel
Insulation	▪ Foamed-in-place polyurethane

(See page 2 for Drop-In Ice Bins model numbers and cut sheet)



Mobile Ice Bin Standard Features

- Ice bin built on durable cross-braced legs with casters for mobility
- 20 gauge stainless steel interior, sides, and front apron
- 12" deep ice bin
- 1" IPS drain with shut-off valve
- Foamed-in-place polyurethane insulation
- Optional sliding cover available (MB-SC)

Mobile Ice Bin

Model	Length (A)	Width	Ice Bin Depth	Weight (lbs.)
MB-1824	24"	18-1/2"	12"	65
MB-1830	30"	18-1/2"	12"	80
MB-1836	36"	18-1/2"	12"	95

WARNING: Plumbing connections should be made by qualified personnel who will observe all applicable plumbing, sanitary and safety codes.

California Prop 65 Warning:

This product can expose you to chemicals including lead and lead compounds, which are known to the State of California to cause cancer and birth defects or other reproductive harm. For more information go to www.P65Warnings.ca.gov.

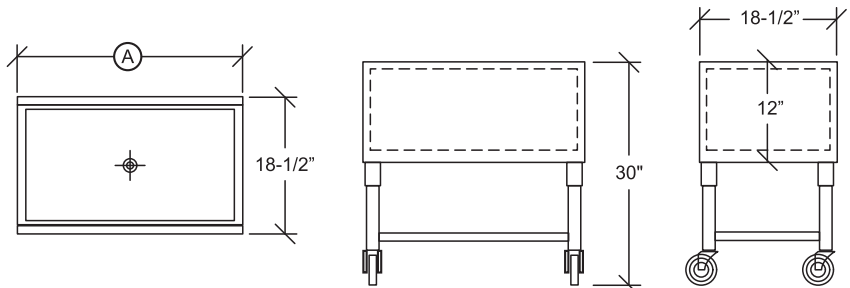



Model: _____ Item #: _____ Date: _____

Project: _____ Qty: _____ Approved By: _____

Drop-In Ice Bins / Mobile Ice Bins

Royal Series Underbar

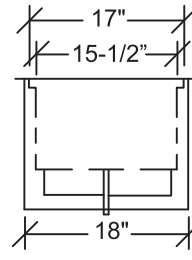
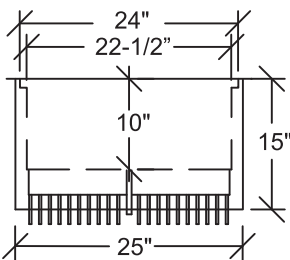
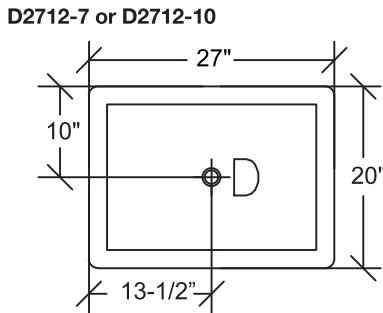
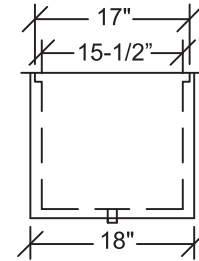
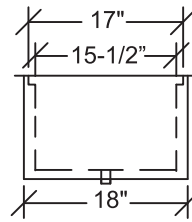
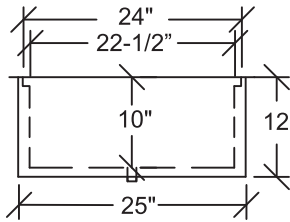
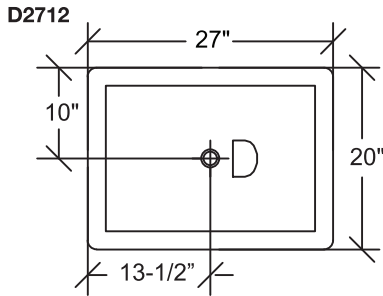
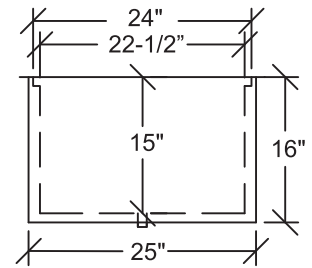
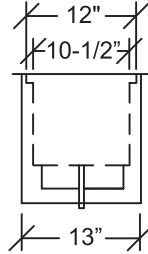
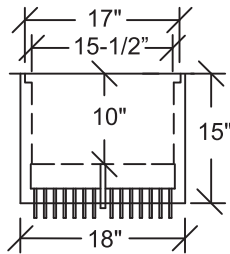
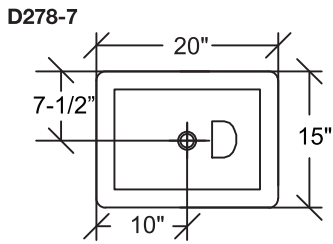
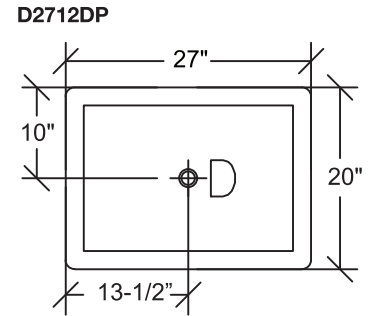
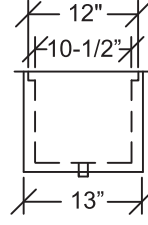
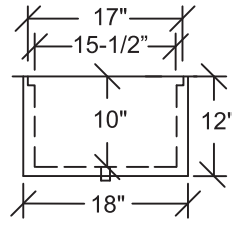
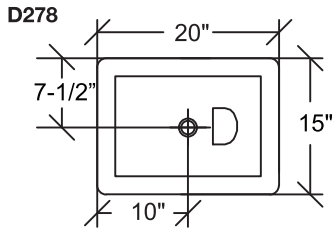

Drop-In Ice Bins

Model	Description	Length	Width	Overall Depth	Liner Depth	Cutout	Cold Plate Circuits	Ice Bin Capacity	Weight (lbs.)
D278	Medium Ice Bin	20"	15"	12"	10"	18-1/4" x 13-1/4"	N/A	50	35
D278-7	Medium Ice Bin with 7-Circuit Cold Plate	20"	15"	15"	10"	18-1/4" x 13-1/4"	7-Circuit	50	60
D2712	Large Ice Bin	27"	20"	12"	10"	25-1/4" x 18-1/4"	N/A	73	60
D2712-7	Large Ice Bin with 7-Circuit Cold Plate	27"	20"	15"	10"	25-1/4" x 18-1/4"	7-Circuit	73	95
D2712-10	Large Ice Bin with 10-Circuit Cold Plate	27"	20"	15"	10"	25-1/4" x 18-1/4"	10-Circuit	73	95
D2712DP	Large Ice Bin Deep Style (15" deep liner)	27"	20"	16"	15"	25-1/4" x 18-1/4"	N/A	95	65

Mechanical Requirements: 1" IPS drain connection without Cold Plate, 1/2" IPS drain connection with Cold Plate