



## VIDEO INSTRUCTIONS

Scan QR code with phone camera or copy link into internet browser.



<https://bit.ly/HowtoAssembleRossetoHandsFreeFaucet>

## PARTS

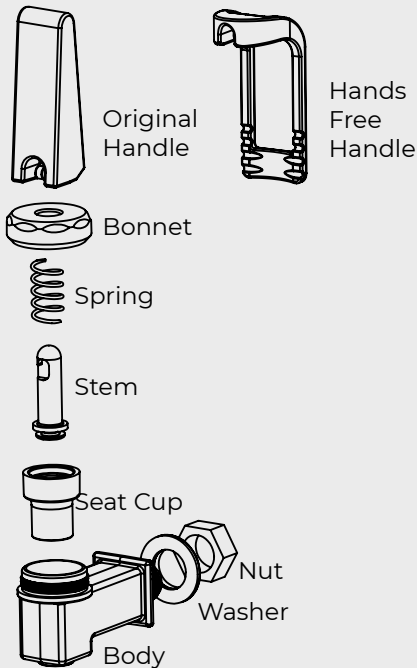

## ASSEMBLING YOUR HANDS FREE FAUCET HANDLE

1. If necessary, remove original handle from faucet body and separate parts.

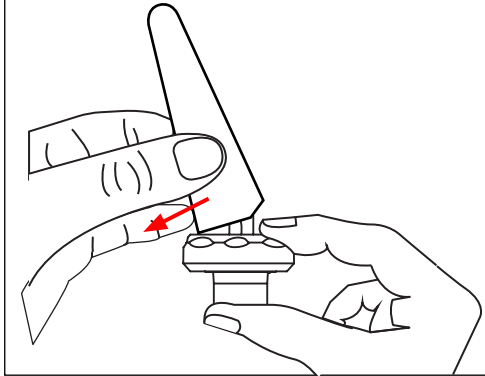

2. Place stem in seat cup. Push up on bottom of the seat cup until the stem pops into place. Place spring over stem. Place bonnet over stem.

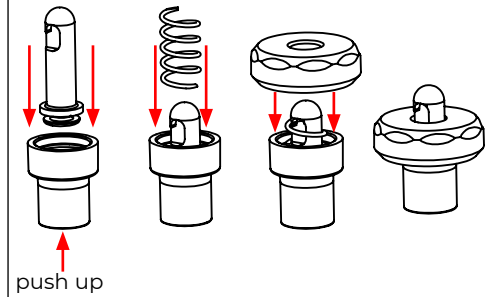

3. Hold assembly by placing thumb on bottom of seat cup and two fingers on either side of stem. Hook opening should be facing away from your hand.

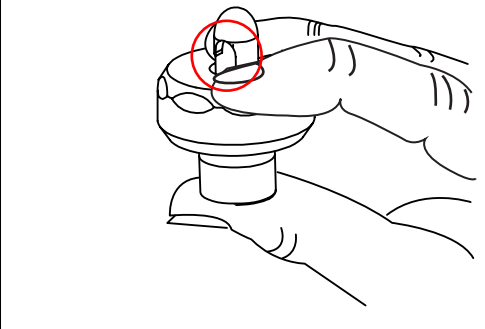

4. Hold handle in other hand. Make sure hook opening is facing front of handle as shown.

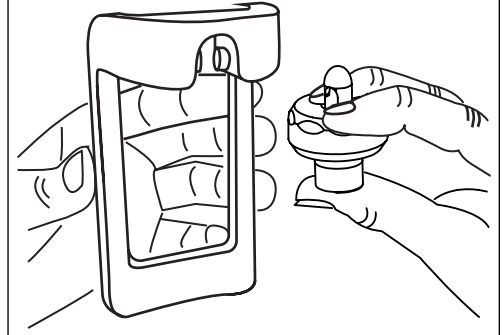

5. Align Hook opening with notches in the handle. Push up on seat cup so the stem rises.

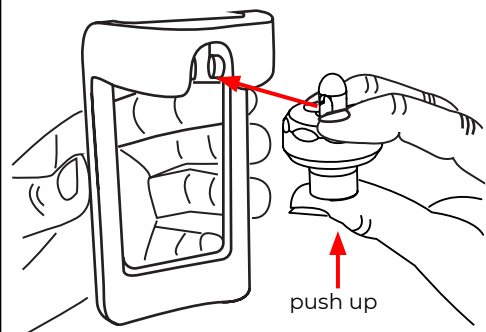

6. Push bonnet forward with thumb until hook opening latches onto the notches in the handle.

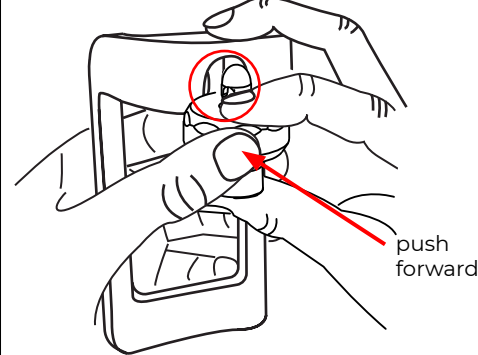

7. Hand tighten upper assembly to body by twisting bonnet clockwise.

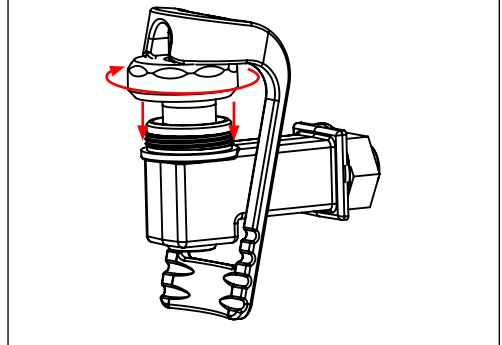

R2 07212020



## VIDEO INSTRUCTIONS

Scan QR code with phone camera or copy link into internet browser.



<https://bit.ly/HowtoAssembleRossetoHandsFreeFaucet>

## PARTS

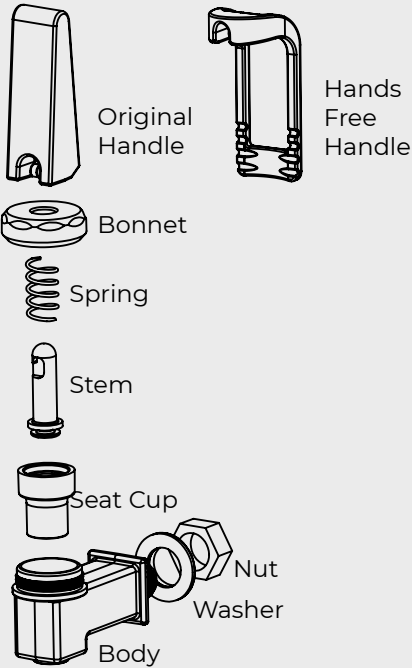

## DISASSEMBLING YOUR HANDS FREE FAUCET HANDLE

1. Rotate bonnet to the orientation as shown.

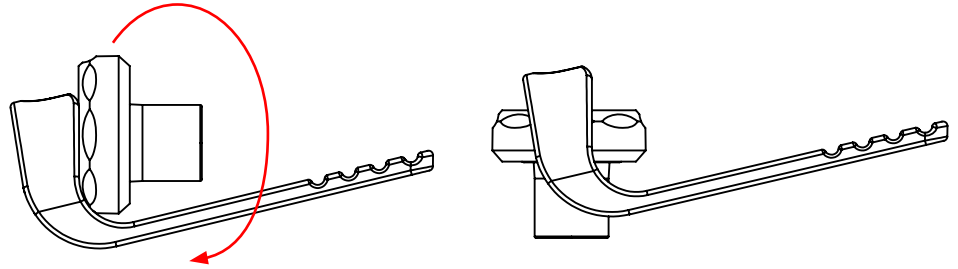

2. Place thumb on bottom of seat cup and two fingers on bonnet.

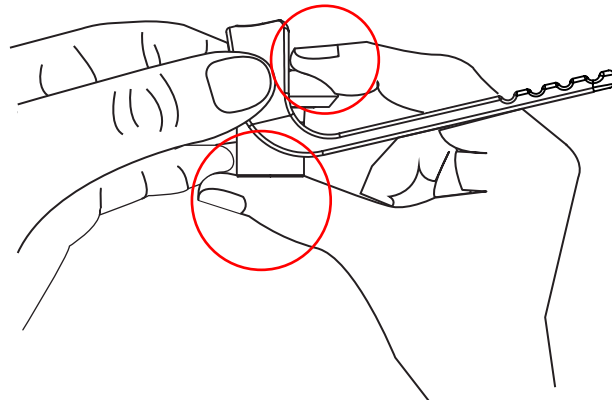

3. Pinch bonnet and seat cup together by pushing up with your thumb. Angle pieces out until the stem is unlatched from the notches. Be cautious to let go slowly as spring will release.

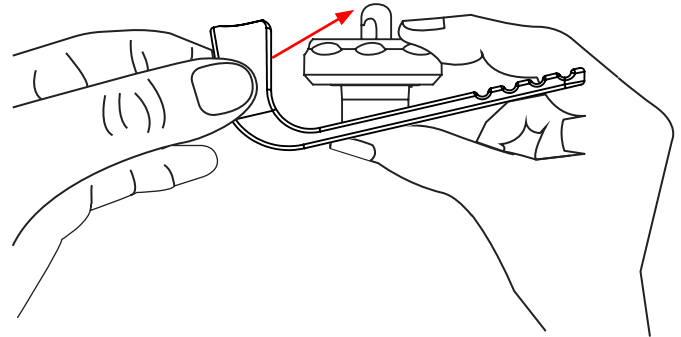
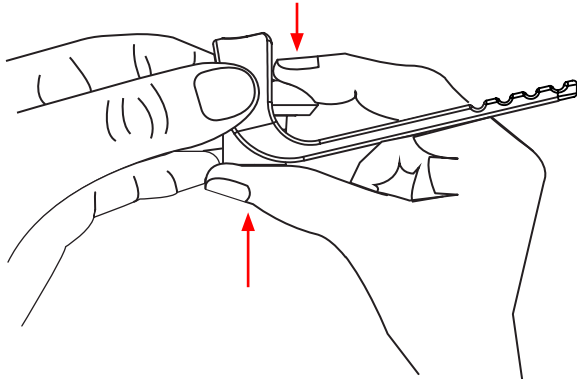

R2 07212020

