



# Camshelving® Elements XTRA Series

## Stationary Starter & Add-On Units 4 or 5 Vented Shelves

HEIGHT	DEPTHS	LENGTHS	
1	3	8	
64"	18"	24"	48"
	21"	30"	54"
	24"	36"	60"
		42"	72"

- Starter Units include:**  
2 factory assembled post kits, 8 or 10 shelf traverses, traverse dovetails and shelf plates.
- Add-On Units include:**  
1 factory assembled post kit, 8 or 10 shelf traverses, traverse dovetails and shelf plates.

All units ship complete in 1 box.



### Features & Benefits

- Designed to easily support the performance demands of a busy foodservice operation with medium to heavy storage needs.
- Use in walk-in coolers, freezers, dry storage, warewashing areas, loading docks or front of the house. Withstands storage temperatures -36° to 190°F (-38° to 88°C). Impervious to moisture, chemicals, salt, food acids and humidity.
- Posts and traverses are made of a revolutionary, extremely strong composite material with a smooth, easy to clean surface. Stronger than common wire shelving and lighter in weight than Camshelving Premium Series. Traverse dovetails are separate from the posts and attach easily to secure the shelf traverses.
- Smooth polypropylene shelf plates contain Camguard, an antimicrobial technology that inhibits the growth of mold, fungus and bacteria that may cause odors, stains and product degradation.
- Shelving Units interconnect in straight lines with shared posts. Uniquely engineered Post Connectors offer exceptional cross stabilization. Weight bearing is uncompromised and space is maximized. No add-on clips or "S" hooks required.
- Easily install heavy-duty Corner Connectors (front and back clasp design) to add shelves in corners or to install middle shelves between 2 units without any loss of weight bearing. Maximizes usable and easy to access storage space.
- Posts and traverses wipe clean. Traverses and shelf plates remove easily for cleaning.
- Shelf traverses can be removed and adjusted at 4" (10,2 cm) increments.
- Sturdy reinforced nylon foot adjusts easily to level units.
- Requires some assembly with minimal parts. Use a rubber mallet only.
- Lifetime warranty against rust and corrosion (posts, traverses and shelf plates).
- Available in 1 color – Speckled Gray (480).

Project \_\_\_\_\_

Item No. \_\_\_\_\_

Model No. \_\_\_\_\_

Quantity \_\_\_\_\_



Stationary Starter Unit



Stationary Starter and Add-On Unit

## WEIGHT BEARING CAPACITY

Weight must be evenly distributed across the entire shelf.

		UNIT LENGTH 24" – 60"	UNIT LENGTH 72"
<b>SINGLE UNIT</b>	Unit only	2400 lbs.	2400 lbs.
	Shelf only	800	600
	Unit with dunnage stand*	2800	2700
	Bottom shelf with dunnage stand*	1200	900
		UNIT LENGTH 24" – 60"	
<b>CORNER UNIT</b> With 2 Dunnage Stands required	Unit only	2400	—
	Shelf only	800	—
	Bottom shelf with dunnage stands*	1200	—
		UNIT LENGTH 24" – 60"	
<b>INTERMEDIATE SHELVES</b> Shelves Installed Between 2 Units	Unit only	2400	—
	Shelf only	800	—
	Bottom shelf with dunnage stands*	1200	—

\*Dunnage Stands add stability and increase weight bearing capacity on bottom shelf only. Add to any shelf length. Highly recommended for Starter Units 54" (1375 mm) and longer, all Corner Units, U-Shape Units and units specified for heavier loads.

### Approvals



Post Connectors, Corner Connectors, Floor Fastener, Wall Fastener, Identification Tags, Shelf Rails, Single Shelf Security Cage, Peg Board and Shelf Divider Bars are not NSF listed.



Information and specifications are subject to change without notice. Please confirm at time of order.

Telephone: (714) 848-1555 Toll Free: (800) 854-7631 Customer Service: (800) 833-3003

© Cambro Manufacturing Company Huntington Beach, California 92647

Printed in U.S.A. 09/23

www.cambro.com

# Camshelving® Elements XTRA Series

## Stationary Starter & Add-On Units 4 or 5 Vented Shelves

Project \_\_\_\_\_

Item No. \_\_\_\_\_

Model No. \_\_\_\_\_

Quantity \_\_\_\_\_

### V4

#### 4-Shelf Vented Units

Starter

Add-On

**64"**  
HEIGHT

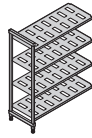

**18"**  
DEPTH

LENGTH	CODE
24"	EXU182464V4
30"	EXU183064V4
36"	EXU183664V4
42"	EXU184264V4
48"	EXU184864V4
54"	EXU185464V4
60"	EXU186064V4
72"	EXU187264V4

LENGTH	CODE
22"	EXA182464V4
28"	EXA183064V4
34"	EXA183664V4
40"	EXA184264V4
46"	EXA184864V4
52"	EXA185464V4
58"	EXA186064V4
70"	EXA187264V4

**21"**  
DEPTH

24"	EXU212464V4
30"	EXU213064V4
36"	EXU213664V4
42"	EXU214264V4
48"	EXU214864V4
54"	EXU215464V4
60"	EXU216064V4
72"	EXU217264V4

22"	EXA212464V4
28"	EXA213064V4
34"	EXA213664V4
40"	EXA214264V4
46"	EXA214864V4
52"	EXA215464V4
58"	EXA216064V4
70"	EXA217264V4

**24"**  
DEPTH

24"	EXU242464V4
30"	EXU243064V4
36"	EXU243664V4
42"	EXU244264V4
48"	EXU244864V4
54"	EXU245464V4
60"	EXU246064V4
72"	EXU247264V4

22"	EXA242464V4
28"	EXA243064V4
34"	EXA243664V4
40"	EXA244264V4
46"	EXA244864V4
52"	EXA245464V4
58"	EXA246064V4
70"	EXA247264V4

Color: Speckled Gray (480).

### V5

#### 5-Shelf Vented Units

Starter

Add-On

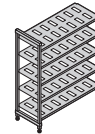
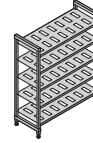

LENGTH	CODE
24"	EXU182464V5
30"	EXU183064V5
36"	EXU183664V5
42"	EXU184264V5
48"	EXU184864V5
54"	EXU185464V5
60"	EXU186064V5
72"	EXU187264V5

LENGTH	CODE
22"	EXA182464V5
28"	EXA183064V5
34"	EXA183664V5
40"	EXA184264V5
46"	EXA184864V5
52"	EXA185464V5
58"	EXA186064V5
70"	EXA187264V5

24"	EXU212464V5
30"	EXU213064V5
36"	EXU213664V5
42"	EXU214264V5
48"	EXU214864V5
54"	EXU215464V5
60"	EXU216064V5
72"	EXU217264V5

22"	EXA212464V5
28"	EXA213064V5
34"	EXA213664V5
40"	EXA214264V5
46"	EXA214864V5
52"	EXA215464V5
58"	EXA216064V5
70"	EXA217264V5

24"	EXU242464V5
30"	EXU243064V5
36"	EXU243664V5
42"	EXU244264V5
48"	EXU244864V5
54"	EXU245464V5
60"	EXU246064V5
72"	EXU247264V5

22"	EXA242464V5
28"	EXA243064V5
34"	EXA243664V5
40"	EXA244264V5
46"	EXA244864V5
52"	EXA245464V5
58"	EXA246064V5
70"	EXA247264V5

### Optional Accessories

- Corner Connector Sets
- Bottom Shelf Dunnage Stands (Low or Tall)
- Shelf Identification Tags
- Wall Fastener
- Floor Fastener
- Shelf Divider Panel
- Shelf Divider Bars (Straight or Angled)
- Single Shelf Sheet Pan Rack
- Single Shelf Security Cage
- Shelf Traverses (Single or Double)
- Drying and Storage Cradles
- Shelf Rails
- Universal Storage Rack
- Single and Add-on Can Racks

### Architect Specs

Posts and Traverses: Proprietary non-corrosive composite material.  
 Post Connectors: Reinforced polypropylene.  
 Shelf Plates: Reinforced polypropylene with Camguard® antimicrobial.  
 Corner Connectors: Reinforced nylon.  
 Adjustable Foot: Reinforced nylon.  
 Traverse Dovetails: Reinforced nylon.  
 Post Connector Collar Wedge: Reinforced nylon.

### Approvals



COMPONENT

Post Connectors, Corner Connectors, Floor Fastener, Wall Fastener, Identification Tags, Shelf Rails, Single Shelf Security Cage, Peg Board and Shelf Divider Bars are not NSF listed.

**CAMBRO®**

www.cambro.com

Information and specifications are subject to change without notice. Please confirm at time of order.

Telephone: (714) 848-1555 Toll Free: (800) 854-7631 Customer Service: (800) 833-3003

© Cambro Manufacturing Company Huntington Beach, California 92647

Printed in U.S.A. 09/23

EXCS1

D082307



# Camshelving® Elements XTRA Series

## Stationary Starter & Add-On Units 4 Solid or 4 Vented and Solid Shelves (3 Vented + 1 Solid)

HEIGHT	DEPTHS	LENGTHS	
1	3	8	
64"	18"	24"	48"
	21"	30"	54"
	24"	36"	60"
		42"	72"

- **Starter Units include:**  
2 factory assembled post kits, 8 or 10 shelf traverses, traverse dovetails and shelf plates.
- **Add-On Units include:**  
1 factory assembled post kit, 8 or 10 shelf traverses, traverse dovetails and shelf plates.

All units ship complete in 1 box.



### Features & Benefits

- Designed to easily support the performance demands of a busy foodservice operation with medium to heavy storage needs.
- Use in walk-in coolers, freezers, dry storage, warewashing areas, loading docks or front of the house. Withstands storage temperatures -36° to 190°F (-38° to 88°C). Impervious to moisture, chemicals, salt, food acids and humidity.
- Posts and traverses are made of a revolutionary, extremely strong composite material with a smooth, easy to clean surface. Stronger than common wire shelving and lighter in weight than Camshelving Premium Series. Traverse dovetails are separate from the posts and attach easily to secure the shelf traverses.
- Smooth polypropylene shelf plates contain Camguard, an antimicrobial technology that inhibits the growth of mold, fungus and bacteria that may cause odors, stains and product degradation.
- Shelving Units interconnect in straight lines with shared posts. Uniquely engineered Post Connectors offer exceptional cross stabilization. Weight bearing is uncompromised and space is maximized. No add-on clips or "S" hooks required.
- Easily install heavy-duty Corner Connectors (front and back clasp design) to add shelves in corners or to install middle shelves between 2 units without any loss of weight bearing. Maximizes usable and easy to access storage space.
- Posts and traverses wipe clean. Traverses and shelf plates remove easily for cleaning.
- Shelf traverses can be removed and adjusted at 4" (10,2) cm increments.
- Sturdy reinforced nylon foot adjusts easily to level units.
- Requires some assembly with minimal parts. Use a rubber mallet only.
- Lifetime warranty against rust and corrosion (posts, traverses and shelf plates).
- Available in 1 color – Speckled Gray (480).

Project \_\_\_\_\_

Item No. \_\_\_\_\_

Model No. \_\_\_\_\_

Quantity \_\_\_\_\_



Stationary Starter Unit



Stationary Add-On Unit

## WEIGHT BEARING CAPACITY

Weight must be evenly distributed across the entire shelf.

		UNIT LENGTH 24" – 60"	UNIT LENGTH 72"
<b>SINGLE UNIT</b>	Unit only	2400 lbs.	2400 lbs.
	Shelf only	800	600
	Unit with dunnage stand*	2800	2700
	Bottom shelf with dunnage stand*	1200	900

		UNIT LENGTH 24" – 60"	
<b>CORNER UNIT</b> With 2 Dunnage Stands required	Unit only	2400	—
	Shelf only	800	—
	Bottom shelf with dunnage stands*	1200	—

		UNIT LENGTH 24" – 60"	
<b>INTERMEDIATE SHELVES</b> Shelves Installed Between 2 Units	Unit only	2400	—
	Shelf only	800	—
	Bottom shelf with dunnage stands*	1200	—

\*Dunnage Stands add stability and increase weight bearing capacity on bottom shelf only. Add to any shelf length. Highly recommended for Starter Units 54" (1375 mm) and longer, all Corner Units, U-Shape Units and units specified for heavier loads.

### Approvals



Post Connectors, Corner Connectors, Floor Fastener, Wall Fastener, Identification Tags, Shelf Rails, Single Shelf Security Cage, Peg Board and Shelf Divider Bars are not NSF listed.



Information and specifications are subject to change without notice. Please confirm at time of order.

Telephone: (714) 848-1555 Toll Free: (800) 854-7631 Customer Service: (800) 833-3003

© Cambro Manufacturing Company Huntington Beach, California 92647

Printed in U.S.A. 09/23

www.cambro.com

# Camshelving® Elements XTRA Series

**Stationary Starter & Add-On Units**  
**4 Solid or 4 Vented and Solid Shelves**  
 (3 Vented + 1 Solid)

Project \_\_\_\_\_

Item No. \_\_\_\_\_

Model No. \_\_\_\_\_

Quantity \_\_\_\_\_

## S4

### 4-Shelf Solid Units

Starter



Add-On

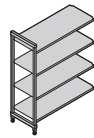

**64"**  
HEIGHT

**18"**  
DEPTH

**21"**  
DEPTH

**24"**  
DEPTH

LENGTH	CODE
24"	EXU182464S4
30"	EXU183064S4
36"	EXU183664S4
42"	EXU184264S4
48"	EXU184864S4
54"	EXU185464S4
60"	EXU186064S4
72"	EXU187264S4

LENGTH	CODE
22"	EXA182464S4
28"	EXA183064S4
34"	EXA183664S4
40"	EXA184264S4
46"	EXA184864S4
52"	EXA185464S4
58"	EXA186064S4
70"	EXA187264S4

24"	EXU212464S4
30"	EXU213064S4
36"	EXU213664S4
42"	EXU214264S4
48"	EXU214864S4
54"	EXU215464S4
60"	EXU216064S4
72"	EXU217264S4

22"	EXA212464S4
28"	EXA213064S4
34"	EXA213664S4
40"	EXA214264S4
46"	EXA214864S4
52"	EXA215464S4
58"	EXA216064S4
70"	EXA217264S4

24"	EXU242464S4
30"	EXU243064S4
36"	EXU243664S4
42"	EXU244264S4
48"	EXU244864S4
54"	EXU245464S4
60"	EXU246064S4
72"	EXU247264S4

22"	EXA242464S4
28"	EXA243064S4
34"	EXA243664S4
40"	EXA244264S4
46"	EXA244864S4
52"	EXA245464S4
58"	EXA246064S4
70"	EXA247264S4

Color: Speckled Gray (480).

## VS4

### 4-Shelf Units (3 Vented + 1 Solid)

Starter

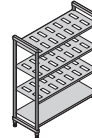

Add-On

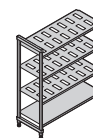

LENGTH	CODE
24"	EXU182464VS4
30"	EXU183064VS4
36"	EXU183664VS4
42"	EXU184264VS4
48"	EXU184864VS4
54"	EXU185464VS4
60"	EXU186064VS4
72"	EXU187264VS4

LENGTH	CODE
22"	EXA182464VS4
28"	EXA183064VS4
34"	EXA183664VS4
40"	EXA184264VS4
46"	EXA184864VS4
52"	EXA185464VS4
58"	EXA186064VS4
70"	EXA187264VS4

24"	EXU212464VS4
30"	EXU213064VS4
36"	EXU213664VS4
42"	EXU214264VS4
48"	EXU214864VS4
54"	EXU215464VS4
60"	EXU216064VS4
72"	EXU217264VS4

22"	EXA212464VS4
28"	EXA213064VS4
34"	EXA213664VS4
40"	EXA214264VS4
46"	EXA214864VS4
52"	EXA215464VS4
58"	EXA216064VS4
70"	EXA217264VS4

24"	EXU242464VS4
30"	EXU243064VS4
36"	EXU243664VS4
42"	EXU244264VS4
48"	EXU244864VS4
54"	EXU245464VS4
60"	EXU246064VS4
72"	EXU247264VS4

22"	EXA242464VS4
28"	EXA243064VS4
34"	EXA243664VS4
40"	EXA244264VS4
46"	EXA244864VS4
52"	EXA245464VS4
58"	EXA246064VS4
70"	EXA247264VS4

## Optional Accessories

- Corner Connector Sets
- Bottom Shelf Dunnage Stands (Low or Tall)
- Shelf Identification Tags
- Wall Fastener
- Floor Fastener
- Shelf Divider Panel
- Shelf Divider Bars (Straight or Angled)
- Single Shelf Sheet Pan Rack
- Single Shelf Security Cage
- Shelf Traverses (Single or Double)
- Shelf Rails
- Universal Storage Rack
- Single and Add-on Can Racks

## Architect Specs

Posts and Traverses: Proprietary non-corrosive composite material.  
 Post Connectors: Reinforced polypropylene.  
 Shelf Plates: Reinforced polypropylene with Camguard® antimicrobial.  
 Corner Connectors: Reinforced nylon.  
 Adjustable Foot: Reinforced nylon.  
 Traverse Dovetails: Reinforced nylon.  
 Post Connector Collar Wedge: Reinforced nylon.

## Approvals



COMPONENT

Post Connectors, Corner Connectors, Floor Fastener, Wall Fastener, Identification Tags, Shelf Rails, Single Shelf Security Cage, Peg Board and Shelf Divider Bars are not NSF listed.

# CAMBRO®

www.cambro.com

Information and specifications are subject to change without notice. Please confirm at time of order.

Telephone: (714) 848-1555 Toll Free: (800) 854-7631 Customer Service: (800) 833-3003

© Cambro Manufacturing Company Huntington Beach, California 92647

Printed in U.S.A. 09/23

EXCS2

D082307





# Camshelving® Elements XTRA Series

## Stationary Starter & Add-On Units 4 or 5 Vented Shelves

HEIGHT	DEPTHS	LENGTHS	
1	3	8	
72"	18"	24"	48"
	21"	30"	54"
	24"	36"	60"
		42"	72"

- **Starter Units include:**  
2 factory assembled post kits, 8 or 10 shelf traverses, traverse dovetails and shelf plates.
- **Add-On Units include:**  
1 factory assembled post kit, 8 or 10 shelf traverses, traverse dovetails and shelf plates.

All units ship complete in 1 box.



### Features & Benefits

- Designed to easily support the performance demands of a busy foodservice operation with medium to heavy storage needs.
- Use in walk-in coolers, freezers, dry storage, warewashing areas, loading docks or front of the house. Withstands storage temperatures -36° to 190°F (-38° to 88°C). Impervious to moisture, chemicals, salt, food acids and humidity.
- Posts and traverses are made of a revolutionary, extremely strong composite material with a smooth, easy to clean surface. Stronger than common wire shelving and lighter in weight than Camshelving Premium Series. Traverse dovetails are separate from the posts and attach easily to secure the shelf traverses.
- Smooth polypropylene shelf plates contain Camguard, an antimicrobial technology that inhibits the growth of mold, fungus and bacteria that may cause odors, stains and product degradation.
- Shelving Units interconnect in straight lines with shared posts. Uniquely engineered Post Connectors offer exceptional cross stabilization. Weight bearing is uncompromised and space is maximized. No add-on clips or "S" hooks required.
- Easily install heavy-duty Corner Connectors (front and back clasp design) to add shelves in corners or to install middle shelves between 2 units without any loss of weight bearing. Maximizes usable, easy access storage space.
- Posts and traverses wipe clean. Traverses and shelf plates remove easily for cleaning.
- Shelf traverses can be removed and adjusted at 4" (10,2 cm) increments.
- Sturdy reinforced nylon foot adjusts easily to level units.
- Requires some assembly with minimal parts. Use a rubber mallet only.
- Lifetime warranty against rust and corrosion (posts, traverses and shelf plates).
- Available in 1 color – Speckled Gray (480).

Project \_\_\_\_\_

Item No. \_\_\_\_\_

Model No. \_\_\_\_\_

Quantity \_\_\_\_\_



Stationary Starter Unit



Stationary Starter and Add-On Unit

## WEIGHT BEARING CAPACITY

Weight must be evenly distributed across the entire shelf.

		UNIT LENGTH 24" – 60"	UNIT LENGTH 72"
<b>SINGLE UNIT</b>	Unit only	2400 lbs.	2400 lbs.
	Shelf only	800	600
	Unit with dunnage stand*	2800	2700
	Bottom shelf with dunnage stand*	1200	900

		UNIT LENGTH 24" – 60"	
<b>CORNER UNIT</b> With 2 Dunnage Stands required	Unit only	2400	—
	Shelf only	800	—
	Bottom shelf with dunnage stands*	1200	—

		UNIT LENGTH 24" – 60"	
<b>INTERMEDIATE SHELVES</b> Shelves Installed Between 2 Units	Unit only	2400	—
	Shelf only	800	—
	Bottom shelf with dunnage stands*	1200	—

\*Dunnage Stands add stability and increase weight bearing capacity on bottom shelf only. Add to any shelf length. Highly recommended for Starter Units 54" (1375 mm) and longer, all Corner Units, U-Shape Units and units specified for heavier loads.

### Approvals



Post Connectors, Corner Connectors, Floor Fastener, Wall Fastener, Identification Tags, Shelf Rails, Single Shelf Security Cage, Peg Board and Shelf Divider Bars are not NSF listed.



Information and specifications are subject to change without notice. Please confirm at time of order.

Telephone: (714) 848-1555 Toll Free: (800) 854-7631 Customer Service: (800) 833-3003

© Cambro Manufacturing Company Huntington Beach, California 92647

Printed in U.S.A. 09/23

www.cambro.com

# Camshelving® Elements XTRA Series

## Stationary Starter & Add-On Units 4 or 5 Vented Shelves

Project \_\_\_\_\_

Item No. \_\_\_\_\_

Model No. \_\_\_\_\_

Quantity \_\_\_\_\_

### V4

#### 4-Shelf Vented Units

Starter

Add-On

**72"**  
HEIGHT

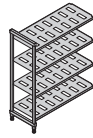

**18"**  
DEPTH

LENGTH	CODE
24"	EXU182472V4
30"	EXU183072V4
36"	EXU183672V4
42"	EXU184272V4
48"	EXU184872V4
54"	EXU185472V4
60"	EXU186072V4
72"	EXU187272V4

LENGTH	CODE
22"	EXA182472V4
28"	EXA183072V4
34"	EXA183672V4
40"	EXA184272V4
46"	EXA184872V4
52"	EXA185472V4
58"	EXA186072V4
70"	EXA187272V4

**21"**  
DEPTH

24"	EXU212472V4
30"	EXU213072V4
36"	EXU213672V4
42"	EXU214272V4
48"	EXU214872V4
54"	EXU215472V4
60"	EXU216072V4
72"	EXU217272V4

22"	EXA212472V4
28"	EXA213072V4
34"	EXA213672V4
40"	EXA214272V4
46"	EXA214872V4
52"	EXA215472V4
58"	EXA216072V4
70"	EXA217272V4

**24"**  
DEPTH

24"	EXU242472V4
30"	EXU243072V4
36"	EXU243672V4
42"	EXU244272V4
48"	EXU244872V4
54"	EXU245472V4
60"	EXU246072V4
72"	EXU247272V4

22"	EXA242472V4
28"	EXA243072V4
34"	EXA243672V4
40"	EXA244272V4
46"	EXA244872V4
52"	EXA245472V4
58"	EXA246072V4
70"	EXA247272V4

Color: Speckled Gray (480).

### V5

#### 5-Shelf Vented Units

Starter

Add-On

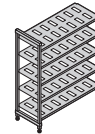
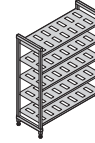

LENGTH	CODE
24"	EXU182472V5
30"	EXU183072V5
36"	EXU183672V5
42"	EXU184272V5
48"	EXU184872V5
54"	EXU185472V5
60"	EXU186072V5
72"	EXU187272V5

LENGTH	CODE
22"	EXA182472V5
28"	EXA183072V5
34"	EXA183672V5
40"	EXA184272V5
46"	EXA184872V5
52"	EXA185472V5
58"	EXA186072V5
70"	EXA187272V5

24"	EXU212472V5
30"	EXU213072V5
36"	EXU213672V5
42"	EXU214272V5
48"	EXU214872V5
54"	EXU215472V5
60"	EXU216072V5
72"	EXU217272V5

22"	EXA212472V5
28"	EXA213072V5
34"	EXA213672V5
40"	EXA214272V5
46"	EXA214872V5
52"	EXA215472V5
58"	EXA216072V5
70"	EXA217272V5

24"	EXU242472V5
30"	EXU243072V5
36"	EXU243672V5
42"	EXU244272V5
48"	EXU244872V5
54"	EXU245472V5
60"	EXU246072V5
72"	EXU247272V5

22"	EXA242472V5
28"	EXA243072V5
34"	EXA243672V5
40"	EXA244272V5
46"	EXA244872V5
52"	EXA245472V5
58"	EXA246072V5
70"	EXA247272V5

### Optional Accessories

- Corner Connector Sets
- Bottom Shelf Dunnage Stands (Low or Tall)
- Shelf Identification Tags
- Wall Fastener
- Floor Fastener
- Shelf Divider Panel
- Shelf Divider Bars (Straight or Angled)
- Single Shelf Sheet Pan Rack
- Single Shelf Security Cage
- Shelf Traverses (Single or Double)
- Drying and Storage Cradles
- Shelf Rails
- Universal Storage Rack
- Single and Add-on Can Racks

### Architect Specs

Posts and Traverses: Proprietary non-corrosive composite material.  
 Post Connectors: Reinforced polypropylene.  
 Shelf Plates: Reinforced polypropylene with Camguard® antimicrobial.  
 Corner Connectors: Reinforced nylon.  
 Adjustable Foot: Reinforced nylon.  
 Traverse Dovetails: Reinforced nylon.  
 Post Connector Collar Wedge: Reinforced nylon.

### Approvals



COMPONENT

Post Connectors, Corner Connectors, Floor Fastener, Wall Fastener, Identification Tags, Shelf Rails, Single Shelf Security Cage, Peg Board and Shelf Divider Bars are not NSF listed.

**CAMBRO**

www.cambro.com

Information and specifications are subject to change without notice. Please confirm at time of order.

Telephone: (714) 848-1555 Toll Free: (800) 854-7631 Customer Service: (800) 833-3003

© Cambro Manufacturing Company Huntington Beach, California 92647

Printed in U.S.A. 09/23

EXCS3

D082307



# Camshelving® Elements XTRA Series

## Stationary Starter & Add-On Units 4 Solid or 4 Vented and Solid Shelves (3 Vented + 1 Solid)

HEIGHT	DEPTHS	LENGTHS	
1	3	8	
72"	18"	24"	48"
	21"	30"	54"
	24"	36"	60"
		42"	72"

- **Starter Units include:**  
2 factory assembled post kits, 8 or 10 shelf traverses, traverse dovetails and shelf plates.
- **Add-On Units include:**  
1 factory assembled post kit, 8 or 10 shelf traverses, traverse dovetails and shelf plates.

All units ship complete in 1 box.



### Features & Benefits

- Designed to easily support the performance demands of a busy foodservice operation with medium to heavy storage needs.
- Use in walk-in coolers, freezers, dry storage, warewashing areas, loading docks or front of the house. Withstands storage temperatures -36° to 190°F (-38° to 88°C). Impervious to moisture, chemicals, salt, food acids and humidity.
- Posts and traverses are made of a revolutionary, extremely strong composite material with a smooth, easy to clean surface. Stronger than common wire shelving and lighter in weight than Camshelving Premium Series. Traverse dovetails are separate from the posts and attach easily to secure the shelf traverses.
- Smooth polypropylene shelf plates contain Camguard, an antimicrobial technology that inhibits the growth of mold, fungus and bacteria that may cause odors, stains and product degradation.
- Shelving Units interconnect in straight lines with shared posts. Uniquely engineered Post Connectors offer exceptional cross stabilization. Weight bearing is uncompromised and space is maximized. No add-on clips or "S" hooks required.
- Easily install heavy-duty Corner Connectors (front and back clasp design) to add shelves in corners or to install middle shelves between 2 units without any loss of weight bearing. Maximizes usable, easy access storage space.
- Posts and traverses wipe clean. Traverses and shelf plates remove easily for cleaning.
- Shelf traverses can be removed and adjusted at 4" (10,2 cm) increments.
- Sturdy reinforced nylon foot adjusts easily to level units.
- Requires some assembly with minimal parts. Use a rubber mallet only.
- Lifetime warranty against rust and corrosion (posts, traverses and shelf plates).
- Available in 1 color – Speckled Gray (480).

Project \_\_\_\_\_

Item No. \_\_\_\_\_

Model No. \_\_\_\_\_

Quantity \_\_\_\_\_



Stationary Starter Unit



Stationary Add-On Unit

## WEIGHT BEARING CAPACITY

Weight must be evenly distributed across the entire shelf.

		UNIT LENGTH 24" – 60"	UNIT LENGTH 72"
<b>SINGLE UNIT</b>	Unit only	2400 lbs.	2400 lbs.
	Shelf only	800	600
	Unit with dunnage stand*	2800	2700
	Bottom shelf with dunnage stand*	1200	900

		UNIT LENGTH 24" – 60"	
<b>CORNER UNIT</b> With 2 Dunnage Stands required	Unit only	2400	—
	Shelf only	800	—
	Bottom shelf with dunnage stands*	1200	—

		UNIT LENGTH 24" – 60"	
<b>INTERMEDIATE SHELVES</b> Shelves Installed Between 2 Units	Unit only	2400	—
	Shelf only	800	—
	Bottom shelf with dunnage stands*	1200	—

\*Dunnage Stands add stability and increase weight bearing capacity on bottom shelf only. Add to any shelf length. Highly recommended for Starter Units 54" (1375 mm) and longer, all Corner Units, U-Shape Units and units specified for heavier loads.

### Approvals



Post Connectors, Corner Connectors, Floor Fastener, Wall Fastener, Identification Tags, Shelf Rails, Single Shelf Security Cage, Peg Board and Shelf Divider Bars are not NSF listed.



Information and specifications are subject to change without notice. Please confirm at time of order.

Telephone: (714) 848-1555 Toll Free: (800) 854-7631 Customer Service: (800) 833-3003

© Cambro Manufacturing Company Huntington Beach, California 92647

Printed in U.S.A. 09/23

www.cambro.com

# Camshelving® Elements XTRA Series

**Stationary Starter & Add-On Units**  
**4 Solid or 4 Vented and Solid Shelves**  
 (3 Vented + 1 Solid)

Project \_\_\_\_\_

Item No. \_\_\_\_\_

Model No. \_\_\_\_\_

Quantity \_\_\_\_\_

## S4

### 4-Shelf Solid Units

Starter



Add-On

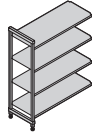

**72"**  
HEIGHT

**18"**  
DEPTH

**21"**  
DEPTH

**24"**  
DEPTH

LENGTH	CODE
24"	EXU182472S4
30"	EXU183072S4
36"	EXU183672S4
42"	EXU184272S4
48"	EXU184872S4
54"	EXU185472S4
60"	EXU186072S4
72"	EXU187272S4

LENGTH	CODE
22"	EXA182472S4
28"	EXA183072S4
34"	EXA183672S4
40"	EXA184272S4
46"	EXA184872S4
52"	EXA185472S4
58"	EXA186072S4
70"	EXA187272S4

24"	EXU212472S4
30"	EXU213072S4
36"	EXU213672S4
42"	EXU214272S4
48"	EXU214872S4
54"	EXU215472S4
60"	EXU216072S4
72"	EXU217272S4

22"	EXA212472S4
28"	EXA213072S4
34"	EXA213672S4
40"	EXA214272S4
46"	EXA214872S4
52"	EXA215472S4
58"	EXA216072S4
70"	EXA217272S4

24"	EXU242472S4
30"	EXU243072S4
36"	EXU243672S4
42"	EXU244272S4
48"	EXU244872S4
54"	EXU245472S4
60"	EXU246072S4
72"	EXU247272S4

22"	EXA242472S4
28"	EXA243072S4
34"	EXA243672S4
40"	EXA244272S4
46"	EXA244872S4
52"	EXA245472S4
58"	EXA246072S4
70"	EXA247272S4

Color: Speckled Gray (480).

## VS4

### 4-Shelf Units (3 Vented + 1 Solid)

Starter

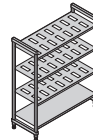

Add-On

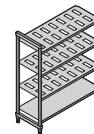

LENGTH	CODE
24"	EXU182472VS4
30"	EXU183072VS4
36"	EXU183672VS4
42"	EXU184272VS4
48"	EXU184872VS4
54"	EXU185472VS4
60"	EXU186072VS4
72"	EXU187272VS4

LENGTH	CODE
22"	EXA182472VS4
28"	EXA183072VS4
34"	EXA183672VS4
40"	EXA184272VS4
46"	EXA184872VS4
52"	EXA185472VS4
58"	EXA186072VS4
70"	EXA187272VS4

24"	EXU212472VS4
30"	EXU213072VS4
36"	EXU213672VS4
42"	EXU214272VS4
48"	EXU214872VS4
54"	EXU215472VS4
60"	EXU216072VS4
72"	EXU217272VS4

22"	EXA212472VS4
28"	EXA213072VS4
34"	EXA213672VS4
40"	EXA214272VS4
46"	EXA214872VS4
52"	EXA215472VS4
58"	EXA216072VS4
70"	EXA217272VS4

24"	EXU242472VS4
30"	EXU243072VS4
36"	EXU243672VS4
42"	EXU244272VS4
48"	EXU244872VS4
54"	EXU245472VS4
60"	EXU246072VS4
72"	EXU247272VS4

22"	EXA242472VS4
28"	EXA243072VS4
34"	EXA243672VS4
40"	EXA244272VS4
46"	EXA244872VS4
52"	EXA245472VS4
58"	EXA246072VS4
70"	EXA247272VS4

## Optional Accessories

- Corner Connector Sets
- Bottom Shelf Dunnage Stands (Low or Tall)
- Shelf Identification Tags
- Wall Fastener
- Floor Fastener
- Shelf Divider Panel
- Shelf Divider Bars (Straight or Angled)
- Single Shelf Sheet Pan Rack
- Single Shelf Security Cage
- Shelf Traverses (Single or Double)
- Drying and Storage Cradles
- Shelf Rails
- Universal Storage Rack
- Single and Add-on Can Racks

## Architect Specs

Posts and Traverses: Proprietary non-corrosive composite material.  
 Post Connectors: Reinforced polypropylene.  
 Shelf Plates: Reinforced polypropylene with Camguard® antimicrobial.  
 Corner Connectors: Reinforced nylon.  
 Adjustable Foot: Reinforced nylon.  
 Traverse Dovetails: Reinforced nylon.  
 Post Connector Collar Wedge: Reinforced nylon.

## Approvals



Post Connectors, Corner Connectors, Floor Fastener, Wall Fastener, Identification Tags, Shelf Rails, Single Shelf Security Cage, Peg Board and Shelf Divider Bars are not NSF listed.

# CAMBRO®

www.cambro.com

Information and specifications are subject to change without notice. Please confirm at time of order.

Telephone: (714) 848-1555 Toll Free: (800) 854-7631 Customer Service: (800) 833-3003

© Cambro Manufacturing Company Huntington Beach, California 92647

Printed in U.S.A. 09/23

EXCS4

D082307



# Camshelving® Elements XTRA Series

## Stationary Starter & Add-On Units 4 or 5 Vented Shelves

HEIGHT	DEPTHS	LENGTHS	
1	3	8	
84"	18"	24"	48"
	21"	30"	54"
	24"	36"	60"
		42"	72"

- **Starter Units include:**  
2 factory assembled post kits, 8 or 10 shelf traverses, traverse dovetails and shelf plates.
- **Add-On Units include:**  
1 factory assembled post kit, 8 or 10 shelf traverses, traverse dovetails and shelf plates.

All units ship complete in 1 box.



### Features & Benefits

- Designed to easily support the performance demands of a busy foodservice operation with medium to heavy storage needs.
- Use in walk-in coolers, freezers, dry storage, warewashing areas, loading docks or front of the house. Withstands storage temperatures -36° to 190°F (-38° to 88°C). Impervious to moisture, chemicals, salt, food acids and humidity.
- Posts and traverses are made of a revolutionary, extremely strong composite material with a smooth, easy to clean surface. Stronger than common wire shelving and lighter in weight than Camshelving Premium Series. Traverse dovetails are separate from the posts and attach easily to secure the shelf traverses.
- Smooth polypropylene shelf plates contain Camguard, an antimicrobial technology that inhibits the growth of mold, fungus and bacteria that may cause odors, stains and product degradation.
- Shelving Units interconnect in straight lines with shared posts. Uniquely engineered Post Connectors offer exceptional cross stabilization. Weight bearing is uncompromised and space is maximized. No add-on clips or "S" hooks required.
- Easily install heavy-duty Corner Connectors (front and back clasp design) to add shelves in corners or to install middle shelves between 2 units without any loss of weight bearing. Maximizes usable, easy access storage space.
- Posts and traverses wipe clean. Traverses and shelf plates remove easily for cleaning.
- Shelf traverses can be removed and adjusted at 4" (10,2 cm) increments.
- Sturdy reinforced nylon foot adjusts easily to level units.
- Requires some assembly with minimal parts. Use a rubber mallet only.
- Lifetime warranty against rust and corrosion (posts, traverses and shelf plates).
- Available in 1 color – Speckled Gray (480).

Project \_\_\_\_\_

Item No. \_\_\_\_\_

Model No. \_\_\_\_\_

Quantity \_\_\_\_\_



Stationary Starter Unit



Stationary Starter and Add-On Unit

## WEIGHT BEARING CAPACITY

Weight must be evenly distributed across the entire shelf.

		UNIT LENGTH 24" – 60"	UNIT LENGTH 72"
<b>SINGLE UNIT</b>	Unit only	2400 lbs.	2400 lbs.
	Shelf only	800	600
	Unit with dunnage stand*	2800	2700
	Bottom shelf with dunnage stand*	1200	900
		UNIT LENGTH 24" – 60"	
<b>CORNER UNIT</b> With 2 Dunnage Stands required	Unit only	2400	—
	Shelf only	800	—
	Bottom shelf with dunnage stands*	1200	—
		UNIT LENGTH 24" – 60"	
<b>INTERMEDIATE SHELVES</b> Shelves Installed Between 2 Units	Unit only	2400	—
	Shelf only	800	—
	Bottom shelf with dunnage stands*	1200	—

\*Dunnage Stands add stability and increase weight bearing capacity on bottom shelf only. Add to any shelf length. Highly recommended for Starter Units 54" (1375 mm) and longer, all Corner Units, U-Shape Units and units specified for heavier loads.

### Approvals



Post Connectors, Corner Connectors, Floor Fastener, Wall Fastener, Identification Tags, Shelf Rails, Single Shelf Security Cage, Peg Board and Shelf Divider Bars are not NSF listed.



Information and specifications are subject to change without notice. Please confirm at time of order.

Telephone: (714) 848-1555 Toll Free: (800) 854-7631 Customer Service: (800) 833-3003  
 © Cambro Manufacturing Company Huntington Beach, California 92647  
 Printed in U.S.A. 09/23

www.cambro.com



# Camshelving® Elements XTRA Series

## Stationary Starter & Add-On Units 4 or 5 Vented Shelves

Project \_\_\_\_\_

Item No. \_\_\_\_\_

Model No. \_\_\_\_\_

Quantity \_\_\_\_\_

### V4

#### 4-Shelf Vented Units

Starter

Add-On

**84"**  
HEIGHT

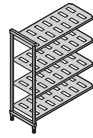

**18"**  
DEPTH

LENGTH	CODE
24"	EXU182484V4
30"	EXU183084V4
36"	EXU183684V4
42"	EXU184284V4
48"	EXU184884V4
54"	EXU185484V4
60"	EXU186084V4
72"	EXU188484V4

LENGTH	CODE
22"	EXA182484V4
28"	EXA183084V4
34"	EXA183684V4
40"	EXA184284V4
46"	EXA184884V4
52"	EXA185484V4
58"	EXA186084V4
70"	EXA187284V4

**21"**  
DEPTH

24"	EXU212484V4
30"	EXU213084V4
36"	EXU213684V4
42"	EXU214284V4
48"	EXU214884V4
54"	EXU215484V4
60"	EXU216084V4
72"	EXU217284V4

22"	EXA212484V4
28"	EXA213084V4
34"	EXA213684V4
40"	EXA214284V4
46"	EXA214884V4
52"	EXA215484V4
58"	EXA216084V4
70"	EXA218484V4

**24"**  
DEPTH

24"	EXU242484V4
30"	EXU243084V4
36"	EXU243684V4
42"	EXU244284V4
48"	EXU244884V4
54"	EXU245484V4
60"	EXU246084V4
72"	EXU247284V4

22"	EXA242484V4
28"	EXA243084V4
34"	EXA243684V4
40"	EXA244284V4
46"	EXA244884V4
52"	EXA245484V4
58"	EXA246084V4
70"	EXA247284V4

Color: Speckled Gray (480).

### V5

#### 5-Shelf Vented Units

Starter

Add-On

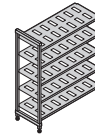
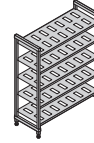

LENGTH	CODE
24"	EXU182484V5
30"	EXU183084V5
36"	EXU183684V5
42"	EXU184284V5
48"	EXU184884V5
54"	EXU185484V5
60"	EXU186084V5
72"	EXU187284V5

LENGTH	CODE
22"	EXA182484V5
28"	EXA183084V5
34"	EXA183684V5
40"	EXA184284V5
46"	EXA184884V5
52"	EXA185484V5
58"	EXA186084V5
70"	EXA187284V5

24"	EXU212484V5
30"	EXU213084V5
36"	EXU213684V5
42"	EXU214284V5
48"	EXU214884V5
54"	EXU215484V5
60"	EXU216084V5
72"	EXU217284V5

22"	EXA212484V5
28"	EXA213084V5
34"	EXA213684V5
40"	EXA214284V5
46"	EXA214884V5
52"	EXA215484V5
58"	EXA216084V5
70"	EXA217284V5

24"	EXU242484V5
30"	EXU243084V5
36"	EXU243684V5
42"	EXU244284V5
48"	EXU244884V5
54"	EXU245484V5
60"	EXU246084V5
72"	EXU247284V5

22"	EXA242484V5
28"	EXA243084V5
34"	EXA243684V5
40"	EXA244284V5
46"	EXA244884V5
52"	EXA245484V5
58"	EXA246084V5
70"	EXA247284V5

### Optional Accessories

- Corner Connector Sets
- Bottom Shelf Dunnage Stands (Low or Tall)
- Shelf Identification Tags
- Wall Fastener
- Floor Fastener
- Shelf Divider Panel
- Shelf Divider Bars (Straight or Angled)
- Single Shelf Sheet Pan Rack
- Single Shelf Security Cage
- Shelf Traverses (Single or Double)
- Drying and Storage Cradles
- Shelf Rails
- Universal Storage Rack
- Single and Add-on Can Racks

### Architect Specs

Posts and Traverses: Proprietary non-corrosive composite material.  
 Post Connectors: Reinforced polypropylene.  
 Shelf Plates: Reinforced polypropylene with Camguard® antimicrobial.  
 Corner Connectors: Reinforced nylon.  
 Adjustable Foot: Reinforced nylon.  
 Traverse Dovetails: Reinforced nylon.  
 Post Connector Collar Wedge: Reinforced nylon.

### Approvals



Post Connectors, Corner Connectors, Floor Fastener, Wall Fastener, Identification Tags, Shelf Rails, Single Shelf Security Cage, Peg Board and Shelf Divider Bars are not NSF listed.

**CAMBRO®**

www.cambro.com

Information and specifications are subject to change without notice. Please confirm at time of order.

Telephone: (714) 848-1555 Toll Free: (800) 854-7631 Customer Service: (800) 833-3003

© Cambro Manufacturing Company Huntington Beach, California 92647

Printed in U.S.A. 09/23

EXCS5

D082307



# Camshelving® Elements XTRA Series

## Stationary Starter & Add-On Units 4 or 5 Solid Shelves

HEIGHT	DEPTHS	LENGTHS	
<b>1</b>	<b>3</b>	<b>8</b>	
84"	18"	24"	48"
	21"	30"	54"
	24"	36"	60"
		42"	72"

- **Starter Units include:**  
2 factory assembled post kits, 8 or 10 shelf traverses, traverse dovetails and shelf plates.
- **Add-On Units include:**  
1 factory assembled post kit, 8 or 10 shelf traverses, traverse dovetails and shelf plates.

All units ship complete in 1 box.



### Features & Benefits

- Designed to easily support the performance demands of a busy foodservice operation with medium to heavy storage needs.
- Use in walk-in coolers, freezers, dry storage, warewashing areas, loading docks or front of the house. Withstands storage temperatures -36° to 190°F (-38° to 88°C). Impervious to moisture, chemicals, salt, food acids and humidity.
- Posts and traverses are made of a revolutionary, extremely strong composite material with a smooth, easy to clean surface. Stronger than common wire shelving and lighter in weight than Camshelving Premium Series. Traverse dovetails are separate from the posts and attach easily to secure the shelf traverses.
- Smooth polypropylene shelf plates contain Camguard, an antimicrobial technology that inhibits the growth of mold, fungus and bacteria that may cause odors, stains and product degradation.
- Shelving Units interconnect in straight lines with shared posts. Uniquely engineered Post Connectors offer exceptional cross stabilization. Weight bearing is uncompromised and space is maximized. No add-on clips or "S" hooks required.
- Easily install heavy-duty Corner Connectors (front and back clasp design) to add shelves in corners or to install middle shelves between 2 units without any loss of weight bearing. Maximizes usable and easy to access storage space.
- Posts and traverses wipe clean. Traverses and shelf plates remove easily for cleaning.
- Shelf traverses can be removed and adjusted at 4" (10,2 cm) increments.
- Sturdy reinforced nylon foot adjusts easily to level units.
- Requires some assembly with minimal parts. Use a rubber mallet only.
- Lifetime warranty against rust and corrosion (posts, traverses and shelf plates).
- Available in 1 color – Speckled Gray (480).

Project \_\_\_\_\_  
 Item No. \_\_\_\_\_  
 Model No. \_\_\_\_\_  
 Quantity \_\_\_\_\_



Stationary Starter Unit



Stationary Add-On Unit

## WEIGHT BEARING CAPACITY

Weight must be evenly distributed across the entire shelf.

		UNIT LENGTH 24" – 60"	UNIT LENGTH 72"
<b>SINGLE UNIT</b>	Unit only	2400 lbs.	2400 lbs.
	Shelf only	800	600
	Unit with dunnage stand*	2800	2700
	Bottom shelf with dunnage stand*	1200	900
		UNIT LENGTH 24" – 60"	
<b>CORNER UNIT</b> With 2 Dunnage Stands required	Unit only	2400	—
	Shelf only	800	—
	Bottom shelf with dunnage stands*	1200	—
		UNIT LENGTH 24" – 60"	
<b>INTERMEDIATE SHELVES</b> Shelves Installed Between 2 Units	Unit only	2400	—
	Shelf only	800	—
	Bottom shelf with dunnage stands*	1200	—

\*Dunnage Stands add stability and increase weight bearing capacity on bottom shelf only. Add to any shelf length. Highly recommended for Starter Units 54" (1375 mm) and longer, all Corner Units, U-Shape Units and units specified for heavier loads.

### Approvals



Post Connectors, Corner Connectors, Floor Fastener, Wall Fastener, Identification Tags, Shelf Rails, Single Shelf Security Cage, Peg Board and Shelf Divider Bars are not NSF listed.



Information and specifications are subject to change without notice. Please confirm at time of order.

Telephone: (714) 848-1555 Toll Free: (800) 854-7631 Customer Service: (800) 833-3003

© Cambro Manufacturing Company Huntington Beach, California 92647

Printed in U.S.A. 09/23

www.cambro.com

# Camshelving® Elements XTRA Series

## Stationary Starter & Add-On Units 4 or 5 Solid Shelves

Project \_\_\_\_\_

Item No. \_\_\_\_\_

Model No. \_\_\_\_\_

Quantity \_\_\_\_\_

### S4

#### 4-Shelf Solid Units

Starter



Add-On

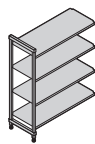

**84"**  
HEIGHT

**18"**  
DEPTH

**21"**  
DEPTH

**24"**  
DEPTH

LENGTH	CODE
24"	EXU182484S4
30"	EXU183084S4
36"	EXU183684S4
42"	EXU184284S4
48"	EXU184884S4
54"	EXU185484S4
60"	EXU186084S4
72"	EXU187284S4

LENGTH	CODE
22"	EXA182484S4
28"	EXA183084S4
34"	EXA183684S4
40"	EXA184284S4
46"	EXA184884S4
52"	EXA185484S4
58"	EXA186084S4
70"	EXA187284S4

24"	EXU212484S4
30"	EXU213084S4
36"	EXU213684S4
42"	EXU214284S4
48"	EXU214884S4
54"	EXU215484S4
60"	EXU216084S4
72"	EXU217284S4

22"	EXA212484S4
28"	EXA213084S4
34"	EXA213684S4
40"	EXA214284S4
46"	EXA214884S4
52"	EXA215484S4
58"	EXA216084S4
70"	EXA217284S4

24"	EXU242484S4
30"	EXU243084S4
36"	EXU243684S4
42"	EXU244284S4
48"	EXU244884S4
54"	EXU245484S4
60"	EXU246084S4
72"	EXU247284S4

22"	EXA242484S4
28"	EXA243084S4
34"	EXA243684S4
40"	EXA244284S4
46"	EXA244884S4
52"	EXA245484S4
58"	EXA246084S4
70"	EXA247284S4

Color: Speckled Gray (480).

### S5

#### 5-Shelf Solid Units

Starter

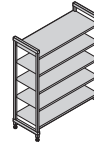

Add-On

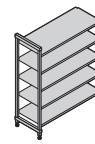

LENGTH	CODE
24"	EXU182484S5
30"	EXU183084S5
36"	EXU183684S5
42"	EXU184284S5
48"	EXU184884S5
54"	EXU185484S5
60"	EXU186084S5
72"	EXU187284S5

LENGTH	CODE
22"	EXA182484S5
28"	EXA183084S5
34"	EXA183684S5
40"	EXA184284S5
46"	EXA184884S5
52"	EXA185484S5
58"	EXA186084S5
70"	EXA187284S5

24"	EXU212484S5
30"	EXU213084S5
36"	EXU213684S5
42"	EXU214284S5
48"	EXU214884S5
54"	EXU215484S5
60"	EXU216084S5
72"	EXU217284S5

22"	EXA212484S5
28"	EXA213084S5
34"	EXA213684S5
40"	EXA214284S5
46"	EXA214884S5
52"	EXA215484S5
58"	EXA216084S5
70"	EXA217284S5

24"	EXU242484S5
30"	EXU243084S5
36"	EXU243684S5
42"	EXU244284S5
48"	EXU244884S5
54"	EXU245484S5
60"	EXU246084S5
72"	EXU247284S5

22"	EXA242484S5
28"	EXA243084S5
34"	EXA243684S5
40"	EXA244284S5
46"	EXA244884S5
52"	EXA245484S5
58"	EXA246084S5
70"	EXA247284S5

### Optional Accessories

- Corner Connector Sets
- Bottom Shelf Dunnage Stands (Low or Tall)
- Shelf Identification Tags
- Wall Fastener
- Floor Fastener
- Shelf Divider Panel
- Shelf Divider Bars (Straight or Angled)
- Single Shelf Sheet Pan Rack
- Single Shelf Security Cage
- Shelf Traverses (Single or Double)
- Drying and Storage Cradles
- Shelf Rails
- Universal Storage Rack
- Single and Add-on Can Racks

### Architect Specs

Posts and Traverses: Proprietary non-corrosive composite material.  
 Post Connectors: Reinforced polypropylene.  
 Shelf Plates: Reinforced polypropylene with Camguard® antimicrobial.  
 Corner Connectors: Reinforced nylon.  
 Adjustable Foot: Reinforced nylon.  
 Traverse Dovetails: Reinforced nylon.  
 Post Connector Collar Wedge: Reinforced nylon.

### Approvals



Post Connectors, Corner Connectors, Floor Fastener, Wall Fastener, Identification Tags, Shelf Rails, Single Shelf Security Cage, Peg Board and Shelf Divider Bars are not NSF listed.

**CAMBRO®**

www.cambro.com

Information and specifications are subject to change without notice. Please confirm at time of order.

Telephone: (714) 848-1555 Toll Free: (800) 854-7631 Customer Service: (800) 833-3003

© Cambro Manufacturing Company Huntington Beach, California 92647

Printed in U.S.A. 09/23

EXCS6

D082307



# Camshelving® Elements XTRA Series

## Stationary Starter & Add-On Units 4 or 5 Vented and Solid Shelves (3 Vented + 1 Solid or 4 Vented + 1 Solid)

HEIGHT	DEPTHS	LENGTHS	
1	3	8	
84"	18"	24"	48"
	21"	30"	54"
	24"	36"	60"
		42"	72"

- **Starter Units include:**  
2 factory assembled post kits, 8 or 10 shelf traverses, traverse dovetails and shelf plates.
- **Add-On Units include:**  
1 factory assembled post kit, 8 or 10 shelf traverses, traverse dovetails and shelf plates.

All units ship complete in 1 box.



### Features & Benefits

- Designed to easily support the performance demands of a busy foodservice operation with medium to heavy storage needs.
- Use in walk-in coolers, freezers, dry storage, warewashing areas, loading docks or front of the house. Withstands storage temperatures -36° to 190°F (-38° to 88°C). Impervious to moisture, chemicals, salt, food acids and humidity.
- Posts and traverses are made of a revolutionary, extremely strong composite material with a smooth, easy to clean surface. Stronger than common wire shelving and lighter in weight than Camshelving Premium Series. Traverse dovetails are separate from the posts and attach easily to secure the shelf traverses.
- Smooth polypropylene shelf plates contain Camguard, an antimicrobial technology that inhibits the growth of mold, fungus and bacteria that may cause odors, stains and product degradation.
- Shelving Units interconnect in straight lines with shared posts. Uniquely engineered Post Connectors offer exceptional cross stabilization. Weight bearing is uncompromised and space is maximized. No add-on clips or "S" hooks required.
- Easily install heavy-duty Corner Connectors (front and back clasp design) to add shelves in corners or to install middle shelves between 2 units without any loss of weight bearing. Maximizes usable and easy to access storage space.
- Posts and traverses wipe clean. Traverses and shelf plates remove easily for cleaning.
- Shelf traverses can be removed and adjusted at 4" (10,2 cm) increments.
- Sturdy reinforced nylon foot adjusts easily to level units.
- Requires some assembly with minimal parts. Use a rubber mallet only.
- Lifetime warranty against rust and corrosion (posts, traverses and shelf plates).
- Available in 1 color – Speckled Gray (480).

Project \_\_\_\_\_

Item No. \_\_\_\_\_

Model No. \_\_\_\_\_

Quantity \_\_\_\_\_



Stationary Starter Unit



Stationary Add-On Unit

## WEIGHT BEARING CAPACITY

Weight must be evenly distributed across the entire shelf.

		UNIT LENGTH 24" – 60"	UNIT LENGTH 72"
<b>SINGLE UNIT</b>	Unit only	2400 lbs.	2400 lbs.
	Shelf only	800	600
	Unit with dunnage stand*	2800	2700
	Bottom shelf with dunnage stand*	1200	900

		UNIT LENGTH 24" – 60"	
<b>CORNER UNIT</b> With 2 Dunnage Stands required	Unit only	2400	—
	Shelf only	800	—
	Bottom shelf with dunnage stands*	1200	—

		UNIT LENGTH 24" – 60"	
<b>INTERMEDIATE SHELVES</b> Shelves Installed Between 2 Units	Unit only	2400	—
	Shelf only	800	—
	Bottom shelf with dunnage stands*	1200	—

\*Dunnage Stands add stability and increase weight bearing capacity on bottom shelf only. Add to any shelf length. Highly recommended for Starter Units 54" (1375 mm) and longer, all Corner Units, U-Shape Units and units specified for heavier loads.

### Approvals



Post Connectors, Corner Connectors, Floor Fastener, Wall Fastener, Identification Tags, Shelf Rails, Single Shelf Security Cage, Peg Board and Shelf Divider Bars are not NSF listed.



Information and specifications are subject to change without notice. Please confirm at time of order.

Telephone: (714) 848-1555 Toll Free: (800) 854-7631 Customer Service: (800) 833-3003

© Cambro Manufacturing Company Huntington Beach, California 92647

Printed in U.S.A. 09/23

www.cambro.com

# Camshelving® Elements XTRA Series

**Stationary Starter & Add-On Units**  
**4 or 5 Vented and Solid Shelves (3 Vented + 1 Solid or 4 Vented + 1 Solid)**

Project \_\_\_\_\_

Item No. \_\_\_\_\_

Model No. \_\_\_\_\_

Quantity \_\_\_\_\_

## VS4

**4-Shelf Units (3 Vented + 1 Solid)**

**84"**  
HEIGHT

**Starter**

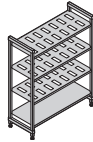

**Add-On**

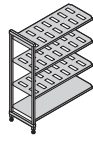

**18"**  
DEPTH

LENGTH	CODE
24"	EXU182484VS4
30"	EXU183084VS4
36"	EXU183684VS4
42"	EXU184284VS4
48"	EXU184884VS4
54"	EXU185484VS4
60"	EXU186084VS4
72"	EXU187284VS4

LENGTH	CODE
22"	EXA182484VS4
28"	EXA183084VS4
34"	EXA183684VS4
40"	EXA184284VS4
46"	EXA184884VS4
52"	EXA185484VS4
58"	EXA186084VS4
70"	EXA187284VS4

**21"**  
DEPTH

24"	EXU212484VS4
30"	EXU213084VS4
36"	EXU213684VS4
42"	EXU214284VS4
48"	EXU214884VS4
54"	EXU215484VS4
60"	EXU216084VS4
72"	EXU217284VS4

22"	EXA212484VS4
28"	EXA213084VS4
34"	EXA213684VS4
40"	EXA214284VS4
46"	EXA214884VS4
52"	EXA215484VS4
58"	EXA216084VS4
70"	EXA217284VS4

**24"**  
DEPTH

24"	EXU242484VS4
30"	EXU243084VS4
36"	EXU243684VS4
42"	EXU244284VS4
48"	EXU244884VS4
54"	EXU245484VS4
60"	EXU246084VS4
72"	EXU247284VS4

22"	EXA242484VS4
28"	EXA243084VS4
34"	EXA243684VS4
40"	EXA244284VS4
46"	EXA244884VS4
52"	EXA245484VS4
58"	EXA246084VS4
70"	EXA247284VS4

Color: Speckled Gray (480).

## VS5

**5-Shelf Units (4 Vented + 1 Solid)**

**Starter**

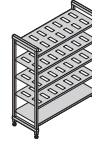

**Add-On**

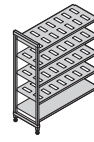

LENGTH	CODE
24"	EXU182484VS5
30"	EXU183084VS5
36"	EXU183684VS5
42"	EXU184284VS5
48"	EXU184884VS5
54"	EXU185484VS5
60"	EXU186084VS5
72"	EXU187284VS5

LENGTH	CODE
22"	EXA182484VS5
28"	EXA183084VS5
34"	EXA183684VS5
40"	EXA184284VS5
46"	EXA184884VS5
52"	EXA185484VS5
58"	EXA186084VS5
70"	EXA187284VS5

24"	EXU212484VS5
30"	EXU213084VS5
36"	EXU213684VS5
42"	EXU214284VS5
48"	EXU214884VS5
54"	EXU215484VS5
60"	EXU216084VS5
72"	EXU217284VS5

22"	EXA212484VS5
28"	EXA213084VS5
34"	EXA213684VS5
40"	EXA214284VS5
46"	EXA214884VS5
52"	EXA215484VS5
58"	EXA216084VS5
70"	EXA217284VS5

24"	EXU242484VS5
30"	EXU243084VS5
36"	EXU243684VS5
42"	EXU244284VS5
48"	EXU244884VS5
54"	EXU245484VS5
60"	EXU246084VS5
72"	EXU247284VS5

22"	EXA242484VS5
28"	EXA243084VS5
34"	EXA243684VS5
40"	EXA244284VS5
46"	EXA244884VS5
52"	EXA245484VS5
58"	EXA246084VS5
70"	EXA247284VS5

### Optional Accessories

- Corner Connector Sets
- Bottom Shelf Dunnage Stands (Low or Tall)
- Shelf Identification Tags
- Wall Fastener
- Floor Fastener
- Shelf Divider Panel
- Shelf Divider Bars (Straight or Angled)
- Single Shelf Sheet Pan Rack
- Single Shelf Security Cage
- Shelf Traverses (Single or Double)
- Drying and Storage Cradles
- Shelf Rails
- Universal Storage Rack
- Single and Add-on Can Racks

### Architect Specs

Posts and Traverses: Proprietary non-corrosive composite material.  
 Post Connectors: Reinforced polypropylene.  
 Shelf Plates: Reinforced polypropylene with Camguard® antimicrobial.  
 Corner Connectors: Reinforced nylon.  
 Adjustable Foot: Reinforced nylon.  
 Traverse Dovetails: Reinforced nylon.  
 Post Connector Collar Wedge: Reinforced nylon.

### Approvals



Post Connectors, Corner Connectors, Floor Fastener, Wall Fastener, Identification Tags, Shelf Rails, Single Shelf Security Cage, Peg Board and Shelf Divider Bars are not NSF listed.

**CAMBRO**

Information and specifications are subject to change without notice. Please confirm at time of order.

Telephone: (714) 848-1555 Toll Free: (800) 854-7631 Customer Service: (800) 833-3003

© Cambro Manufacturing Company Huntington Beach, California 92647

Printed in U.S.A. 09/23

www.cambro.com

EXCS7

D082307





# Camshelving® Elements XTRA Series

## Mobile Starter Units 4 or 5 Vented Shelves

HEIGHTS	DEPTHS	LENGTHS	
2	3	5	
70 ¼"	18"	36"	54"
78 ¼"	21" 24"	42" 48"	60"

- **Mobile Starter Units include:**  
2 factory assembled mobile post kits, 8 or 10 shelf traverses, traverse dovetails, shelf plates and 4 premium swivel casters with total locking brake.

All units ship complete in 1 box.



### Features & Benefits

- Use in walk-in coolers, freezers, dry storage, warewashing areas, loading docks or front of the house. Withstands storage temperatures -36° to 190°F (-38° to 88°C). Impervious to moisture, chemicals, salt, food acids and humidity.
- Posts and traverses are made of a revolutionary, extremely strong composite material with a smooth, easy to clean surface. Stronger than common wire shelving and lighter in weight than Camshelving Premium Series. Traverse dovetails are separate from the posts and attach easily to secure the shelf traverses.
- Premium caster is made of highly durable, non-corrosive plastic with a 5" (12,7 cm) swivel, non-marking thermoplastic rubber wheel. Total locking brake locks both swivel motion and the wheel.
- Optional donut bumper offers added protection during transport and when maneuvering mobile units into place against walls or alongside other units for storage.
- Smooth polypropylene shelf plates contain Camguard, an antimicrobial technology that inhibits the growth of mold, fungus and bacteria that may cause odors, stains and product degradation.
- Posts and traverses wipe clean. Traverses and shelf plates remove easily for cleaning.
- Shelf traverses can be removed and adjusted at 4" (10,2 cm) increments.
- Requires some assembly with minimal parts. Use a rubber mallet only.
- Lifetime warranty against rust and corrosion (posts, traverses and shelf plates).
- Available in 1 color – Speckled Gray (480).

Project \_\_\_\_\_

Item No. \_\_\_\_\_

Model No. \_\_\_\_\_

Quantity \_\_\_\_\_



Mobile Starter Unit with 4 Vented Shelves



Mobile Starter Unit with 5 Vented Shelves

## WEIGHT BEARING CAPACITY

Weight must be evenly distributed across the entire shelf.

		UNIT LENGTH 36" – 60"
<b>MOBILE UNIT</b>	Unit only*	750 lbs.

\* Due to the weight bearing capacity of casters, maximum weight load on an entire Mobile Unit is 750 lbs. (340 kg).

### Approvals



Post Connectors, Corner Connectors, Floor Fastener, Wall Fastener, Identification Tags, Shelf Rails, Single Shelf Security Cage, Peg Board and Shelf Divider Bars are not NSF listed.



Information and specifications are subject to change without notice. Please confirm at time of order.

Telephone: (714) 848-1555 Toll Free: (800) 854-7631 Customer Service: (800) 833-3003

© Cambro Manufacturing Company Huntington Beach, California 92647

Printed in U.S.A. 09/23

www.cambro.com

# Camshelving® Elements XTRA Series

## Mobile Starter Units 4 or 5 Vented Shelves

**70 1/4"**  
HEIGHT

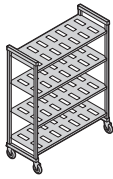

**18"**  
DEPTH

**21"**  
DEPTH

**24"**  
DEPTH

**78 1/4"**  
HEIGHT

**18"**  
DEPTH

**21"**  
DEPTH

**24"**  
DEPTH

### V4 4-Shelf Vented Mobile Units

CODE	DIMENSIONS D x L x H*
EXMU183670V4	18" x 36" x 70 1/4"
EXMU184270V4	18" x 42" x 70 1/4"
EXMU184870V4	18" x 48" x 70 1/4"
EXMU185470V4	18" x 54" x 70 1/4"
EXMU186070V4	18" x 60" x 70 1/4"
EXMU213670V4	21" x 36" x 70 1/4"
EXMU214270V4	21" x 42" x 70 1/4"
EXMU214870V4	21" x 48" x 70 1/4"
EXMU215470V4	21" x 54" x 70 1/4"
EXMU216070V4	21" x 60" x 70 1/4"
EXMU243670V4	24" x 36" x 70 1/4"
EXMU244270V4	24" x 42" x 70 1/4"
EXMU244870V4	24" x 48" x 70 1/4"
EXMU245470V4	24" x 54" x 70 1/4"
EXMU246070V4	24" x 60" x 70 1/4"

CODE	DIMENSIONS D x L x H*
EXMU183678V4	18" x 36" x 78 1/4"
EXMU184278V4	18" x 42" x 78 1/4"
EXMU184878V4	18" x 48" x 78 1/4"
EXMU185478V4	18" x 54" x 78 1/4"
EXMU186078V4	18" x 60" x 78 1/4"
EXMU213678V4	21" x 36" x 78 1/4"
EXMU214278V4	21" x 42" x 78 1/4"
EXMU214878V4	21" x 48" x 78 1/4"
EXMU215478V4	21" x 54" x 78 1/4"
EXMU216078V4	21" x 60" x 78 1/4"
EXMU243678V4	24" x 36" x 78 1/4"
EXMU244278V4	24" x 42" x 78 1/4"
EXMU244878V4	24" x 48" x 78 1/4"
EXMU245478V4	24" x 54" x 78 1/4"
EXMU246078V4	24" x 60" x 78 1/4"

Color: Speckled Gray (480).  
\*Includes 127 mm casters.

Project \_\_\_\_\_

Item No. \_\_\_\_\_

Model No. \_\_\_\_\_

Quantity \_\_\_\_\_

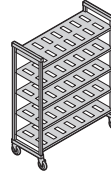

**18"**  
DEPTH

**21"**  
DEPTH

**24"**  
DEPTH

**18"**  
DEPTH

**21"**  
DEPTH

**24"**  
DEPTH

### V5 5-Shelf Vented Mobile Units

CODE	DIMENSIONS D x L x H*
EXMU183670V5	18" x 36" x 70 1/4"
EXMU184270V5	18" x 42" x 70 1/4"
EXMU184870V5	18" x 48" x 70 1/4"
EXMU185470V5	18" x 54" x 70 1/4"
EXMU186070V5	18" x 60" x 70 1/4"
EXMU213670V5	21" x 36" x 70 1/4"
EXMU214270V5	21" x 42" x 70 1/4"
EXMU214870V5	21" x 48" x 70 1/4"
EXMU215470V5	21" x 54" x 70 1/4"
EXMU216070V5	21" x 60" x 70 1/4"
EXMU243670V5	24" x 36" x 70 1/4"
EXMU244270V5	24" x 42" x 70 1/4"
EXMU244870V5	24" x 48" x 70 1/4"
EXMU245470V5	24" x 54" x 70 1/4"
EXMU246070V5	24" x 60" x 70 1/4"

CODE	DIMENSIONS D x L x H*
EXMU183678V5	18" x 36" x 78 1/4"
EXMU184278V5	18" x 42" x 78 1/4"
EXMU184878V5	18" x 48" x 78 1/4"
EXMU185478V5	18" x 54" x 78 1/4"
EXMU186078V5	18" x 60" x 78 1/4"
EXMU213678V5	21" x 36" x 78 1/4"
EXMU214278V5	21" x 42" x 78 1/4"
EXMU214878V5	21" x 48" x 78 1/4"
EXMU215478V5	21" x 54" x 78 1/4"
EXMU216078V5	21" x 60" x 78 1/4"
EXMU243678V5	24" x 36" x 78 1/4"
EXMU244278V5	24" x 42" x 78 1/4"
EXMU244878V5	24" x 48" x 78 1/4"
EXMU245478V5	24" x 54" x 78 1/4"
EXMU246078V5	24" x 60" x 78 1/4"

### Optional Accessories

- Shelf Identification Tags
- Shelf Divider Panel
- Shelf Divider Bars (Straight or Angled)
- Shelf Rails
- Single Shelf Security Cage
- Shelf Traverses (Single or Double)
- Drying and Storage Cradles
- Universal Storage Rack
- Peg Board

### Architect Specs

Posts and Traverses: Proprietary non-corrosive composite material.  
Post Connectors: Reinforced polypropylene.  
Shelf Plates: Reinforced polypropylene with Camguard® antimicrobial.  
Caster: Non-corrosive plastic body and brake with non-marking thermoplastic rubber wheel.  
Traverse Dovetails: Reinforced nylon.  
Post Connector Collar Wedge: Reinforced nylon.

### Approvals



Post Connectors, Corner Connectors, Floor Fastener, Wall Fastener, Identification Tags, Shelf Rails, Single Shelf Security Cage, Peg Board and Shelf Divider Bars are not NSF listed.



www.cambro.com

Information and specifications are subject to change without notice. Please confirm at time of order.

Telephone: (714) 848-1555 Toll Free: (800) 854-7631 Customer Service: (800) 833-3003

© Cambro Manufacturing Company Huntington Beach, California 92647

Printed in U.S.A. 09/23

EXCS8

0082307

# Camshelving® Elements XTRA Series

## Undercounter Units 2 Vented Shelves Mobile and Stationary

HEIGHTS	DEPTHS	LENGTHS
2	2	3
27¼"	14"	24"
30"	18"	36"
		48"

- **Stationary Units include:**  
2 factory assembled stationary post kits, 4 traverses, traverse dovetails and shelf plates.
- **Mobile Units include:**  
2 factory assembled mobile post kits, 4 traverses, traverse dovetails, shelf plates and 4 premium swivel casters with total locking brake.

All units ship complete in 1 box.

### Features & Benefits

- Designed to easily support the performance demands of a busy foodservice operation with medium to heavy storage needs.
- Designed to nest underneath standard height tables and counters. Withstands storage temperatures -36° to 190°F (-38° to 88°C). Impervious to moisture, chemicals, salt, food acids and humidity.
- Posts and traverses are made of a revolutionary, extremely strong composite material. Stronger than common wire shelving and lighter in weight than Camshelving Premium Series. Traverse dovetails attach easily to secure shelf traverses.
- Smooth polypropylene shelf plates contain Camguard, an antimicrobial technology that inhibits the growth of mold, fungus and bacteria that may cause odors, stains and product degradation.
- Posts and traverses wipe clean. Traverses and shelf plates remove easily for cleaning.
- Shelf traverses can be removed and adjusted at 4" (10,2 cm) increments.
- Sturdy reinforced nylon foot adjusts easily to level units.
- Premium caster is made of highly durable, non-corrosive plastic with a 5" (12,7 cm) swivel, non-marking thermoplastic rubber wheel. Total locking brake locks both swivel motion and the wheel.
- Requires some assembly with minimal parts. Use a rubber mallet only.
- Lifetime warranty against rust and corrosion (posts, traverses and shelf plates).
- Available in 1 color – Speckled Gray (480).

Project \_\_\_\_\_

Item No. \_\_\_\_\_

Model No. \_\_\_\_\_

Quantity \_\_\_\_\_



Mobile Undercounter Unit



Stationary Undercounter Unit

## ELEMENTS SERIES WEIGHT BEARING CAPACITY

Weight must be evenly distributed across the entire shelf.

		UNIT LENGTH 24" – 48"
MOBILE UNIT	Unit only	200 lbs.
	Shelf only	100
STATIONARY UNIT	Unit only	200
	Shelf only	100

### Approvals



Post Connectors, Corner Connectors, Floor Fastener, Wall Fastener, Identification Tags, Shelf Rails, Single Shelf Security Cage, Peg Board and Shelf Divider Bars are not NSF listed.



www.cambro.com

Information and specifications are subject to change without notice. Please confirm at time of order.

Telephone: (714) 848-1555 Toll Free: (800) 854-7631 Customer Service: (800) 833-3003

© Cambro Manufacturing Company Huntington Beach, California 92647

Printed in U.S.A. 09/23

D082307

# Camshelving® Elements XTRA Series

Undercounter Units 2 Vented Shelves Mobile and Stationary

Project \_\_\_\_\_

Item No. \_\_\_\_\_

Model No. \_\_\_\_\_

Quantity \_\_\_\_\_

## V2 2 Shelf Mobile Units

**27¼"**  
HEIGHT

**14"**  
DEPTH

CODE	DIMENSIONS D x L
EXMU142427V2	14" x 24"
EXMU143627V2	14" x 36"
EXMU144827V2	14" x 48"

Color: Speckled Gray (480).

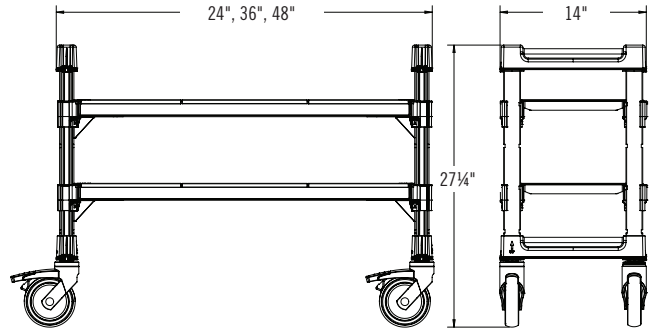

## V2 2 Shelf Stationary Units

**30"**  
HEIGHT

**18"**  
DEPTH

CODE	DIMENSIONS D x L
EXU183630V2	18" x 36"
EXU184830V2	18" x 48"

Color: Speckled Gray (480).

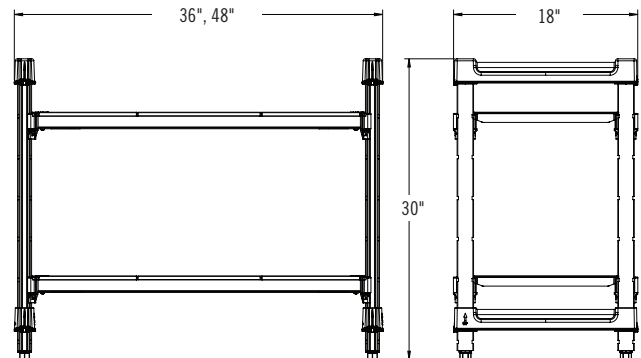

### Optional Accessories

- Bottom Shelf Dunnage Stands (Low or Tall)
- Shelf Identification Tags
- Wall Fastener
- Seismic Foot
- Shelf Divider Panel (18" Deep Only)
- Shelf Rails

### Architect Specs

Posts and Traverses: Proprietary non-corrosive composite material.  
 Post Connectors: Reinforced Polypropylene.  
 Shelf Plates: Reinforced polypropylene with Camguard® antimicrobial.  
 Adjustable Foot: Reinforced nylon.  
 Traverse Dovetails: Reinforced nylon.  
 Post Connector Collar Wedges: Reinforced nylon.  
 Caster: Non-corrosive plastic body and brake with non-marking thermoplastic rubber wheel.

### Approvals



Post Connectors, Corner Connectors, Floor Fastener, Wall Fastener, Identification Tags, Shelf Rails, Single Shelf Security Cage, Peg Board and Shelf Divider Bars are not NSF listed.

**CAMBRO®**

www.cambro.com

Information and specifications are subject to change without notice. Please confirm at time of order.

Telephone: (714) 848-1555 Toll Free: (800) 854-7631 Customer Service: (800) 833-3003

© Cambro Manufacturing Company Huntington Beach, California 92647

Printed in U.S.A. 09/23

**EXCS9**

D082307



# Camshelving® Ultimate #10 Can Rack

## Premium Series Full-Size Rack

## Elements XTRA Series Full-Size Rack

HEIGHT	DEPTH	LENGTH
1	1	1
72"	24"	36"

\* Standard shelving depth. Actual assembled unit depth is 25.9" (65,8 cm).

- **Units include:** 1 or 2 factory assembled stationary post kits, 9 each traverses, 15 each can rack panels and 72 each can rack brackets (12 bags of 6 each). Ships knockdown, complete in 1 carton.



### Features & Benefits

- Easy to assemble, stationary can storage units with patented front loading, gravity fed rack component system that supports proper FIFO inventory management.
- Ideal for schools, colleges/universities, hospitals and any foodservice operation with high volume can usage/storage requirements. Install free standing units or share posts with other units to maximize space when combined with other units along a wall.
- Unique, can storage racks install directly onto 3 traverses – 2 front and 1 back. Side panels and brackets snap together. Connect and create 4 rows of can storage per level / tier.
- Store 8 each #10 cans or 12 each #5 cans per individual racks.
- Store 32 each #10 cans or 48 each #5 cans per level / tier.
- Can rack panels and brackets are made of highly durable plastic material that will never dent or bend with use. Once assembled and placed onto traverses, racks remain securely in place even with constant loading and removal of cans.
- Premium Series posts and traverses have a steel core and smooth polypropylene exterior for superior strength and durability. Traverse dovetails are molded into posts.
- Elements XTRA Series posts and traverses are made of extremely strong composite and plastic materials. Traverse dovetails must be installed onto the posts.
- Uniquely engineered Post Connectors offer exceptional cross stabilization. Weight bearing is uncompromised.
- Post and traverses easily wipe clean. Traverses, can rack panels and brackets can be removed and cleaned in the dishwasher.
- Requires minimal assembly. Use a rubber mallet only to install traverses.
- Lifetime warranty against rust and corrosion (posts, traverses, can rack panels and brackets).

Project \_\_\_\_\_

Item No. \_\_\_\_\_

Model No. \_\_\_\_\_

Quantity \_\_\_\_\_



**CPU243672C96**  
Premium Unit (with Cans)

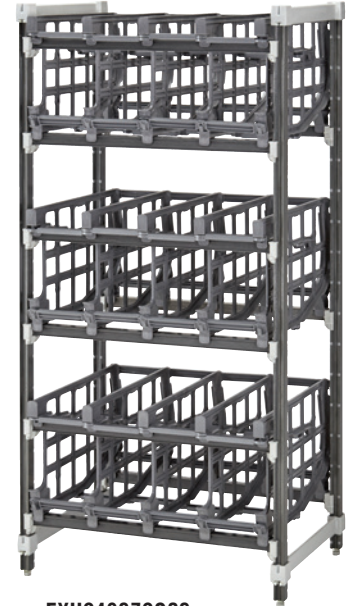

**EXU243672C96**  
Elements XTRA Unit (Empty)

### Holding Capacity per Unit

96 each #10 cans

144 each #5 cans

- Maximum weight bearing capacity per unit: 2000 lbs. (910 kg), evenly distributed.
- Available in 1 color: Speckled Gray (480).
- Ships knockdown.
- #10 Single and Add-on Can Racks are covered by U.S. Patent D828,145 S and D827,421 S.

### Approvals



COMPONENT

Post Connectors, Corner Connectors, Floor Fastener, Wall Fastener, Identification Tags, Shelf Rails, Single Shelf Security Cage, Peg Board and Shelf Divider Bars are not NSF listed.



Information and specifications are subject to change without notice. Please confirm at time of order.

Telephone: (714) 848-1555 Toll Free: (800) 854-7631 Customer Service: (800) 833-3003

© Cambro Manufacturing Company Huntington Beach, California 92647

Printed in U.S.A. 09/23

www.cambro.com



# Camshelving® Ultimate #10 Can Rack

Premium Series Full-Size Rack

Elements XTRA Series Full-Size Rack

Project \_\_\_\_\_

Item No. \_\_\_\_\_

Model No. \_\_\_\_\_

Quantity \_\_\_\_\_

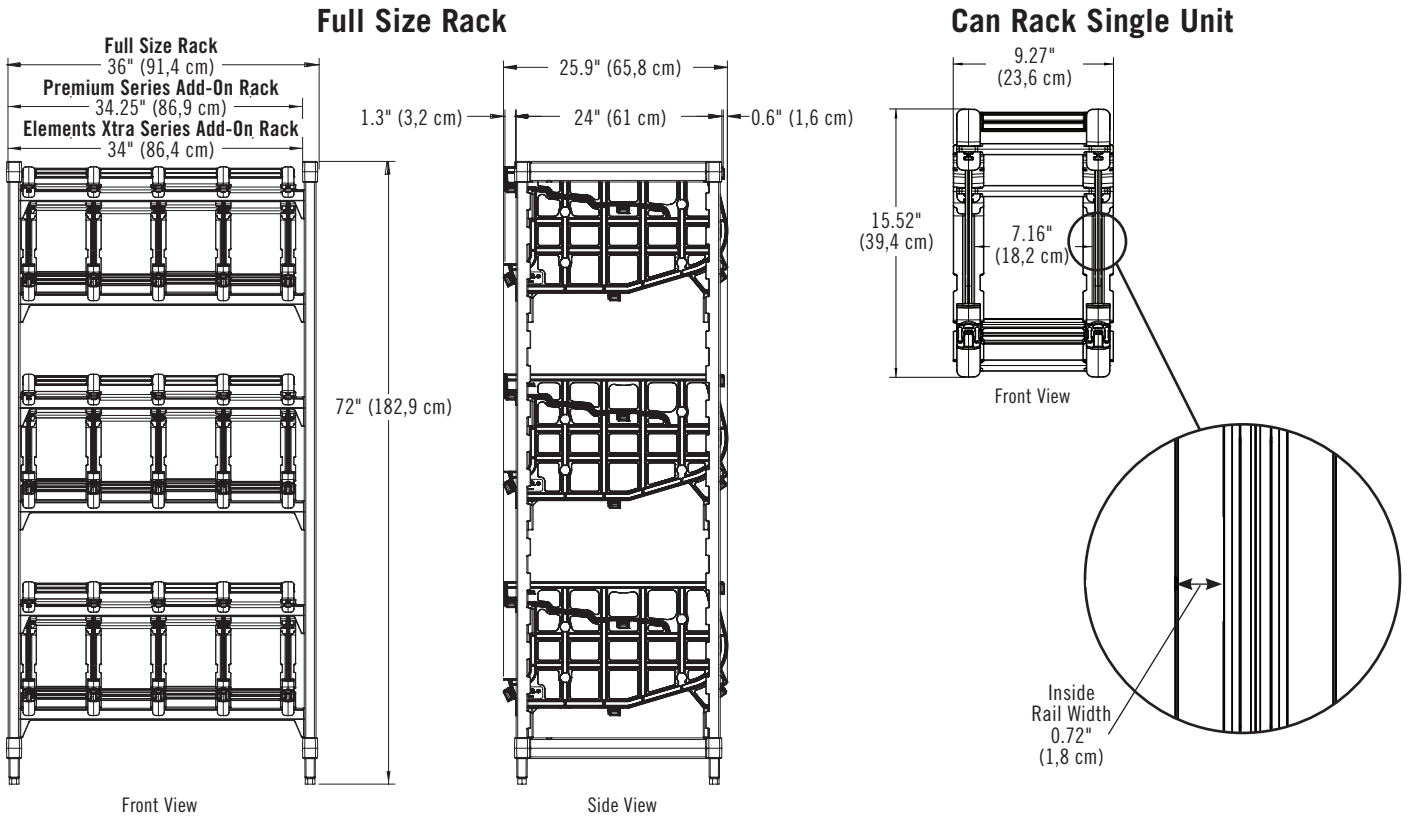

## Specifications

Code	Description	Dimensions D x L x H	Unit Weight lbs. / kg
<b>Premium Series</b>			
CPU243672C96	Full-Size Starter Unit Rack	25.9" x 36" x 72" (65,8 x 91,4 x 182,9 cm)	107.1 (48,7)
CPA243672C96	Full-Size Add-on Unit Rack	25.9" x 34.25" x 72" (65,8 x 86,9 x 182,9 cm)	91.4 (41,6)
<b>Elements XTRA Series</b>			
EXU243672C96	Full-Size Starter Unit Rack	25.9" x 36" x 72" (65,8 x 91,4 x 182,9 cm)	85.3 (38,7)
EXA243672C96	Full-Size Add-on Unit Rack	25.9" x 34" x 72" (65,8 x 86,4 x 182,9 cm)	74.3 (33,7)

Color: Speckled Gray (480).

## Architect Specs

### Post and Traverses:

Premium Series: Internal steel core, reinforced polypropylene exterior

Elements XTRA Series: Proprietary non-corrosive composite material

Post Connectors: Reinforced polypropylene

Can Rack Panel and Bracket: Reinforced nylon

Post Connector Collar Wedges: Reinforced nylon (Elements XTRA Series Only)

Traverse Dovetails: Reinforced nylon (Elements XTRA Series Only)

## Optional Accessories

- Wall Fastener
- Floor Fastener
- Dunnage Stand

## Approvals



COMPONENT

Post Connectors, Corner Connectors, Floor Fastener, Wall Fastener, Identification Tags, Shelf Rails, Single Shelf Security Cage, Peg Board and Shelf Divider Bars are not NSF listed.

# CAMBRO®

www.cambro.com

Information and specifications are subject to change without notice. Please confirm at time of order.

Telephone: (714) 848-1555 Toll Free: (800) 854-7631 Customer Service: (800) 833-3003

© Cambro Manufacturing Company Huntington Beach, California 92647

Printed in U.S.A. 09/23

EXCS10

D082307