



SHELVING SOLUTIONS



Profit from the Eagle Advantage[®]

PHONE 800-441-8440 • 302-653-3000 • FAX 302-653-2065 • www.eaglegrp.com



STRONGEST IN THE INDUSTRY!



patented
QuadTruss®
design
(Patent #5,390,803)

EAGLE Wire Shelving

EAGLEgard® WIRE SHELVING NOW FEATURES MICROGARD®

An antimicrobial agent which contains built-in protection to retard the growth of a broad range of bacteria, mold and mildew on the surface of the shelves that cause stains, odors and degradation.



Easy Assembly...

Numerically calibrated grooved posts, tapered plastic split sleeves and shelf collars combine to make shelving assembly a simple **TWO STEP PROCESS**:



- 1) Snap the split sleeves onto the post over the number of your choice.
- 2) Slide the shelf collars over the split sleeves. A positive lock between shelf and post is created *without the use of any tools*.

Tapered split sleeves of high-temperature-resistant ABS plastic create a positive lock that becomes stronger as the load increases.

Posts are numbered in 1" increments to ensure fast and level assembly.



Leveling feet are provided to help compensate for uneven floor surfaces.

Available in six finishes:

EAGLEbrite® sealed with MasterSeal® coating for improved rust protection, chrome plating, VALU-MASTER® pewter grey epoxy, Valu-Gard® green epoxy, EAGLEgard® with MICROGARD® antimicrobial protection, heavy duty translucent green epoxy finish (also with MasterSeal® coating), and stainless steel.

SHELF AND POST FINISHES AVAILABLE

Stainless Steel Finish—OUR BEST!

Stainless Steel

- NSF-listed for all environments.
- Type 304 stainless steel.

NOTE: Stainless steel shelving is electropolished.

**15-YEAR
LIMITED
WARRANTY**

EAGLEgard® Hybrid Epoxy

Zinc Chloride

Clear Chromate

MasterSeal® Sealer

Blue Green (translucent)

- hybrid epoxy with MICROGARD®

- NSF-listed for all environments.
- Zinc chloride plating followed by clear chromate plating with MasterSeal® Sealer and a hybrid epoxy final coat.

**12-YEAR
LIMITED
WARRANTY**

Valu-Gard® Green Epoxy

Phosphate Conversion Coating

MasterSeal® Sealer

Green (opaque)

- hybrid metallic epoxy

- NSF-listed for wet or dry storage environments.
- Phosphate conversion coating followed by green hybrid epoxy coating.

**5-YEAR
LIMITED
WARRANTY**

VALU-MASTER® Grey Epoxy

Phosphate Conversion Coating

MasterSeal® Sealer

Pewter Gray Epoxy

- NSF-listed for wet or dry storage environments.
- Phosphate conversion coating followed by metallic gray epoxy coating.

**5-YEAR
LIMITED
WARRANTY**

Chrome Finish

Bright Nickel

Chrome

Air-dry Lacquer

- NSF-listed for dry storage environments.
- Bright nickel plating followed by chrome plating.

NOTE: Optional clear hybrid epoxy, NSF-listed for all environments, is available.

**1-YEAR
LIMITED
WARRANTY**

EAGLEbrite® Zinc

Zinc chloride

Clear Chromate

MasterSeal® Sealer

- NSF-listed for dry storage environments.
- Bright zinc chloride plating followed by clear chromate plating with MasterSeal® sealer for improved rust protection.

NOTE: Wire shelves feature MasterSeal® Sealer. NSF-listed for all environments.

**3-YEAR
LIMITED
WARRANTY**

QuadPLUS® Polymer Shelf Mats with Wire Truss Frames

NSF

Mats come with choice of...

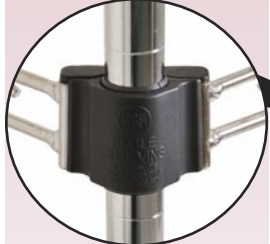

Quad-Adjust® Truss Frame...
Allows the addition or removal of a shelf without having to disassemble the entire shelving unit.



...or Standard Wire Truss Frame



blue shelf mats—louvered and solid
—shown assembled as shelving unit

Blue or green polymer shelf mats available!

Mats snap in place!



removable shelf mats shown with Quad-Adjust® wire truss frame



green louvered shelf mats shown assembled as shelving unit

Easy Assembly! No tools needed!

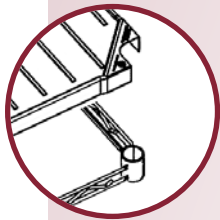

Step 1
Position polymer mats onto wire truss frame accordingly.

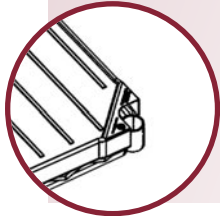

Step 2
Gently push each mat down along the front and rear to snap them into place.

Easy to clean!



- Mats snap into truss frame.
- Injection-molded polypropylene mats feature MICROGARD® antimicrobial protection.
- Easy cleaning.
- Dishwasher-safe.
- Blue mats come with truss frames coated with chrome or Valu-Master® gray epoxy finish.
- Green mats come with truss frames coated with EAGLEgard® epoxy or Valu-Gard® epoxy finish.
- Both style of truss frames can be fitted onto the same shelving unit.
- Set of four split sleeves (included with each truss frame) snap onto Eagle's 1"-diameter posts.
- Temperature rating of shelf mats: -20°F to 125°F.

louvered shelf mat

solid shelf mat

MICROGARD®

is an antimicrobial agent which contains built-in protection to retard the growth of a broad range of bacteria, mold and mildew on shelf surface that causes stains, odors and degradation.

Standard on all QuadPLUS®

QUAD-ADJUST® WIRE SHELVING

NSF

PATENTED!

(Patent #7,992,731)

Add to your existing shelving without having to disassemble the entire unit.

- Shelves feature special interlocking corners that fit in slots of collars mounted to split sleeves, allowing addition or removal of a shelf without the need to disassemble the entire shelf unit.
- Tapered split sleeves create a positive lock that becomes stronger as the load increases.
- Leveling feet are provided to help compensate for uneven floor surfaces.
- Shelf utilizes a pincer-type design with the mat wire sandwiched between the two top truss wires, adding significant strength and distributing the entire load without stress and strain on the welds.
- Available in standard finishes.
- Accommodates standard wire shelving accessories.



channel of shelf corner fits into slot of collar attached to split sleeve

Assembly is a simple 3-step exercise:

Step 1

Snap the split sleeves onto a post over the number of your choice.

Step 2

Attach the Quad-Adjust® slotted collar onto the split sleeves.

Step 3

Slide shelf into slotted collar to complete.

patented
QuadTruss®
design
(Patent #5,390,803)

make it Your Shelf!™

Make it easy for your customers to buy shelving with EAGLE GROUP's...

...SELF-SERVE SHELVING DISPLAY

*Includes everything your customer needs with easy step-by-step instructions. **Best of all, the unit is FREE when you order the shelving to stock the display unit.***

Call today for more information.

1-800-441-8440



(Dimensions: 59"W x 25½"D x 78½"H)

Shelving

Security Units, Solid Shelving, and Dunnage Racks



Security Modules NSF

- Converts portion of shelf unit into a lockable enclosed security unit, adding versatility and flexibility.
- Includes end panels, rear panel, and door(s).
- Available with hinged doors or with single flip-up door.
- Fits in between two wire shelves spaced 20" apart.
- More than one module can be added, depending on unit's overall height.
- Available for 18", 21", and 24" wide shelving units.



Security Units NSF

Ideal for safely storing and transporting costly materials and items subject to pilferage.

- Heavy-gauge open-wire construction keeps contents visible for quick inventory checks.
- Variety of sizes are available in stationary models or with casters for easy mobility.
- Quick-action locking feature with hasp for padlock.
- All units feature full-access double doors swinging out at approximately 270°.
- Plated finishes include EAGLEbrite® zinc, EAGLEgard® green epoxy with MICROGARD®, stainless steel or chrome for a durable easy-to-clean finish.



Solid Shelving NSF

- Available in 18 gauge type 304 stainless steel or 18 gauge VALU-MASTER® gray epoxy coated galvanized steel.
- Shelves feature aluminum castings which utilize split sleeves.
- Shelves can be adjusted in 1" increments, allowing you to update your shelving as often as you update your stock.
- Shelving remains accessible from all sides, while leveling feet help compensate for uneven flooring surfaces.



**1,000 LBS.
EVENLY DISTRIBUTED
WEIGHT CAPACITY
PER SHELF!!**

Quik-Set® Heavy Duty Solid Shelving NSF

Designed specifically for heavy-duty load-bearing capacity.

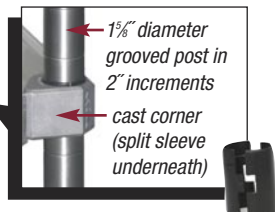

- Constructed of either 14 or 16 gauge type 300 stainless steel or galvanized steel coated with VALU-MASTER® gray epoxy.
- All sides of shelves are constructed with a 2" downturn and marine edge.
- Posts features an adjustable foot or is fitted for optional 5" diameter caster.
- **No tools required for assembly.**

**ALSO AVAILABLE:
Embossed and Louvered.**

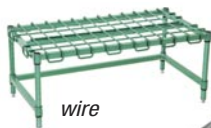

wire



aluminum

Dunnage Racks NSF

- All racks provide elevated storage space for excessive loads.
- Available in lengths up to 60".



*Also Available:
Polymer Dunnage Racks*

**Please refer to the Price List
for information on optional accessories.**

Q-LEVER® Heavy Duty Cantilever Shelving Systems

- Maximizes storage, freestanding shelving allows access to all corners.
- With no front uprights, accessibility and productivity are greatly improved.
- Uprights utilize 2" adjustment for shelf and accessory spacing.
- Shelves and accessories can be easily adjusted without the need for tools.
- Can be expanded side-to-side with Add-On units, which share a common upright with existing unit, saving cost and space.
- Units allow for sheet metal or wire overlays.
- Offered in 18" to 30" shelf widths and 24" to 72" shelf lengths.



PATENTED!
(Patent #10,159,339)

Four-Tier Starter and Add-On Units

Master Trak® Overhead Track High-Density Storage System

- Maximum storage in a minimum amount of space.
- Requires only single-aisle access.
- Allows longer track length without a stationary intermediate unit.
- Quick and easy assembly.
- Offered in a wide selection of sizes, with shelves ranging from 18" to 36" wide and 24" to 72" long, and overhead track ranging from 6' to 21' long.



Now patented, unique roller assembly provide smooth operation without binding, which can occur in other track systems.
Patent #5,680,942

Floor-Trak® High-Density Storage Systems

- Industrial-type bearings allow loaded units to glide effortlessly over track.
- Low profile, non-corrosive track constructed of stainless steel and anodized aluminum.
- Consolidates space.
- ADA-compliant.
- Simple and easy to install.
- Can be built double deep and not impede rollability.
- Easy to add-on additional tracks and units.
- Open construction allows for the use of cart covers, when required.
- Optional shim kit and foot brake kit available.



Add-A-Shelf® Adjustable Shelving Systems

EAGLE GROUP's Add-A-Shelf® allows you to add or remove a shelf without having to disassemble the entire unit. Reconfigure shelving in seconds. Five standard finishes available—zinc, chrome, black, white, or red epoxy—along with many custom colors. A variety of sizes and reverse mat shelves which provide a retaining ledge are available.



Add-A-Shelf® unit



Add-A-Shelf® with EAGLE GROUP's security unit...



...or use as a merchandise display unit



ALLOWS FOR FREEDOM TO POSITION THE SHELF ANYWHERE ON THE BRACKETS WITHOUT THE USE OF FASTENERS.

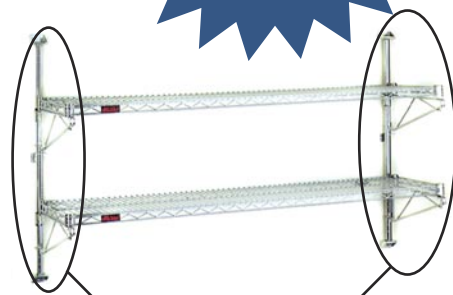

adjustable post wire wall mounts (end units shown)

Wall Mounted Shelving

Piggyback Wall Mounted Shelf Kits

- Chrome finish.
- Brackets can be mounted to studs – no wall backing required.
- Three or five tier kits available.
- Freedom to move the shelves left or right.
- Wire design allows for air circulation.
- Available in 18" width.
- Shelf lengths available range from 24" to 60".
- **No tools required to attach shelf to wall brackets.**

PATENTED!
(Patent #8,025,163 B2)

Wall Mounted Shelving

- Post wall mounts are ideal where floor space is limited, maximizing storage capacity and minimizing clutter. Especially convenient for mounting over work surfaces.
- Adjustable shelving components are designed to allow the intermixing of shelf widths or customizing of units to fit every specification need.
- Stationary wall mounts are designed and offered complete with mounting brackets, engineered for fixed applications where vertical adjustments are not required.



stationary wire wall mounts



Wire or Solid Snap-n-Slide®

- Wire brackets can be mounted to studs – no wall backing required.
- Upturn on rear of shelf and downturn on front of shelf.
- Heavy gauge wire construction.

Cantilevered Shelving Systems

Designed for Walk-In Coolers, Environmental Rooms and More...



- Adaptable for all areas where storage is needed.
- 100% usable shelving surface, from section to section, wall to wall, and front to back. There are no posts to restrict stock placement. Floor is unobstructed.
- Infinite height adjustability, no slots or keyholes to line up for leveling. Shimming is eliminated.
- Wall-mounted shelving requires no support from the floor. Floor area is therefore open and easily maintained.
- For use with both standard wire and solid shelving.
- All components are made of heavy gauge material and available in gray epoxy, aluminum and stainless steel.
- Heavy-duty, rugged construction.

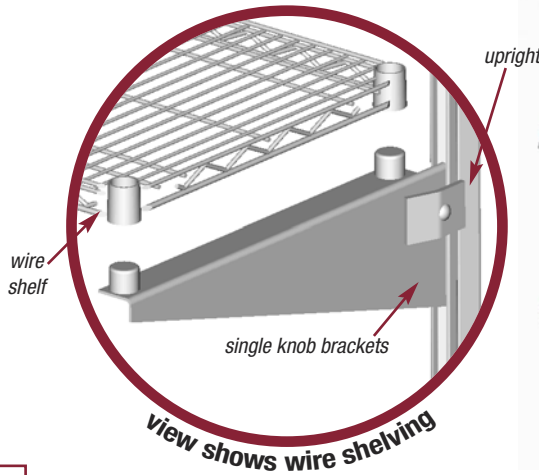

WALSTOR® Wall Systems

When Space Is Driving You Up the Wall

- WALSTOR® Shelving Systems give you the maximum efficiency in storage solutions by putting the “wide open spaces” of your walls to work. Utilizing previously unused wall area for storage, prep or additional work areas.
- When mounted to wall studs, the bracket system allows shelves to be placed off-center while remaining locked into place.
- WALSTOR® is sway resistant shelving for heavier load ratings.
- Available in EAGLEbrite® zinc finish.
- Keep everything within easy reach, without taking up valuable floor space.
- WALSTOR® allows you to efficiently organize your room with total flexibility.

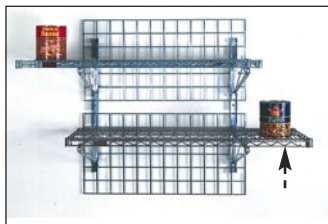

unequal load capability



adjuSTable® Work Surface Systems

NSF

'Customize Your Work Surface'



1-tier unit



basic unit



2-tier unit

Allows you to create work surfaces of your choice with single or multiple cantilevered overhead or wire overshelf systems.

A stainless steel tabletop/work surface, unsurpassed in the industry for quality. The four chrome posts are numbered in 1" increments for flexible and level positioning of the two chrome wire undershelves.

Create an unlimited number of custom configurations by adding additional wire or solid stainless steel undershelves, H-frame or C-frame, chrome wire overshelves or solid stainless steel overshelves.

A variety of options available including utility drawers, cantilever shelves, reel holders, bench power centers, bin holders, and dividers allow for complete customization to fit your needs.



electronics workstation

Various Configurations of adjuSTable® Available

EAGLE GROUP workstations are flexible and can be adapted when field conditions change. An unlimited number of configurations are available to fit your unique requirements, and even more configurations can be created utilizing accessories and options.



Wire Basket Shelving

Perfect for light duty applications where easy accessibility of products is required.

- Chrome plated finish with 3 lengths available; 24", 36" and 48".
- For use with standard shelving posts.
- Basket shelves can also be used in mobile applications such as utility carts, or on Floor-Trak® high-density storage systems.
- Open wire construction permits greater air circulation which helps reduce moisture and dust build-up.

Mobile Shelving Systems



Stem Caster Carts and Dolly Trucks ^{NSF}

- Our patented Quad-Truss[®] design (Patent #5,390,803) makes shelves up to 25% stronger, providing you with the strongest carts in the industry.
- Sturdy, mobile four shelf unit available in either mirror chrome or EAGLEbrite[®] zinc finish.
- Dolly truck comes with complete wraparound bumper.



Angled Shelf Carts ^{NSF}

Increase product visibility of quick-moving merchandise.

- Unit allows you to adjust and re-adjust shelf heights and angle variances.
- Sturdy, mobile four-shelf unit available in either mirror chrome, VALU-MASTER[®] gray epoxy, EAGLEbrite[®] zinc finish or black.



also available:
three wire shelves, or
two wire and one solid shelf.

Utility Carts ^{NSF}

- Patented Quad-Truss[®] design (Patent #5,390,803) makes our shelves up to 25% stronger and provides a retaining ledge for increased storage stability and product retention.
- Finishes offered are mirror chrome or EAGLEbrite[®] zinc finish.

Benchside Tote Box Carriers

Ergonomically designed for repetitive pick-and-pack activity.

- Features angled shelf with built-in ledge and flat undershelf.
- 5" diameter resilient casters – two with brake.
- Offered in lengths ranging from 24" to 60".



Tote Box Carriers

Accommodates a wide variety of containers.

- Each tote box carrier comes with two brake and two swivel casters.
- One-, two-, or three-bay carrier models available with standard resilient or poly casters.

Double-Sided Bin-Holder Carts

- Carts consist of four bin-holder rails and four 63" posts with casters.
- Posts are numbered in increments of 1" to ensure fast and level assembly.
- EAGLEbrite[®] zinc or chrome plated.
- Bins can be attached to both sides of rail - no tools required.
- Bin-holder rails are sold as an accessory or can be purchased with posts as a kit.



EAGLE GROUP offers hundreds of differently configured mobile shelving systems for virtually any application. Carts can be altered to meet changing requirements. By adding or removing accessories, any number of combinations can be made to customize any cart for a specific use. The open-wire construction promotes higher visibility by allowing light to pass through the shelves, permits greater air circulation reducing dust and contamination buildup, and increases the effectiveness of fire-suppression systems.



Wire Freestanding Gowning Racks

- These racks incorporate standard wire shelving components with specially designed gown storage options.
- They offer a more economical rack option in less demanding environments.
- Racks available in chrome or electropolished stainless steel.

Wire Wall Mounted Gowning Racks



- Models with hanger slots, hanger tube, or hook rack available.
- All racks feature standard wire shelf and wall mount brackets.
- Available in chrome or electropolished stainless steel.

Shoe Racks

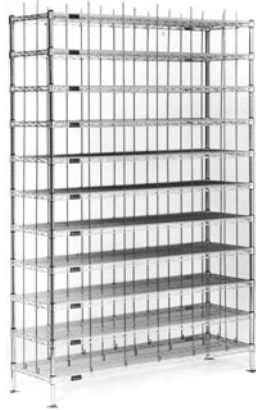

- Wire shelves offer the optimum combination of laminar flow and ventilation for the storage of cleanroom shoes.
- Rods & tabs run through shelves to create cubbies for each pair of shoes.
- Available finishes are chrome and electropolished stainless steel.

Perforated Gowning Benches

- Perforated solid top with wire undershelf provides superior laminar flow.
- Wire undershelves offer optional bootie storage.
- Optional dividers and additional wire shelves.
- Available in No. 4 brushed or electropolished finish.



Roll Bag Dispensers



- Standard unit features two 14" x 48" wire shelves, one 3-sided channel frame, eight removable dispensing bars, and four post with 30" outrigger feet.
- Dispenser bars are adjustable on 1" increments.
- Available in stainless steel or chrome finish.

EAGLE GROUP's cleanroom line offers wire shelving with superior strength - while at the same time allowing for 62% laminar flow. EAGLE GROUP offers the preferred transport and storage vehicle by providing numerous ergonomic and visual advantages, and does not hold particulation. Numerous options allow customization for any environment or situation. The open-wire construction promotes higher visibility by allowing light to pass through the shelves, permits greater air circulation reducing dust and contamination buildup, and increases the effectiveness of fire-suppression systems.

Electronics Applications



Electronic Tray Carts

Offers a practical and economical method of transporting or storing conductive trays.

- These knock-down units feature zinc-plated wire shelves, chrome posts and aluminum split sleeves.
- End-load and side-load available in half or full size and all models roll on 5" resilient swivel casters.



Vibration Dampening Tray Carts

- Provides maximum benefits in vibration transfer, ESD-safe, and cost.
- Vibration transfer is dramatically reduced via polyurethane 50 shore A casters with expander stems, 5" swivel, two with brake.
- All models feature front and rear tray locks to ensure product safety.



Gravity Flow Line Feed Carts

- Offers the ergonomic advantage of an angled shelf along with added visibility in the storage bins.
- Available for stationary or mobile applications.
- Flexibility to adjust shelves on 1" vertical increments and to adjust the slope of each shelf.



patented
QuadTruss®
design
(Patent #5,390,803)

Mobile Computer Workstations

- Patented Quad-Truss® design makes shelves up to 25% stronger and provides a retaining ledge for increased stability and product retention.
- 5" swivel casters, two with brake.
- Offered in chrome or stainless finish.
- 7" x 7" mouse tray (sold separately) is chrome-plated.



two tiers of stencil shelves shown in mobile unit configuration

Stencil Shelves

- Zinc finish, and includes one bottom and one top partitioned shelf.
- Each shelf has (15) 2" partitions.
- Stencil shelves may be used with numerous combinations of posts and casters to meet your specific needs.

Optional accessories for Electric Tray Cart and Vibration Dampening Carts

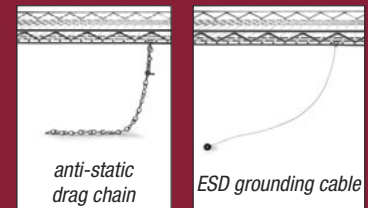

anti-static drag chain

ESD grounding cable

Please refer to the Price List for information on additional accessories.

Custom Configurations Available

Available through EAGLE GROUP's SpecFAB® Division, a division formed to fill the gap between standard equipment and high-cost, wish-and-wait for highly customized equipment. SpecFab® provide a way to short-cut the design and fabrication process. Depending on the customers needs, we can build custom configurations from scratch or design superior pre-fab pieces from existing components. This flexibility means we can deliver custom equipment faster and at a lower cost to you. For a SpecFAB® quote send all request to quotes@eaglegrp.com.



Linen Carts

- Standard models offered are equipped with four wire and one solid shelf mounted on an industry standard frame.
- Heavy-duty models offered are equipped with four wire shelves and one solid shelf mounted on a heavy-duty dolly frame, and include side and back enclosure panels.
- Carts can be altered readily to meet changing requirement by adding or removing accessories.
- Wire shelves are chrome-plated. Solid shelf is stainless steel. Posts are chrome-plated over 16 gauge stainless steel, ensuring stability in any use.

Inhalation Therapy Cart

- Constructed with the patented Quad-Truss® design (Patent #5,390,803) and chrome plating, this item conforms to NFPA 99.
- Includes four UL-recognized 5" conductive casters.
- Racks are plastic coated and accommodate twelve "D" or "E" cylinders.



Catheter Procedure Carts

- Patented Quad-Truss® design makes shelves up to 25% stronger and provides a retaining ledge for increased storage, stability and product retention.
- Carts are capable of holding all sizes and styles of catheter packages. Hooks, shelves, and tote boxes give you the versatility to create the ideal system for your requirements.
- All components are adjustable. Shelves are vertically adjustable on 1" increments, while the hook and bar assemblies can be adjusted to accommodate peel pouches 3" or greater in width. Bars are readily removable. All casters are swivel type, and feature polyurethane tread. Two casters are provided with brakes.

patented
QuadTruss®
design
(Patent #5,390,803)

Suture Carts

- Suture unit is available with four or five adjustable wire shelves, which can be adjusted up or down in 1" increments without the use of tools. Slope of shelves is also adjustable from 0° to 30° by raising or lowering front or back truss brace.
- The special self-feeding design of the slanted shelves provides quick, easy access to stored materials.
- Open-wire construction for easy identification.



Exchange Carts

- Versatile exchange carts come with various shelving configurations, caster styles and accessory packages.
- The open-wire construction promotes higher visibility and requires light assembly.
- Shelving can be adjusted up and down by 1" increments for optimum cart configuration.
- Wire shelves, dolly frames and posts have chrome plated finish.



Standouts™ Display Shelving

Creative Retail Display Concepts

Show off your merchandise when you use our wire display shelving units in various configurations highlighted by thirteen brilliant finishes plus chrome.

- Open wire grid shelf allows maximum merchandise versatility.
- Open wire construction also provides the ventilation required for items such as stereo, electronic and computer equipment.
- Minimal dust buildup.
- Easy to assemble.
- Adjust shelf spacing in seconds.
- Various post heights available.
- Choose from standard and custom colors.
- Color coordinated accessories create fully functional merchandising unit.
- Custom configurations available.

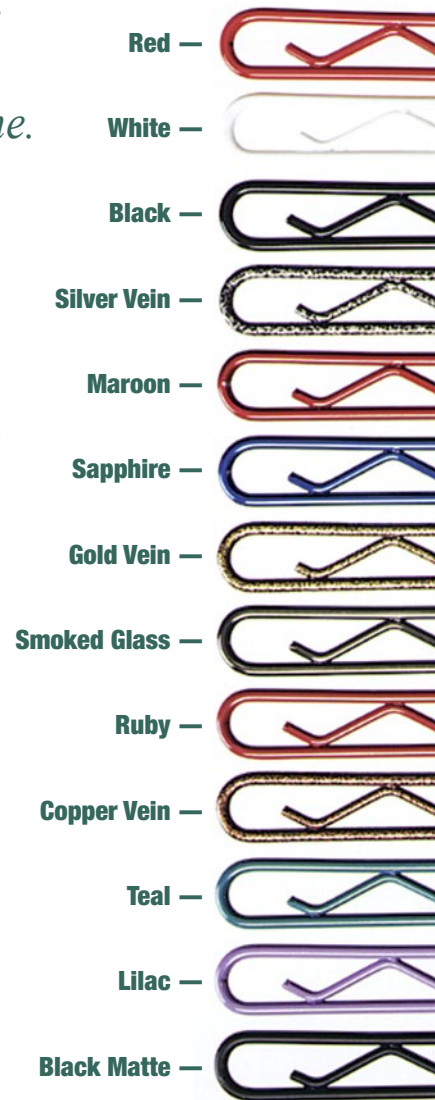

Point-of-Purchase Display with hardwood and Quad-Truss® shelving



Secure Display Merchandiser with low-voltage lighting and wall grid panel



Front Case Merchandiser shown with Add-A-Shelf® adjustable shelf

Deflection tests conducted under laboratory conditions show that EAGLE GROUP's patented QuadTruss® shelving is up to 25% stronger than competing wire shelving products.



Aisle Merchandising carts with Add-A-Shelf® reverse mat shelves

Wine Shelving



Cradle Wine Shelves NSF

Convert your existing shelving by adding cradle wine shelves.

- These shelves “cradle” each bottle via heavy gauge wire for stability.
- Open-wire construction keeps contents visible for quick inventory checks.
- Shelves are 14” wide and are offered in lengths of 36” and 48”.
- Available in black epoxy or chrome plated finish.

Bulk Wine Shelf Units NSF

Largest capacity offered in the industry for bulk storage.

- Each compartment is adjustable for bottle diameter and holds one dozen bottles per compartment.
- Bottles are retained with removable dividers, back panels. Panels are chrome plated steel.
- Shelves — available in black epoxy or chrome plated finish — are 14” wide and are offered in lengths of 36” and 48”.
- Height of all units is 74”.

Note: Recommended for stationary use only.

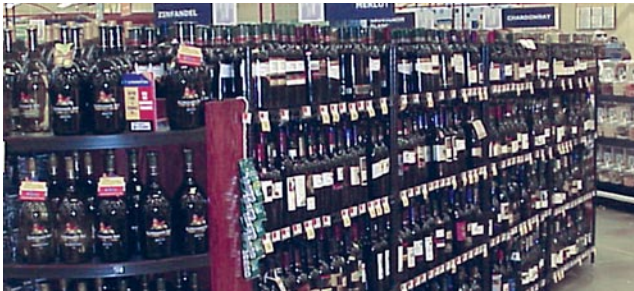

Shelves are adjustable and accommodate different size stock supplies. Cradle wine shelves and bulk wine units accommodate back room storage or front displays. Specially designed to reduce the risk of bottle breakage and instability.

Retail Display Shelving

Wire Display Shelving NSF

- Used primarily for gondolas and designed for use on all major shelving fixtures.
- Shelf brackets are one-piece, tier-notched to hold display shelf securely, and can be positioned horizontally or slanted.
- Shelves hold up to 40 lbs. per linear foot and feature EAGLEbrite® with MasterSeal® coating for improved rust protection.
- Available in 3’ and 4’ lengths, and up to 20” width.
- Wall standards and dividers are available.



Gondola Inset Shelving (hardware display)



Gondola Wire Shelving (pharmacy display)



Quad-Truss® Wire Shelving - 1860 Shelf Shown

Eagle Group shelves incorporate more serpentine trusses (both perimeter and interior) and mat continuity support wires than any competitive shelf, which translates into more strength per shelf.

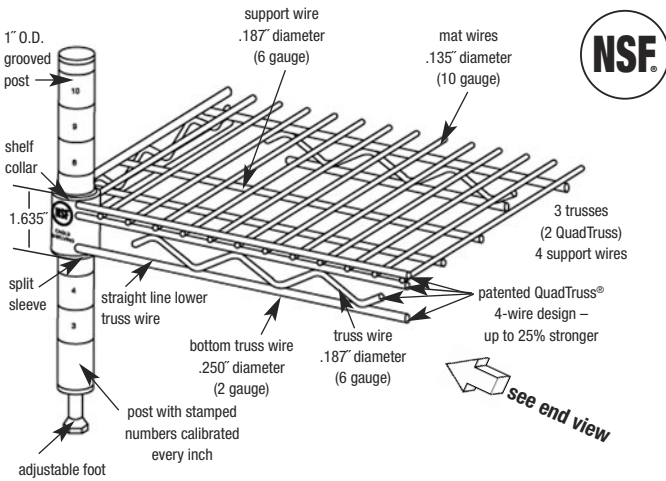

patented
QuadTruss®
design

(Patent #5,390,803)

Patented QuadTruss® design (U.S. Patent #5,390,803) uses four truss wires for up to 25% greater strength!!!

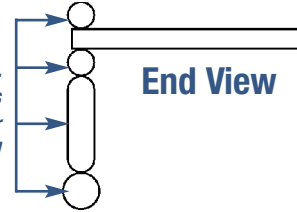

The EAGLE Advantage — quality, value, reliability!

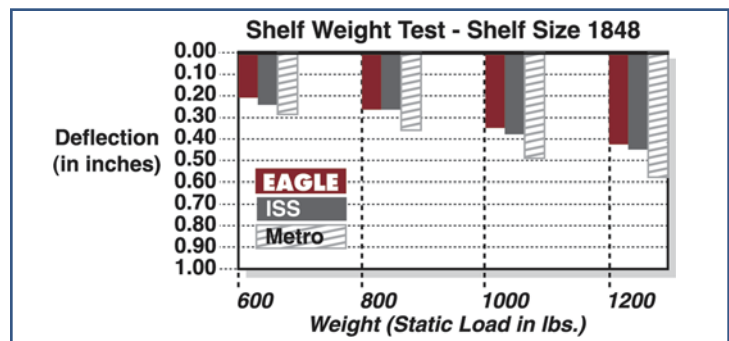

Static Load in lbs.	600 lbs.	800 lbs.	1000 lbs.	1200 lbs.
Static Load in kg	272.2 kg	362.9 kg	453.6 kg	544.3 kg
EAGLE	0.204	0.259	0.343	0.415
ISS	0.211	0.260	0.360	0.430
Metro	0.278	0.349	0.476	0.575

THE PATENTED QUADTRUSS® SYSTEM MAKES EAGLE GROUP WIRE SHELVING PRODUCTS THE STRONGEST IN THE INDUSTRY.

IN ADDITION, THE MAT ON AN EAGLE GROUP SHELF UTILIZES A QUADTRUSS® PINCHER-TYPE DESIGN WITH THE MAT WIRE SANDWICHED BETWEEN THE TWO TOP TRUSS WIRES, ADDING SIGNIFICANT STRENGTH AND DISTRIBUTING THE ENTIRE LOAD WITHOUT STRESS AND STRAIN ON THE WELDS.

DEFLECTION TESTS CONDUCTED UNDER LABORATORY CONDITIONS SHOW THAT EAGLE GROUP PATENTED SHELVING IS UP TO 25% STRONGER THAN COMPETING WIRE SHELVING PRODUCTS.

© 2021 EAGLE GROUP. Although every attempt has been made to ensure the accuracy of the data contained in this publication, we cannot be responsible for omissions, typographical or printing errors. Corian® is a trademark of DuPont. Standouts™ is a trademark of EAGLE GROUP Foodservice Equipment, a division of the EAGLE GROUP. adjusTable®, EAGLEgard®, EAGLEbrite®, Level-Lok®, LIFESTOR®, MasterTrak®, MasterSeal®, MICROGARD®, VALU-MASTER®, Quad-Adjust®, QuadTruss®, QuadPLUS®, and WalStor® are registered trademarks of EAGLE GROUP Foodservice Equipment, a division of the EAGLE GROUP.



Quality

Value

Reliability

Profit from the Eagle Advantage®

Corporate Headquarters • 100 Industrial Boulevard
Clayton, DE 19938-8903
• Phone: (302) 653-3000

Foodservice, Material Handling, • Phone: (800) 441-8440
and SpecFAB® Divisions • Fax: (302) 653-2065

www.eaglegrp.com



EG7014 Rev. 08/21