



ABC Combi Gas Oven

ABC7G

NAT /
ML-137715
NATP /
ML-137717

- NOTICE -

This Manual is prepared for the use of trained Hobart Service Technicians and should not be used by those not properly qualified.

This manual is not intended to be all encompassing. If you have not attended a Hobart Service School for this product, you should read, in its entirety, the repair procedure you wish to perform to determine if you have the necessary tools, instruments and skills required to perform the procedure. Procedures for which you do not have the necessary tools, instruments and skills should be performed by a trained Hobart Service Technician.

The reproduction, transfer, sale or other use of this manual, without the express written consent of Hobart, is prohibited.

This manual has been provided to you by ITW Food Equipment Group LLC ("ITW FEG") without charge and remains the property of ITW FEG, and by accepting this manual you agree that you will return it to ITW FEG promptly upon its request for such return at any time in the future.

TABLE OF CONTENTS

SERVICE UPDATES	4
SERVICE UPDATES - ABC COMBI GAS OVEN	4
TIS DOCUMENT LIST - ABC COMBI GAS OVEN	4
GENERAL	6
INTRODUCTION	6
OPERATION, CLEANING AND MAINTENANCE	6
TOOLS	6
LUBRICATION	6
WATER QUALITY STATEMENT	6
SPECIFICATIONS	7
UPGRADE ABC COMBI FIRMWARE	9
FIRMWARE VERSION HISTORY	9
FIRMWARE UPDATE PROCEDURE	11
USB ERROR MESSAGES	12
REMOVAL AND REPLACEMENT OF PARTS	14
PANELS	14
INNER DOOR	15
INNER DOOR LATCH	15
DOOR LAMP	16
DOOR LATCH	16
DOOR SWITCH	18
MAIN CONTROL BOARD	19
OXYGEN SENSOR	19
OXYGEN SENSOR BOARD	20
FERRITE	21
MOTOR CONTROL BOARD	22
CONTROL BOX COOLING FAN	22
CONTROL PANEL	23
CONTROL PANEL COOLING FAN	25
ON / OFF SWITCH	26
KNOB & ENCODER	26
DISPLAY BOARD	27
MEAT PROBE SOCKET	28
REAR COOLING FAN	29
HIGH-LIMIT THERMOSTAT	30
CAVITY INTAKE TUBE ASSEMBLY	30
CAVITY VENT MOTOR	31
CAVITY VENT SWITCHES	32
TRANSFORMER	33
TEMPERATURE SENSOR (RTD1)	34
DRAIN WATER CONDENSATE VALVE	35
DRAIN WATER THERMOCOUPLE	36
HUMIDITY VALVE	37
CONVECTION FAN BAFFLE	37
CONVECTION FAN MOTOR	38
GAS VALVE	40
IGNITOR	41
FLAME SENSOR	41
INDUCER BLOWER	42
HEAT EXCHANGER ASSEMBLY	43
DRAFT INDUCER PRESSURE SWITCH	45
IGNITION MODULE	45
SERVICE PROCEDURES AND ADJUSTMENTS	47

CONFIGURATION MODE (1972) - GAS	47
CALIBRATING OXYGEN SENSOR BOARD	54
CHECK OXYGEN SENSOR DATE CODE (REPLACEMENT SENSORS)	55
TEMPERATURE SENSOR (RTD1) TEST	56
TEMPERATURE CALIBRATION	56
EXTERNAL MEAT PROBE THERMOCOUPLE CALIBRATION	57
CAVITY VENT SWITCH TEST AND ADJUSTMENT	57
DOOR TO CONTROL PANEL ALIGNMENT	59
DOOR SWITCH ADJUSTMENT	62
TRANSFORMER RESISTANCE CHECK	62
MOTOR RESISTANCE CHECK	64
GAS VALVE PRESSURE CHECK AND ADJUSTMENT	65
FLAME SENSE VOLTAGE TEST (FENWAL SERIES 35-61)	66
DRAFT INDUCER TEST	67
COMBUSTION ANALYSIS	67
ELECTRICAL OPERATION	69
COMPONENT FUNCTION	69
ELECTRICAL PANEL COMPONENT LOCATION	72
SEQUENCE OF OPERATION	73
CONDITIONS	73
ON/OFF SWITCH (SW4) TURNED ON, (NO CALL FOR HEAT)	74
ON/OFF SWITCH (SW4) ON & WITH CALL FOR HEAT	75
ON/OFF SWITCH (SW4) ON & WITH CALL FOR HEAT & CALL FOR HUMIDITY	76
OTHER SEQUENCES	77
CIRCUIT BOARD LAYOUTS	80
MAIN BOARD CONNECTIONS	80
MOTOR BOARD	83
IGNITION MODULE	84
WIRING DIAGRAMS	85
TERMINAL BLOCKS AND TRANSFORMER	86
MAIN BOARD	87
MOTOR BOARD	88
IGNITION MODULE	89
COOLING FANS	90
DIAGNOSTICS / TROUBLESHOOTING	91
SERVICE MODE (1963)	91
ERROR CODES	97
OVEN TROUBLESHOOTING	103
IGNITION CONTROL MODULE TROUBLESHOOTING	120
IGNITION CONTROL MODULE TROUBLESHOOTING	120

SERVICE UPDATES

SERVICE UPDATES - ABC COMBI GAS OVEN

November 2021

- Updated CONTROL PANEL.

May 2018

- Updated all chapters due to firmware update in this service manual.

NOTE: Upgrade ABC Combi Firmware 04-24-17.

- FIRMWARE VERSION HISTORY .
- FIRMWARE UPDATE PROCEDURE .
- MEAT PROBE SOCKET .

TIS DOCUMENT LIST - ABC COMBI GAS OVEN

SERVICE TAB	
Document Title	Document Type
ABC Combi Gas Oven Service Manual	Service Manual
ABC Combi Ovens - Door-to-Control Panel Alignment Service Kit Instructions	Service Kit Instructions (SKI)
ABCG & ABCE Combi Stacking Kit	Service Kit Instructions (SKI)

SERVICE TAB (Multimedia)	
Document Title	Document Type
Did You Know - ABC Combi	Misc.
Repair Flood-Damaged Equipment	Service Bulletin
ABC Gas and Electric Combi Ovens I&O Manual	Operator
Fundamentals of Gas	Service Instructions
Hobart Water Filter Replacement Cross Reference Sheet	Service Instructions
ScaleStick Twin system, Part No. 01-234301-51200 Installation Instructions	Service Instructions
ABC7G Gas Combi Oven Spec Sheet	Specification Sheet
Rating Plate Locations on Current Vulcan-Hart	Technical Service Bulletin (TSB)
TSB 1393 Steam Cooking Equipment - Prevention, Detection and Treatment of Corrosion on Stainless Steel	Technical Service Bulletin (TSB)
TSB 1037A Hobart to Vulcan "Common" Model Cross Reference List	Technical Service Bulletin (TSB)

PARTS TAB	
Document Title	Document Type
ABCE Combi Parts Catalog	Parts Catalog

DIAGRAMS TAB	
Document Title	Document Type
ABC Combi Gas Wiring Diagram	Wiring Diagram

TROUBLESHOOTING TAB	
Document Title	Document Type
ABC Combi Troubleshooting	Troubleshooting

GENERAL

INTRODUCTION

General

This manual is for ABC7 Combi ovens. Ovens feature a powered vent damper, and an advanced digital control panel with digital display for setting cook TEMPERATURE, TIME, and HUMIDITY.

Heating

The ABC Combi oven reaches baking temperature of 350°F at 0% humidity in approximately 5½ to 6 minutes; however, a 20-minute preheat is recommended.

Combi Ovens

Combi ovens provide convection heat, steam heat or a combination of both in a single compartment cooking chamber. Humidification is provided by water injection into oven cavity. Water is injected by means of an internal nozzle, and vaporizes on contact with hot interior surfaces.

Steam System

All combi ovens come with a boilerless flash steaming system which provides a quick response time as well as excellent cooking results.

All information, illustrations and specifications contained in this manual are based on latest product information available at time of release.

OPERATION, CLEANING AND MAINTENANCE

Refer to Installation & Operation Manual (F47110) for specific operating instructions.

TOOLS

Standard

1. Standard set of hand tools.
2. Metric set of hand tools.
3. VOM with minimum of NFPA-70E CAT III 600V, UL/CSA/TUV listed. Sensitivity of at least 20,000 ohms per volt. Meter leads must also be rated at CAT III 600V. Clamp on type amp meter with minimum of NFPA-70E CAT III 600V, UL/CSA/TUV listed.

4. Inclined manometer - Dwyer Cat #1227 or equivalent.
5. 1/4" T with 1/4" tubing.
6. Temperature tester (thermocouple type).
7. Field service grounding kit.

Special

1. Combustion analyzer.
2. M6 socket head cap screw 3" long (hardened black oxide finish) for removing convection fan from motor shaft.
3. Gear puller to remove CONVECTION FAN MOTOR.
4. USB Drive (Part # 00-443444).
5. No-Go / Go Gauges for DOOR TO CONTROL PANEL ALIGNMENT.
 - A. No-Go Gauge - .200"
 - Use .032", .030", .028", .025", .022", .020", .018", .015", and .010" feeler gauges to make a .200" No-Go gauge.

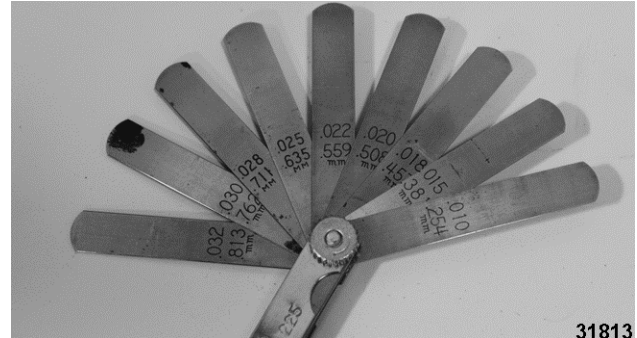

Fig. 1

- B. Go gauge - .119"
 - Use .032", .030", .028", .025" and .004" feeler gauges to make a .119" Go gauge.

LUBRICATION

NOTE: Ovens have self-lubricating composite bearings. No lubrication required.

WATER QUALITY STATEMENT

The fact that a water supply is potable is no guarantee that it is suitable for steam generation. Proper water quality can improve the taste of the food prepared in

the oven, reduce scale build-up or corrosion, and extend equipment life. Local water conditions vary from one location to another and can change throughout the year. The recommended water treatment for effective and efficient use of this equipment will vary depending on the local water conditions. Your water supply must be within the general guidelines outlined in the chart below at all times during use of this machine or service issues not covered under warranty may result.

Water hardness should be treated by removing the impurities (water softener with carbon block or dechlorinator and/or in-line water treatment). Low water hardness may also require a water treatment system to reduce potential corrosion. Water treatment has been shown to reduce costs associated with machine cleaning, reduce delimiting and reduce corrosion of metallic surfaces.

Daily washing and rinsing of the cavity is required. In some cases, it may be needed more than once a day to prevent compounding of contaminants deposited inside cavity even with acceptable filtration. Failure to wash and rinse down the cavity daily could result in damage of the oven cavity and interior parts. A Reverse Osmosis water treatment system can be installed to eliminate chlorides or other contaminants from the water if needed.

NOTE: Failure to properly maintain water quality or preventative procedures for water can lead to issues not covered under warranty.

⚠ WARNING

Plumbing connections must comply with the applicable sanitary, safety and plumbing codes.

WATER SUPPLY GENERAL GUIDELINES ¹	
Supply Pressure (dynamic flow)	30-60 psig
Hardness	less than 3 grains (17.1 ppm = 1 grain of hardness)
Silica	less than 13 ppm
Chloramines ²	zero
Chlorides ²	less than 30 ppm ³
Total Chlorine ⁴	zero
PH	range 7-8
Undissolved Solids	less than 5 microns

¹ Testing of water is always done AFTER water filter or water treatment used. Water quality does

change with usage and should be checked after idle times to see if the condition worsens.

² A carbon block filter system should always be used to remove Chlorine and Chloramine. If a water softener is used, a carbon block is still required. Check with your local water treatment specialist for proper sizing and replacement intervals for the carbon block cartridge.

³ If the Chlorides exceed 30 ppm and the oven is used more than 8 hours during the day in steam or combination mode, the cavity will require rinsing every 8 hours. Failure to do so will result in corrosion and rusting of the oven cavity and interior parts. A Reverse Osmosis water treatment system can be installed to eliminate chlorides from the water and reduce the hardness. Preventative washing and rinsing may be needed more than once a day to prevent compounding of contaminants inside cavity.

⁴ Total Chlorine of 4.0 ppm is the max limit for the building water supply. A carbon block filter must still be used to remove all Chlorine and Chloramines from the water. Failure to do so will result in corrosion and rust in the cooking cavity, which is not covered under warranty.

SPECIFICATIONS

Data

⚠ WARNING

Appliances equipped with a flexible electric supply cord are provided with a three prong grounding plug. It is imperative that this plug be connected into a properly grounded three prong receptacle. If the receptacle is not the proper grounding type, contact an electrician. Do not remove grounding prong from this plug.

⚠ WARNING

Electrical and grounding connections must comply with the applicable portions of the National Electrical Code and / or other local electrical codes.

NOTE: The spark ignition in this appliance can cause electrical noise that can false trigger the GFCI detection. Some GFCI's are more sensitive than others. The use of a higher trip tolerance GFCI will reduce nuisance tripping. Contact Technical Support for more information.

Supply Voltage			
Volts	Amps	Hertz	Phase
120	5.0	60	1

Supply Gas Pressure		Input
Natural	Propane	BTU/HR
5" - 14" W.C.	11" - 14" W.C.	80,000

Water Supply

A cold water supply with a flow pressure of 30 to 60 psi is required.

There is a 3/4" garden hose fitting located on rear of machine labeled FILTERED. This inlet must be connected to approved filter system. Failure to connect oven to approved filter system will void warranty.

There is also a 3/4" garden hose fitting located on rear of machine labeled NON-FILTER.

Plumbing Connections



Plumbing connections must comply with the applicable sanitary, safety and plumbing codes.

Drain Connection

The drain connection must be plumbed with a minimum of 1" air gap. Drain water cannot be greater than 140°F, upon discharge. There is a 1" NPT male port for drain. Drain plumbing, not supplied, should have a constant slope towards floor drain. Do not connect solidly to floor or other drains.

UPGRADE ABC COMBI FIRMWARE

FIRMWARE VERSION HISTORY

This section contains history of ABC7 Combi Oven Firmware. The release date of Firmware is how it is identified. The table below lists release date and a short explanation of features / fixes which were introduced with that particular version.

NOTE: Current version of firmware loaded into oven can be identified with Parameter P0 in Service Mode (1963) or Configuration Mode (1972). The current version of in-application program (IAP) shows briefly on the Timer display when USB is inserted.

Firmware Version / (Release Date)	Comments
022514 (02-25-14)	<ul style="list-style-type: none"> • First production release FIRMWARE. • IAP6.15 (in-application program) loaded to read USB port. • Rev 11 oxygen board code. • Main board identified with 'red wire' on T1, (256k flash, STM32F207VCT6, 01/14-08/16, #266-#1185).
081114 (08-11-14)	<ul style="list-style-type: none"> • IAP6.15 (in-application program) loaded to read USB port. • Rev 11 oxygen board code. • Main board identified with 'red wire' on T1, (256k flash, STM32F207VCT6, 01/14-08/16, #266-#1185). • Main board identified with 'red wire' on T1, (1024k flash, STM32F207VGT6, 10/16, #1224-#1316). <p>Serial Numbers</p> <ul style="list-style-type: none"> • 541074335 (-NAT) • 541074349 (-208V) • 541075058 (-240v) • 541074355 (-480v) <p>Combi Changes</p> <p>Fixed a motor board hardware issue with the E6 error. Motor current sense circuit would lock up and the oven sensed a "false positive" current going to the convection motor, causing an E6 motor.</p> <p>Fixed an issue with the P4, P5 and P6 custom temperature settings. It fixes an issue with the custom temps feature, in which initial lowest temp value when turning up from standby could be out of P15/16 range, if the only enabled custom temps are above/below P15/16.</p> <p>In Configuration Mode (1972), increases maximum temperature setting in parameter P15 to 482F.</p> <p>NOTE: Ovens with Serial Numbers prior to 541073334 must have their High Limit Thermostat changed before the setting of the maximum temperature can be set above 450F.</p>

Firmware Version / (Release Date)	Comments
042417 (04-24-17)	<ul style="list-style-type: none"> • IAP6.21 (in-application program) loaded to read USB port with Rev 12 oxygen board code. • Main Board identified with 'green wire' on T1, (1024k flash, STM32F207VGT6, 01/17+, #1317+). • Oxygen Sensor, Revision C, August 2016. <p>Starting Serial numbers FIRMWARE</p> <ul style="list-style-type: none"> • 541083050 (-NATP) or 541083053 (-208P, -240P, -480P) • 541083068 (-NAT) or 541083068 (-208, -240, -480) <p>Backward Compatibility</p> <p>The 4-24-17 firmware is backward compatible to ovens with 8-11-14 or 2-25-14. It is highly recommended that the upgrade to IAP 6.21 and Rev 12 oxygen board software be completed at the same time. However, if the IAP and oxy boards are not also upgraded, the oven will still work but without benefit of the E14 and E28 diagnostics and new functionality thereof.</p> <p>IAP Changes</p> <p>Work-around for damaged USB port on Main board. If proper operation of USB port on main board is not properly detected in 1 second, the USB port is ignored. Fixed rare issue with USB_HOST_CONN shown on display interrupting normal oven operation. Pairs with Combi firmware addition of E14 error.</p> <p>Combi Changes</p> <ul style="list-style-type: none"> • Changed Service Test Mode (1963). <ul style="list-style-type: none"> • Added additional oxygen sensor tests: o5, o6, o7, Pb. • Added error codes: E14 (USB-requires IAP 6.21), E21 (motor speed), E29 (rtd). • Removed error code E16 removed & replaced with E22, E23, E24, E25, E26, E27, E28 (E28 Requires Revision 12 oxygen board firmware). • Changed Configuration Mode (1972). <ul style="list-style-type: none"> • Changed P12 (motor speed). Added P21 (probe calibration), P29 (cook 2 probe UI), P34 (humidification method). • Changed defaults P25 and P26 for drain water tempering for new style drain with bent tube assembly, current production for starting s/n's: <ul style="list-style-type: none"> 541082447 (-NAT) OR 541082442 (-208) 541082482 (-240) 541082425 (-480) • Added P76 (factory only) to calibrate TC1 & TC2 thermocouple based on TC2 external meat probe thermocouple analog offset (after 2-minute temperature stabilization). Turning Timer knob switches Timer display to show uncalibrated probe temp (TC2 with P76 analog offset applied) for ease of calibration. • Changed User Interface.

Firmware Version / (Release Date)	Comments
	<ul style="list-style-type: none"> • Additional functionality of Cook-to-Probe and Fan Speed Control with push button encoder. Added fan speed to the time and humidity “recalled” settings when the on/off switch is turned on. (If oven is equipped: ABCx-xxxP devices only. Pairs with P29, P12, P21.) • Changed Operate Mode. <ul style="list-style-type: none"> • Removed the temperature augmentation to 220F, at temperature setpoints of 212-220F for enhanced steaming. • Removed sensor based valve/vent operation at the 100% humidity setpoint case and replaced with continual flow of Y9 low hum water valve while vent remains closed. Defaults to sensor based humidification at humidity setpoints of <100%. Pairs with configuration setting P34 (default=dis) for enhanced steaming. • Modified transfer function and calculations for additional accuracy on TC2 thermocouple reading for the cook-to-probe feature. Applies to all thermocouples. Pairs with Main board hardware modifications to the probe circuit as indicated by the “green” wire on T1. • Removed all audible “error beeps” for all non-critical errors. • Fixed a rare issue with the timer expiring/alarming when not previously set. Or which “no” or “HEAT” could show for a split second after closing the door. • General Fixes: <ul style="list-style-type: none"> • Change project target was STM32F207IGH6, 1M flash, now STM32F207VGT6, 1M flash corresponds to hardware change on Main board. • Update to stm32 2.28 support package. Double the heap and stack size. (Software maintenance.)

FIRMWARE UPDATE PROCEDURE

1. Obtain a copy of ABCCombi.bin file and the IAP.bin file from the Hobart Service Resource Center and load it onto a USB flash drive (thumb drive).

NOTE: The file must be loaded in the root directory in the USB flash drive.

2. Remove RIGHT PANEL.
3. Re-apply power to oven and ensure door is closed.
4. Review and record oven's unique information.

NOTE: The oven's internal memory is reconfigured, and set to factory default when updating from 8-11-14 to 4-24-17. It is necessary to record any unique information.

- A. Write down any custom settings in Configuration Mode (1972) Parameters P4, P5, P6. These settings must be re-configured after firmware update.

- B. Review (or Error Download to USB Flash Drive) the Error Log and Counter data in 1963 Service Test Mode for your records or analysis.

NOTE: Oven memory will not be overwritten when upgrading from 4-24-17 to future revisions.

5. Place the Oven in Idle Mode (Temperature display - - -).
 - No Set Temperature.
 - Not in service test mode (1963).
 - Not in configuration mode (1972).
6. Insert the USB flash drive into the oven's USB-A port.

NOTE: The convection fan motor may or may not come on when the USB flash drive is inserted.

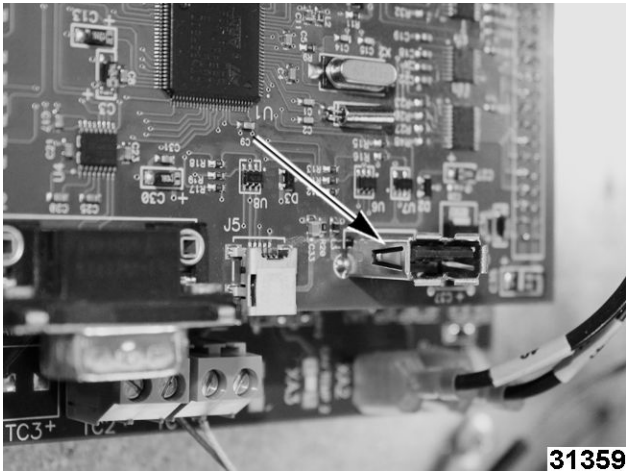

Fig. 2

7. View the LED displays on the front of the oven.
 - The oven briefly flashes the in-application program version IAP 6.21 on the timer display.
8. "Usb Flsh n_y" appears on the display.
 - If something other than "Usb Flsh n_y" is displayed, then refer to USB ERROR MESSAGES.
 - If "n" is selected with the humidity knob (turned to the left, ccw), the oven will return to Idle mode. Firmware not updated.
 - If "y" is selected (turned to the right, cw), the humidity display briefly changes to show "yes", then "del" as the necessary flash is deleted, then begins showing a percentage complete from 0-100 as the software image is flashed. When flashing is complete (usually after a few seconds), the humidity display briefly shows "don", which indicates the software flashed correctly. Oven returns to the Idle Mode (Temperature display ---). Firmware is updated.
9. Enter Configuration Mode (1972),
 - Verify that parameter P0 now shows 4-24-17 as the firmware revision code.
 - Enter oven hour count, found in parameter P18 on the service ticket.
10. Update the In-Application Program (IAP).

NOTE: Updating the IAP is highly recommended when updating firmware from 8-11-14 to 4-24-17 or later versions. Required for proper operation of the E14 error and "USB HOST COnn" fix.

NOTE: When updating firmware from 4-24-17 to later versions skip to step 11.

- A. Continue in configuration mode (1972), with the USB flash drive remaining inserted.
- B. Turn temperature knob clockwise to P72. "2000" shows on timer display.
- C. Turn timer knob counterclockwise to enter password "1972" allowing access. "Eng" shows on timer display.
- D. Turn temperature knob counterclockwise to P65. Display will show "FIAP no".
- E. Turn humidity knob clockwise to select "yes" to request IAP firmware update. Display will show "IAP FLSH n_y".

NOTE: If oven does not respond, select "yes" again.

- F. Turn humidity knob counterclockwise to select "y" and initiate IAP download. Selecting "n" will cancel back to P65.
 - Display will show "USb flsh don".
 - Display will briefly show "IAP 6.21" (watch for this to verify the IAP updated correctly).
 - Display will show "IAP FLSH n_y", asking to re-flash the oven firmware (not IAP firmware) again. Select "n", but you can select either "y" or "n" without issue.
 - Oven exits configuration mode, and returns to Idle Mode (Temperature display ---).

11. Remove USB flash drive.

Updating the Oxygen Sensor Board Firmware

Oxygen sensor board firmware cannot be updated remotely and must be replaced to get the current revision. Contact your local Hobart Service office for the latest replacement part.

USB ERROR MESSAGES

Error Message	Corrective Action
Usb Host Con or Usb Host Enu	Remove USB drive. When temperature display returns to "---", reinsert USB drive.
Usb No Fil:	The ABCCombi.bin file was not found on USB drive. Reload ABCCombi.bin file.
USB Fail < 1, 2 or 3 >	USB drive needs to be formatted in FAT32 format. If this fails use a different USB drive.
USB Fail < 4-5, 7-8 or 15-18 >	Remove USB drive. When temperature display returns to "---", reinsert USB drive. If error persists, use a different USB drive.
USB Fail < 9-14>	Remove USB drive. When temperature display returns to "---", reinsert USB drive. If error persist, replace Main Control Board

REMOVAL AND REPLACEMENT OF PARTS

PANELS



WARNING

Disconnect the electrical power to the machine and follow lockout / tagout procedures.

Right Panel

1. Remove four right panel screws.
2. Lift right panel up and back using handles.

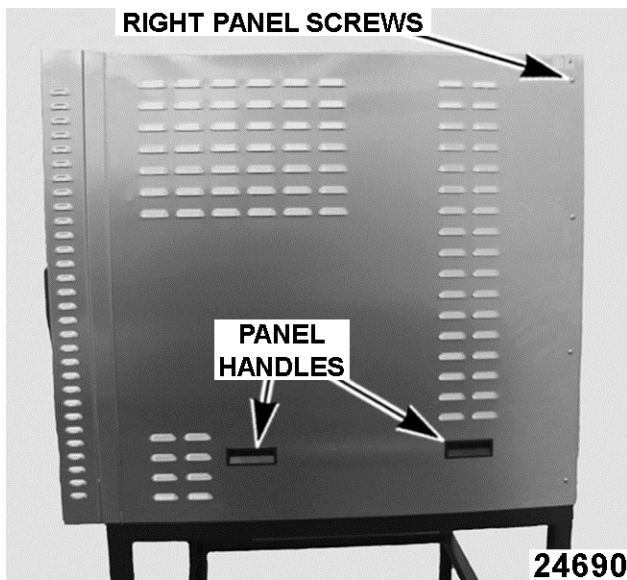

Fig. 3

3. Reverse procedure to install.

Rear Panel

1. Remove RIGHT PANEL.
2. Remove two fan screws (1, Fig. 4).
3. Remove six utility panel screws (2, Fig. 4).

NOTE: Bottom two utility screws only support utility panel and can be left assembled.

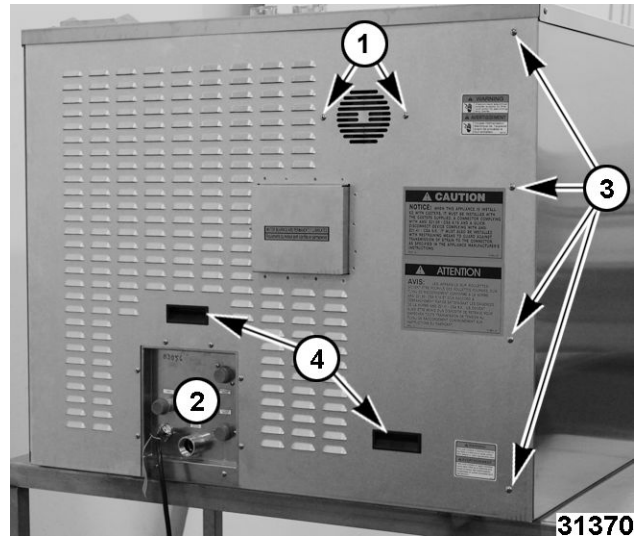

Fig. 4

4. Remove screw in the upper right hand corner on right side of oven.

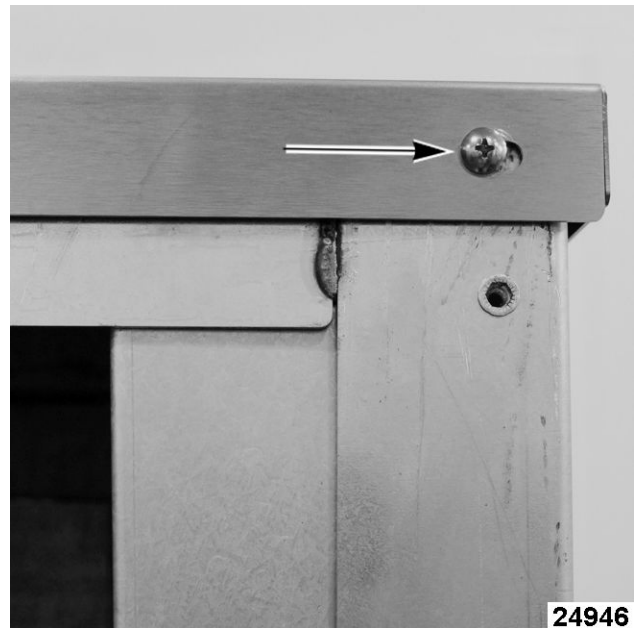

Fig. 5

5. Remove four rear panel screws (3, Fig. 4).

NOTE: Hold onto one panel handle to prevent rear panel from falling.

6. Lift with handles (4, Fig. 4) to remove.
7. Reverse procedure to install.

Left Panel

1. Remove RIGHT PANEL.
2. Remove REAR PANEL.

3. Remove screw in the upper left hand corner on left side of oven.
4. Lift left panel up and back towards the rear of unit.

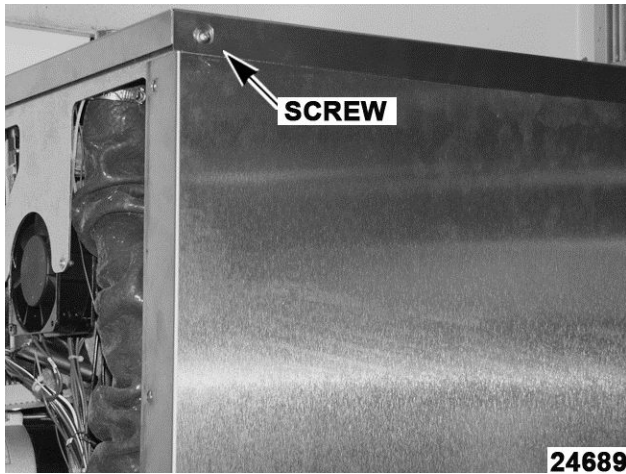

Fig. 6

5. Reverse procedure to install.

INNER DOOR

1. Open oven door.
2. Unlatch inner door using inner door latch.

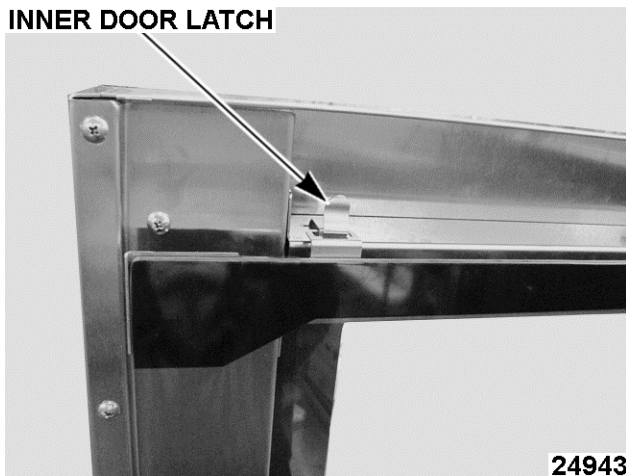

Fig. 7

3. Lift inner door up off door hinge.

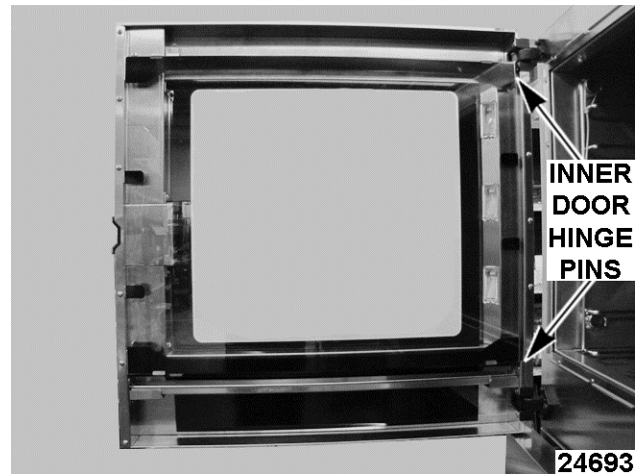

Fig. 8

4. Place inner door in a secure location to prevent damage.
5. Reverse procedure to install.

INNER DOOR LATCH

1. Remove INNER DOOR.
2. Remove upper door stiffener screws from both ends and remove upper door stiffener.

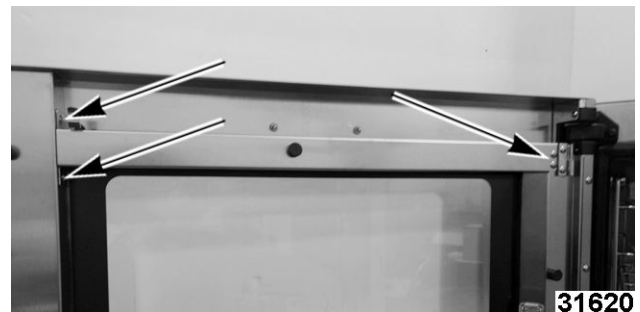

Fig. 9

3. Remove inner door latch screws.

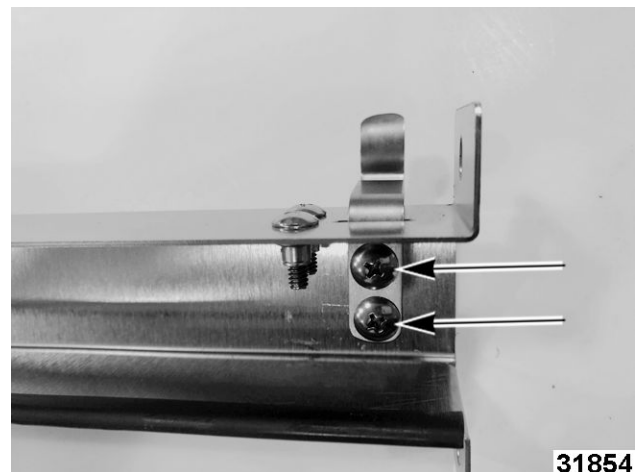

Fig. 10

- Reverse procedure to install.

NOTICE

Apply Blue Loctite 243 to inner door latch screws and inside stiffener screws.

NOTICE

Apply Purple Loctite 222 to the upper door stiffener screws.

NOTICE

Tighten screws to 24 in. lb.; do not overtighten.

- Check for proper operation.

DOOR LAMP



WARNING

Disconnect the electrical power to the machine and follow lockout / tagout procedures.

NOTE: Previous production ovens had three 5W lamps. Current production ovens have one 10W lamp.

- Remove INNER DOOR.
- Insert screwdriver in slot just above screw.

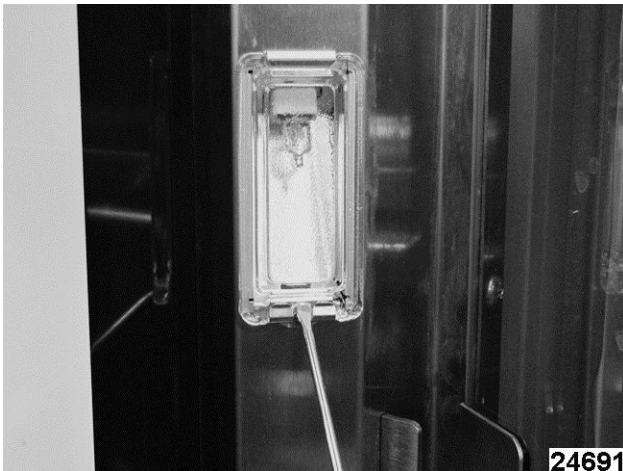

Fig. 11

- Push in tab to free glass cover from lamp holder.
- Grasp lamp using cloth and remove from lamp socket.

NOTICE

Do not touch Halogen lamp with bare hands. If lamp is exposed to oil from skin, life of the Halogen lamp will be reduced. Skin oil may be removed with alcohol while lamp is cold.

NOTE: Use a clean rag or paper towel to handle replacement lamp. Ensure lamp is free from oil and dirt before replacing.

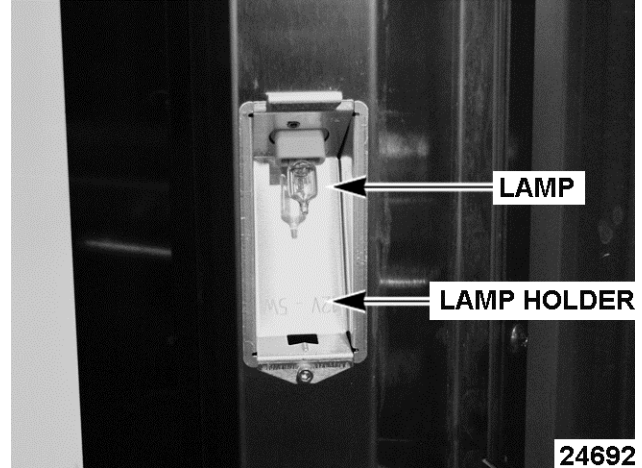

Fig. 12

- Reverse procedure to install.

DOOR LATCH

WARNING

The oven and its parts are hot. Use care when operating, cleaning or servicing the oven. The cooking compartment contains live steam. Stay clear when opening door.

Door Cam

- Open door and remove INNER DOOR.
- Remove door lock cover.



Fig. 13

3. Remove cam screw (1, Fig. 14) and washer.

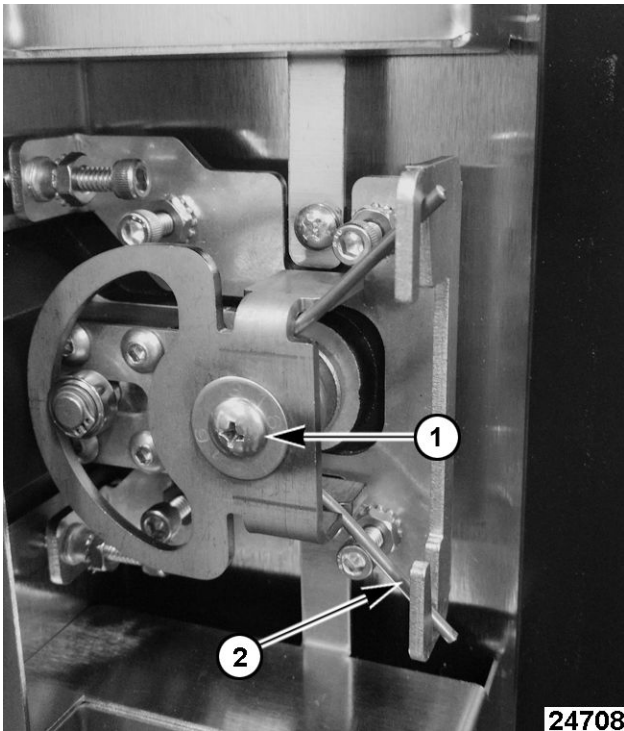

Fig. 14

4. Release torsion spring from lower slot (2, Fig. 14) in clamp bracket, then release top spring.
5. Press latch (1, Fig. 15) into door to remove cam (2, Fig. 15).

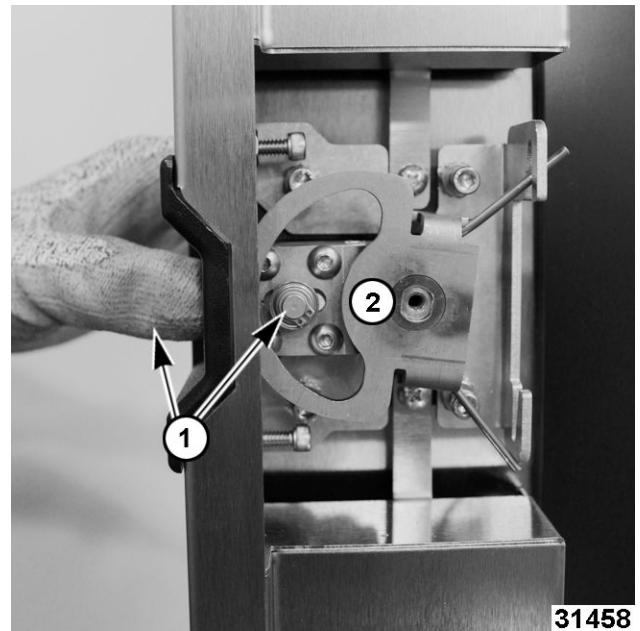

Fig. 15

Latch Assembly

1. Remove DOOR CAM.
2. Remove four allen screws (1-4 in Fig. 16) on plunger mechanism.

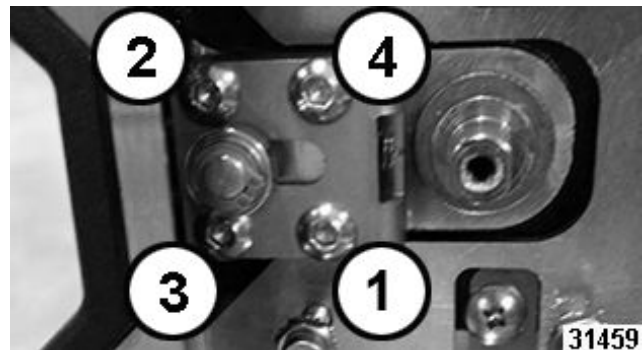

Fig. 16

3. Reverse procedure to install.

NOTE: When installing new plunger, tighten allen screws in crisscross pattern as numbered in Fig. 16 torque to 24 in. lbs.

4. Check for proper operation.

NOTICE

Apply pressure to door latch to verify smooth movement.

DOOR SWITCH



WARNING

Disconnect the electrical power to the machine and follow lockout / tagout procedures.

1. Remove CONTROL PANEL.

NOTICE

Do not place control panel on knobs. Doing so will damage encoders. Lift one side of control panel up to prevent knobs from touching surface.

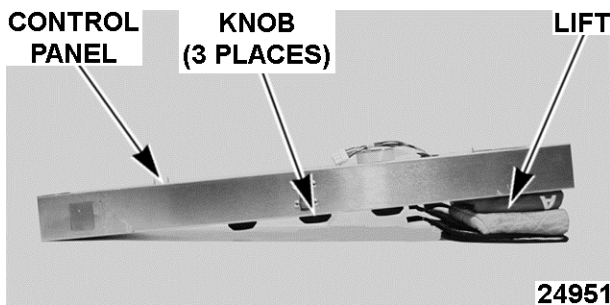

Fig. 17

2. Remove back control panel.
3. Remove two lock nuts (1, Fig. 18).

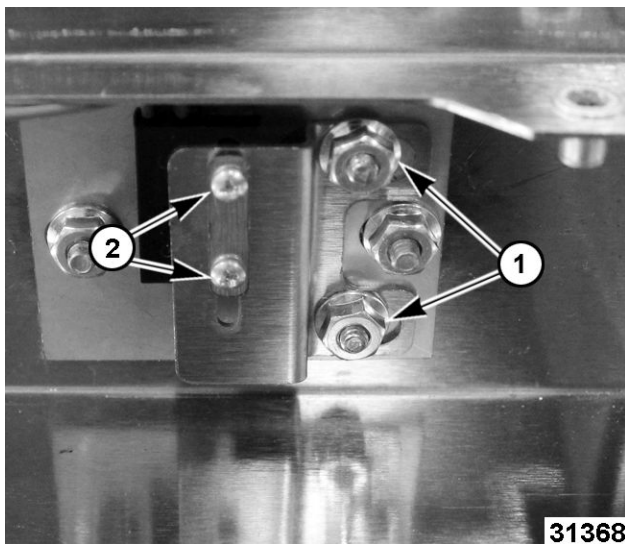

Fig. 18

4. Remove two screws (2, Fig. 18) to release switch from bracket.
5. Insert screwdriver into switch wire connector and push down on lower side to release wires.

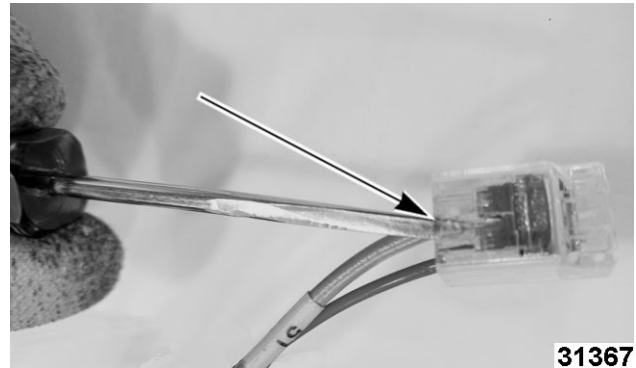

Fig. 19

6. Reconnect wires to connector.
7. Install switch into bracket. Must measure 3 1/2" from bottom of control box and 1-3/16" as shown in Fig. 20.

NOTICE

Measurements for switch placement are critical to door switch operation.

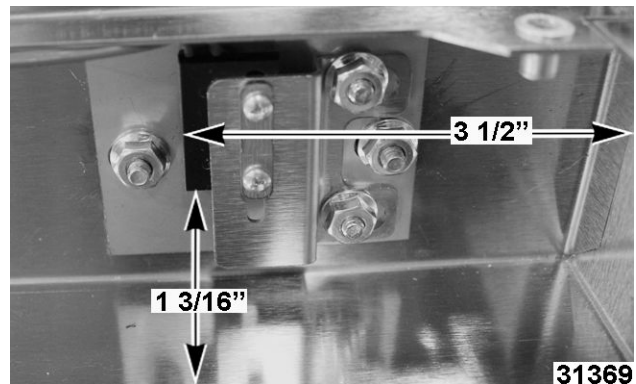

Fig. 20

8. Install control panel back cover.
9. Install control panel to oven.

NOTICE

The door operation (latch, handle and sealing) can be negatively affected any time the control panel has been moved for servicing. Verify door latch alignment with door by opening and closing door when Control Panel is loosely mounted **AND** when securely mounted. If door is not operational, perform DOOR TO CONTROL PANEL ALIGNMENT.

10. Verify door switch operation.

MAIN CONTROL BOARD

NOTICE

Certain components in this system are subject to damage by electrostatic discharge (ESD) during field repairs. An ESD kit is required to prevent damage. The ESD kit must be used anytime the circuit board is handled.

1. Check CONFIGURATION MODE (1972) - GAS for customer's current parameter settings.
Document customer's parameter settings.

NOTE: This step can only be accomplished if main control board is still operational.

NOTE: Oven hour counter (P18), water counter values (P19, P20), and error log will start new, with replacement main control board.



WARNING

Disconnect the electrical power to the machine and follow lockout / tagout procedures.

2. Remove RIGHT PANEL.
3. Note and disconnect electrical connections from main control board and oxygen sensor board.
4. Squeeze nylon standoffs to release and remove main control board.

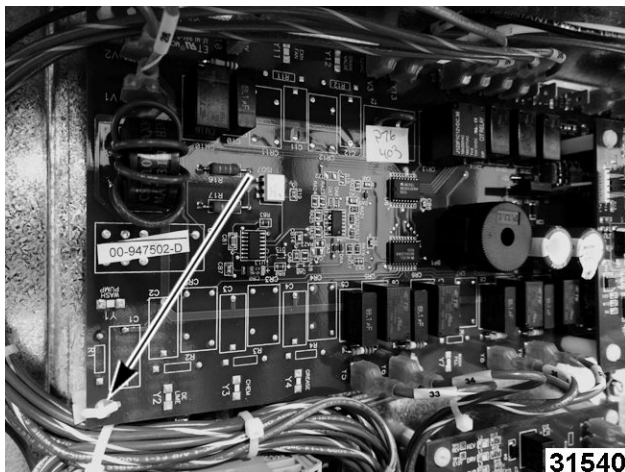

Fig. 21

5. Remove OXYGEN SENSOR BOARD from main control board.

Installation of Replacement Control Board

1. Install OXYGEN SENSOR BOARD onto replacement main control board.

NOTE: Oxygen sensor board is easier to install onto main control board before installing main control board.

2. Line up holes on new main control board with nylon standoffs (x10).
3. Press board onto standoffs.
4. Follow diagram MAIN BOARD CONNECTIONS to rewire replacement board.
5. Configure board to customer's preferred parameter settings for P25, P26, and P29 in configuration version. Refer to CONFIGURATION MODE (1972) - GAS for configuration settings.
6. Refer to CALIBRATE OXYGEN SENSOR BOARD if oxygen board is being replaced.
7. Check for proper operation.

OXYGEN SENSOR



WARNING

Disconnect the electrical power to the machine and follow lockout / tagout procedures.

WARNING

Oxygen sensor is very HOT. Use care when servicing oxygen sensor.

NOTE: Remove power from unit before replacing oxygen sensor. Having power to board when installing sensor will cause damage oxygen sensor.

NOTE: Sensor can be damaged by water. Do not get it wet.

1. Remove RIGHT PANEL.
2. Remove REAR PANEL.
3. Disconnect main board TC cable plug (1, Fig. 22) from oxygen sensor cable at plug (2, Fig. 22).

NOTE: Do NOT disconnect cable from Oxygen Sensor Board.

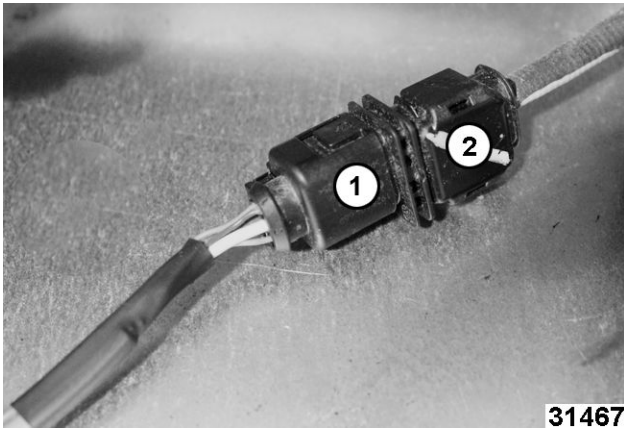

Fig. 22

WARNING

Allow oxygen sensor to cool completely before removing. Sensor, when powered and operating, is very HOT.

4. Remove all wire ties from oxygen sensor cable.
5. After oxygen sensor has cooled, loosen hex and carefully remove sensor from fitting.

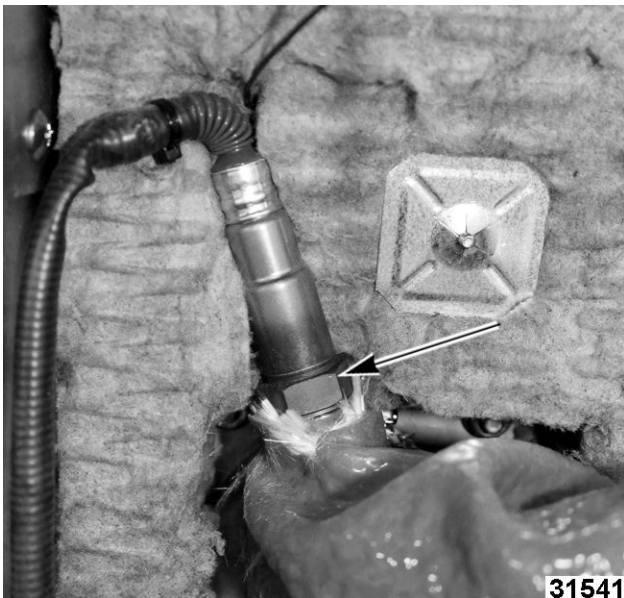

Fig. 23

6. Reverse procedures to install.
7. When installing, route oxygen sensor cable as previously installed.

NOTE: Inspect oxygen sensor extension cable for damage and replace if necessary.

NOTICE

Oxygen sensor cables are sensitive to electrical noise and must be routed away from other wires.

8. Power unit on.

9. Check for proper operation.

OXYGEN SENSOR BOARD



WARNING

Disconnect the electrical power to the machine and follow lockout / tagout procedures.

NOTICE

Certain components in this system are subject to damage by electrostatic discharge (ESD) during field repairs. An ESD kit is required to prevent damage. The ESD kit must be used anytime the circuit board is handled.

1. Remove RIGHT SIDE PANEL.
2. Note wire locations and remove connections from oxygen sensor board.
3. Remove oxygen sensor board screws. Retain screws for installation of replacement oxygen sensor board.

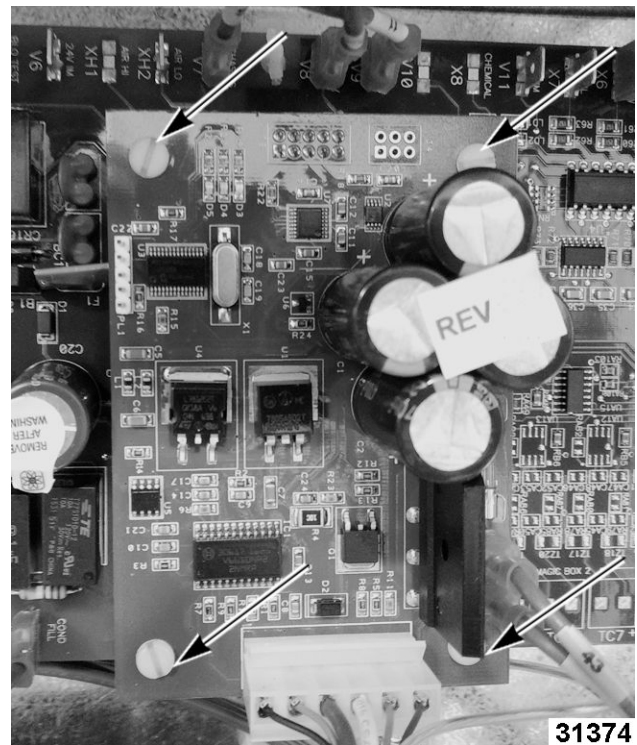

Fig. 24

NOTICE

Oxygen sensor board must be installed while unit is **unplugged**. Failure to install while unit is **unplugged** will cause permanent damage to oxygen sensor board.

Installation of Oxygen Sensor Board.

1. Verify oxygen sensor board holes line up with the main control board standoffs.

NOTICE

Verify electrical connection between main board and oxygen board is secure by connecting 10-pin female header on back side of oxygen board to 10-pin male header located on main control board.

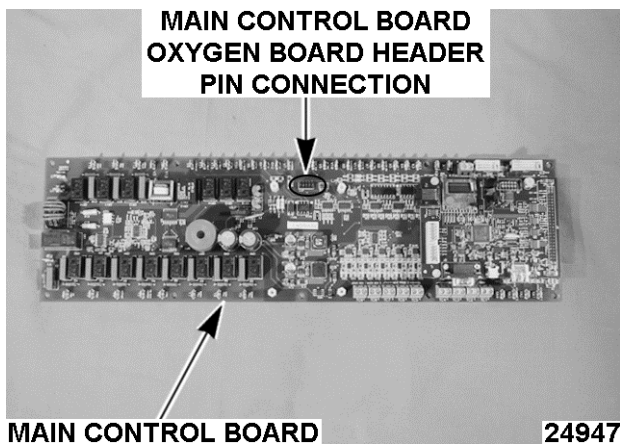

Fig. 25

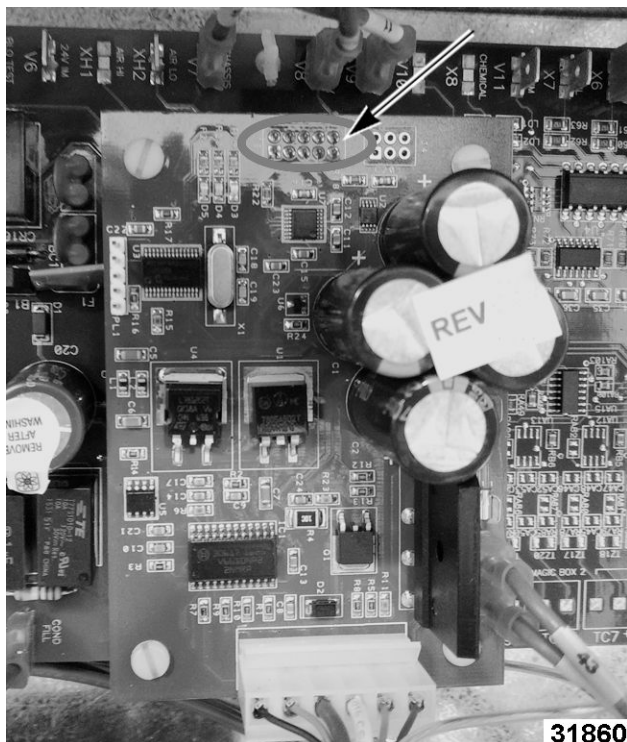

Fig. 26

2. Secure using screws from replaced board.
3. Power on unit.
4. Do not CALIBRATE OXYGEN SENSOR BOARD except at high altitude.
5. Check for proper operation.

NOTICE

Refer to SERVICE MODE (1963) and perform oxygen sensor test o1 through o5.

FERRITE



WARNING

Disconnect the electrical power to the machine and follow lockout / tagout procedures.

1. Remove RIGHT PANEL.
2. Lift ferrite clip with flat screwdriver (two places).



Fig. 27

3. Reverse procedures to install.

NOTE: Install ferrite approximately 3 inches from oxygen sensor board.

NOTE: Loop ferrite wires around the ferrite to keep ferrite in place.

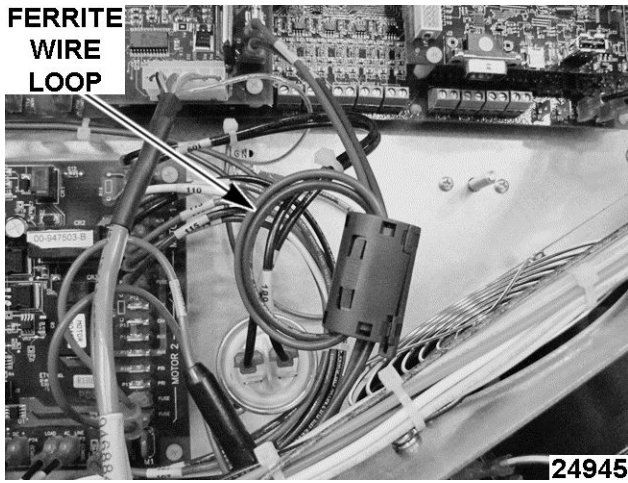

Fig. 28

MOTOR CONTROL BOARD



WARNING

Disconnect the electrical power to the machine and follow lockout / tagout procedures.

NOTICE

Certain components in this system are subject to damage by electrostatic discharge (ESD) during field repairs. An ESD kit is required to prevent damage. The ESD kit must be used anytime the circuit board is handled.

1. Remove RIGHT PANEL.
2. Note and disconnect electrical connections from board.
3. Remove motor control board nylon screws.

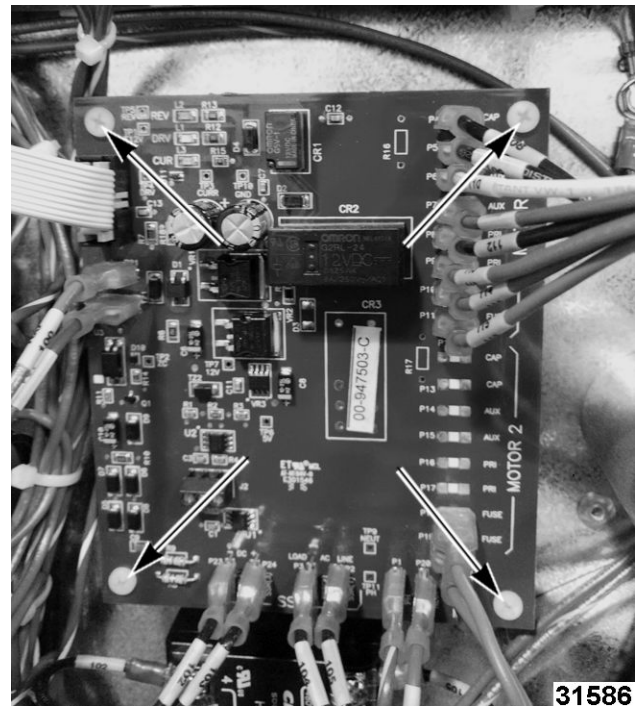

Fig. 29

4. Reverse procedure to install.
5. Check for proper operation.

CONTROL BOX COOLING FAN



WARNING

Disconnect the electrical power to the machine and follow lockout / tagout procedures.

1. Remove RIGHT PANEL.
2. Unplug two wires going to fan.
3. Remove screws securing fan to frame.
4. Check for proper air flow.
5. Reverse procedure to install.

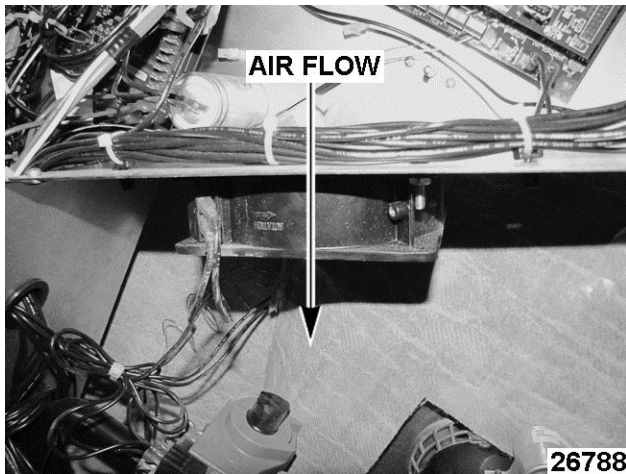

Fig. 30

CONTROL PANEL



WARNING

Disconnect the electrical power to the machine and follow lockout / tagout procedures.

NOTICE

Certain components in this system are subject to damage by electrostatic discharge (ESD) during field repairs. An ESD kit is required to prevent damage. The ESD kit must be used anytime the circuit board is handled.

Control Panel

1. Remove RIGHT PANEL.
2. Disconnect **P1** connector.



Fig. 31

3. Disconnect motor and control board ribbon cables.

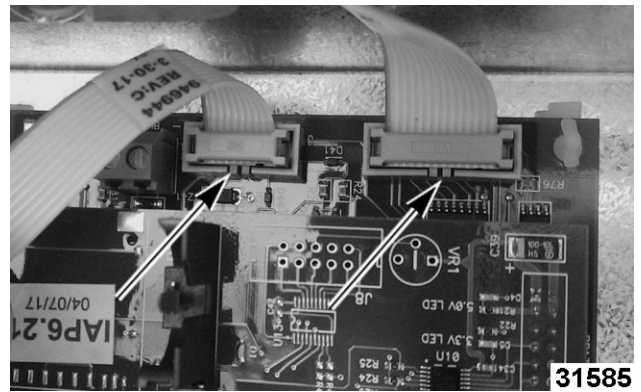

Fig. 32

4. Remove ribbon cable wire ties.

NOTE: Replace wire ties on install.



Fig. 33

5. Secure panel while removing six recessed control panel screws.

⚠ WARNING

Control panel could fall out of place as soon as screws are removed.

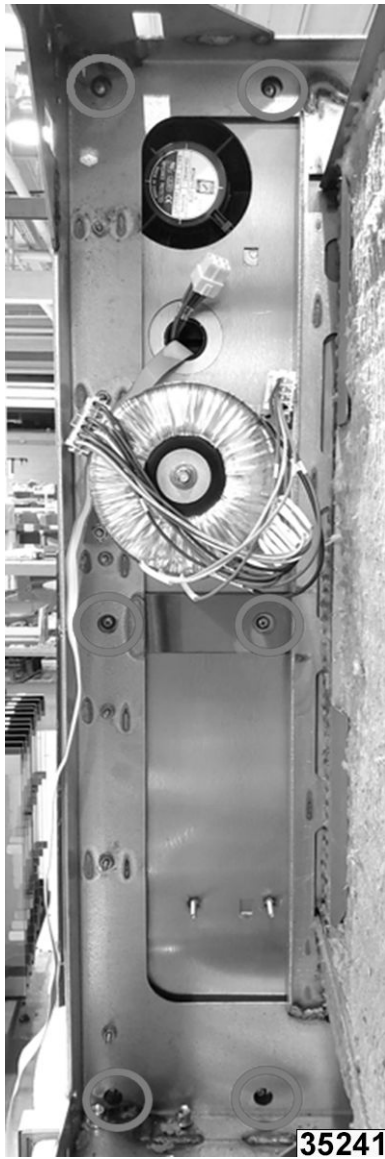

Fig. 34

6. Lift control panel up off hooks.

NOTE: Carefully pull connector and ribbon cable through hole when removing control panel.



Fig. 35

7. Place control panel on a clean, flat surface.
8. Place in secure location.

NOTICE

Do NOT place control panel flat on knobs. Doing so will cause damage to encoders.

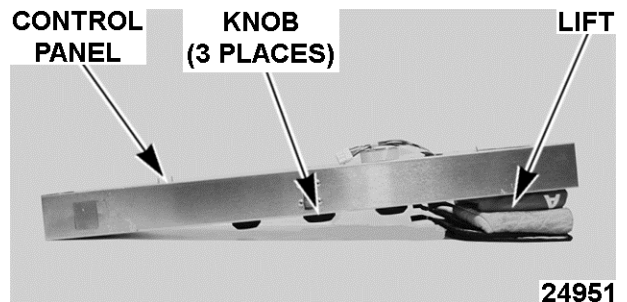

Fig. 36

9. Reverse procedures to install.

NOTICE

The door operation (latch, handle and sealing) can be negatively affected any time the control panel has been moved for servicing. Verify door latch alignment with door by opening and closing door when Control Panel is loosely mounted **AND** when securely mounted. If door is not operational, perform DOOR TO CONTROL PANEL ALIGNMENT.

NOTE: Motor control board ribbon cable will fit in J1 as well as J8, verify it is plugged into J1 on Main board.

10. Verify proper operation.

CONTROL PANEL COOLING FAN



WARNING

Disconnect the electrical power to the machine and follow lockout / tagout procedures.

NOTICE

Certain components in this system are subject to damage by electrostatic discharge (ESD) during field repairs. An ESD kit is required to prevent damage. The ESD kit must be used anytime the circuit board is handled.

Display Board Fan

1. Remove CONTROL PANEL from unit.
2. Place control panel in a secure location.
3. Remove screws from back of control base panel.



Fig. 37

4. Disconnect cooling fan wire connection.
5. Remove cooling fan nuts.

Previous Production Shown

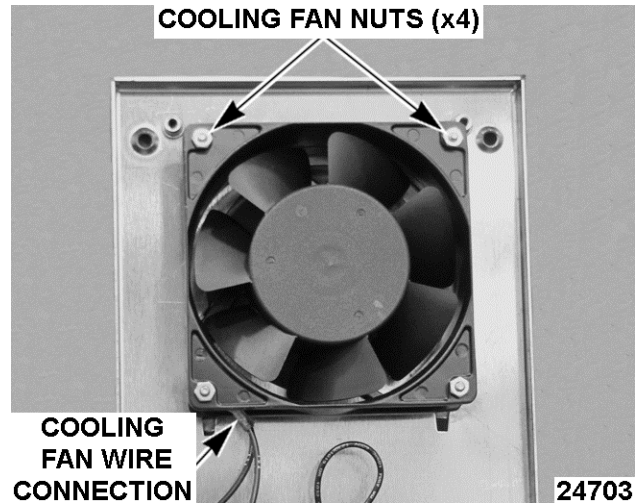

Fig. 38

6. Verify arrows are facing the correct direction when installed.

NOTE: Air to exhaust out of control panel.

Previous Production Shown

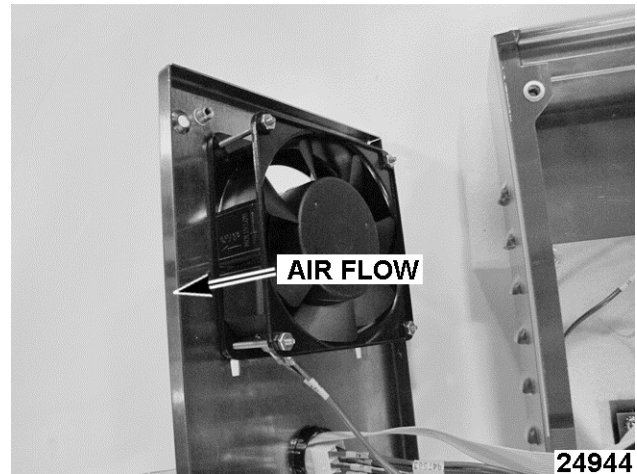

Fig. 39

7. Reverse procedure to install.
8. Check for proper operation.

NOTICE

The door operation (latch, handle and sealing) can be negatively affected any time the control panel has been moved for servicing. Verify door latch alignment with door by opening and closing door when Control Panel is loosely mounted **AND** when securely mounted. If door is not operational, perform DOOR TO CONTROL PANEL ALIGNMENT.

ON / OFF SWITCH



WARNING

Disconnect the electrical power to the machine and follow lockout / tagout procedures.

On / Off Switch

1. Remove CONTROL PANEL from unit.
2. Remove screws from back of control base panel.



Fig. 40

NOTE: Use care when removing back of control panel cover. Wires are attached.

NOTICE

Certain components in this system are subject to damage by electrostatic discharge (ESD) during field repairs. An ESD kit is required to prevent damage. The ESD kit must be used anytime the circuit board is handled.

3. Disconnect On/Off switch wires.

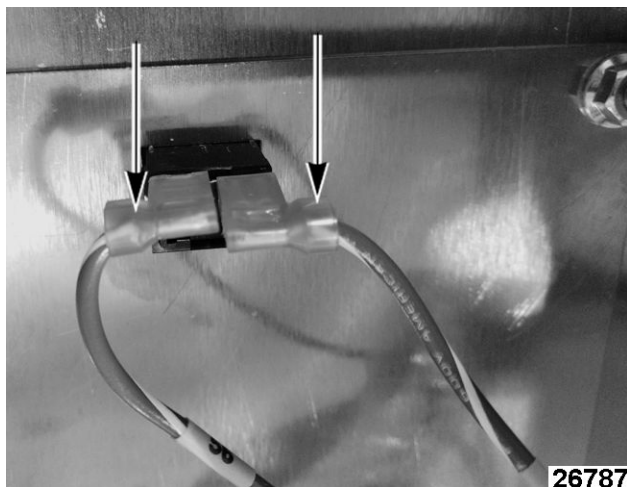

Fig. 41

4. Using a pair of channel locks, squeeze in the sides and press the switch out the front of the panel.
5. Reverse procedures to install.

NOTICE

The door operation (latch, handle and sealing) can be negatively affected any time the control panel has been moved for servicing. Verify door latch alignment with door by opening and closing door when Control Panel is loosely mounted **AND** when securely mounted. If door is not operational, perform DOOR TO CONTROL PANEL ALIGNMENT.

6. Check for proper operation.

KNOB & ENCODER



WARNING

Disconnect the electrical power to the machine and follow lockout / tagout procedures.

NOTICE

Certain components in this system are subject to damage by electrostatic discharge (ESD) during field repairs. An ESD kit is required to prevent damage. The ESD kit must be used anytime the circuit board is handled.

Control Knob & Encoder

1. Remove CONTROL PANEL.
2. Place control panel in a secure location.
3. Disconnect encoder ribbon cables.

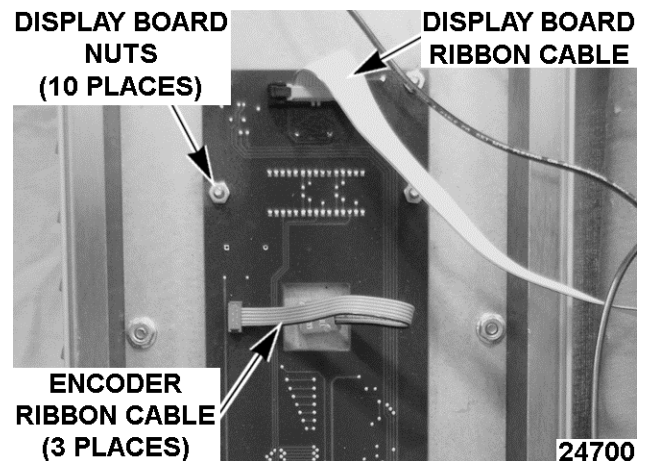

Fig. 42

4. Loosen set screw (1, Fig. 43) in tapped hole on knob.

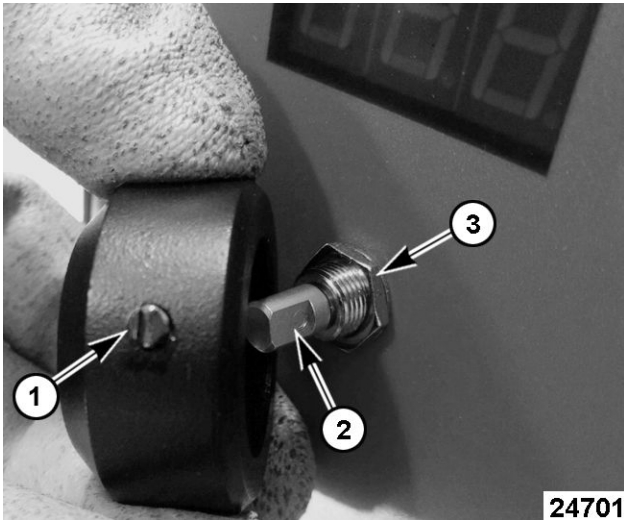

Fig. 43

5. Remove encoder nut (3, Fig. 43) to remove encoder.
6. Reverse procedures to install.

NOTE: Tapped hole needs to be aligned with flat part (2, Fig. 43) of encoder. Align tab in control panel hole needs to align with groove in encoder.

7. Check for proper operation.

NOTICE

The door operation (latch, handle and sealing) can be negatively affected any time the control panel has been moved for servicing. Verify door latch alignment with door by opening and closing door when Control Panel is loosely mounted **AND** when securely mounted. If door is not operational, perform DOOR TO CONTROL PANEL ALIGNMENT.

NOTE: Verify push button feature (ABCx-xxxxP devices only) is operable after knob is installed.

DISPLAY BOARD



WARNING

Disconnect the electrical power to the machine and follow lockout / tagout procedures.

NOTICE

Certain components in this system are subject to damage by electrostatic discharge (ESD) during field repairs. An ESD kit is required to prevent damage. The ESD kit must be used anytime the circuit board is handled.

Display Board

1. Remove CONTROL PANEL.
2. Remove screws from back of control base panel.

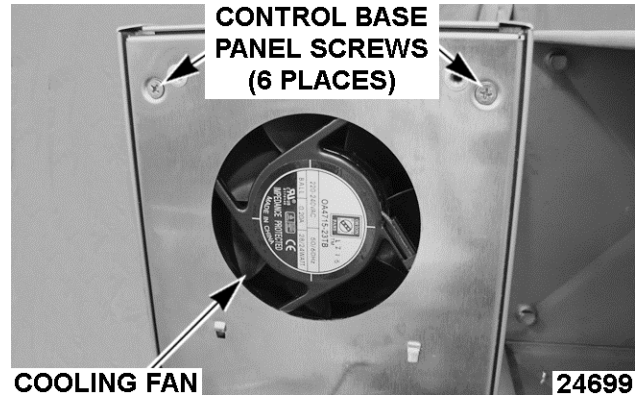

Fig. 44

NOTICE

Use care when removing back of control panel cover. Wires are attached.

NOTICE

Certain components in this system are subject to damage by electrostatic discharge (ESD) during field repairs. An ESD kit is required to prevent damage. The ESD kit must be used anytime the circuit board is handled.

3. Remove display board ribbon cable.
4. Remove encoder ribbon cables.
5. Remove display board nuts.

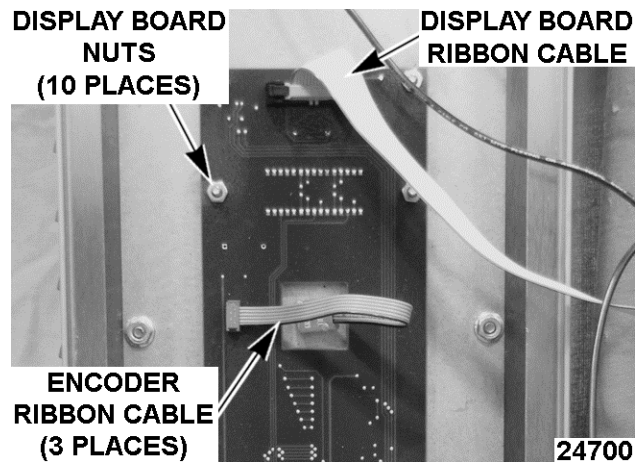

Fig. 45

6. On new display board, verify jumper J5 on back of display board is installed and on the correct two pins. Two closest to edge of the board.)

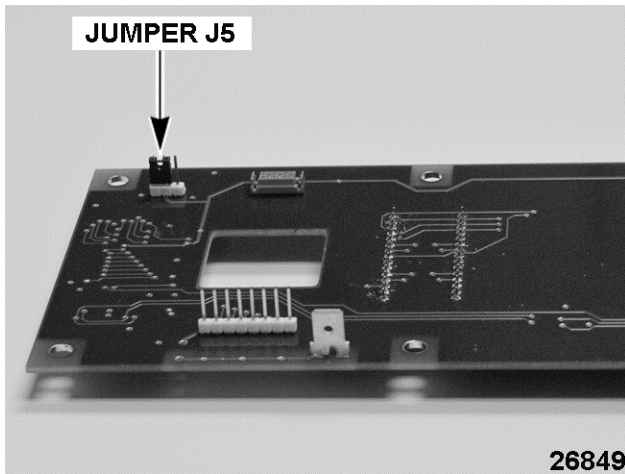

Fig. 46

7. Reverse procedures to install.
8. Check for proper operation.

NOTICE

The door operation (latch, handle and sealing) can be negatively affected any time the control panel has been moved for servicing. Verify door latch alignment with door by opening and closing door when Control Panel is loosely mounted **AND** when securely mounted. If door is not operational, perform DOOR TO CONTROL PANEL ALIGNMENT.

MEAT PROBE SOCKET



WARNING

Disconnect the electrical power to the machine and follow lockout / tagout procedures.

1. Remove RIGHT SIDE PANEL.
2. Disconnect probe socket from control board at TC2 connection (1, Fig. 47).

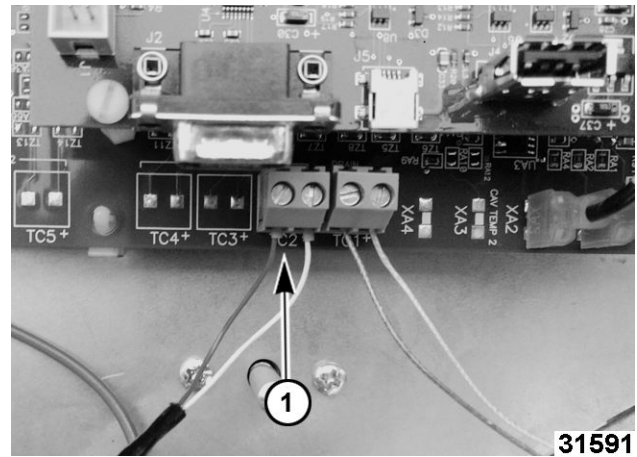

Fig. 47

3. Remove CONTROL PANEL.
4. Remove screws (1, Fig. 48), nuts (from behind), and probe socket from control panel.

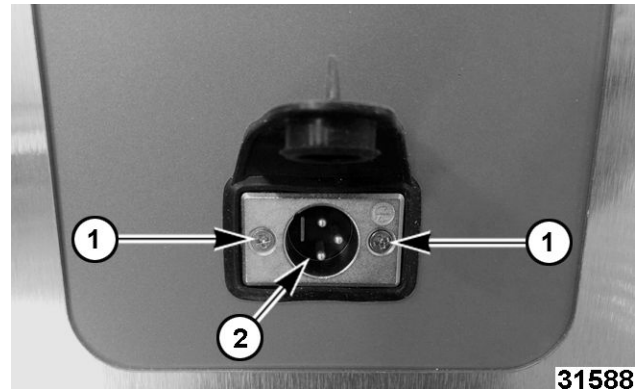

Fig. 48

5. Reverse procedure to install.
6. Align prongs (2, Fig. 48) as shown so meat probe (1, Fig. 49) plugs in with cord down.

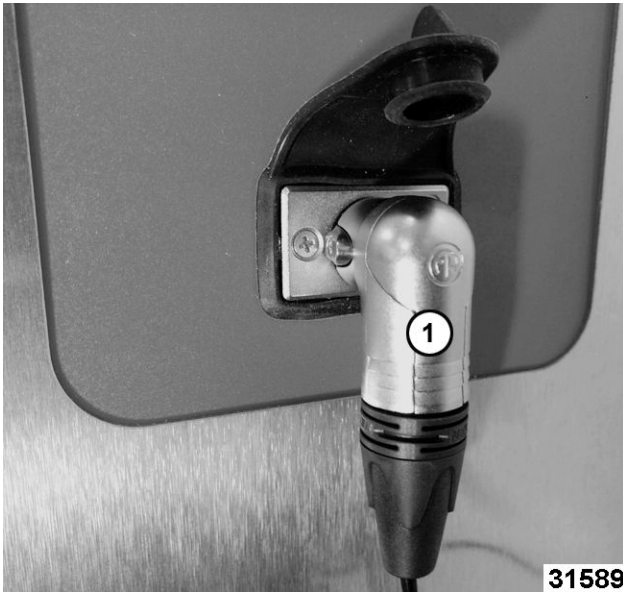

Fig. 49

7. Check for proper operation.

NOTICE

The door operation (latch, handle and sealing) can be negatively affected any time the control panel has been moved for servicing. Verify door latch alignment with door by opening and closing door when Control Panel is loosely mounted **AND** when securely mounted. If door is not operational, perform DOOR TO CONTROL PANEL ALIGNMENT.



Fig. 50

4. Check for proper air flow.
5. Reverse procedure to install.

REAR COOLING FAN



WARNING

Disconnect the electrical power to the machine and follow lockout / tagout procedures.

1. Remove RIGHT PANEL and REAR PANEL.
2. Remove two wires going to fan.
3. Remove nuts securing fan to frame.

Current Production Shown

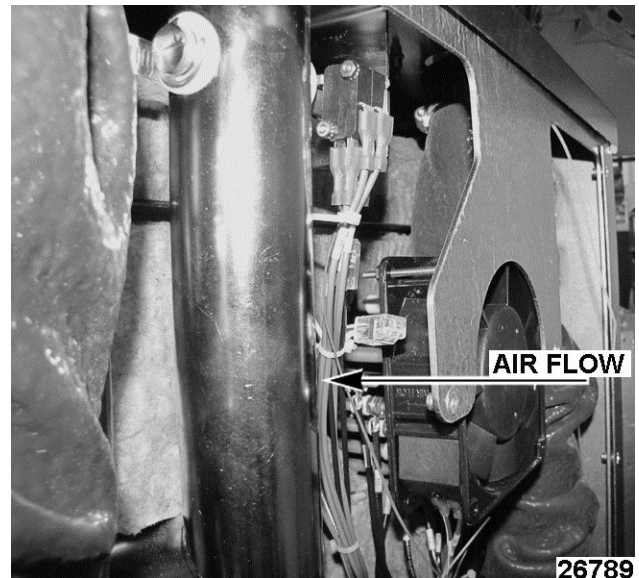

Fig. 51

HIGH-LIMIT THERMOSTAT



⚠ WARNING

Disconnect the electrical power to the machine and follow lockout / tagout procedures.

1. Remove High-limit thermostat screws.

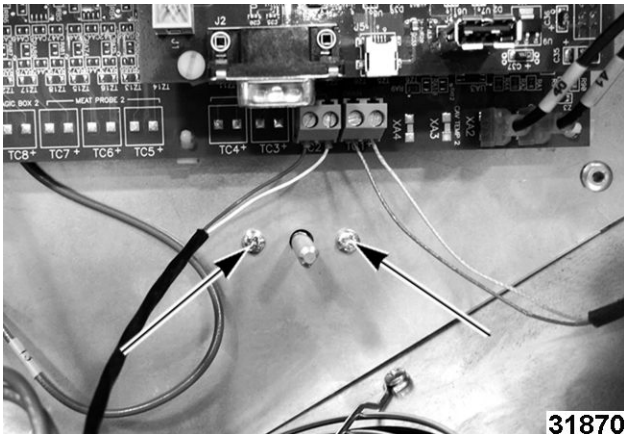

Fig. 52

2. Remove High-limit thermostat probe.

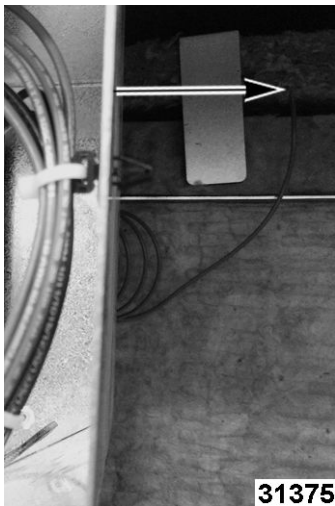
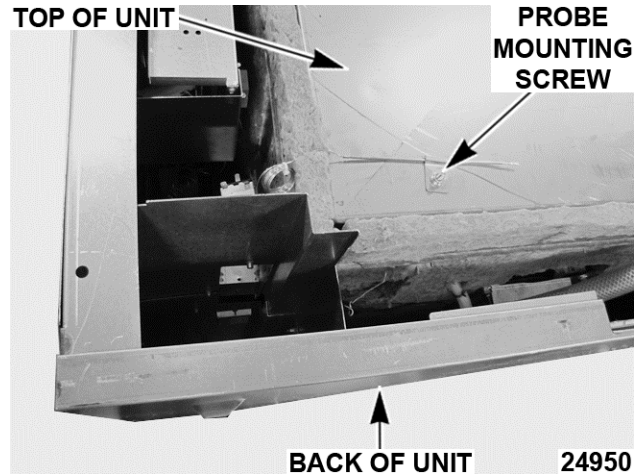

Fig. 53

NOTE: Top panel removed in photo (Fig. 54) for clarity. High-limit thermostat probe is located on top of unit, under insulation.

NOTE: Turn Probe Mounting Screw quarter turn to loosen. Do not remove probe mounting screw and bracket.



BACK OF UNIT
Fig. 54

3. Reverse procedures to install.

NOTE: When installing High-limit thermostat verify high-limit shaft is turned clockwise until it stops.

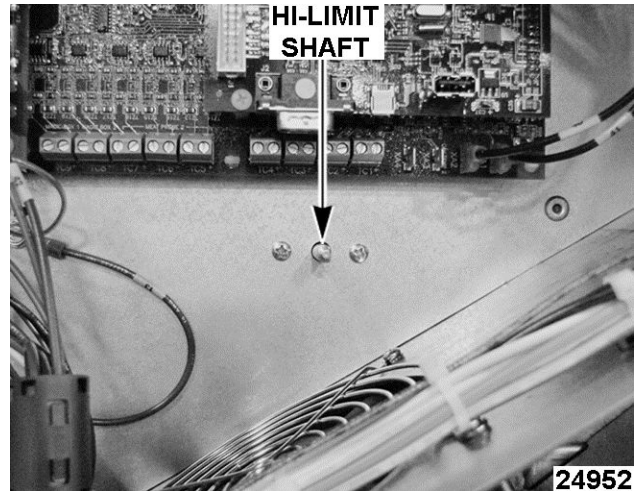

Fig. 55

4. Check for proper operation.

CAVITY INTAKE TUBE ASSEMBLY



⚠ WARNING

Disconnect the electrical power to the machine and follow lockout / tagout procedures.

1. Remove RIGHT PANEL and REAR PANEL.
2. On right side of unit, disconnect plug P3.

PREVIOUS GENERATION GAS OVEN

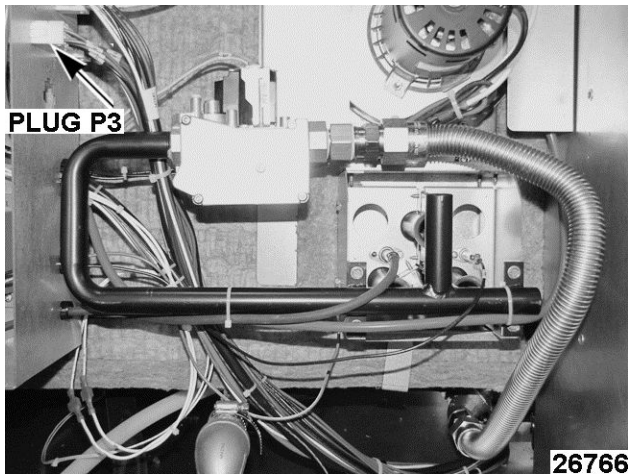

Fig. 56

3. Cut cable ties as needed to free wiring harness back to vent motor and switches.

NOTE: Note location of cable ties and wire routing. Vent motor and switch cables have a strain relief.

4. Remove motor shroud (1, Fig. 57).

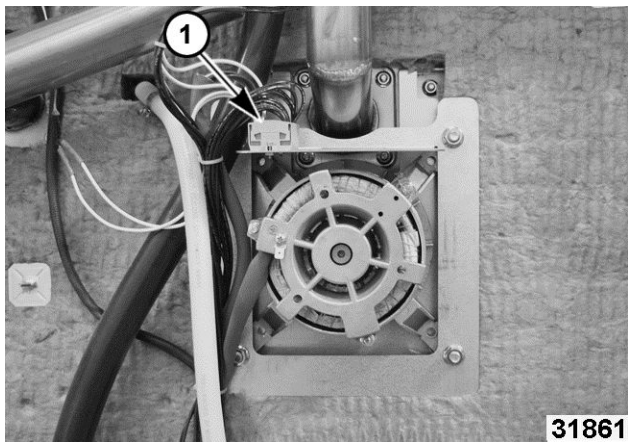

Fig. 57

5. Remove four nuts securing intake vent tube assembly to back of cavity.

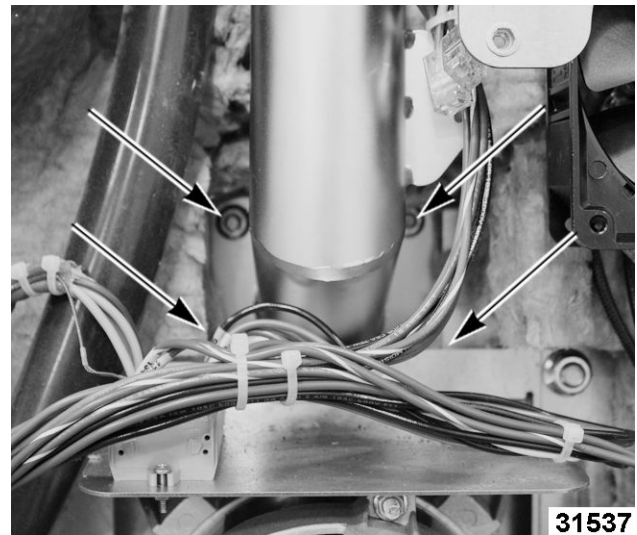

Fig. 58

6. Replace parts as needed.
7. Reverse procedure to install.

NOTICE

Torque cavity intake nuts to 24 in. lbs.

NOTE: There is a gasket between cavity intake tube and the cavity. This gasket should be replaced.

8. Check for proper operation.

CAVITY VENT MOTOR



WARNING

Disconnect the electrical power to the machine and follow lockout / tagout procedures.

1. Remove REAR PANEL.
2. Remove CAVITY INTAKE TUBE ASSEMBLY.
3. Rotate damper camshaft until set screw faces the rear of the cavity intake tube assembly.

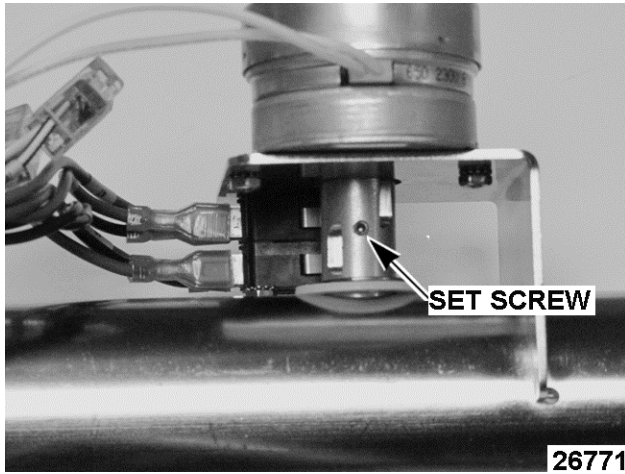

Fig. 59

4. Loosen set screw.
5. Remove two screws securing vent motor to the frame.
6. Pull motor free from assembly.
7. Insert blade of small screwdriver into wire nuts to release motor wires.

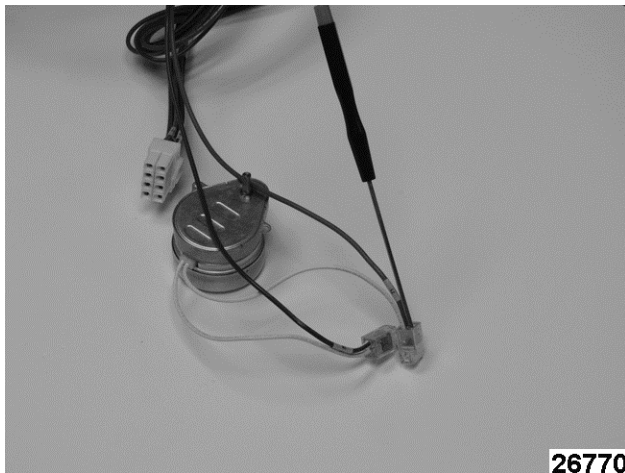

Fig. 60

- NOTE:** A small straight blade screwdriver (jeweler screwdriver) is needed.
- NOTE:** If a small screwdriver is not available, cutting the wires and using a standard wire nut is acceptable.
8. Reverse procedure to install.

NOTICE

When inserting new motor, ensure flat side of motor shaft faces the set screw.

NOTE: Note location of cable ties and wire routing. Vent motor and switch cables have a strain relief.

9. Check CAVITY VENT SWITCH TEST AND ADJUSTMENT.

10. Check for proper operation.

CAVITY VENT SWITCHES



WARNING

Disconnect the electrical power to the machine and follow lockout / tagout procedures.

1. Remove RIGHT PANEL and REAR PANEL.
2. Remove wires going to cavity vent switches.

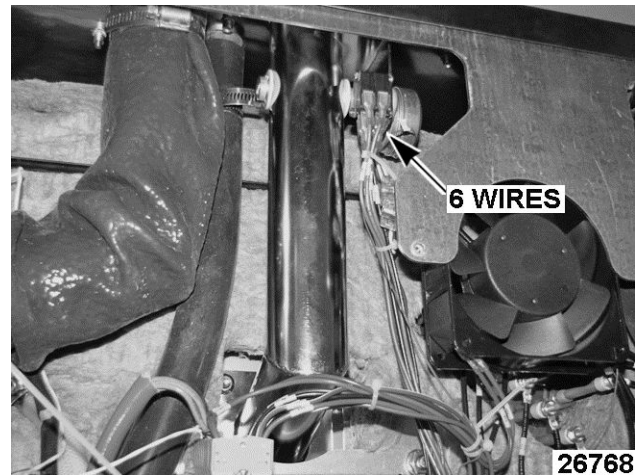

Fig. 61

3. Remove screws securing switches to frame.

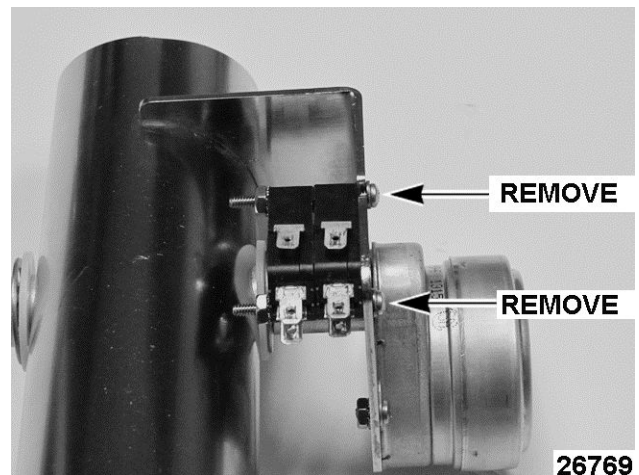

Fig. 62

4. Remove top screw and remove switches from frame.
5. Replace switch or switches as needed.
6. Reverse procedure to install.
7. Attach wires to switches.

NOTE: Note location of cable ties and wire routing. Vent motor and switch cables have a strain relief.

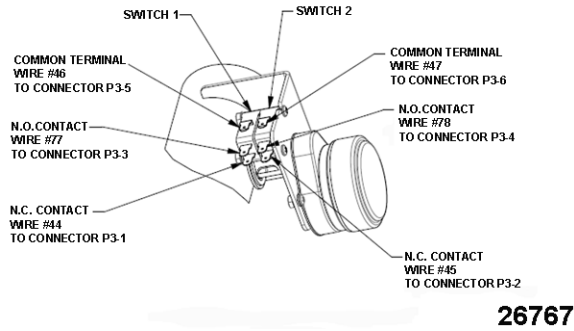

Fig. 63

8. Perform CAVITY VENT SWITCH TEST AND ADJUSTMENT.

TRANSFORMER



WARNING

Disconnect the electrical power to the machine and follow lockout / tagout procedures.

1. Remove RIGHT PANEL and REAR PANEL.
2. Disconnect plugs P7 (1, Fig. 64) and P8 (2, Fig. 64) going to transformer (3, Fig. 64).

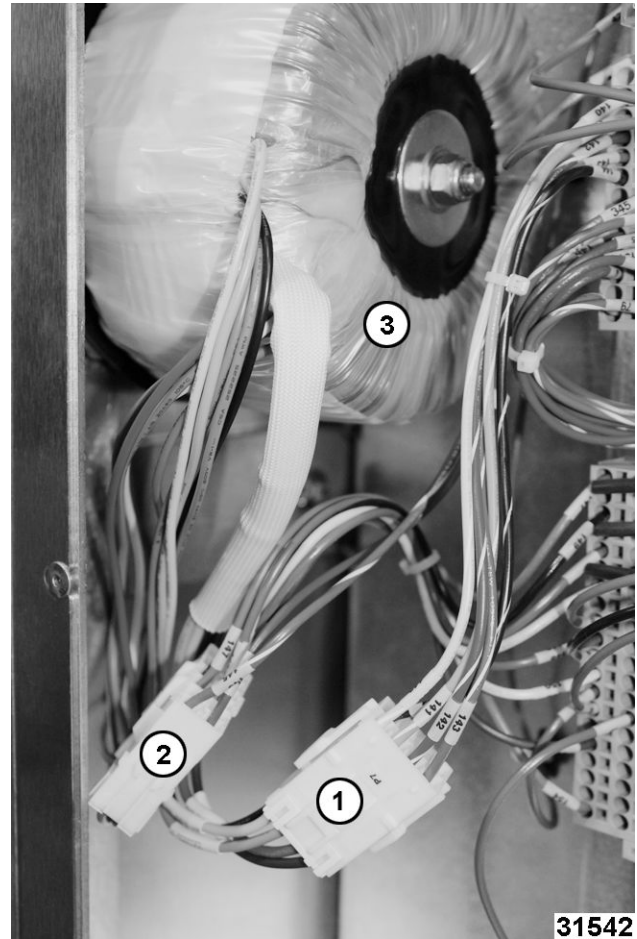

Fig. 64

3. Remove two nuts on left hand side of transformer bracket.

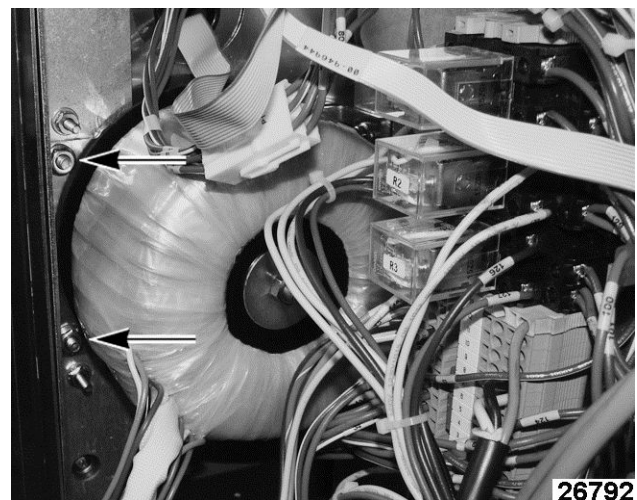

Fig. 65

4. Remove nut on the right hand side of transformer bracket.

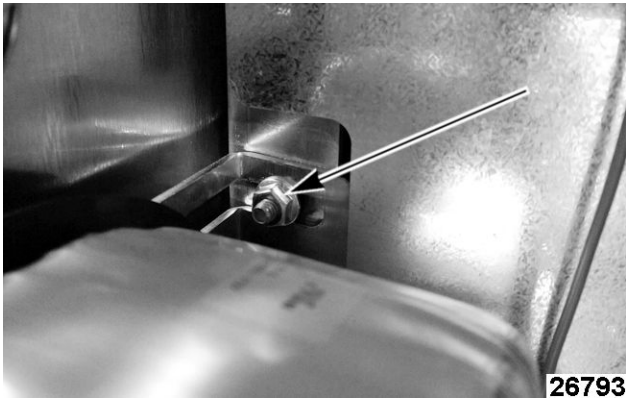

Fig. 66

NOTICE

Transformer weighs 12.5 pounds and has a strong magnetic pull to the frame of oven.

- Slide transformer off studs and down to the bottom of the oven.



Fig. 67

- Remove transformer and bracket from oven.
- Remove nut and both washers securing transformer to bracket.

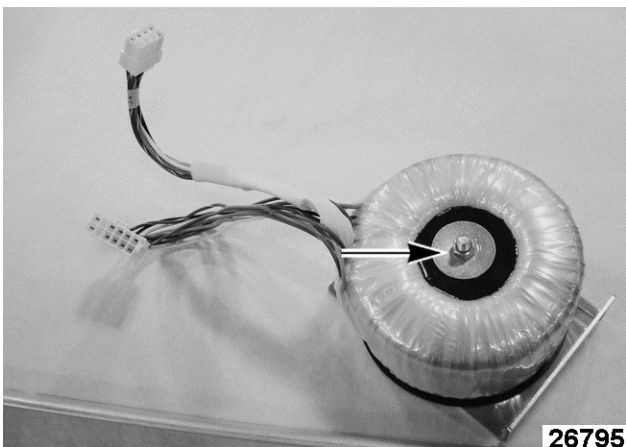

Fig. 68

- Replace transformer.
- Tighten nyloc nut to 75 in. lbs. to ensure transformer does not rotate loose.
- Reverse procedure to install.

TEMPERATURE SENSOR (RTD1)



WARNING

Disconnect the electrical power to the machine and follow lockout / tagout procedures.

- Remove RIGHT PANEL.
- Remove REAR PANEL.
- Remove all RTD wire ties.
- Remove black wire from TB2-3 and red wire from TB2-4.

NOTE: Insert small screwdriver in square next to the wire to release the wire from terminal block.

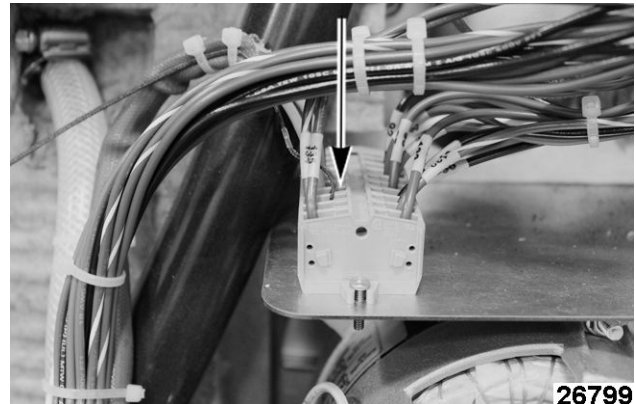

Fig. 69

- Remove OXYGEN SENSOR.
- Remove insulation.

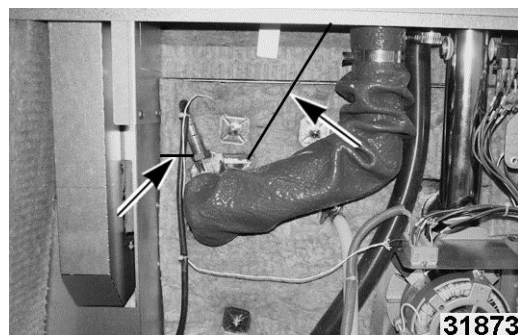

Fig. 70

- Cut outer layer of insulation.

- B. Pull upper insulation clip out and slide over out of the way.
- C. Spin square insulation clip holding outer layer.
- D. Carefully remove outer layer of insulation and set aside for reinstalling.
- E. Cut inner layer of insulation.
- F. Spin square insulation clip holding inner layer.
- G. Carefully remove inner layer of insulation and set aside for reinstalling.

7. Remove both RTD nuts.



Fig. 71

- 8. Remove temperature sensor RTD1 and gasket from unit.
- 9. Clean mounting surface.
- 10. Reverse procedure to install.

NOTICE

RTD wiring should exit straight out of insulation through special slot cut out in insulation and not pressed against oven cavity. Do not wire tie.

NOTICE

Verify insulation is tucked underneath upper insulation clip. Must replace insulation to prevent oven from overheating.

NOTE: Torque probe nuts at 10 in. lbs.

- 11. Check for proper operation.

DRAIN WATER CONDENSATE VALVE



WARNING

Disconnect the electrical power to the machine and follow lockout / tagout procedures.

- 1. Remove RIGHT PANEL and REAR PANEL.
- 2. Remove two screws securing valve to utility panel.



Fig. 72

- 3. Remove two wires going to valve.
- 4. Loosen hose clamp and pull valve free of hose.



Fig. 73

- 5. Replace valve.
- 6. Reverse procedure to install.

7. Check for proper operation.

DRAIN WATER THERMOCOUPLE



⚠ WARNING

Disconnect the electrical power to the machine and follow lockout / tagout procedures.

1. Remove RIGHT PANEL.
2. Loosen screws for terminal TC1 and remove wires.

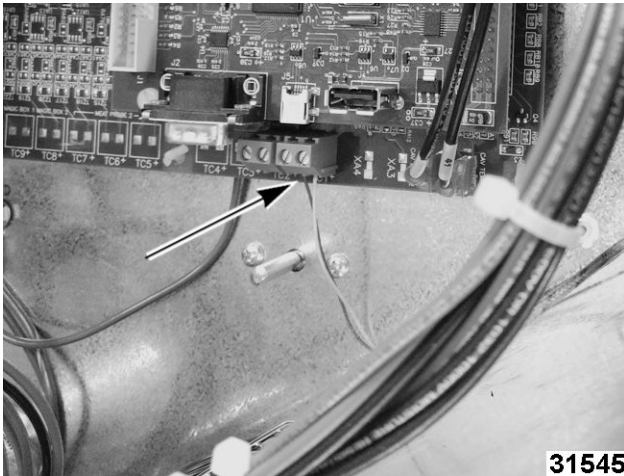

Fig. 74

3. Cut cable ties securing wires going to drain water thermocouple.

4. Loosen fitting that goes to drain.

1st Generation Production

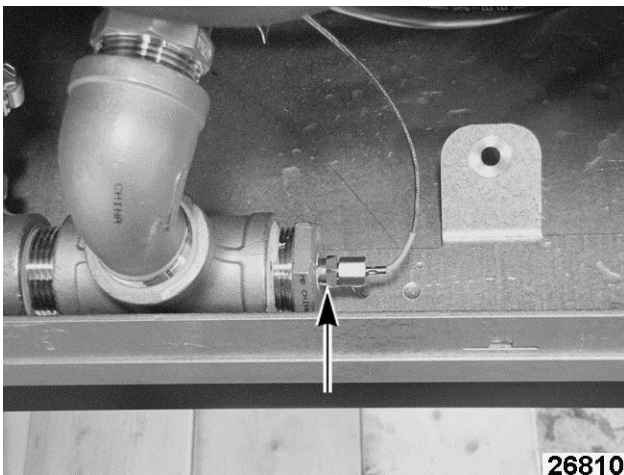

Fig. 75

2nd Generation Production

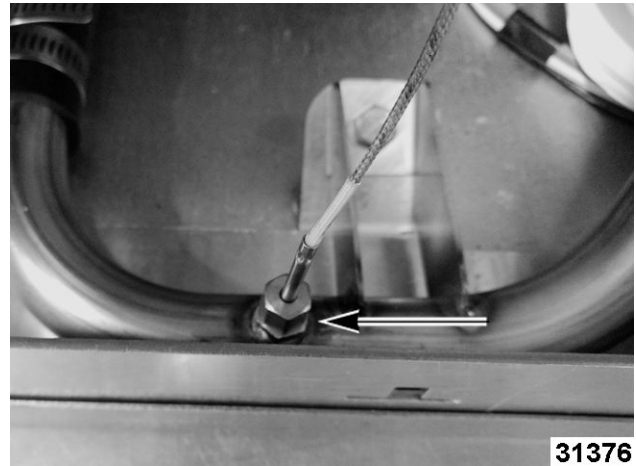

Fig. 76

5. Pull thermocouple from housing.

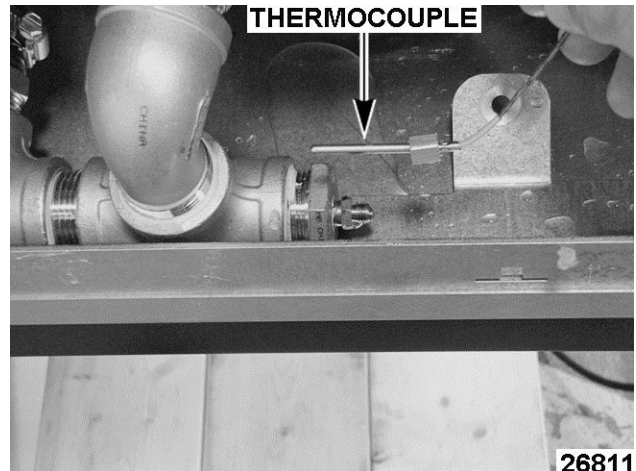

Fig. 77

6. Replace thermocouple ensuring the thermocouple is set to .800.

NOTICE

Thermocouple shown outside machine for clarity. Dimension of .800 should be met when thermocouple is installed.

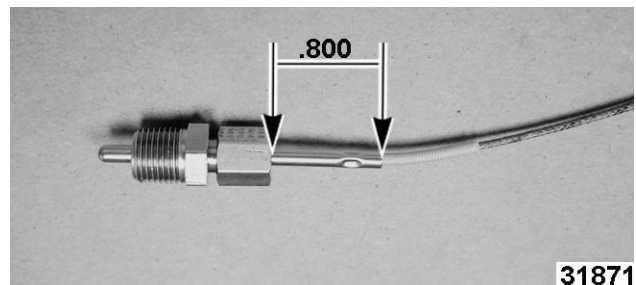

Fig. 78

7. Reverse procedure to install.

- Refer to CONFIGURATION MODE (1972) - GAS to check parameter P25, P26. based on drain type.

HUMIDITY VALVE



⚠ WARNING

Disconnect the electrical power to the machine and follow lockout / tagout procedures.

- Remove RIGHT PANEL and REAR PANEL.
- Remove screws securing humidity valve to utility panel.

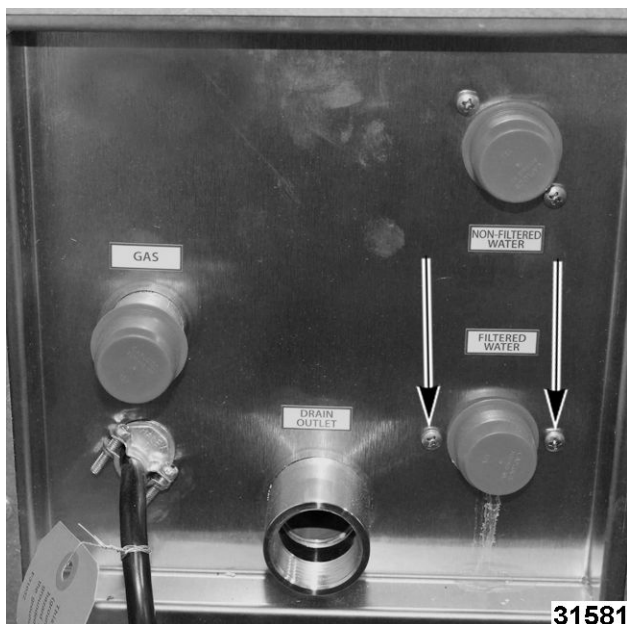

Fig. 79

NOTE: The humidity valve is a double valve.

- Remove two wires going to drain water condensate valve.

NOTE: This makes it easier to pull the humidity valve out from behind the utility panel.

- Remove the four wires going to humidity valve.

NOTE: Make sure to note which wire goes to which terminal.

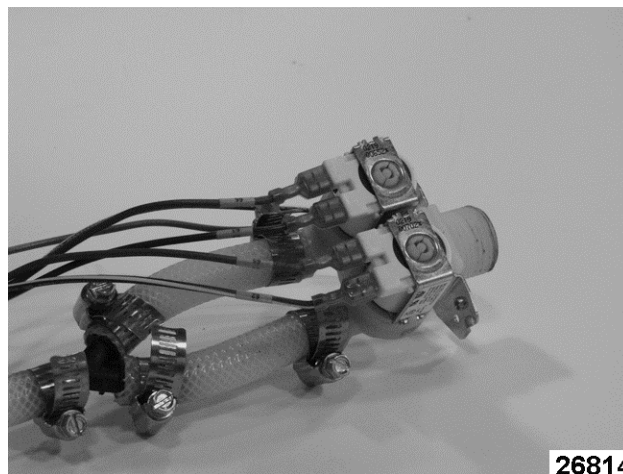

Fig. 80

- Loosen the two hose clamps securing the valve and free the valve from the two hoses.

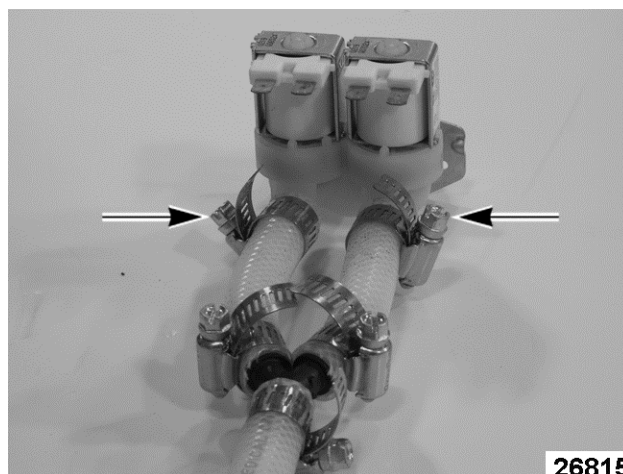

Fig. 81

- Replace valve.

NOTICE

Correct valve orientation prevents a water "stuck on" condition. Verify water valve tubes are on top and electrical connections are on bottom when installing.

- Reverse procedure to install.

CONVECTION FAN BAFFLE

⚠ WARNING

The oven and its parts are hot. Use care when operating, cleaning or servicing the oven.

- Remove all oven racks (1, Fig. 82).

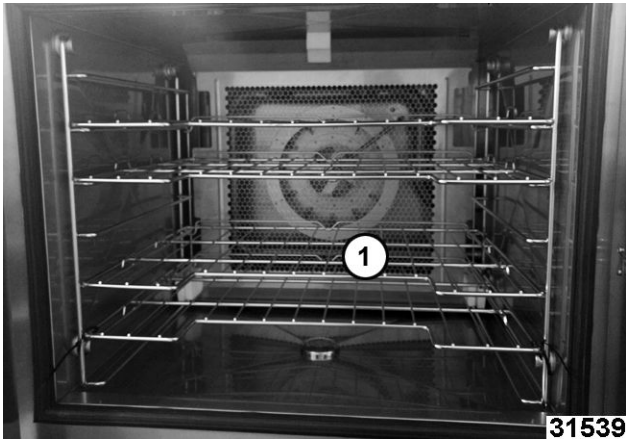

Fig. 82

2. Remove left and right rack guides (1, Fig. 83).

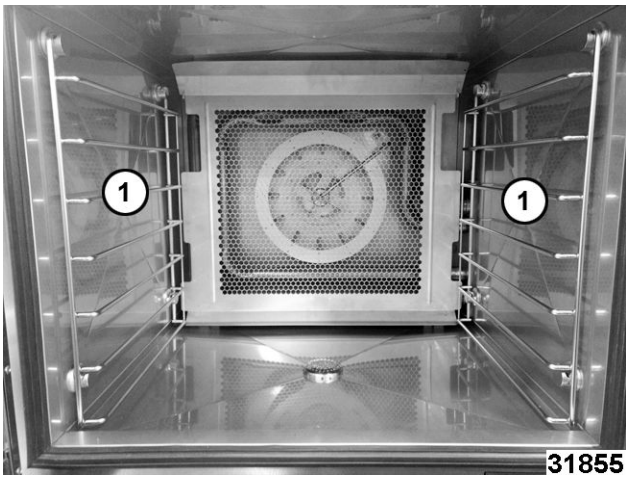

Fig. 83

3. Lift baffle (1, Fig. 84) up off bottom baffle support guides (Fig. 85).
4. Lift baffle over bottom rack guide hangers (2, Fig. 84).
5. Lift baffle up off top baffle hangers (Fig. 85).

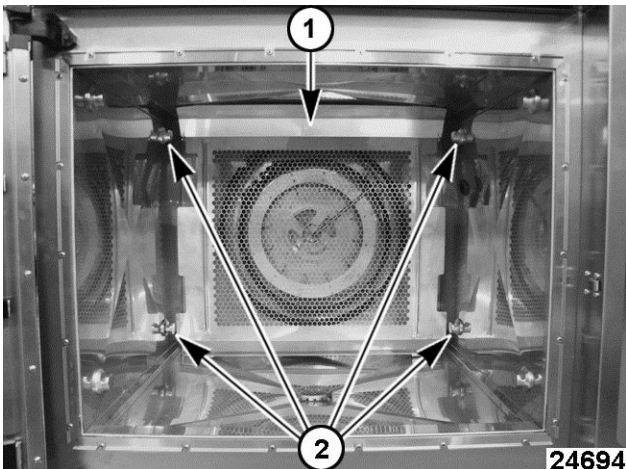

Fig. 84

6. Pull towards front of oven to remove.
7. Reverse procedures to install.

NOTICE

Verify convection fan baffle is hooked on top panel and supported behind bottom baffle support guides.

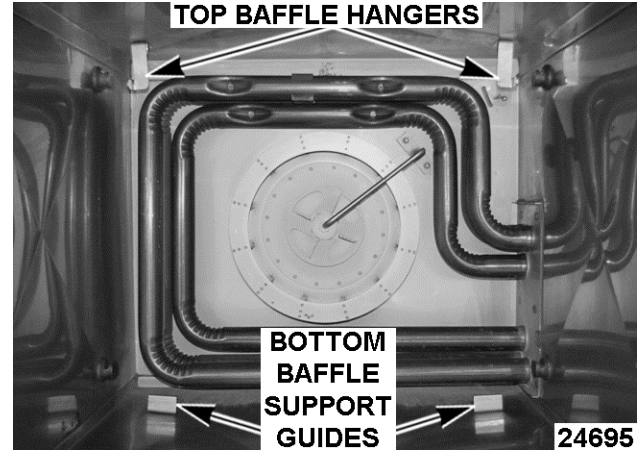

Fig. 85

CONVECTION FAN MOTOR

NOTICE

Certain components in this system are subject to damage by electrostatic discharge (ESD) during field repairs. An ESD kit is required to prevent damage. The ESD kit must be used anytime the circuit board is handled.



WARNING

Disconnect the electrical power to the machine and follow lockout / tagout procedures.

NOTE: When using gear puller to remove convection fan, do not use factory stainless steel cap screw or damage to the screw head may occur. Use a spare M6 cap screw as listed under TOOLS.

Convection Fan

1. Remove RIGHT PANEL.
2. Remove REAR PANEL.
3. Remove humidity hose clamp (3, Fig. 86).

NOTE: Insulation removed from for clarity.

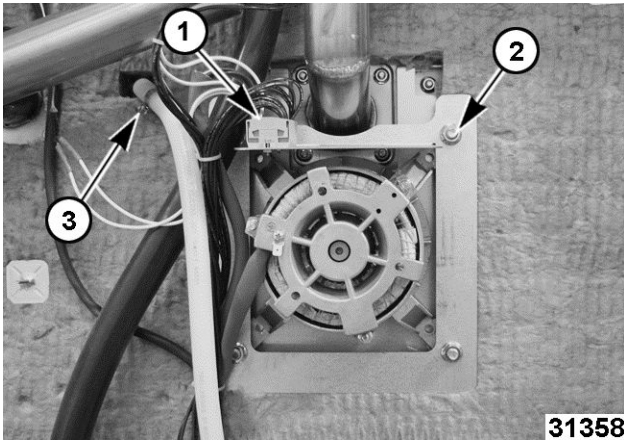

Fig. 86

4. Note and disconnect motor wires (1, Fig. 86).

Convection Fan Terminal Block (TB2) Connection Call-outs	
A	TB Block Number
White	10
Blue	9
Black	8
Red	7
Brown	6
Brown	5

NOTICE

Any wire ties removed during removal must be replaced during installation.

5. Remove nuts, shroud and spacers if they exist (2, Fig. 86).

NOTICE

Do not remove motor mounting nuts at this time.

6. Remove CONVECTION FAN BAFFLE.
 7. Remove humidity cavity nozzle nuts (Fig. 87) to rotate nozzle for clearance.

NOTE: Replace nozzle gasket if necessary.

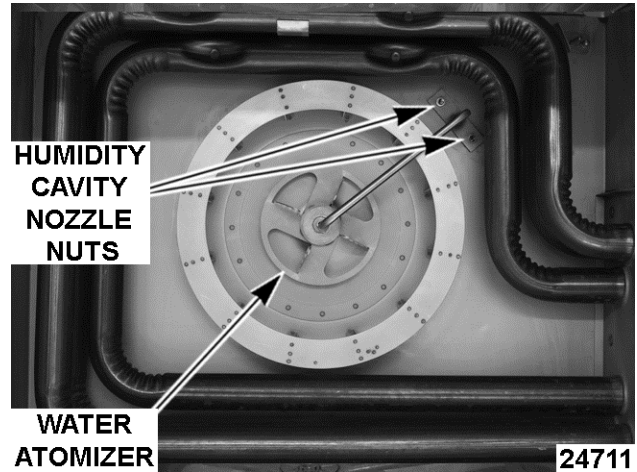

Fig. 87

8. Remove socket head cap screw.
NOTE: May need to apply heat for removal.

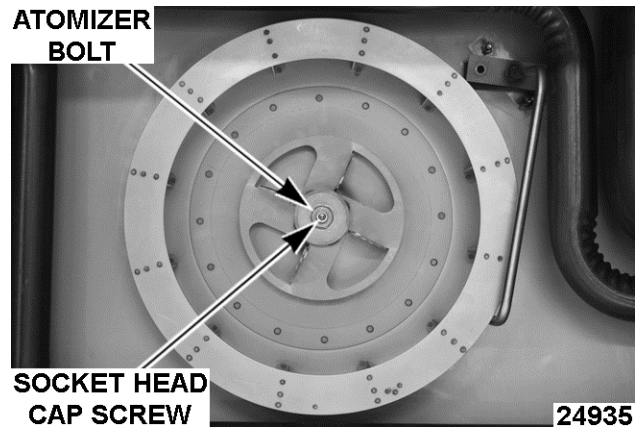

Fig. 88

9. Remove atomizer bolt (Fig. 88).
NOTE: Atomizer bolt is a left-handed bolt.
NOTE: May need to apply heat for removal.
 10. Remove water atomizer.
 11. Thread atomizer bolt into fan motor shaft. Leave approximately 1/8" space between hex head on atomizer bolt and fan hub.
 12. Insert spare M6 cap screw into fan motor shaft.
Hand tighten only.

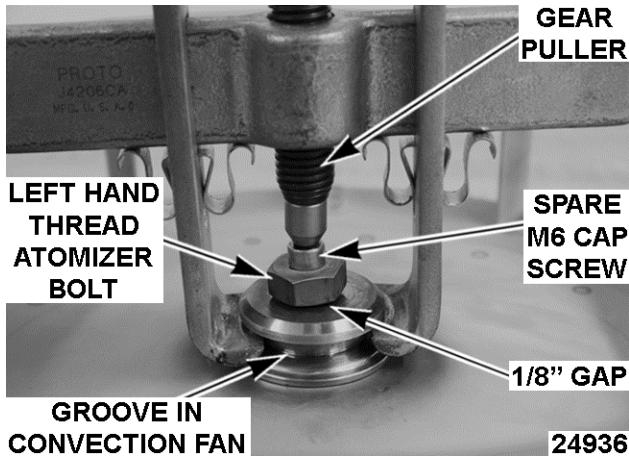

Fig. 89

13. Install gear puller.
14. Tighten gear puller to separate convection fan from motor shaft.

NOTE: Applying heat uniformly to groove in convection fan will assist with separation of fan and motor shaft.

15. Remove motor mounting nuts.
16. Reverse procedure to install.

NOTE: Verify motor wire orientation before installing.

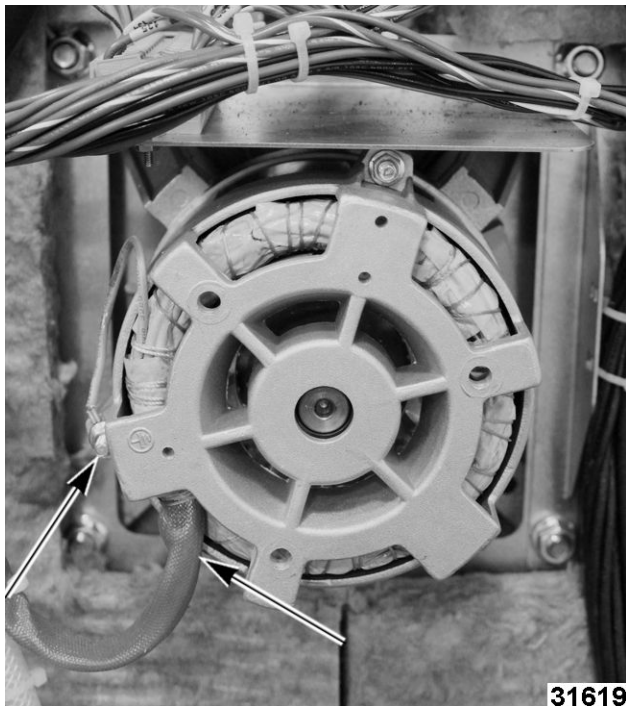

Fig. 90

NOTICE

Apply Loctite™ 272 to all torqued threads.

17. Set specific torques when installing.

- Torque motor mount nuts to 240 in. lbs.
- Torque atomizer bolt to 350 in. lbs.
- Torque atomizer socket head cap screw to 75 in. lbs.
- Verify atomizer nozzle is aligned with center of atomizer blade locking screw and torque nuts to 75 in. lbs.

NOTE: Tighten atomizer nozzle clamp after baffle, rack guides and racks are installed.

18. Check for proper operation.

GAS VALVE



WARNING

Disconnect the electrical power to the machine and follow lockout / tagout procedures.

NOTICE

Certain components in this system are subject to damage by electrostatic discharge (ESD) during field repairs. An ESD kit is required to prevent damage. The ESD kit must be used anytime the circuit board is handled.

1. Remove RIGHT PANEL.
2. Remove wires from gas valve.
3. Remove gas line from gas valve.
4. Remove high voltage ignitor cable from ignitor.
5. Remove flame sensor wire from flame sensor.
6. Remove manifold screws from burner.
7. Remove gas valve from manifold.

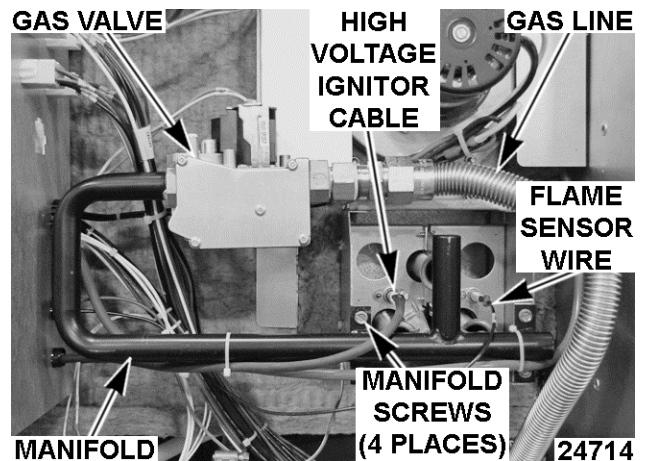

Fig. 91

8. Reverse procedures to install.

NOTE: Make sure the switch on gas valve is turned on.

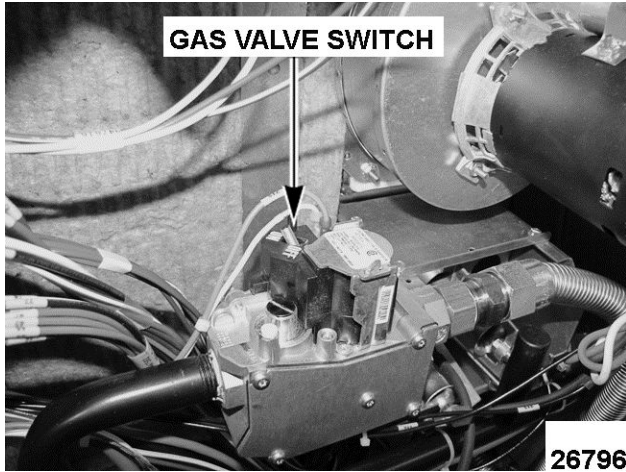

Fig. 92

9. Check for proper operation.

IGNITOR



⚠ WARNING

Disconnect the electrical power to the machine and follow lockout / tagout procedures.

Ignitor Removal

1. Remove RIGHT PANEL.
2. Disconnect high voltage cable from ignitor.

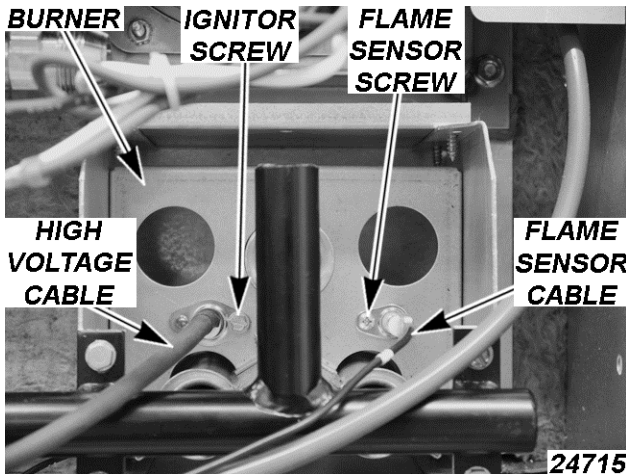

Fig. 93

3. Remove ignitor screw.
4. Pull ignitor to remove.
5. Reverse procedures to install.

NOTE: Verify high voltage cable is routed separately from flame sensor cable (wire 206) and ground wire (wire 205).

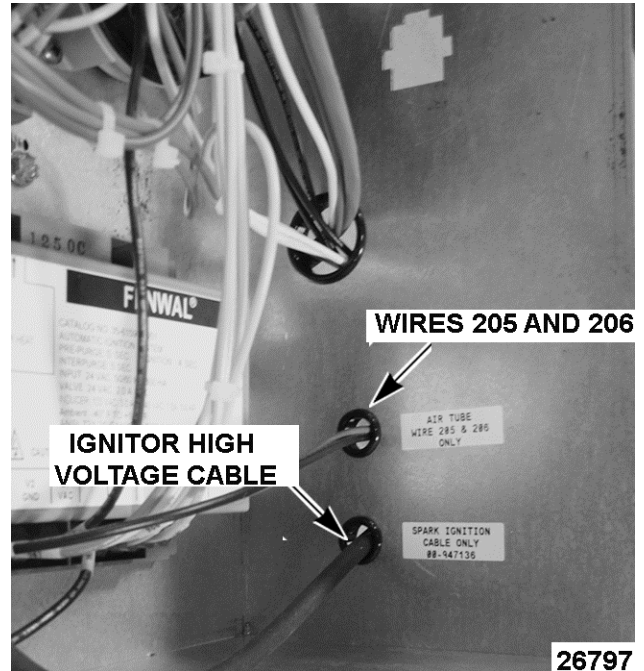

Fig. 94

6. Check for proper operation.

FLAME SENSOR



⚠ WARNING

Disconnect the electrical power to the machine and follow lockout / tagout procedures.

Flame Sensor Removal

1. Remove RIGHT PANEL.
2. Disconnect flame sensor cable (wire 206) from flame sensor.
3. Remove flame sensor screw.
4. Pull flame sensor to remove.

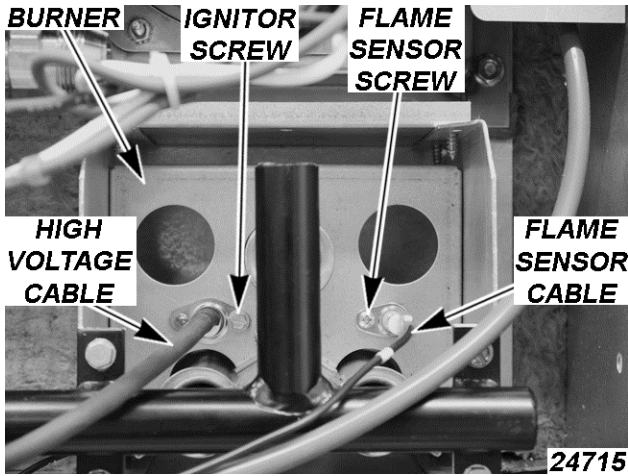

Fig. 95

5. Reverse procedures to install.

NOTE: Verify high voltage cable is routed separately from flame sensor cable (wire 206) and ground wire (wire 205).



Fig. 96

6. Check for proper operation.

INDUCER BLOWER



⚠ WARNING

Disconnect the electrical power to the machine and follow lockout / tagout procedures.

1. Remove RIGHT PANEL.

2. Remove REAR PANEL.
3. Disconnect inducer blower wires.

INDUCER BLOWER	WIRE HARNESS
BLACK	211 (Black)
WHITE	213 (White)
RED	212 (Red)

4. Remove motor shroud screws.
5. Lift up and towards front of unit to remove.

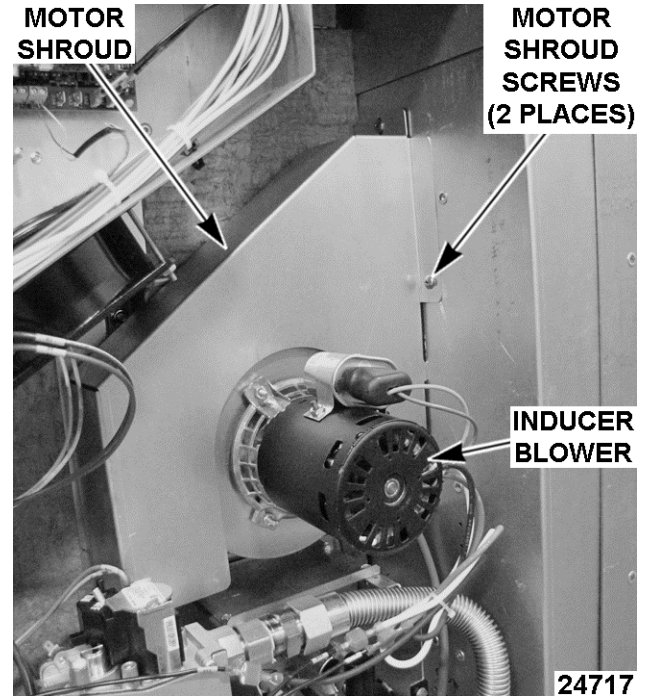

Fig. 97

6. Remove air pressure hose.

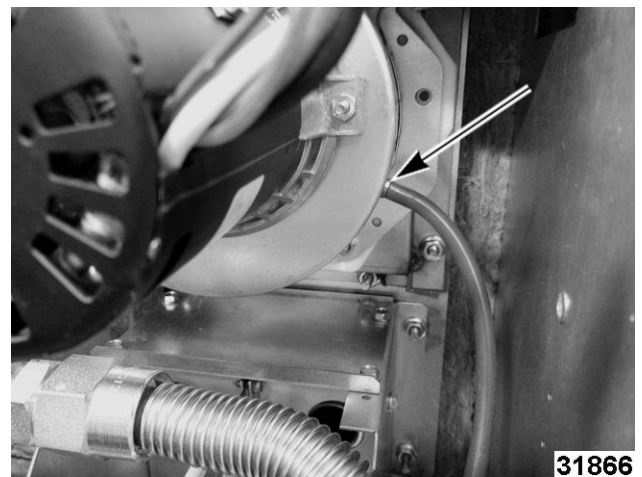

Fig. 98

7. Remove gas flue screws (1, Fig. 99).

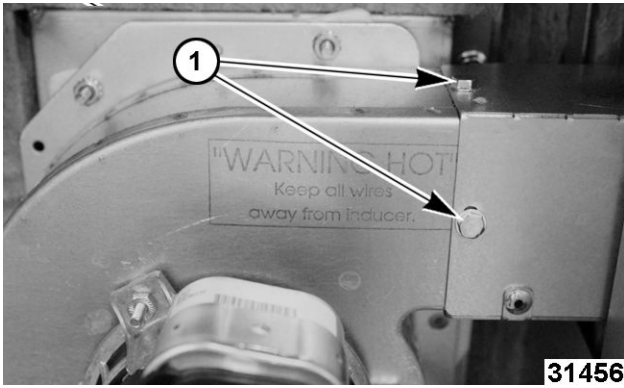

Fig. 99

8. Push gas flue (1, Fig. 100) back.



Fig. 100

9. Remove inducer blower assembly mounting nuts.

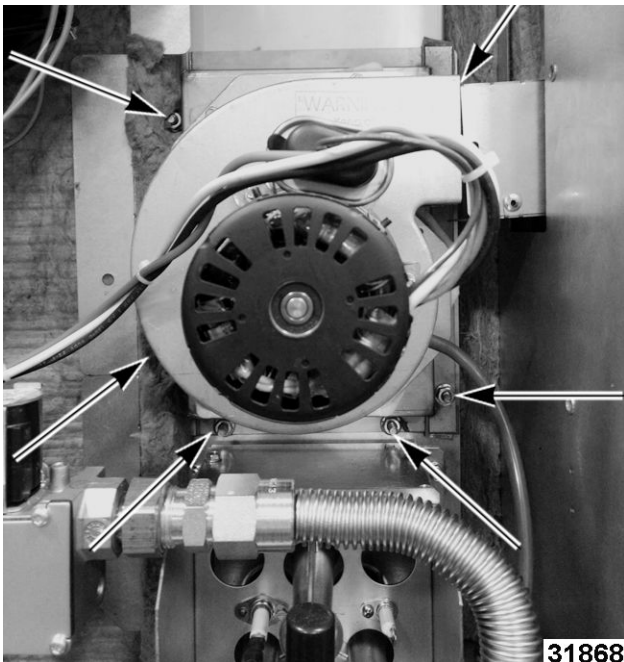

Fig. 101

10. Pull to remove inducer blower assembly.
11. Remove any excess inducer blower seal and clean surface before replacing seal.
12. Reverse procedures to install.
13. Check for proper operation.

HEAT EXCHANGER ASSEMBLY



⚠ WARNING

Disconnect the electrical power to the machine and follow lockout / tagout procedures.

1. Remove RIGHT PANEL.
2. Remove REAR PANEL.
3. Remove gas flue screws (1, Fig. 102) from blower.

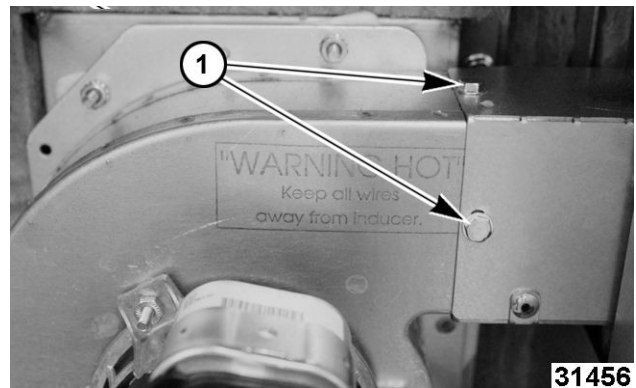

Fig. 102

4. Push gas flue (1, Fig. 103) back.



Fig. 103

5. Remove ignitor wire, flame sense wire, and air pressure hose (Fig. 104).

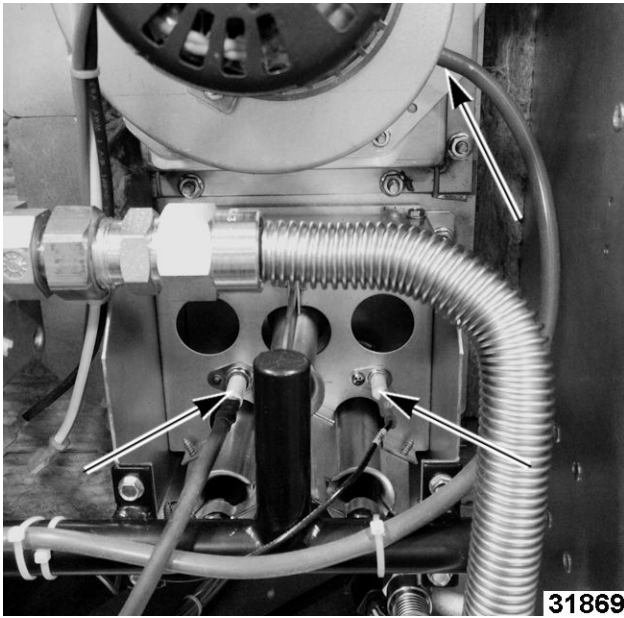

Fig. 104

6. Remove gas valve assembly mounting nuts.

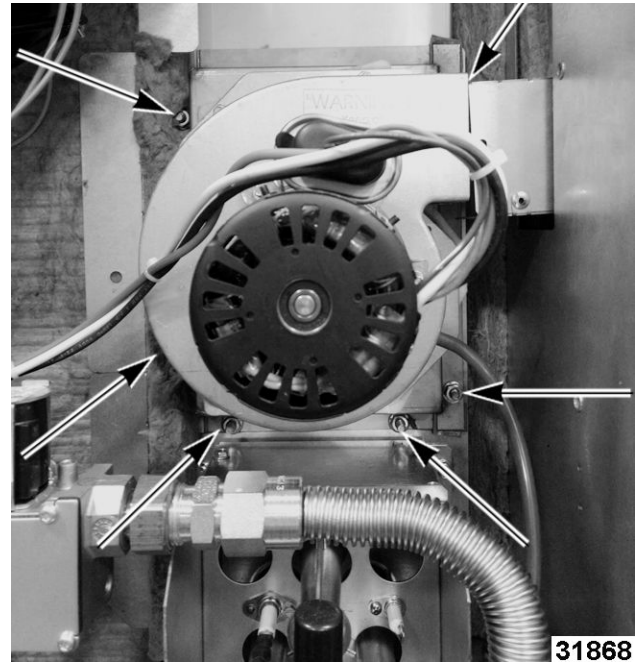

Fig. 106

8. Remove burner assembly mounting nuts.
Right Side

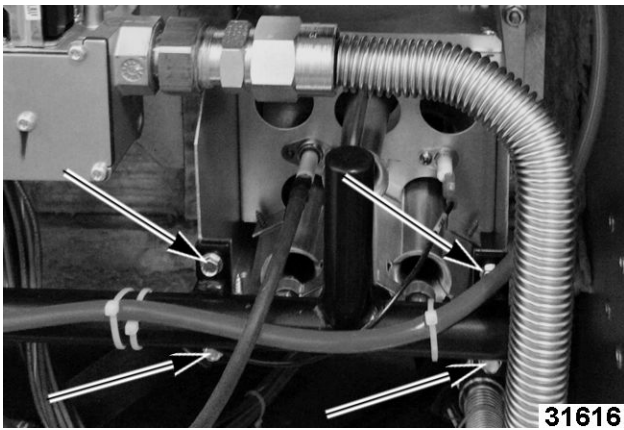

Fig. 105

7. Remove inducer blower assembly mounting nuts.

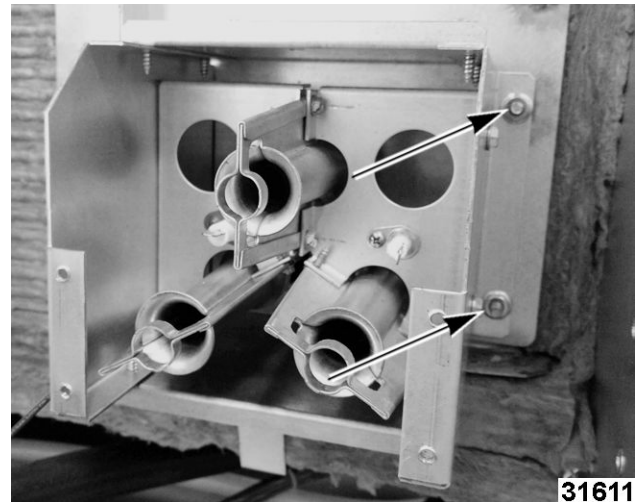

Fig. 107

Left Side

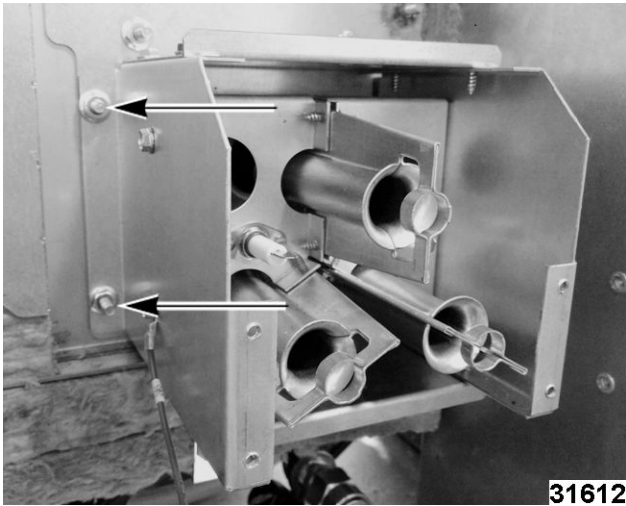

Fig. 108

9. Insert 2x4 board between heat exchanger and bottom of cavity.

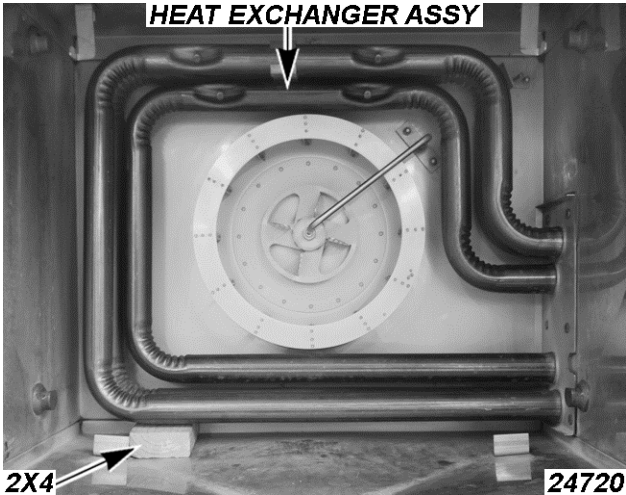

Fig. 109

10. Remove mounting plate nuts.

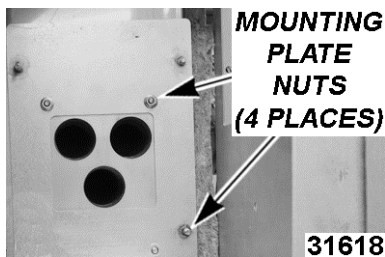

Fig. 110

11. Pull to remove heat exchanger from inside oven cavity. Remove any remaining gasket and clean surface.

NOTE: Check heat exchanger gasket for proper sealing.

12. Replace heat exchanger gasket.
13. Reverse procedure to install.

14. Torque nuts to 75 in. lbs.
15. Check for proper operation.

DRAFT INDUCER PRESSURE SWITCH



WARNING

Disconnect the electrical power to the machine and follow lockout / tagout procedures.

1. Remove RIGHT PANEL.
2. Remove leads from pressure switch.

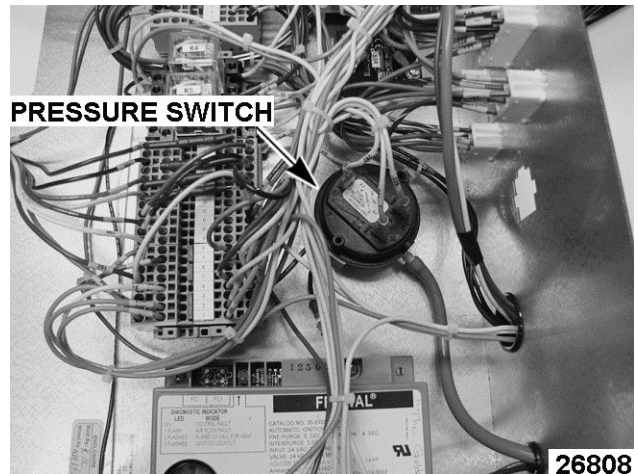

Fig. 111

3. Remove tube from pressure switch.
4. Remove screws and nuts securing pressure switch.
5. Reverse procedure to install.

IGNITION MODULE



WARNING

Disconnect the electrical power to the machine and follow lockout / tagout procedures.

1. Remove RIGHT PANEL.
2. Remove high voltage cable.

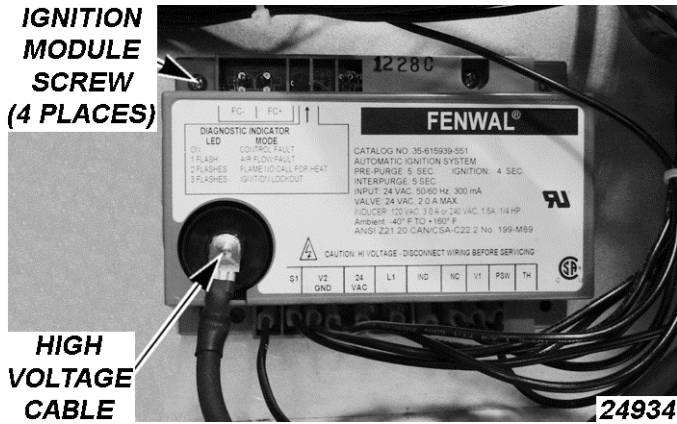

Fig. 112

3. Remove wires.

Ignition Module	Description	Wire Number
S1	Remote Flame Sensor	206
GND	System Ground	205
V2	Valve Ground	207
24VAC	24 VAC Supply	209
L1	120 VAC Input (hot)	203
IND	Inducer Blower (output)	204
NC	Alarm (normally closed contact)	225
V1	Valve Power (Output)	208
PSW	Pressure Switch Input	201
TH / W	Thermostat Input	200
FC+ FC-	Flame Current Test Pins	None

- Remove ignition module screws and nuts.
- Reverse procedure to install.

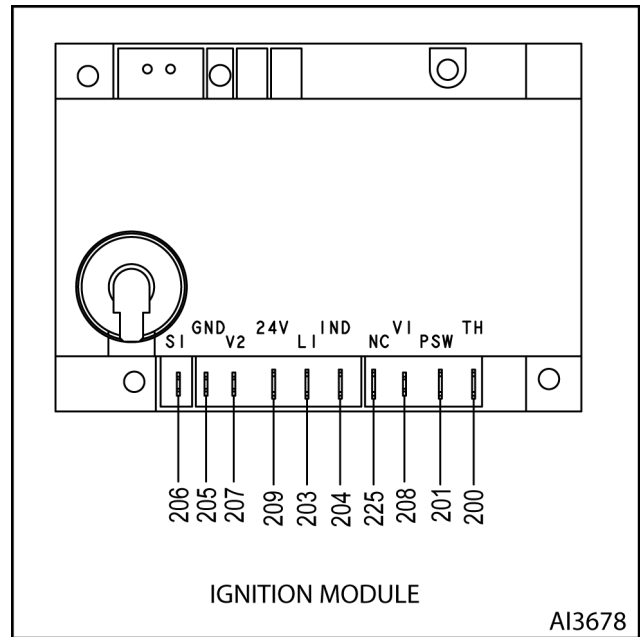

Fig. 113

NOTE: Verify high voltage cable is routed separately from flame sensor cable (wire 206) and ground wire (wire 205).

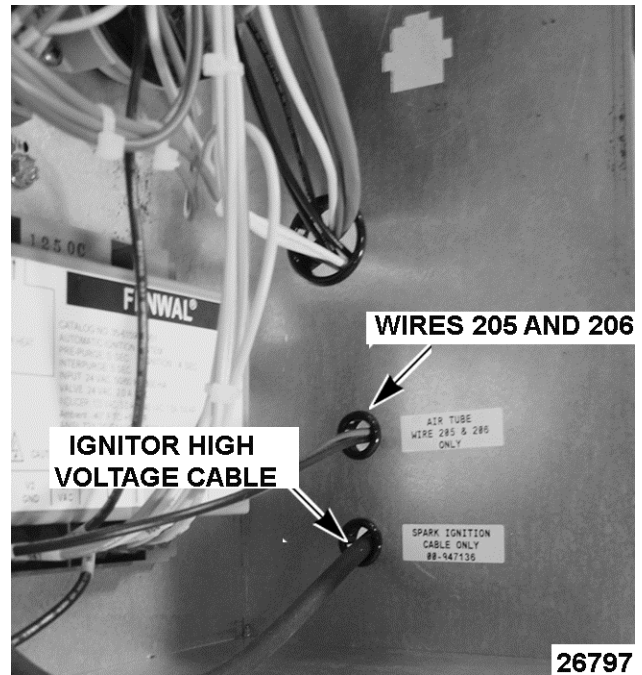

Fig. 114

6. Check for proper operation.

SERVICE PROCEDURES AND ADJUSTMENTS



⚠ WARNING

Certain procedures in this section require electrical test or measurements while power is applied to the machine. Exercise extreme caution at all times and follow Arc Flash procedures. If test points are not easily accessible, disconnect power and follow Lockout/Tagout procedures, attach test equipment and reapply power to test.

CONFIGURATION MODE (1972) - GAS

Log Into Configuration Mode 1972

1. Check with customer to verify settings have not been altered from factory settings.
2. Turn unit on.

NOTE: Oven must have no temp set to enter configuration.
3. Turn Timer knob counterclockwise until Timer display shows "set".
4. Turn Humidity knob counterclockwise until Humidity display shows "PAS".
 - A. Timer display will show "2000".
5. Turn Timer display counterclockwise to 1972.
 - A. Timer display will flash "1972".
 - B. Timer and Humidity display will flash twice.
 - C. Humidity display changes from "PAS" to "CFg" when logging into Configuration Mode.
 - D. Temperature Display will go to P0, which is the first configuration setting.

To review / change Configuration Mode 1972 settings

1. Turn the Temperature knob clockwise one step at a time, to go to the next configuration setting.

NOTE: Currently addresses P22, P30, and P31 are blank.
2. Presently P35 is the last address, the counter will continue to go higher, but the Time display and the Humidity display will be blank.
3. Turn the Humidity Knob to change the values as needed.
4. Refer to: "**Configuration Mode (1972) Settings**" chart below for options.

Logging out of Configuration Mode 1972

1. Turn Temperature knob counterclockwise until "---" displayed.

Configuration Mode (1972) Settings			
Temp. Display ("---")	Description	Time Display ("----")	Humidity Display ("---")
P0	Current firmware code revision (Month, day, year).	0424 (Month: 04, Day: 24)	17 (Year: 2017) Letter after number. = Revision within a date.
P1	Set temperature to Fahrenheit or Celsius.	UnIt	F or C
P2	Temperature knob increments. Temperature increment can be adjusted by 1, 5, or 10 degrees.	tInC	1, 5 , 10, 25
P3	Humidity knob increments. Humidity can be adjusted by 1 or 10 percent increments.	HInC	1 and 10
P4	Custom Operator Interface		Turn Hum knob between Factory (FACT) and Custom (CUST)
	Factory Default UI Setting	FACT	
	Custom UI Setting	CUST	
	NOTE: Operator can flip between P4 FACT and P4 CUST. Custom settings will be remembered. NOTE: Only when P4 is set to custom can settings in P5 and P6 be configured.		
P5	Define Temperature Selection in UI NOTE: Only when P4 is set to custom can settings in P5 and P6 be configured.	FACT	
		CUST (Indicates customer settings are currently loaded.)	SEt Turn knob to edit custom settings.
		ALL	oN TIP: Select "ALL on" to begin customizing if minimal changes needed to FACT settings.

Configuration Mode (1972) Settings			
Temp. Display ("---")	Description	Time Display ("----")	Humidity Display ("---")
		ALL	oFF TIP: Select "ALL oFF" if you want to start customizing from scratch.
		80 (min) 482 (max) Turn Timer knob through temperature choices.	oFF / on Hum knob can be toggled to change individual temperature on or off.
P6	Define Humidity Selection in UI NOTE: Only when P4 is set to custom can settings in P5 and P6 be configured.	FACT	
		80 (F) . . . 482(F) Turn Timer knob through temperature choices.	90 (% humidity) . . . 0 (%) Hum knob can be used to change humidity mapping to selected temperature.
NOTE: The following is an example of customizing the P4 through P6 settings.			
P4	P4 set to CUS _t Example 1. Toggle Hum knob to select CUS _t settings.	CUS _t	
P5	2. Turn Temperature knob to P5. 3. Toggle Hum knob oFF.	ALL	oFF
	4. Scroll timer knob to temperature of 212. 5. Toggle humidity knob to on.	212(F)	on
	6. Scroll timer knob to 325. 7. Toggle humidity knob to on.	325(F)	on
P6	8. Turn Temperature knob to P6.		
	9. Scroll timer knob to 325. 10. Toggle knob to 0%	212(F) 325(F)	100(%) 0(%)

Configuration Mode (1972) Settings			
Temp. Display ("---")	Description	Time Display ("----")	Humidity Display ("---")
	11. At completion, user interface is customized so user can only select 212F @ 100% or 325F @ 0%		
End of example.			
P7	Allows users to manual adjust humidity settings during operation.	HAdJ	on / oFF
P8	Oven Buzzer ON - Buzzer stops after 5 seconds. OFF - Buzzer turns on until door is opened or timer is turned off.	b 5	on / oFF
P9	Door Lights ON - Door lights flash at end of timer countdown. OFF - Door lights do not flash at end of countdown.	FLSH	on / oFF
P10	Batch Timer. Timer recalls last operated value when door is open and closed after buzzer. User does not need to reset timer. For example, User removes a batch of fries from oven and puts in a second batch of fries.	trCL	on / oFF
P11	Clean reminder. "CLn good bYE" shown when on/off switch is toggled off.	CLn	on / oFF
P12	Convection Fan Speed. • Non-adjustable: units without probe or units 8-11-14 FIRMWARE and prior. • Units with Probe only (adjustable). • 1400+ RPMs • 700-900-1250 RPMs • 525-700-900 RPMs NOTE: Speed selected for F1 must always be below F2.	F3	7
		Turn Timer Knob	
		F2	4-6
		Turn Timer Knob	
		F1	3-5
P13	Convection Fan Breaking Speed. (not adjustable)	F br	5
P14	Reversing fan timing. Number of minutes cavity fan turns before breaking and turning in opposite direction.	FrEU	Off, 2, 3, 4, 5
P15	Define maximum temperature knob setting in UI. Maximum temperature that can be set by user. Minimum setting limited by P16.	t_HI	80 thru 482 increments of 1, (450default).

Configuration Mode (1972) Settings			
Temp. Display ("---")	Description	Time Display ("----")	Humidity Display ("---")
P16	<p>Define minimum temperature knob setting in UI.</p> <p>Minimum temperature that can be set by user. Maximum setting limited by P15.</p> <p>NOTE: Must be less than P15.</p> <p>NOTE: Settings at P15 and P16 are only in effect if P4 is set to FACt.</p>	t_Lo	80 thru 482 increments of 1.
P17	<p>Cavity Automatic Steam Reduction: Reduces the cavity's steam build up before end of timed cook. Vent intake is opened "selected" seconds before end of timer countdown.</p> <p>NOTE: Steam reduction is not engaged mid-cook or during a "non-timed" cook when door opened.</p> <p>Example: P17 = 30 seconds (default). As the cook time counts down, the vent opens allowing the steam to dissipate.</p>	AUto	oFF, 30, 60, 90
P18	<p>Oven hour counter. Total hours oven has been cooking.</p> <p>Example: Timer: 0009, Humidity: 999 = 9,999 hours.</p> <p>NOTE: Counters will zero when Main I/O board is replaced.</p>	oVEn / 0009	HrS / 999
P19	<p>Humidity water counter. Total amount of water used to humidity oven in gallons.</p> <p>Example: Timer: 0009, Humidity: 999 = 9,999 gallons.</p> <p>NOTE: Counters will zero when Main I/O board is replaced.</p> <p>NOTE: Add P19 & P20 for total water usage.</p>	HUn / 0009	gAL / 999
P20	<p>Condensate tempering water counter. Total amount of water used to cool drain water in gallons.</p> <p>NOTE: Counters will zero when Main I/O board is replaced.</p> <p>NOTE: Add P19 & P20 for total water usage.</p>	Cond / 000	gAL / 00
P21	<p>External Meat Probe Thermocouple Calibration (temperature offset).</p> <p>Refer to EXTERNAL MEAT PROBE THERMOCUPLE TEMPERATURE CALIBRATION.</p>	<p>PCAL</p> <p>Turn Timer knob to view current calculated probe temp TC2 with P21 applied for ease of calibration.</p> <p>Example: 170(F)</p>	<p>Turn Humidity knob clockwise for positive offset or counterclockwise for negative offset.</p> <p>-10°F thru +10°F increments of 1</p> <p>Default 0</p>

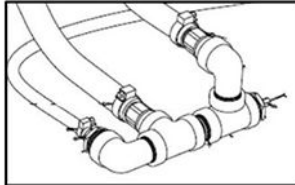
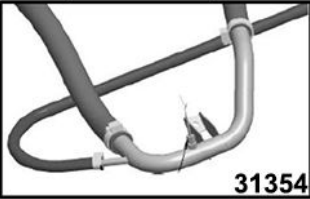
Configuration Mode (1972) Settings			
Temp. Display ("---")	Description	Time Display ("----")	Humidity Display ("---")
P23	<p>Demo Mode</p> <p>Used for sales. All functions operable except for heat.</p> <p>Disables critical errors.</p> <p>NOTE: Display will show "ABC trY it" after on/off switch is turned off.</p>	dEno	on
P24	<p>Temperature calibration (Temperature Offset)</p> <p>Refer to Temperature Calibration in Service Procedures and Adjustments.</p>	oCAL	<p>Turn humidity knob clockwise for positive offset, to lower overall cavity temperature.</p> <p>Turn humidity knob counter clockwise for negative offset, to raise overall cavity temperature.</p> <p>-15 thru 15 increments of 1.</p> <p>Default 0</p>
P25	<p>Condensate drain sensor activate temp.</p> <p>Temperature at which to run cooling water into drain trap to achieve the proper exit temperature of the drain water.</p> <p>NOTE: P25 and P26 are interdependent. The system requires P26 setting less than P25.</p> <p>Important: This parameter needs to be set based on drain type, not based on firmware revision.</p> <div style="display: flex; justify-content: space-around; align-items: center;"> <div style="text-align: center;"> <p>OLD (NPT Pipe Fittings)</p>  </div> <div style="text-align: center;"> <p>NEW (Bent Tube)</p>  </div> </div> <p style="text-align: center;">Fig. 115</p>	dron	<p>Tc1 =120 through 160 Increments of 1.</p> <p>140 (old drain, regardless of firmware revision)</p> <p>160 (new drain, regardless of firmware revision)</p>

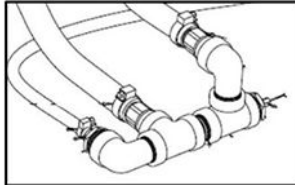
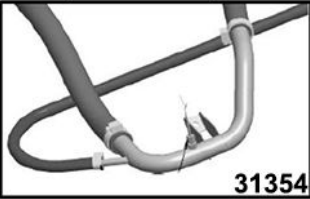
Configuration Mode (1972) Settings			
Temp. Display ("---")	Description	Time Display ("----")	Humidity Display ("---")
P26	<p>Condensate drain sensor deactivate temp. Temperature at which to stop cooling water into the drain trap to achieve proper exit temperature of drain water.</p> <p>NOTE: P25 and P26 are interdependent. The system requires P26 setting less than P25.</p> <p>Important: This parameter needs to be set based on drain type, not based on firmware revision.</p> <div style="display: flex; justify-content: space-around; align-items: center;"> <div style="text-align: center;"> <p>OLD (NPT Pipe Fittings)</p>  </div> <div style="text-align: center;"> <p>NEW (Bent Tube)</p>  </div> </div> <p style="text-align: center;">Fig. 116</p>	droF	<p>tC1 = 115 thru 155 increments of 1.</p> <p>130 (old drain, regardless of firmware revision)</p> <p>155 (new drain, regardless of firmware revision)</p>
P27	<p>Condensate tempering probe.</p> <p>Enabled: Tempering of drain water based on condensate probe temperature (Energy efficient). See P25 & P26.</p> <p>Disabled: Continuous time based tempering when in steam mode. (Less energy efficient.)</p>	StPr	EnA / d15
P28	<p>Additional Humidity knob operator interface.</p> <p>Enabled: Customer has option to turn humidity knob below 0, to a "---" setpoint. In this mode, vent is forced closed and no humidity water valve operation.</p> <p>Disabled: Humidity knob choices are set between 0 to 100%.</p>	AStn	EnA / d15
P29	User Interface (Push button functions) Cook-to-Probe & Fan Speed Control separately enabled/disabled.	P_UI	EnA/dIS
		Scroll Timer knob to	
P32	Oxygen board calibrate / zero. (Only recommended for high altitudes.)	F_UI	EnA/dIS
		ZEro	no Turning knob to "yes" indicates a multi-step procedure.
P33	<p>Oxygen Sensor Data</p> <p>Shown in % of Absolute Humidity. This value will not match the % Relative Humidity value shown on User Interface at oven cavity temperatures < 212°F.</p> <p>ONLY USED WHEN CALIBRATING OXYGEN SENSOR. (Refer to calibrating oxygen sensor board in service manual.)</p>	51	.2
		NOTE: Combine the two numbers to get 51.2%.	

Configuration Mode (1972) Settings			
Temp. Display ("---")	Description	Time Display ("----")	Humidity Display ("---")
P34	Humidification method (not adjustable). Disabled (default) allows for oxygen sensor based humidification at all humidity setpoints <100%. Enabled (future) employs a non-oxygen sensor based humidification method.	drIP	EnA/dIS
P35	Reset parameters to factory default values. To reset values to factory default: 1. Turn humidity knob clockwise to YES. Timer display flashes "----". 2. Turn timer knob clockwise to spell "rSET", one letter at a time. NOTE: Humidity display will read don, when the parameters have been reset. NOTE: This will reset P4,5,6 Custom settings.	rSET	no / YES don

CALIBRATING OXYGEN SENSOR BOARD

NOTICE

Oxygen sensor board needs to be calibrated when oven is installed at high altitude, otherwise do not calibrate.

1. Check oven temperature to verify oven temperature is below 100°F.
2. Open cavity door and keep open.
3. Towel dry cavity floor to ensure no standing water or steam in cavity.

NOTE: May need to remove racks to dry cavity floor.

4. Turn oven on and wait at least 3 minutes for sensor to warm up.
5. Log into Configuration Mode (1972).
6. Turn temperature knob clockwise to "P33".
 - Timer display should read between 0 and 24.
 - Humidity display should read between .00 and .99.

NOTE: If timer displays "----" when viewing P33, oxygen sensor is warming. Wait 3 minutes. When ready, Timer / Humidity display will change to a numeric value.

7. Turn temperature knob counterclockwise to P32.
 - Timer displays "ZEro".
 - Humidity displays "no".
8. Turn humidity knob clockwise to "yes" with cavity door open, to initiate the calibration process.

NOTE: Timer display will toggle between "OPEN" and "DOOR", and beeps if door is closed. Timer displays "dry", humidity displays "no", after confirming cavity is dry.

9. Turn humidity knob to "yes" to confirm cavity is dry.
 - Convection fan will turn on.
 - Timer display flashes "---" when conditions are ready for calibration.

NOTE: Oven cavity temperature must be below 100°F. If temperature not less than 100°F / 38°C, timer display toggles cool/xxx°F (xxx°F / xxx°C = current temperature), until temperature is below 100°F / 38°C.

NOTE: If conditions are not met: ("P33" less than or equal to 24, cavity temperature less than 100°F / 38°C, with door open, and convection fan up to speed), the system will not allow user to enter 0000 in the timer and will beep.

NOTE: To exit out of calibrating oxygen sensor board before calibrating, turn Humidity knob to "no" or turn Temperature knob to exit.

10. Turn timer knob clockwise to "0000", one digit at a time to calibrate the sensor.
 - Timer displays "donE" and Humidity displays "yes" when complete.
 - Convection fan turns off.
 - Humidity display should read between .00 and .99.
11. Check oxygen sensor board.
 - A. Turn temperature knob clockwise to "P33".
 - Timer display should read between 0 and 2.
 - B. Turn temperature knob counterclockwise until "---" displayed to exit out of configuration mode 1972.

NOTE: This value should be near 0%. For example, timer = 2, humidity = .99, represents 2.99%.

CHECK OXYGEN SENSOR DATE CODE (REPLACEMENT SENSORS)

- Use only replacement sensors with date code August 2016 and higher.
- Date code is indicated on sensor by first 3 numbers in the location shown by the red box as shown in [Fig. 117](#).
- Replacement sensors require revision 12 oxygen sensor board firmware.
- Refer to Service Mode 1963 to check oxygen sensor board firmware revision (See Test O2).

BOSCH Date Codes

Year	JAN	FEB	MAR	APR	MAY	JUN	JUL	AUG	SEP	OCT	NOV	DEC
2013	301	302	303	304	305	306	307	308	309	310	311	312
2014	417	418	419	420	453	454	455	456	457	458	459	460
2015	517	518	519	520	553	554	555	556	557	558	559	560
2016	617	618	619	620	653	654	655	656	657	658	659	660
2017	717	718	719	720	753	754	755	756	757	758	759	760
2018	817	818	819	820	853	854	855	856	857	858	859	860
2019	917	918	919	920	953	954	955	956	957	958	959	960
2020	037	038	039	040	073	074	075	076	077	078	079	080



Fig. 117

31355

TEMPERATURE SENSOR (RTD1) TEST



⚠ WARNING

Certain procedures in this section require electrical test or measurements while power is applied to the machine. Exercise extreme caution at all times and follow Arc Flash procedures. If test points are not easily accessible, disconnect power and follow Lockout/Tagout procedures, attach test equipment and reapply power to test.

1. Remove RIGHT PANEL.
2. Remove probe lead wires from Main I/O board.
3. Test probe with an ohmmeter.
4. If out of range, remove REAR PANEL, then remove wires from terminal block TB2 and test again.

TEMPERATURE in °F	RESISTANCE ±5 OHMS
60	530
70	541
80	552
90	563
100	573
125	600
150	627
200	680
250	732
300	785
350	836
400	887
450	938

TEMPERATURE CALIBRATION

1. Place temperature tester probe in geometric center of oven cavity.
 2. Program a setpoint of 350°F. Allow oven temperature to cycle 3 times.
- NOTE:** Oven's temperature display shows setpoint. To view actual cavity temperature as it cycles around

setpoint, slightly turn temperature knob clockwise one notch or counterclockwise one notch and actual cavity temperature will blink three times.

NOTE: Turning temperature knob more than one notch will change temperature setpoint.

3. Record **temperature tester** readout for an additional 3 cycles. It should cycle around setpoint.

Temperature Data Recording Table		
Temperature Tester Heater Turn On	Actual Average (Turn On + Turn Off) divide by 2	Temperature Tester Heater Turn off
_____	_____	_____
_____	_____	_____
_____	_____	_____

4. Calculate amplitude. Amplitude = (Turn Off - Turn On). An amplitude of more than 40°F may indicate a problem with heat source. For example, poor combustion, see combustion analysis.
5. Calculate average. Actual average = (Turn On + Turn Off) divided by 2. Variance (between actual average and programmed setpoint) of greater than 5 degrees indicates that adjustment is needed.
6. To adjust:
 - A. Enter CONFIGURATION MODE (1972) - GAS, scroll temperature knob to P24. Turn humidity knob to enter offset.

NOTE: Turn humidity knob *clockwise* for positive offset, to *lower* overall cavity temperature.

NOTE: Turn humidity knob *counterclockwise* for negative offset, to *raise* overall cavity temperature.

- B. If actual average temperature is higher than programmed setpoint, enter a positive offset value of same amount. (For example, if oven is cycling around an actual average of 360°F, adjust by entering an offset of +10°F.)
- C. If the actual average temperature is lower than programmed setpoint, enter a negative offset value of the same amount. (For example, if oven is cycling around an actual average of 340°F, adjust by entering an offset of -10°F.)

- 1) The offset can be adjusted ± 30 degrees, but is only functional within the operating limits of the oven. Factory setting is 0.
7. To save setting, exit configuration mode by turning temperature knob back to "----" (idle mode) and listen for beep.
8. To recall offset value, enter CONFIGURATION MODE (1972) - GAS, turn temperature knob to P24. Verify the value set is visible in humidity.

EXTERNAL MEAT PROBE THERMOCOUPLE CALIBRATION

NOTE: ABCx-xxxP devices only.

1. Place end of probe into slurry of ice and water.
2. Insert probe into socket on front panel of oven.
3. Log into CONFIGURATION MODE (1972) - GAS.
4. Check probe temperature by turning temperature knob clockwise to P21.
 - Timer display should read PCAL.
 - Humidity display should read 0, (default zero offset).
5. Calibrate probe (P21).
 - A. Turn timer knob clockwise to view current calculated probe temperature.

NOTE: Calculated probe temperature is TC2 input with P21 applied.

- B. Turn humidity knob clockwise or counterclockwise to adjust offset (-10 through +10) until timer display matches the input.

NOTE: Timer display reads 32 with ice water input.

- C. Exit out of configuration mode 1972.

CAVITY VENT SWITCH TEST AND ADJUSTMENT

Y10 TEST

Y10 test measures motor current, conditions of two vent switches and time it takes for the two switches, to indicate a change for the vent. Each time the test runs, the motor should turn $\frac{1}{4}$ of a turn. A $\frac{1}{4}$ turn is what it takes to make the vent to go from fully closed to fully open, or from fully open to fully closed. It is recommended this test be run eight times so the motor will go through 2 full cycles. If no errors are

encountered, vent switches and vent motor are operating properly.

1. Go into SERVICE MODE (1963).
2. Turn temperature knob until Y10 comes on display.
3. Turn humidity knob one step clockwise.

NOTE: Test will take about 15 seconds.

NOTE: Timer display will go from (VEnt / CLSd, to SPin / = 5, to VEnt / oPEn) or (VEnt / oPEn, to SPin / = 5, to VEnt / CLSd).

4. If test ran successfully, turn humidity knob one detent clockwise to run test again. Complete test eight times.

If an error occurs:

- Timer display showing "Err" means vent switches are in an error state and need adjusted or replaced.
- Timer display showing "=Err" means vent motor did not draw current.
- After 75 seconds, if vent switches do not indicate a $\frac{1}{4}$ turn has been made, the humidity display will show "Err".

CAVITY SHAFT SET SCREW ADJUSTMENT



⚠ WARNING

Disconnect the electrical power to the machine and follow lockout / tagout procedures.

1. Turn damper camshaft by hand.
 - If damper camshaft is loose, continue to next step.
 - If unable to turn by hand, refer to VENT SWITCH ADJUSTMENT; cavity shaft does not need adjusted.
2. Remove CAVITY VENT MOTOR.

NOTICE

Removing motor allows you to locate the flat on the shaft to tighten set screw on.

3. Spin shaft to locate flat.
4. Install motor.
5. Rotate shaft to locate set screw over the flat on shaft.
6. Tighten set screw.
7. Perform Y10 test in Service Mode.

VENT SWITCH ADJUSTMENT



WARNING

Disconnect the electrical power to the machine and follow lockout / tagout procedures.

1. Loosen screws securing vent to the frame (by 1/4 turn) to allow top of switches to be adjusted in or out.



Fig. 118

2. Remove wires 44, 45, 46, and 47 from vent switches

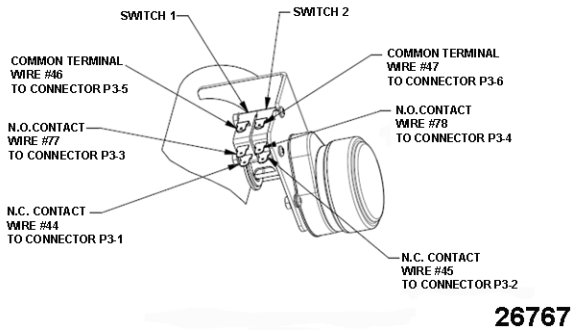

Fig. 119

3. Rotate damper camshaft (using a pair of channel locks) until indicator on the end of the camshaft is at diagonal (Fig. 120).

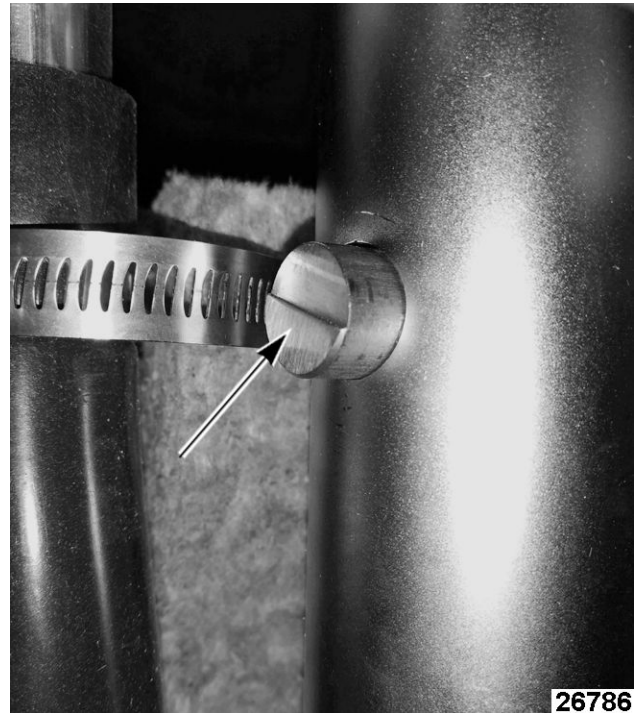

Fig. 120

4. Connect a meter set to check resistance to the common terminal and N.C. contact of switch 1.

NOTE: If meter reading indicates an open, pull top of switch away from camshaft. If meter reading indicates continuity, continue to next step.

5. Press top side of switches towards camshaft until meter indicates an open.
6. Tighten screws securing switches.
7. Use meter to check the common terminal and N.C. contact of both switches. Both switches at this point should read open.
8. Perform a quick check.
 - A. Connect a meter set to check resistance to the common terminal and N.C. contact of switch 1.
 - B. Rotate damper camshaft through one revolution using channel locks.
 - C. During one revolution of the Cam shaft, the meter should indicate continuity at two different spots. These two spots should be 180° from each other.
 - D. Repeat this check for switch 2.
9. Reconnect wires to both vent switches.
10. Reattach panels.

DOOR TO CONTROL PANEL ALIGNMENT

Alignment Checks

1. Visually check to see if control panel (1, Fig. 122) is flush with the frame (2, Fig. 122) of the oven along the top (Fig. 121) and side. **Not** with the top trim (3, Fig. 122).

Front/Top View



Fig. 121

Side View

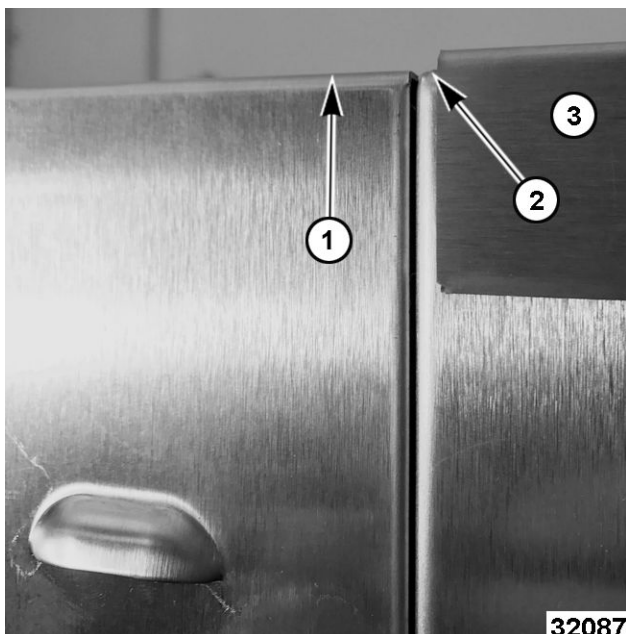

Fig. 122

2. Verify door alignment to control panel with straight edge.



Fig. 123

3. Verify door spacing is correct.
 - A. Insert the Go gauge (.119") above and below plunger within the black handle bezel area.

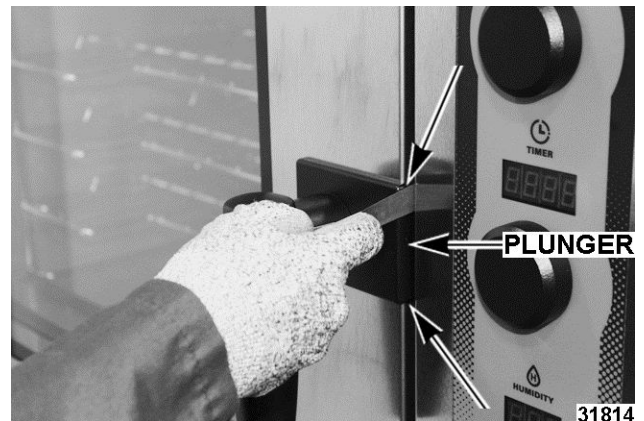

Fig. 124

- B. Insert No-Go gauge (.200") above and below plunger within the black handle bezel area.
4. If oven failed any alignment checks, do the following adjustments.
 - Visual alignment check of the control panel failed, perform Control Panel Adjustment.
 - Visual alignment check of the door failed, perform Door Adjustment.
 - Go/No-Go gauge check failed, perform Door Adjustment.

NOTICE

All three alignment checks must pass before checking door operation.

5. Verify door operates correctly.
 - A. Check that the door comes to about an inch from closing before it compresses gasket.
 - B. Verify door closes without slamming.
 - C. Handle should turn smoothly with little effort to unlatch.

Control Panel Adjustment



WARNING

Disconnect the electrical power to the machine and follow lockout / tagout procedures.

1. Remove right panel.
 - A. Remove four right panel screws.
 - B. Lift right panel up and back using handles.

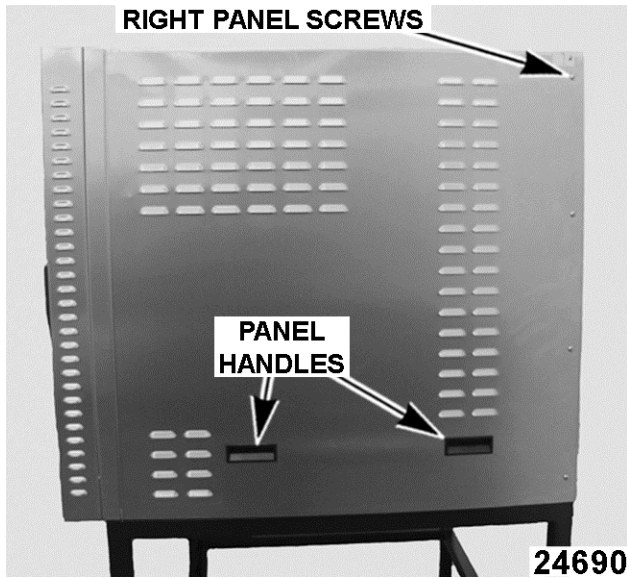

Fig. 125

2. Slightly loosen six screws securing control panel.



Fig. 126

NOTE: Only loosen screw enough that the alignment of the control panel can be adjusted with some effort.

3. Adjust the control panel (1, Fig. 128) until it is flush with the frame (2, Fig. 128) of the oven along the top (Fig. 127) and side. Not with the top trim (3, Fig. 128).

Front/Top View



Fig. 127

Side View

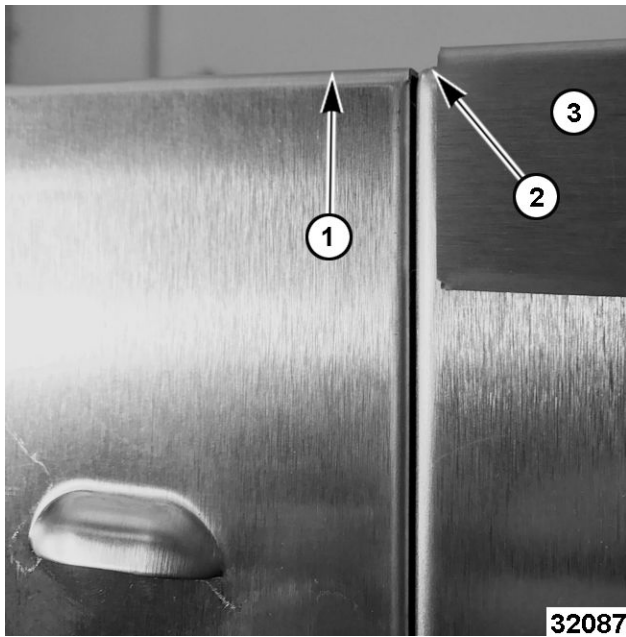

Fig. 128

4. Tighten screws securing control panel at 24 in. lbs.
5. Repeat all three Alignment Checks.

Door Adjustment

1. Loosen top and bottom hinge screws slightly to allow door to move.



Fig. 129

2. Adjust door (1, Fig. 130) so top is flush with control panel (2, Fig. 130).

NOTE: Keep in mind you must keep the proper distance between the door and control panel (3, Fig. 130) for Go/No-Go gauge to pass.



Fig. 130

3. Tighten door hinge screws at 75 in. lbs.
4. Repeat all three Alignment Checks.

DOOR SWITCH ADJUSTMENT

1. In SERVICE MODE (1963), run (Y6) Door test.

NOTE: If the door test reports that the door is open when it is closed it may be because the door reed switch is not lined up with the magnet in the door.

To adjust the door reed switch:



⚠ WARNING

Disconnect the electrical power to the machine and follow lockout / tagout procedures.

- A. Remove RIGHT PANEL.
- B. Remove CONTROL PANEL.

- C. Loosen screws and nuts to adjust and obtain dimensions as shown in Fig. 131.

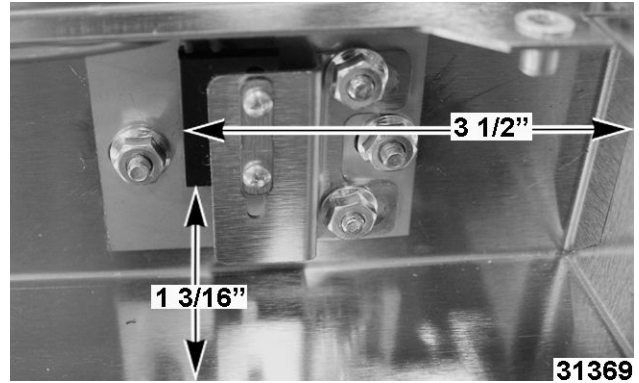

Fig. 131

- D. Verify wire location as shown in Fig. 132.

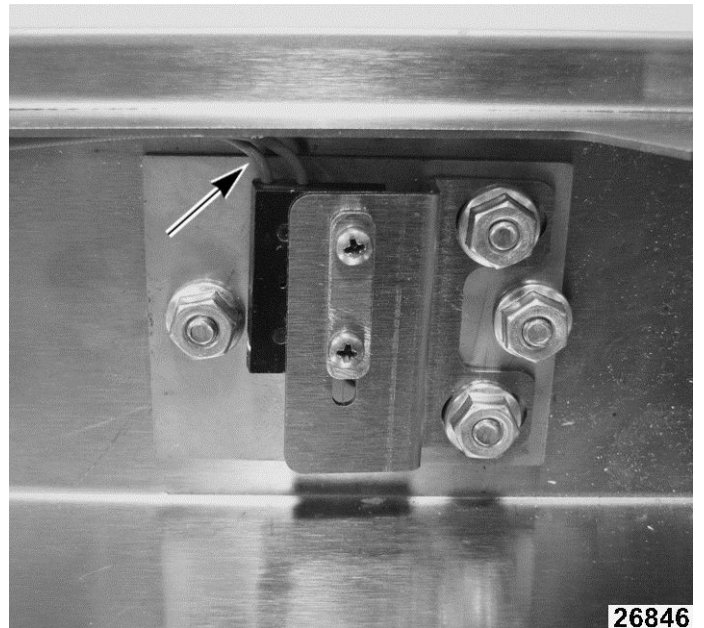

Fig. 132

TRANSFORMER RESISTANCE CHECK



WARNING

Certain procedures in this section require electrical test or measurements while power is applied to the machine. Exercise extreme caution at all times and follow Arc Flash procedures. If test points are not easily accessible, disconnect power and follow Lockout/Tagout procedures, attach test equipment and reapply power to test.

1. Unplug both primary and secondary side of transformer.
2. Measure resistance at both plug connections.
3. Verify resistance is $\pm 10\%$ for each reading. Refer to [Fig. 134](#).

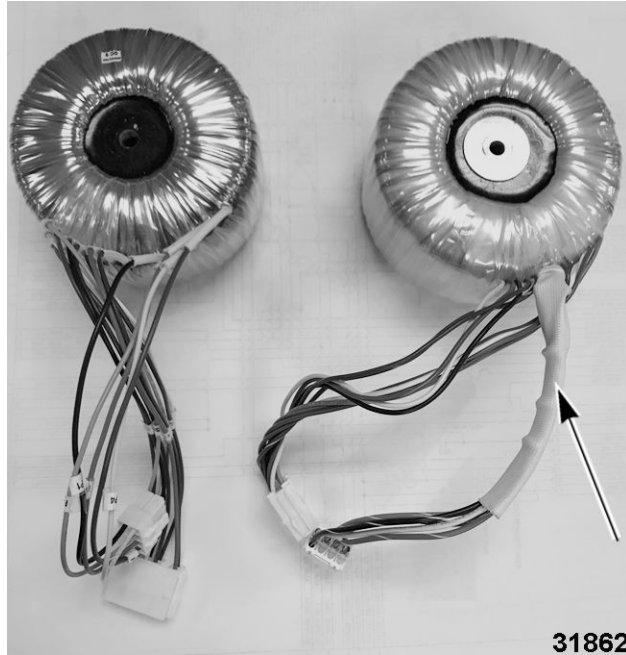

Fig. 133

NOTICE

There are two types of transformers, one with a wire harness sleeve and one without. Use the proper diagram for the transformer you are servicing in [Fig. 134](#).

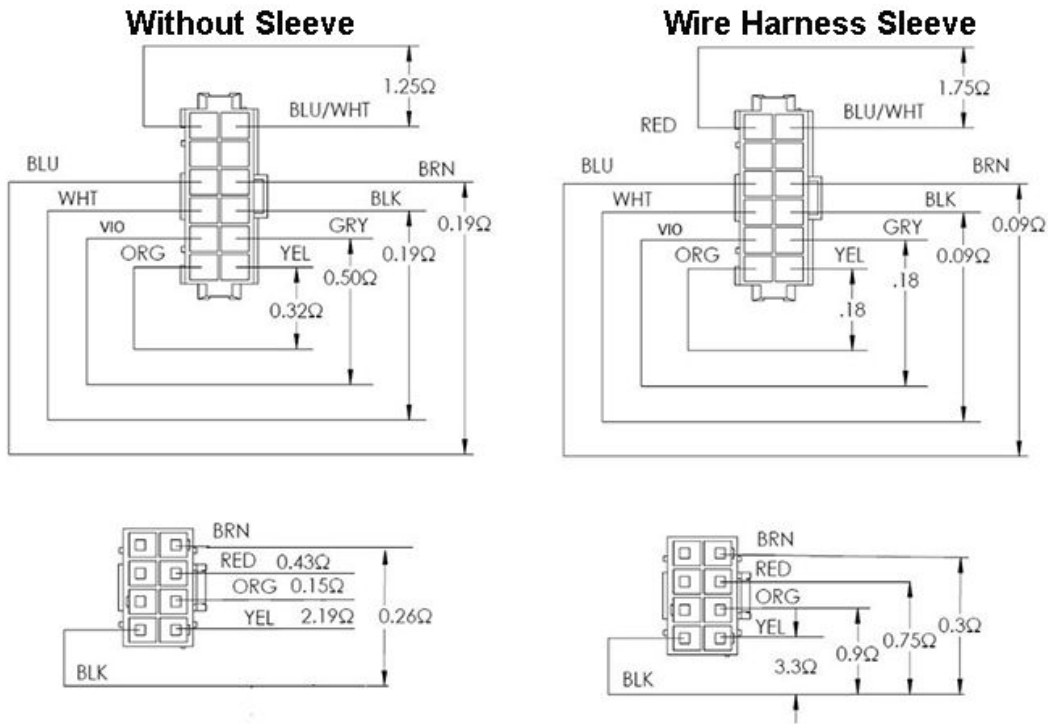

Fig. 134

31864

MOTOR RESISTANCE CHECK



⚠ WARNING

Certain procedures in this section require electrical test or measurements while power is applied to the machine. Exercise extreme caution at all times and follow Arc Flash procedures. If test points are not easily accessible, disconnect power and follow Lockout/Tagout procedures, attach test equipment and reapply power to test.

1. Remove REAR PANEL.
2. Note and disconnect motor wires (1, Fig. 135) at TB2.

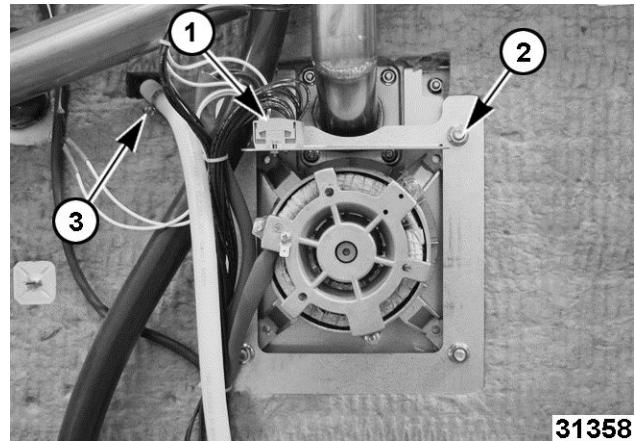

Fig. 135

31358

3. Measure resistance.

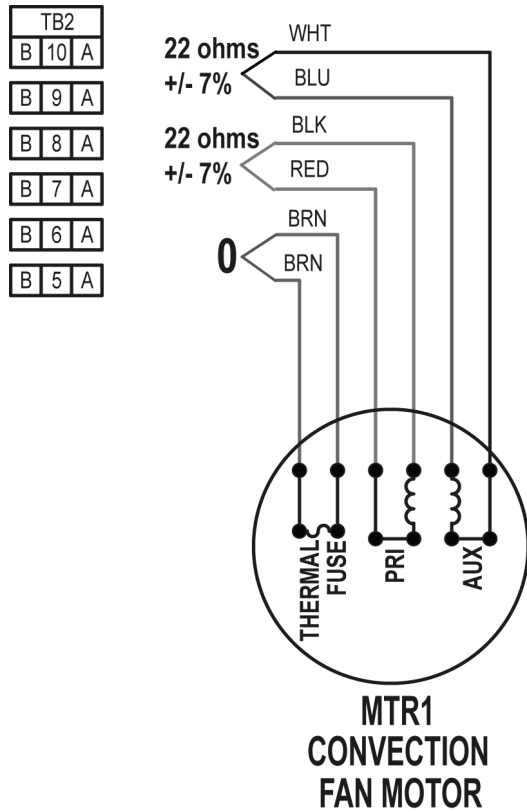

Fig. 136

4. Reconnect motor wires to TB2.
5. Install REAR PANEL.
6. Verify proper operation.

GAS VALVE PRESSURE CHECK AND ADJUSTMENT



⚠ WARNING

Disconnect the electrical power to the machine and follow lockout / tagout procedures. There may be multiple circuits. Be sure all circuits are disconnected.



⚠ WARNING

Shut off the gas before servicing the unit and follow lockout / tagout procedures.

1. Remove RIGHT PANEL.

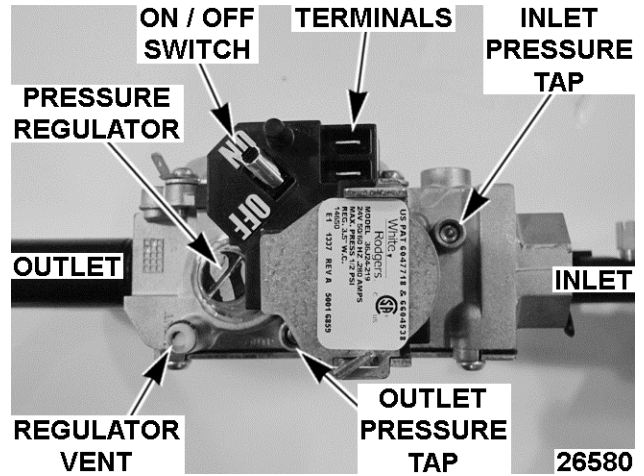

Fig. 137

2. Test inlet manifold pressure.
 - A. Open inlet pressure tap by turning screw 1 to 2 turns counterclockwise.
 - B. Attach manometer hose to inlet pressure tap.

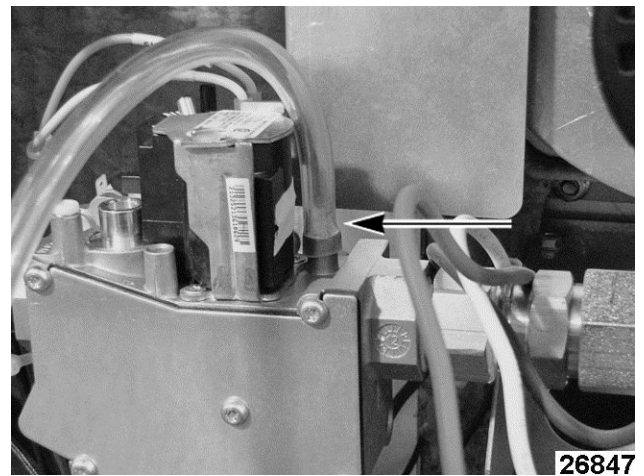

Fig. 138

- C. Reconnect power and turn gas supply on.
 - D. If static line pressure exceeds 14" W.C. (½ psig) the customer must supply and install a pressure reducing valve to reduce the pressure below the maximum allowable for the valve.
 - E. Close inlet pressure tap by turning screw CW. until tight.
3. Test outlet and adjust manifold pressure.
 - A. Open outlet pressure tap by turning screw 1 to 2 turns CCW.
 - B. Remove the pressure regulator adjustment cap from the main gas valve to access the adjustment screw.

- C. Attach manometer hose to outlet pressure tap.

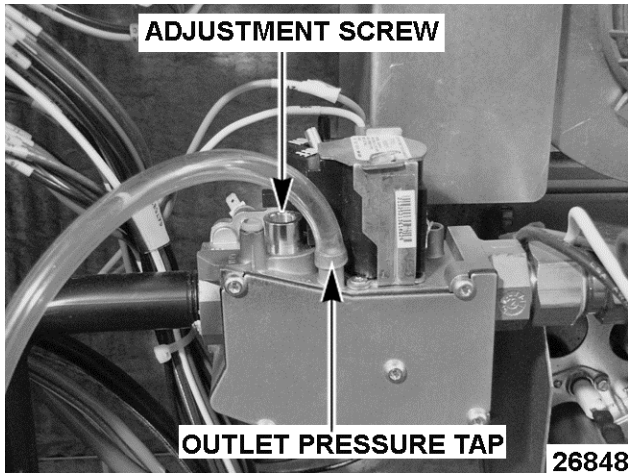

Fig. 139

- D. Reconnect power and turn gas supply on.
- E. Set Temperature knob to call for heat.

NOTE: Accurate gas pressure adjustment can only be made with the burner on.

NOTE: Turn adjustment screw *clockwise* to increase the pressure. Turn adjustment screw *counterclockwise* to decrease pressure.

- F. Set Manifold pressure to 3.5" W.C.

NOTE: Always replace the adjustment cap after adjustment and securely tighten to ensure proper operation.

- G. Close outlet pressure tap by turning screw CW until tight.

Orifice Sizes		
Altitudes	Natural Gas	L.P. Gas
0 - 1999 ft.	# 40	#53
2000 - 2999 ft.	# 41	# 54
3000 - 5999 ft.	# 42	# 54
6000 - 7999 ft.	#43	# 54
8000 - 9999 ft.	# 44	# 55
Above 10,000 ft.	# 45	# 55

	Natural Gas		L.P. Gas	
	Min.	Max.	Min.	Max.
Static Line Pressure	5"	14"	11"	14"
Manifold Pressure	3.5" W.C.		10" W.C.	
BTU / Hr	80,000		80,000	

- 4. Install right panel.

- 5. Verify operation.

FLAME SENSE VOLTAGE TEST (FENWAL SERIES 35-61)



⚠ WARNING

Certain procedures in this section require electrical test or measurements while power is applied to the machine. Exercise extreme caution at all times and follow Arc Flash procedures. If test points are not easily accessible, disconnect power and follow Lockout/Tagout procedures, attach test equipment and reapply power to test.

NOTE: The minimum flame voltage necessary to keep the system from lockout is **.7 Volts**.

- 1. Connect a DC voltmeter to FC-FC+ terminals.

FLAME SENSOR VOLTAGE CHECK FENWAL SERIES 35-61

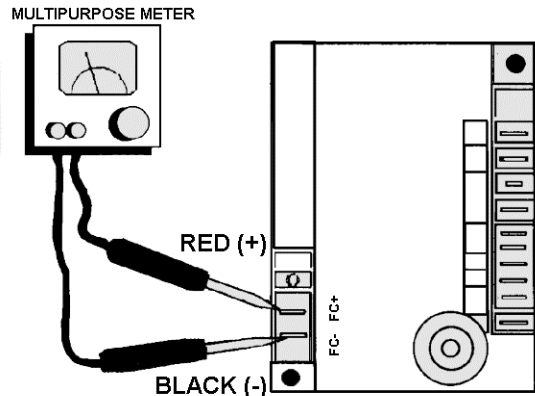

24939

Fig. 140

- 2. Meter should read .7 volts or higher.

NOTE: If reading is below "0" volts, reverse meter leads and take another reading.

- 3. Disconnect power and reconnect leads for proper polarity.
- 4. Check for proper operation.

DRAFT INDUCER TEST



WARNING

Disconnect the electrical power to the machine and follow lockout / tagout procedures.

1. Using two 1/4" hoses and a T-connector, connect an incline manometer inline between the inducer fan and pressure switch.

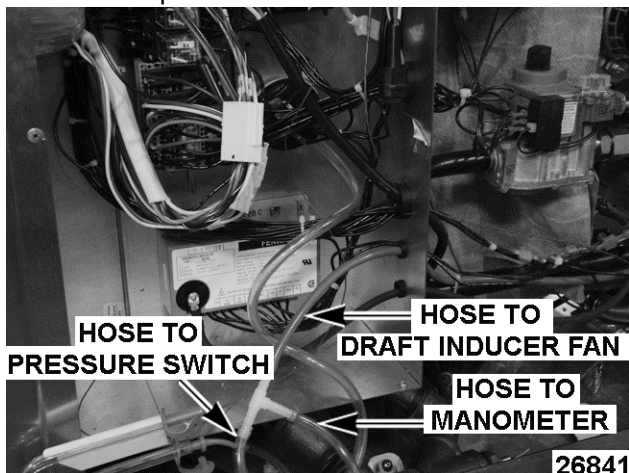

Fig. 141

2. Log Into SERVICE MODE (1963).
 - A. Turn unit on.
 - B. Turn timer knob counterclockwise until timer display shows "SEt".
 - C. Turn humidity knob counterclockwise until humidity display shows "PAS".
 - 1) Timer display will show "2000".
 - D. Turn timer display counterclockwise to 1963.
 - 1) Timer display will flash "1963".
 - 2) Timer and humidity display will flash twice.
 - 3) Humidity display changes from "PAs" to "tst" when logging into service mode.
 - E. Use the temperature knob to advance to Y16 (Blower /Air Pressure Switch test).
 - F. Use humidity knob to start draft inducer fan.
 - Oven should pass the test.

NOTE: Pressure switch requires a minimum of 1" W.C. negative pressure to operate.

- Reading on manometer should be approx. 3" WC of negative pressure.
3. Exit service mode.
 - A. Turn temperature knob counter clockwise until "---" is displayed.
 4. Use temperature knob to make setpoint 300°F.
 - A. With burner ignited, reading on manometer should settle approx. 1.6" WC of negative pressure.
 5. Turn temperature knob counterclockwise until "---" is displayed.
 6. Log into SERVICE MODE (1963).
 - A. Turn timer knob counterclockwise until timer display shows "SEt".
 - B. Turn humidity knob counterclockwise until Humidity display shows "PAS".
 - 1) Timer display will show "2000".
 - C. Turn timer display counterclockwise to 1963.
 - 1) Timer display will flash "1963".
 - 2) Timer and humidity display will flash twice.
 - 3) Humidity display changes from "PAs" to "tst" when logging into service mode.
 - D. Use temperature knob to advance to Y16 (Blower / Air Pressure Switch test).
 - E. Use humidity knob to start draft inducer fan.
 - Oven should pass the test.
 - With heat exchanger being at 300°F, reading on manometer should be approx. 2" WC of negative pressure.
 7. Exit service mode.
 - A. Turn temperature knob counterclockwise until "---" is displayed.

COMBUSTION ANALYSIS

1. Verify manifold pressure. Refer to GAS VALVE PRESSURE CHECK AND ADJUSTMENT.
2. Insert combustion analyzer meter 8" into air sampling tube at approximately (300°F +/- 50°F) (149°C +/- 25°C) for combustion tests.

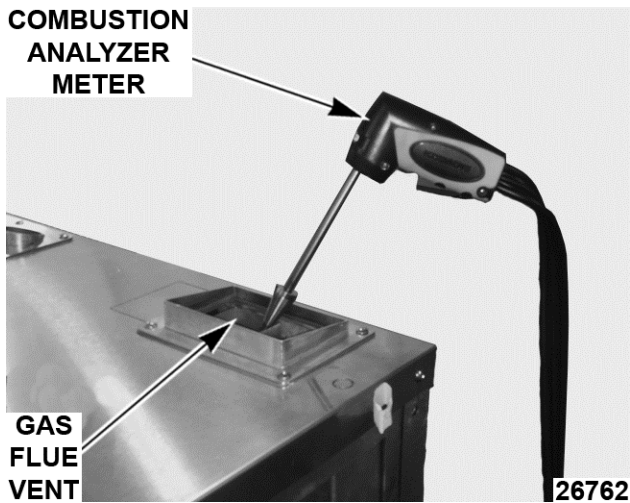

Fig. 142

3. Set oven temperature to 450°F (230°C) with a burner flame established, take combustion measurements O₂ and CO readings.

NOTICE

If correct combustion reading cannot be obtained, verify orifice size is correct for gas type. Refer to ABC Combi Oven Gas / Elevation Conversion Kit for proper orifice size.

- O₂: Range 4% to 10%
- CO: Not to exceed 0.04% (400 PPM)

NOTE: If correct combustion readings cannot be obtained, contact Cooking Support.

ELECTRICAL OPERATION

COMPONENT FUNCTION

Main Board	Manages all input/output functions of oven as required for combi cook operation. Monitors oven temp RTD probe, and outputs call for heat to ignition module. Monitors oxygen sensor board and outputs to humidity valves. Monitors condensate tempering thermocouple probe and outputs to condensate valve, monitors door switch and controls cavity lights. Outputs to motor control board to control speed and direction of Convection Fan motor. Rotates the cavity vent intake damper from open/closed using the cavity vent motor output and two cavity vent switch inputs. Monitors on/off switch to change operator interface from sleep/wake mode. Enables cooling fans. Monitors the display board for customer input from knobs, and sends time, temperature, and humidity information to display board. Also monitors ignition module NC output, pressure switch NC contact for ignition errors. Monitors N.O. relay contacts for high limit errors and monitors oxygen board and motor board for oxygen sensor and convection fan motor errors.
Display Board	Processes signals from each encoder mounted to each of the three control knobs. Then sends signal to Main board. Processes input signals from Main board to refresh displays with Time Temperature and Humidity cooking information.
Motor Control Board	Low voltage portion of the board processes drive signal (amber LED) and reverse signal (green LED) from the Main board to control an on board reversing relay and external solid state relay. The reversing relay contacts on the high voltage side of the board reverses voltage phases to change the motor rotation direction; the solid state relay wired to the motor board, and power the convection fan motor. The motor neutral phase is daisy chained with convection fan motor's thermal fuse and F7 motor current protection fuse at the motor board. The motor board's current sense circuit monitors the current through the fuses and sends a low voltage signal back to the main board (viewed on the RED LED) on the low voltage side. The current sense circuit is also responsible for detecting E1 and E6 errors.
Oxygen Sensor Board	Heats and controls the oxygen sensor, and reports back oven cavity humidity information to the Main board. Also receives calibration command from Main board.
Oxygen Sensor (SW5)	Measures the amount of humidity in the oven cooking cavity, and is controlled by oxygen sensor board.
Door Switch (SW3) ...	Magnetic reed switch. It senses the presence of the magnet in the door and closes. Monitored by the main board, which starts stops the cook cycle and activates the lights based on the state of the door switch.
ON / OFF Switch (SW4)	Is a toggle switch that is monitored by main board to put unit from sleep to cooking idle mode. It provides 230 VAC to the following relays on the main board: cavity vent motor, high and low humidity valve, condensate tempering valve, cooling fans.
Encoders (SW7, SW8, SW9)	Optically coupled rotary encoder switch that is mounted behind the control knob and sends signal to display board as knob is turned in any direction or pushed.
Transformer (T1)	Transformer, with 120 VAC input. Multiple secondary voltages are as follows: 230 VAC to motor board and convection fan motor, vent motor, all water solenoids and cooling fans, 12 VAC oxygen board and oxygen sensor, 12 VAC cavity lamps, 24 VAC main board, motor board (low voltage portion), vent switches, door switches, high limit sensing contacts, 24 VAC to ignition module and gas valves.
Terminal Block (TB1)	Incoming voltage supply connection. Transformer to 230 VAC connections.
Terminal Block (TB2)	Convection Fan Motor (MTR1) and Oven sensor (RTD1) connection.

Terminal Block (TB4)	Low voltage outputs from transformer connection.
Fuse (F1)	4A - Protects Oxygen Sensor Board.
Fuse (F2)	4A - Protects Cavity Light circuit.
Fuse (F3)	4A - Protects main board, motor board (low voltage portion), vent switches, door switches, high limit sensing contacts
Fuse (F4)	4A - Protects Ignition Module circuit and Relay R4.
Fuse (F7)	6.25A - motor current protection fuse. F7 protects from a malfunction of the motor board's on-board reversing relay.
Fuse (F8)	5 A - Protects Oxygen Sensor Board. (Mounted on Oxygen Sensor Board.)
Oven Door Lights (L1, L2, L3)	Provides light for the oven cavity (located in door frame). Voltage to light circuit. (12 Volt, 5 Watt Bulbs).
Cavity Vent Motor (Mtr2)	Controls the oven cavity vent intake damper inside the Cavity Vent Intake Tube.
Cavity Vent Open(SW1)	Reports the position (open/closed/spin) of the cavity vent intake damper. Works in conjunction with SW2.
Cavity Vent Closed (SW2)	Reports the position (open/closed/spin) of the cavity vent intake damper. Works in conjunction with SW1.
Humidity Valve Cavity (Low Flow) (Sol2)	Admits water into the injection nozzle (in a slow stream) that drips onto water atomizer to vaporize the water droplets and provide steam for combi mode or cool the oven temperature.
Humidity Valve Cavity (High Flow) (Sol3)	Admits water into the injection nozzle (in a slow stream) that drips onto water atomizer to vaporize the water droplets and provide steam for combi mode or cool the oven temperature.
Cooling Fans (CF1, CF2, CF3)	Circulate air through the oven control panel, display panel, and convection fan motor area for component cooling.
Convection Fan Motor (Mtr1)	Circulates air through the oven cavity. Is driven by Motor Control Board through capacitor C1. Reverses direction at programmed intervals.
Oven Sensor Input (RTD1)	Senses oven cavity temperature and is monitored by the Main board.
Air Pressure Switch (SW6)	Monitors VACuum created by the draft inducer motor. Prevents burner ignition if a vacuum of 1" W.C. is not present.
High Limit (TS1)	Removes power from ignition module if oven overheats. The state of the high limit is sensed by relay R5 which signals Vulcan Main I/O board to display error code.
Spark Electrode	Ignites the gas.
Flame Sense Probe ...	Senses the presence of a flame.
Cavity Gas Valve (V1)	Controls the gas flow.
Ignition Module	Controls the inducer blower and gas valve. Generates the spark for burner ignition, monitors the pressure switch and the presence of a flame and controls the No ignition light.
Inducer Blower Motor (MTR3)	When energized, drives fan to generate draft required for proper oven operation, and exhausts combustion products out of flue.
Cold Water Condensate (Sol1)	Admits water to p-trap on power up to seal oven cavity. And admits water ptrap to mix with drain water to cool drain discharge water to 140°F before exiting oven.

Drain Water Sensor Input (TC1)	Monitors drain water temperature and is monitored by the Main board.
External Meat Probe Thermocouple Input (TC2)	Monitors food product temperature, and is monitored by the main board when external probe is plugged into socket on front panel then inserted into food product (units with probe).
Motor Interlock Relay (R1)	Removes power to the motor control board when On/Off switch is Off.
Heat Interlock Relay (R2)	Is used to disable the call for heat signal from the main board to the ignition module when the On/Off switch is Off.
Oxygen Board Interlock Relay (R3)	Removes power to the oxygen board and sensor when the On/Off switch is Off.
Inducer Blower Relay (R4)	Used to disable the ignition module and to supply power to the combustion blower in the test mode.
High Limit Sense Relay (R5)	Is used to report the condition of the High Limit Switch to Main Board.
Fan Motor Relay (R6)	Solid State Relay used to drive the convection fan motor. Is controlled by the motor control board.
Ferrite	Passive electric component used to suppress high frequency noise from the oxygen sensor board.
.....	

ELECTRICAL PANEL COMPONENT LOCATION

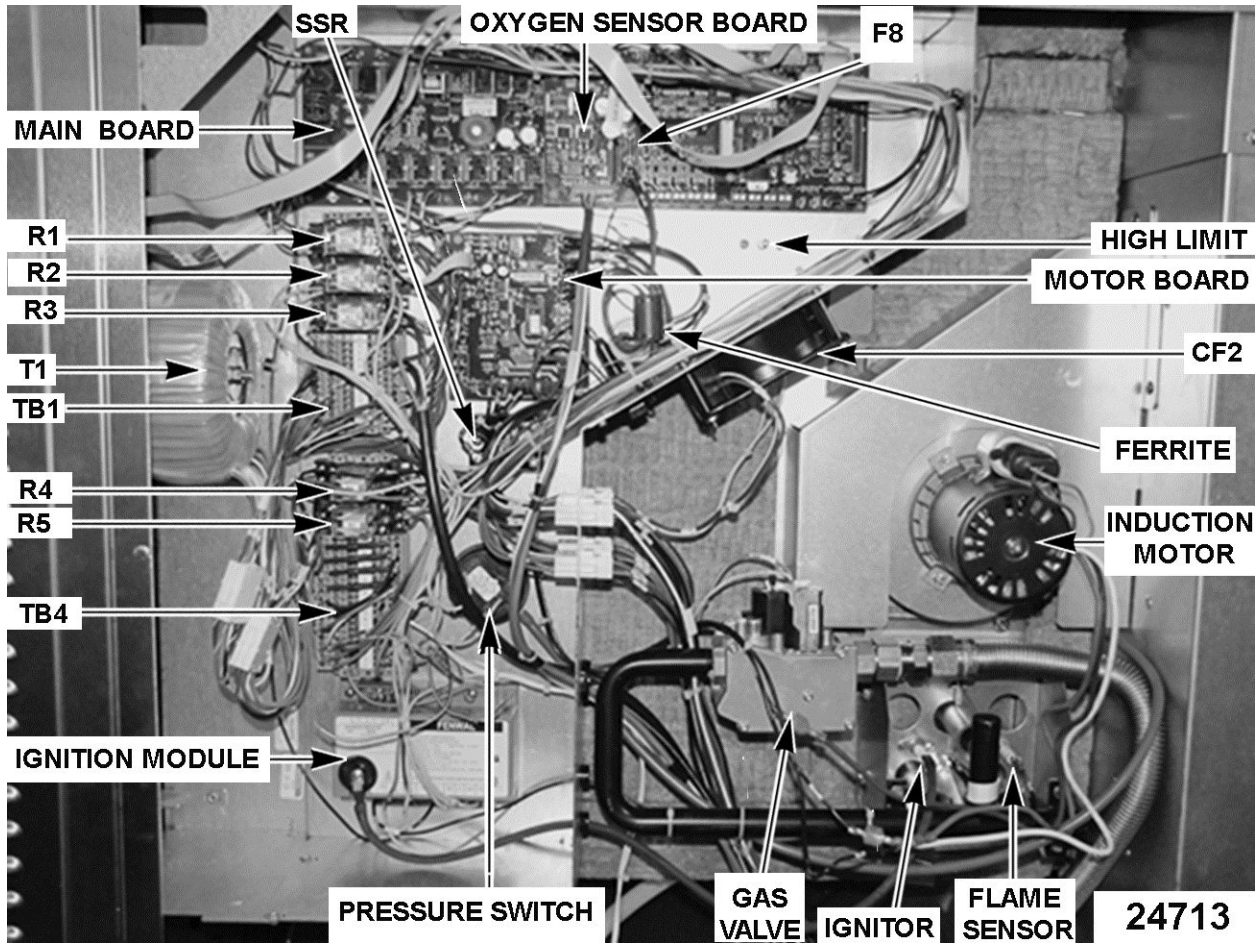

Fig. 143

SEQUENCE OF OPERATION

NOTE: Refer to schematic diagram for the electrical sequence of operation.

Conditions	
1. Unit plugged into 120 VAC incoming power supply and is properly grounded.	
2. ON/OFF switch (SW4) off.	
3. Door switch closed (SW3).	
4. High limit switch (TS1) closed.	
5. 120 VAC	<ul style="list-style-type: none"> A. 120 VAC to TB1-9C to: <ul style="list-style-type: none"> 1) Blower test relay's COM contact (R4.2). 2) L1 (blower relay) on ignition module. B. 120 VAC (Com) to TB1-8A to: <ul style="list-style-type: none"> 1) Inducer blower COM. C. 120 VAC to Transformer T1 (TB1-9, TB1-8) for correct oven voltage on primary input of T1. <ul style="list-style-type: none"> 1) Transformer step up from 120 VAC to 230 VAC providing voltage for oven components (solenoid valves, motor board (convection fan motor), vent intake motor, and cooling fans. 2) Transformer steps down from 120 VAC to 24 VAC on two secondaries, 24 VAC and 24 VAC (IM). <ul style="list-style-type: none"> a. 24 VAC (IM) providing voltage for relay coils R4, R5, for high limit switch, and for ignition module and gas valve, call for heat relays. b. 24 VAC providing voltage for main board, motor board, vent switches, door switch. 3) Transformer steps down 120 VAC to 12 VAC on two secondaries, 12 VAC (Lite) and 12 VAC (Oxy). <ul style="list-style-type: none"> a. 12 VAC (Lite) Light providing voltage for the cavity door lights. b. 12 VAC (Oxy) providing voltage for oxygen sensor board and oxygen sensor.
6. 230 VAC	<ul style="list-style-type: none"> A. 230 VAC from transformer through TB1-6 to: <ul style="list-style-type: none"> 1) On/Off Switch (SW4). 2) Motor Interlock Relay (R1.2) Common contact. B. 230 VAC (Com) from transformer through TB1-3, TB1-4 and TB1-5 to: <ul style="list-style-type: none"> 1) Cavity Vent (M2). 2) V2 Main Board. 3) Oxygen Interlock Relay coil (R3-B). 4) Heat Interlock Relay coil (R2-B). 5) Motor Interlock Relay coil (R1-B). 6) Motor Interlock Relay Common Contact (R1.1). 7) Cold Water Condensate Solenoid 1 (SOL1). 8) Humidity Valve Cavity (Low Flow) Solenoid 2 (SOL2). 9) Humidity Valve Cavity (Hi Flow) Solenoid 3 (SOL3). 10) Cooling Fans (CF1, CF2, and CF3).
	7. 24 VAC (IM)
	<ul style="list-style-type: none"> A. 24 VAC (IM) from transformer to TB4-14 through 4A fuse (F4) to: <ul style="list-style-type: none"> 1) High Limit Switch (TS1). 2) High Limit Sense Relay Coil (R5-A) through TS1. 3) V6 on Main I/O board. 4) V5 on Main I/O board. B. 24VAC (IM) (Com) from transformer to TB4-1, TB4-2, and TB4-3 to: <ul style="list-style-type: none"> 1) High Limit Sense Relay Coil COM (R5-B). 2) Gas Valve (V1) COM. 3) V1 (24V COM supply) Ignition Module. 4) V4 (call_ for_ heat common) Main I/O board. 5) V11 (fault detect common) Main I/O board.

- 6) Blower Test Relay Coil COM (R4-B).
- 8. 24 VAC
 - A. 24 VAC from transformer to TB4-16 through 4A fuse (F3) to:
 - 1) Cavity Vent Switch (SW1-COM).
 - 2) Cavity Vent Switch (SW2-COM).
 - 3) Hi Limit Sense Relay (R5.1-COM).
 - 4) Door Switch (SW3).
 - 5) V9 connection on Main I/O Board.
 - 6) P21 connection on Motor Control/ Reversing Board.
 - B. 24VAC (Com) from transformer to TB4-5 and TB4-6 to:
 - 1) P22 connection on Motor Control/ Reversing Board.
 - 2) V8 connection on Main I/O Board.
- 9. 12 VAC (oxy)
 - A. 12 VAC (oxy) from transformer to TB4 through 4A fuse F1 to:
 - 1) Oxygen board interlock relay COM contact (R3.1).
 - B. 12 VAC (oxy) COM from transformer to TB4 to:
 - 1) Oxygen board interlock relay COM contact (R3.2).
- 10. 12 VAC (lite)
 - A. 12 VAC (lite) from transformer to TB4 through 4A fuse (F2) to:
 - 1) V3 (Lamp) on Main board.
 - B. 12 VAC (lite) COM from transformer to TB4 to:
 - 1) Cavity Lamps (L1, L2, and L3) COM (Previous Production Models).
 - 2) Cavity Lamps (L1) COM (Current Production Models).
- 2. Heat Interlock relay coil (R2) energizes.
 - A. R2.1 closes, providing 24 VAC (IM) to Ignition Module, (through R4.1 normally closed contacts).
 - B. Ignition Module performs a self-check. Ignition Module light flashes once and enters a thermostat scan state.
 - C. R2.2 closes allowing the Call_For_Heat signal input from the Main board to pass to both Ignition module and XH2 pressure switch. (Which is not asserted at this point.)
- 3. R3 oxygen sensor board interlock relay coil (R3) energizes.
 - A. Providing 12 VAC (Oxy) to Oxygen Board across J1 (wire 42) and J2 (wire 43).
 - B. Rev. 11 FIRMWARE (as seen in SERVICE MODE (1963) o2 test).
 - 1) D3 (amber), D4 (red), D5 (green) LEDs energized for 2 seconds.
 - 2) D3 (amber) LED energized for 3 seconds confirming calibration of electronics on board.
 - 3) D4 (red) LED energized for 1-3 minutes while the oxygen board is heating up the oxygen sensor.
 - 4) D5 (green) LED blinks indicating transmission of Humidity data from Oxygen sensor board through piggyback connection to Main board.
 - C. Rev. 12 FIRMWARE (as seen in SERVICE MODE (1963) o2 test).
 - 1) D3 (amber), D4 (red), D5 (green) LEDs energized for 2 seconds.
 - 2) D5 (green) LED energized for 3 seconds confirming calibration of electronics on board.
 - 3) D3 (amber) LED (Rev. 12 firmware energized for 1-3 minutes while the oxygen board is heating up the oxygen sensor.

NOTE: Rev. 11 - Once in regulation, only the green LED blinks. However, due to sporadic electrical noise, the red LED may intermittently come on indicating undershoot or overshoot of the oxygen sensor's heater function (hysteresis). If this condition lasts longer than 60 seconds, condition is logged, E16.

**ON/OFF Switch (SW4) turned ON,
(No Call for Heat)**

- 1. Motor Interlock relay coil (R1) energizes.
 - A. Provides 230 VAC across P1 (wire 106) and P20 (wire 107) on Motor Board.
 - B. Convection fan motor (M1) energizes.

- 4) D5 (green) LED blinks indicating transmission of Humidity data from Oxygen sensor board through piggyback connection to Main board.

NOTE: Rev. 12 - Once in regulation, only the green LED blinks. However, due to sporadic electrical noise, the amber LED or the red LED may intermittently come on indicating undershoot or overshoot of the oxygen sensor's heater function (hysteresis). If this condition lasts longer than 60 seconds, the condition is logged, E22-28.

4. 230 VAC to V1 on Main board.
 - A. Main board sends Control signals through the ribbon cable to display board and illuminates the Temp (---) Time (--:--) and humidity (---) displays (---).
 - B. Y6 energizes the 3 cooling fans (CF1, CF2, and CF3).
 - C. Y9 energizes the cold water condensate Valve (Sol 1) to fill the Ptrap for 6 seconds so cold air does not get sucked up into the cooking cavity through the drain.
 - D. Y10 Cavity Vent Intake motor (Mtr2) energizes to close the vent (if previously open).
 - E. Main I/O board monitor SW1 and SW2 for the closed position, and de-energizes Y10, cavity vent intake motor.
 - F. Y13 energizes turning on the cavity lamp(s).

NOTE: Newer construction energizes one 10W lamp (L1). Older construction energizes three each of 5 Watt lamps (L1, L2, L3).

ON/OFF Switch (SW4) ON & with Call for Heat

1. Temperature knob turned, to enter Temperature setpoint. Sending signal from SW7 encoder to Main I/O board through the ribbon cable (for example 350°F).

NOTE: Timer (SW8 input) has no effect on the call for heat. no timed cooking.

Motor Control Board

1. Main I/O board sends controls signals through the ribbon cable to the motor board.
2. Amber colored LED turns on to indicate that a drive signal is being sent to the external solid state relay.

3. Green colored LED indicates the direction of the motor and toggles its state from on to off (or off to on) every 2 minutes during a cooking cycle.

NOTE: The state of the onboard reversing relay changes every two minutes (as indicated by the green led). This reverses the phases of the motor to reverse the direction of the motor.

4. Red LED indicates the presence of current in the convection fan motor, and signals the main I/O board through the ribbon cable.
5. The Solid State Relay (R6) energizes continually at default fan speed.

NOTE: Default convection motor fan speed is: F3, maximum.

6. Convection Fan Motor (Mtr1) energizes.

Ignition Module (blower test relay R4 off)

1. Y14 call_for_heat relay energizes.

NOTE: On the initial call for heat, a software counter begins to measure "call_for_heat" on time (see OVERSHOOT FEATURE).

2. Main I/O board reads back the call for heat (momentarily) on XH2 as part of the Error checking routine.
3. Main I/O board monitors the NC fault output from the ignition module as part of the Error checking routine.
4. 24 VAC (IM) is supplied to the TH/W thermostat input on the ignition module.
5. Ignition Module checks pressure switch at PSW input for normally open contacts.
6. Ignition Module energizes IND output and the Combustion blower (MTR3) energizes.
7. Ignition Module checks pressure switch at PSW input for closed contacts.

NOTE: Main momentary signal on Xh2 is now gone and the main board knows the pressure switch has been made.

8. Ignition Module combustion blower pre-purge delay begins, and combustion blower removes residual gas from combustion chamber.
9. Ignition Module energizes the gas valve (V1).
10. Ignition Module sparks electrode for 1st trial ignition.
11. Ignition Module detects flame and shuts off spark electrode.
 - A. If flame is not established after the spark period.

- 1) 2nd pre-purge period.
- 2) 2nd spark.
- B. If flame is not established after the 2nd spark period.
 - 1) 3rd pre-purge period.
 - 2) 3rd spark.
- C. If flame is not established after the 3rd spark period, the module will go into a lock out, and the red LED on the ignition module will blink, and NO Heat will show in the Timer display on the oven.
- D. Main I/O board detects the Ignition Module lock out and will reset the ignition module one time by de-asserting and reasserting the call for heat Y14.
- E. The Ignition Module will repeat the ignition sequence up to 3 times again, and if a flame is not detected after this second set of 3 tries, the ignition module will lock out a second time, and the red LED on the ignition module will blink. NO HEAT will show in the timer display.
- F. To reset the Ignition Module, turn the On/Off (SW4) off and back on again.
- 12. Ignition Module continues to energize the Gas valve and combustion blower.
- 13. Ignition Module continues to monitor the flame sense.
- 14. Cavity temperature RTD1 monitored by Main I/O board at XA1 & XA2, and turns off the call for heat when cavity temperature is satisfied.

Overshoot Feature

- A. When trays of frozen product are placed in the oven, and the oven is recovering up to setpoint, the temperature in the center of the oven and the temperature in the upper corner where the temperature probe is, are going to be different. To make up for this, the first time the oven tries to reach setpoint, the control board will keep calling for heat until the temperature at the cavity temperature probe is 50°F higher than the setpoint (“augmented setpoint”). This feature automatically kicks in if the following conditions exist.
 - 1) The temperature setpoint is higher than 250°F.
 - 2) It takes longer than 8 minutes to reach setpoint.

- 3) This must be the “first call for heat cycle”.

The “first call for heat cycle” is defined as the first time the control board calls for heat after:

- a. First time a temperature setpoint is entered in cook mode.
 - a) When temperature is set from "----".
 - b) When On/Off switch is toggled and temperature is automatically recalled.
- b. When the temperature setpoint is changed.
- c. When it is detected that the door goes from being opened to closed in cook mode.

- 15. Y14 call_for_heat relay de-energizes.
- 16. Ignition Module de-energizes Gas valve (V1).
- 17. Ignition Module de-energizes Combustion blower (MTR3).

ON/OFF Switch (SW4) ON & with Call for Heat & Call for Humidity

Humidification Sequence

- 1. Humidity knob automatically changes to the mapped humidity for that setting, or humidity knob can be changed by the user (SW9 input).
- 2. Humidity knob sending signal from SW9 encoder to Main I/O board through the ribbon cable (for example 70%).
- 3. After Main I/O board senses the cavity temperature on RTD1 is within 50°F of setpoint.
- 4. Y8 Low humidity water valve, SOL2, energizes.
- 5. For Humidity Setpoint = 100%, firmware 4-24-17 and later.
 - A. Y8 Low humidity water valve remains energized continually without regulation, as long as cavity temperature does not fall below 50°F of setpoint, or does not fall below 50°F of augmented setpoint. See overshoot feature.
- 6. For Humidity Setpoints 0- 99%, firmware 4-24-17 and later (or for Humidity Setpoints 0-100%, firmware 8-11-14, 2-25-14).

NOTE: All humidity setpoints between 90% and 99% are treated as 90%.

NOTE: If the oxygen sensor is not functioning (error codes E16, E22-E23, E25-E28), oven will enter a "limp along mode" and will steam in an inefficient open loop mode at setpoints between 212°F and 220°F, and/or humidity setpoints of 100% and will steam with both water valves (Y8, SOL2 & Y5, SOL3) energized continually without regulation.

- A. Y5 High humidity water valve, SOL3 energizes.
- B. Main I/O board monitors oven humidity oxygen sensor, SW5. Then when humidity is satisfied, SW5 = setpoint.
- C. Y5 Humidity high water valve off.
- D. Y8 Low humidity water valve off.

Regulation

- 1) When oven humidity sensor, SW5 < setpoint – 10%. Y8 Low humidity water valve, SOL2, re-energizes.
- 2) And if oven humidity sensor < setpoint -20%. Y5 High humidity water valve, SOL3 re-energizes.
- 3) Y5 Humidity high water valve off.
- 4) Y8 Low humidity water valve off.

Hysteresis - Cavity vent intake motor (during cook cycle).

NOTE: Humidity Setpoints = 100%, firmware 4-24-17 and later, or Humidity setpoint = "----" if so programmed in P28 .

1. Y10 energizes to close vent (until Main I/O board detects SW1, SW2 closed position).
2. Y10 de-energizes and vent remains closed during cook.

NOTE: Humidity Setpoints 0 - 99%, with firmware 4-24-17 and later (or Humidity Setpoints 0-100%), with firmware 8-11-14, 2-25-14.

1. Main I/O board monitor oven humidity oxygen sensor, SW5, and compares it to humidity setpoint.
2. Y10 energizes to open the vent (until Main I/O board detects SW1, SW2 open position) when oxygen sensor, SW5 > Setpoint +10%.

Example

If Setpoint = 70%, if actual humidity is 80%, then open vent.

3. Y10 energizes to close the vent (until Main I/O board detects SW1, SW2 closed position) when oxygen sensor SW5 < = Setpoint.

Example

If Setpoint = 70%, if actual humidity is 70%, then close vent.

Automatic Venting

1. When Timer counts down to 30 seconds (defined in P17), then the vent will be opened to release steam in the cavity prior to the presumed opening of the door when the timer expires.
2. Y5 Humidity high water valve off.
3. Y8 Low humidity water valve off.
4. Y10 Cavity Vent Intake motor (MTR2) energizes.
5. Main I/O board monitors SW1 and SW2 for the open position, and de-energizes Y10, cavity vent intake motor.

OTHER SEQUENCES

Timer Expires (All ABC devices) AND Cook to Probe Temperature satisfied (ABCx-xxxP devices only)

1. Timer sends a signal from SW8 encoder to Main I/O board through the ribbon cable to
2. Main I/O Board either:
 - Counts down the time.

NOTE: Timer does not count down when door is open.

OR

- Monitors temperature on external meat probe thermocouple (TC2).
3. Main I/O board turns off humidity water valves Y5 and Y8 (turns off steam) typically 30 seconds before timer expires (programmed by P17 in).
 4. Main I/O board energizes on board buzzer for 5 seconds (or continuously if so programmed in P8 in). Display lights flash.
 - A. Buzzer stops when additional time/cook-to-temperature is added (turn timer knob right).
 - B. Buzzer function is muted when the knob is turned left with door shut. Display lights will still flash.
 - C. Opening the door stops the time and buzzer function.

5. Timer function (or cook-to-probe function) does not control or affect heating. Oven will continue to heat, (without humidity) after timer expires (or after cook to probe) temperature has been reached.
6. Humidity Function not re-enabled until timer is reset and/or door is opened and closed.

Door Open (SW3 open)

1. Y14 call_for_heat_low is off.
2. Y5 Humidity high water valve off.
3. Y8 Low humidity water valve off.

NOTE: At any time during operation, if door is opened, the cook timer pauses.

Electronic Motor Break (When door opens)

- A. Main board sends controls signals through ribbon cable to motor board.
- B. Amber (L1) and red (L3) LEDs turn off.
- C. The Solid State Relay (R6) de-energizes.
- D. Green colored LED (L2) indicates direction of motor and toggles its state from on to off, or off to on.
- E. Amber colored LED (L1) pulses (faint glow) to indicate that a break signal is being sent to the external solid state relay.
- F. Solid state relay (R6) pulses.
- G. Convection fan motor (MTR1), electronically breaks.
- H. Amber (L1) and red (L3) LED's off.
- I. The solid state relay (R6) OFF.
- J. Convection fan motor (MTR1) energizes.

Cold Water Condensate

NOTE: TC1 does not monitor water as it exits the oven, rather it monitors water as it exits the oven cavity. Inside the bent drain tube assembly, it mixes cooling water in as necessary to achieve proper exit temperature of the water.

1. Water inside drain assembly is monitored by Main I/O board using drain water sensor TC1.
2. When water temperature inside drain assembly is above (P25 parameter) 160°F (new bent tube drain), or 140°F (old NPT pipe drain), cold water condensate valve (SOL1) is energized. This allows cold water to mix in to achieve the proper exit temperature of drain water.

3. When water temperature inside drain assembly is below (P26 parameter) 155°F (new bent tube drain), or 130°F (old NPT pipe drain), cold water condensate valve (SOL1) is de-energized.
4. Every two hours, cold water condensate valve (SOL1) is energized for 6 seconds to ensure p-trap remains full of water. This prevents cold air being sucked into drain and into cooking cavity.

NOTE: Parameter P25 and P26 are set based on drain type, not firmware revision.

Rapid Cool Feature

1. Temperature setpoint is turned down by operator, so RDT1 temperature is now 70°F higher than the temperature setpoint.
 - A. Main board checks status of SW1 and SW2 (Cavity Vent switches).
 - 1) If switches indicate vent is closed, the cavity vent intake motor is energized.
 - 2) When switches indicate vent is fully opened, the cavity vent intake motor is de-energized.
 - B. Humidity (high flow) water valve (SOL3) is energized.
 - C. Humidity (low flow) water valve (SOL2) is energized.
2. When RDT1 temperature drops to within 70°F of the temperature setting:
 - A. Humidity (high flow) water valve (SOL3) is de-energized.
 - B. Humidity (low flow) water valve (SOL2) is de-energized.

Motor Control Board

1. Main I/O board sends signals through the ribbon cable to motor board.
2. Amber colored LED turns on to indicate that a drive signal or a brake signal.
3. Green colored LED indicates direction of the motor and toggles its state from on to off (or off to on) every 2 minutes during a cooking cycle.

NOTE: State of the onboard reversing relay changes every two minutes (indicated by LED). This reverses phases of the motor to reverse motor direction.

4. Red LED indicates presence of current in convection fan motor, and signals the main I/O board through ribbon cable.

5. Solid State Relay (R6) energizes, at a delayed on time (as programmed in P12) every 60 hertz cycle to control motor speed (fire angle control).
6. Convection fan motor (MTR1) energizes (at low, medium or high speed setting).

CIRCUIT BOARD LAYOUTS

MAIN BOARD CONNECTIONS

Meter readings for different settings on unit.

NOTE: Temperature knob presets to best set humidity. However, humidity can be adjusted.

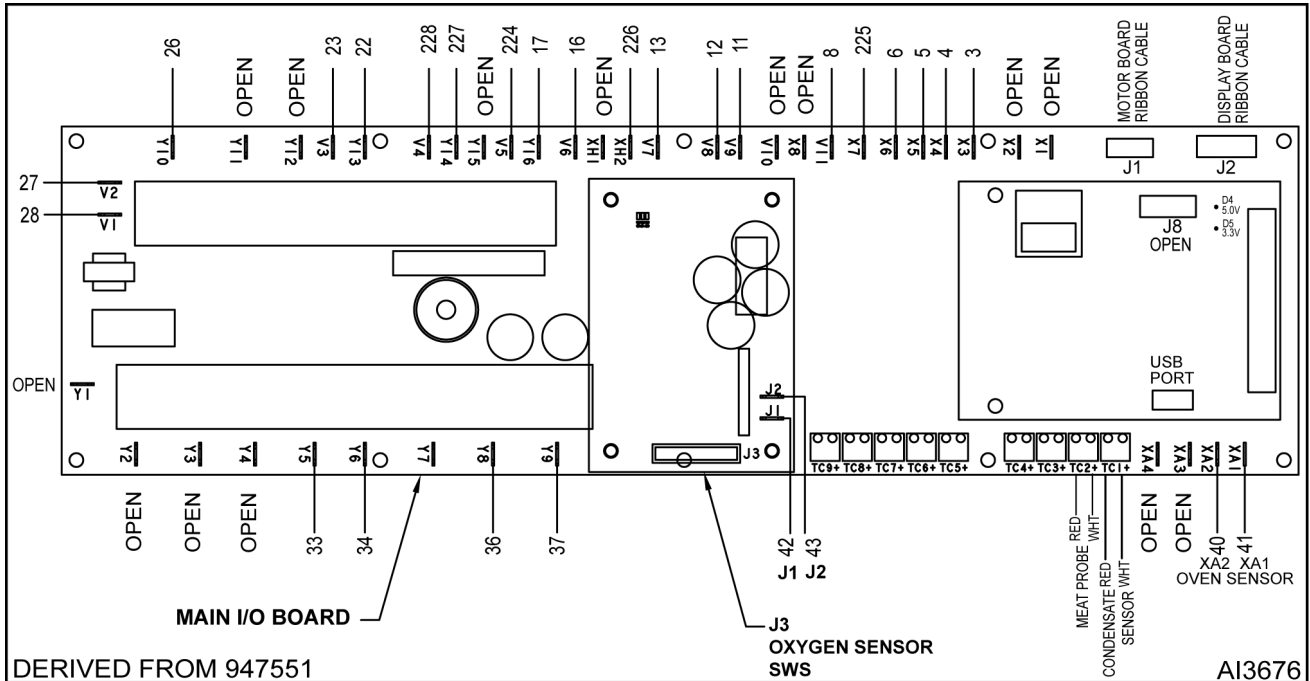

Main Control Board Connections

Oxygen Board Connections (Function)

Designation	Wire number connected	Function
J1	Wire 42	12 VAC (OXY) input
J2	Wire 43	12 VAC (OXY) (COM)
J3	Cable	Wire harness connected to Oxygen sensor (SW5)

Oxygen Board voltage readings

Designation	Reference Point	ON/OFF Switch (OFF)	ON/OFF Switch (ON)
J1	J2	0 V	12 VAC

MAIN I/O BOARD CONNECTIONS (FUNCTION)

Designation	Wire number connected	Function
J1	Ribbon Cable	Ribbon cable connection for Motor Board.

MAIN I/O BOARD CONNECTIONS (FUNCTION)		
Designation	Wire number connected	Function
J2	Ribbon Cable	Ribbon cable connection for Display Board.
TC1+	White wire	Condensate tempering probe input.
TC1-	Red wire	Condensate tempering probe input.
TC2+	White wire	External Meat probe thermocouple.
TC2-	Red wire	External Meat probe thermocouple.
V1	Wire 28	230 VAC input (from On/Off switch.)
V2	Wire 27	230 VAC (COM) input.
V3	Wire 23	12 VAC (Lite) input.
V4	Wire 228	24 VAC (IM) (COM) input.
V5	Wire 224	24 VAC (IM) input (call for heat relay supply voltage)
V6	Wire 16	24 VAC (IM) input (blower test relaysupply voltage)
V7	Wire 13	Chassis Ground input.
V8	Wire 12	24 VAC (COM) input (main board power supply)
V9	Wire 11	24 VAC input (main board power supply)
V11	Wire 8	24 VAC (IM) (COM) input.
XA1	Wire 41	Oven Sensor RDT1 input.
XA2	Wire 40	Oven Sensor RDT1 input.
X3	Wire 3	Cavity Vent Switch (SW1) input.
X4	Wire 4	Cavity Vent Switch (SW2) input.
X5	Wire 5	Hi Limit Sense Switch input.
X6	Wire 6	Door Switch input.
X7	Wire 225	Ignition Module Fault detect input.
XH2	Wire 226	Air Pressure Switch input.
Y5	Wire 33	Output for Humidity fill valve (high) relay.
Y6	Wire 34	Output for Cooling Fans (CF1, CF2 and CF3) relay.
Y8	Wire 36	Output for Humidity fill valve (low) relay.
Y9	Wire 37	Output for Condensate tempering valve relay.
Y10	Wire 26	Output for Cavity Vent Intake Motor relay.
Y13	Wire 22	Output for Cavity Light relay.
Y14	Wire 227	Output for Heat relay.
Y16	Wire 17	Output for Service Mode blower test relay.

Main Board Connection Points (Output Voltage readings)					
Designation	Reference Point	ON/OFF Switch (OFF)	ON/OFF Switch (ON)		
			Temperature Knob Set to "----" (0°F)	Temperature Knob > 80°F	Service Tests Mode
Y5	V2	0 VAC	0 VAC	230 VAC as needed Controlled by temp or humidity settings.	230 VAC
Y6	V2	0 VAC	230 VAC	230 VAC	230 VAC
Y8	V2	0 VAC	0 VAC	230 VAC as needed when temp is within 50° of setpoint. Controlled by oxygen sensor and humidity setting.	230 VAC
Y9	V2	0 VAC	230 VAC for 6 seconds when on/off switch turned on.	230 VAC for 6 seconds every 2 hours to fill ptrap, and if Drain Water Sensor Input calls for cold water.	230 VAC
Y10	V2	0 VAC	230 VAC for 15 seconds when on/off switch turned on to close vent.	230 VAC for 15 seconds controlled by oxygen sensor and humidity setting.	230 VAC for 15 seconds.
Y13	TB4-9	0 VAC	12 VAC when door is open.	12 VAC when door is open.	12 VAC when door is open.
Y14	V4	0 VAC	0 VAC	24 VAC when call for heat is needed.	24 VAC during Y17 test.
Y16	V4	0 VAC	0 VAC	0 VAC	24 VAC

MOTOR BOARD

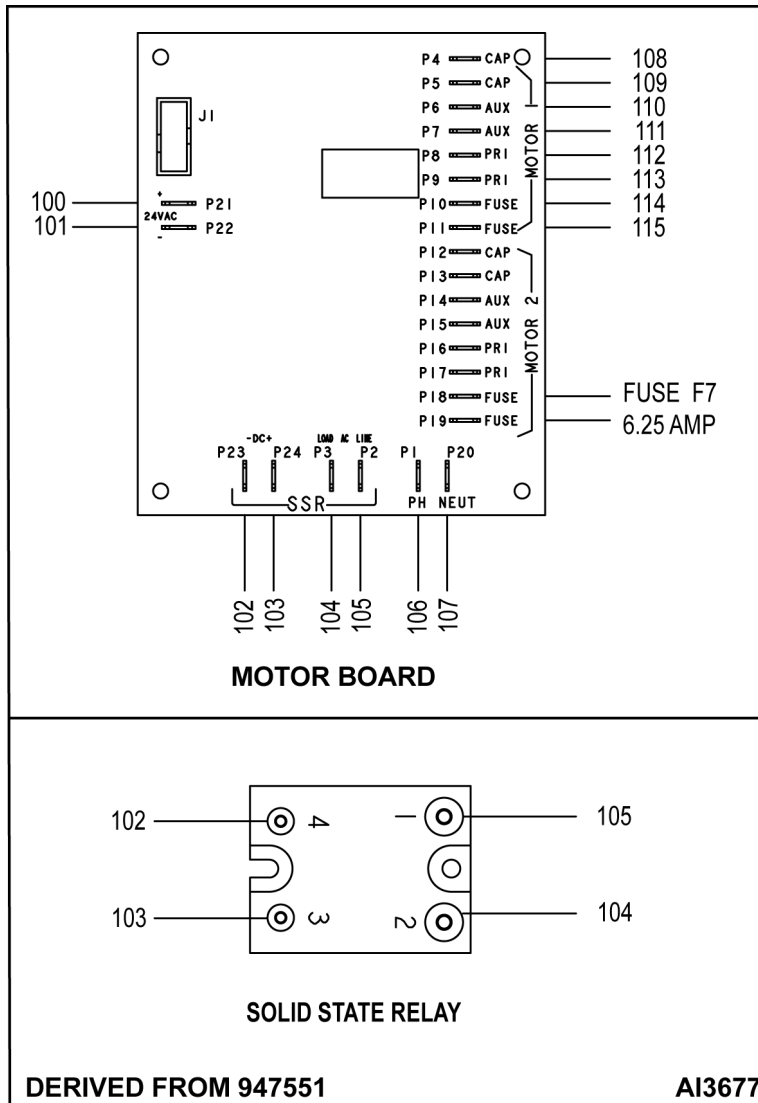

Fig. 145

IGNITION MODULE

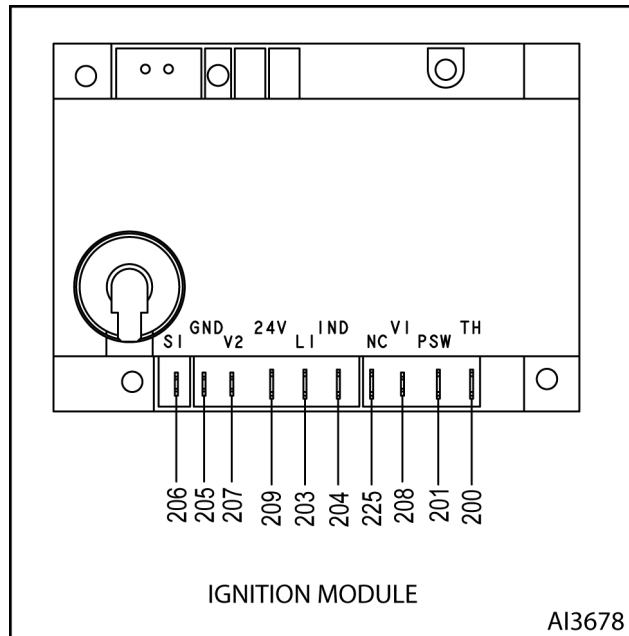

Fig. 146

Ignition Module	Description	Wire Number
S1	Remote Flame Sensor	206
GND	System Ground	205
V2	Valve Ground	207
24VAC	24 VAC Supply	209
L1	120/240 VAC Input (hot)	203
IND	Inducer Blower (output)	204
NC	Alarm (normally closed contact)	225
V1	Valve Power (Output)	208
PSW	Pressure Switch Input	201
TH / W	Thermostat Input	200
FC+	Flame Current Test Pins	None
FC-		

WIRING DIAGRAMS

TERMINAL BLOCKS and TRANSFORMER

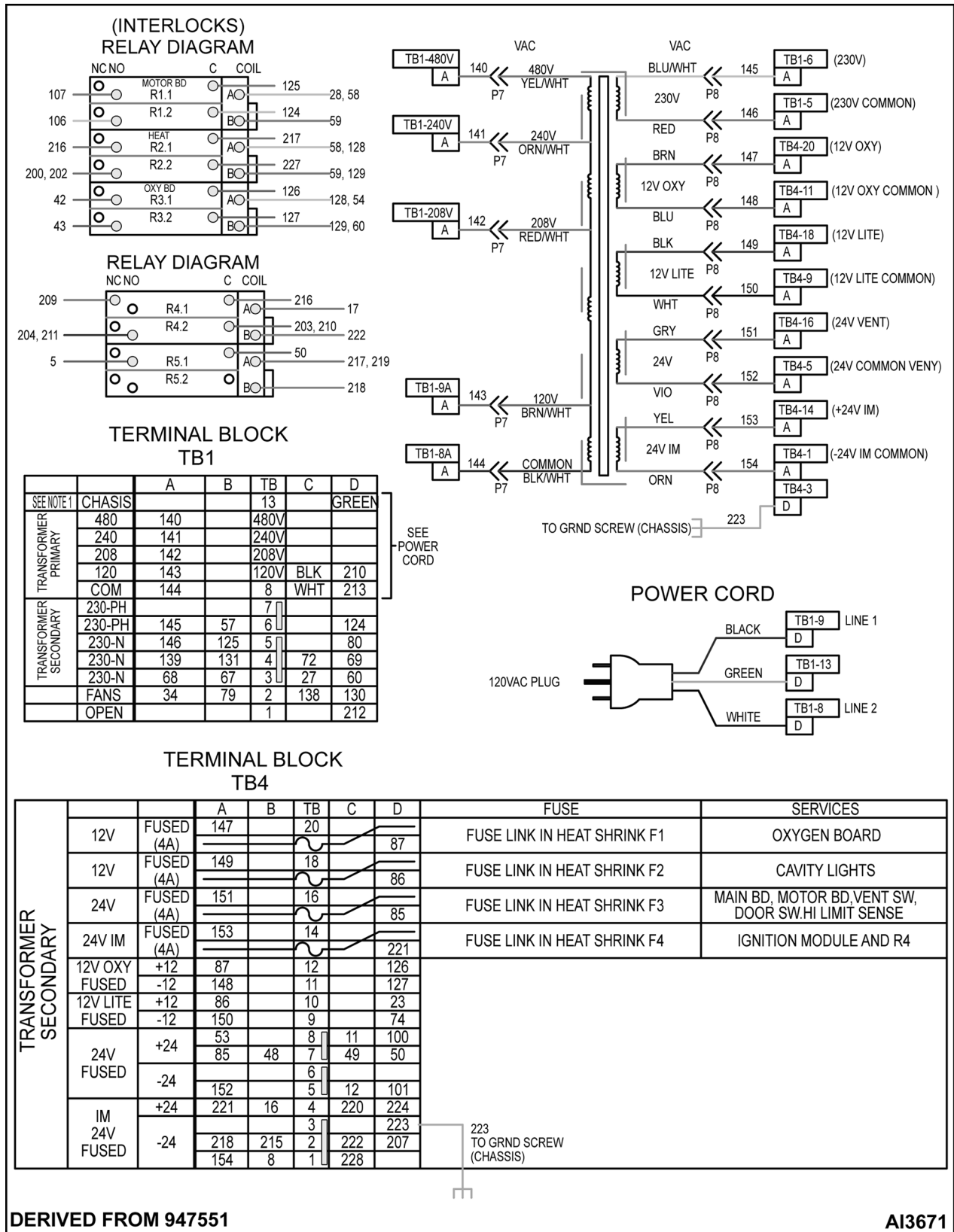

Fig. 147

MAIN BOARD

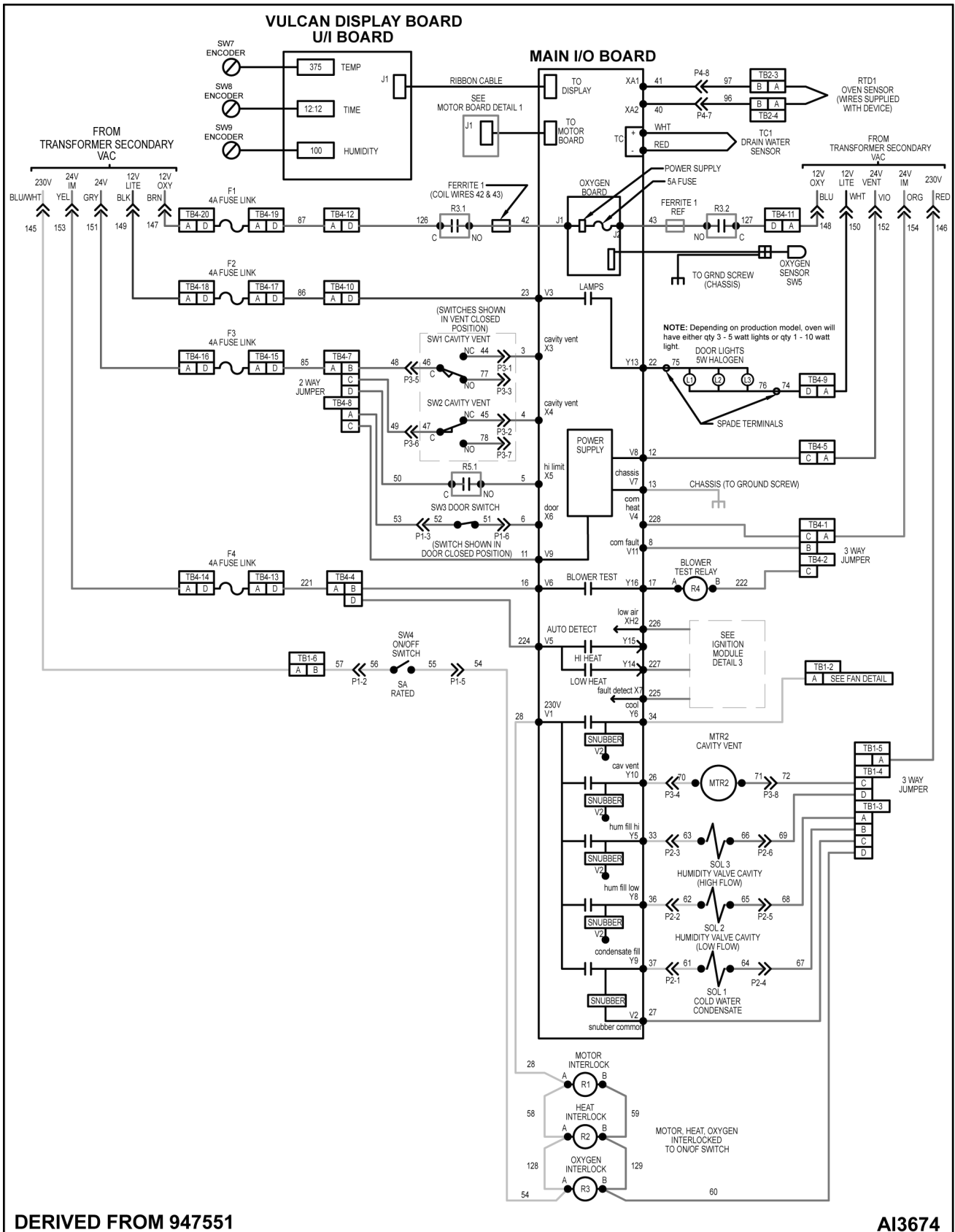

Fig. 148

MOTOR BOARD

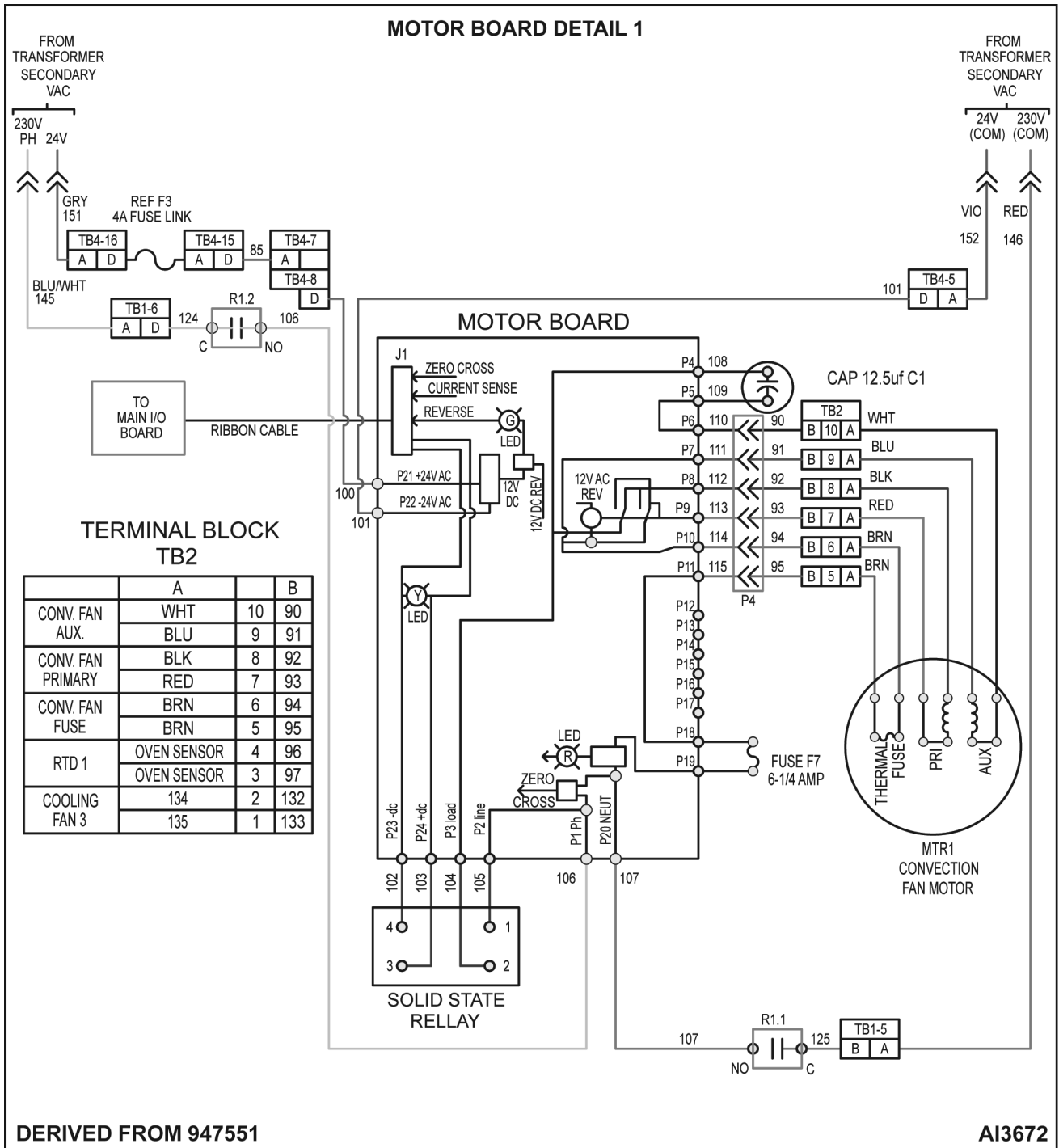
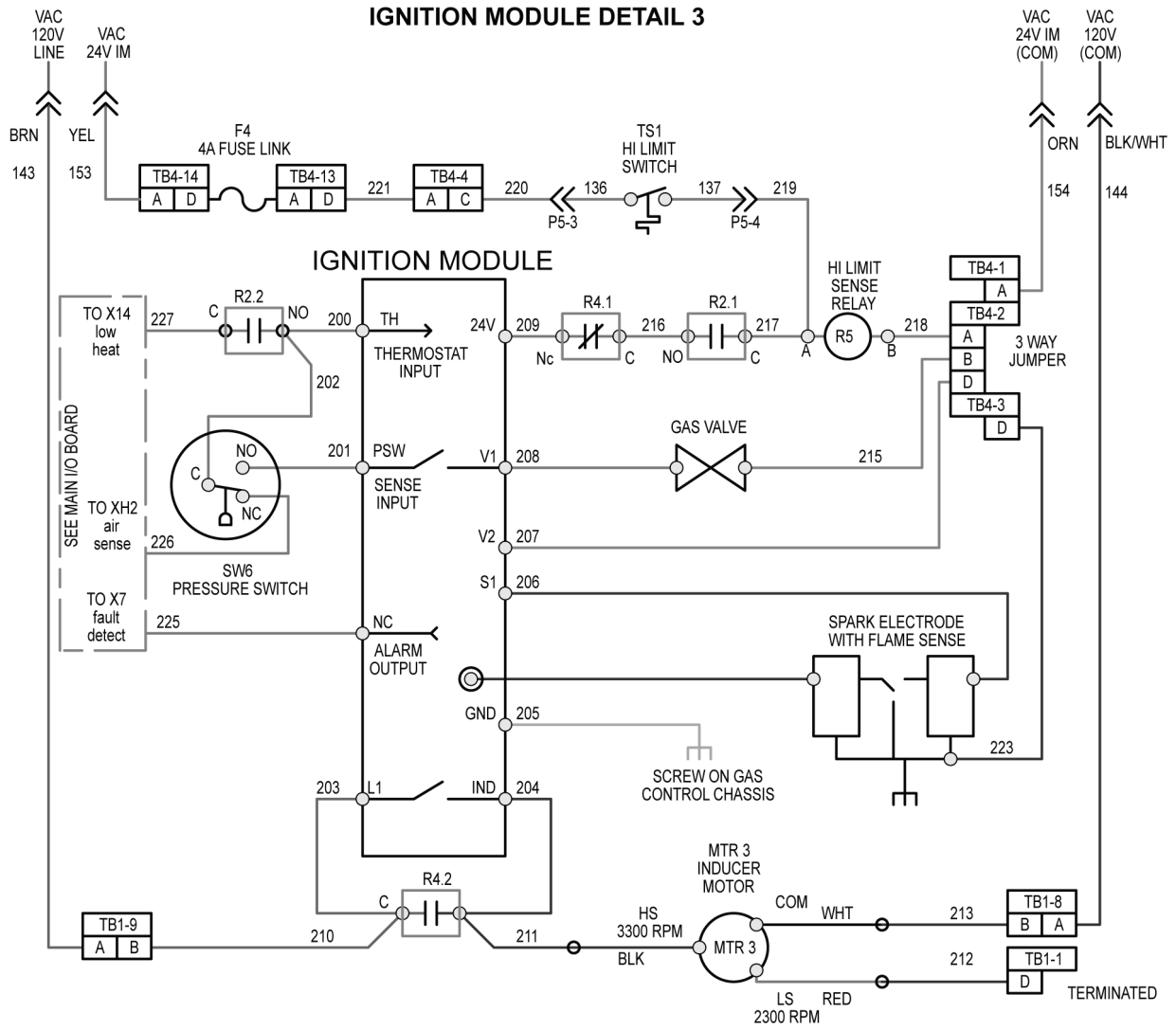

Fig. 149

IGNITION MODULE



DERIVED FROM 947551

AI3673

Fig. 150

COOLING FANS

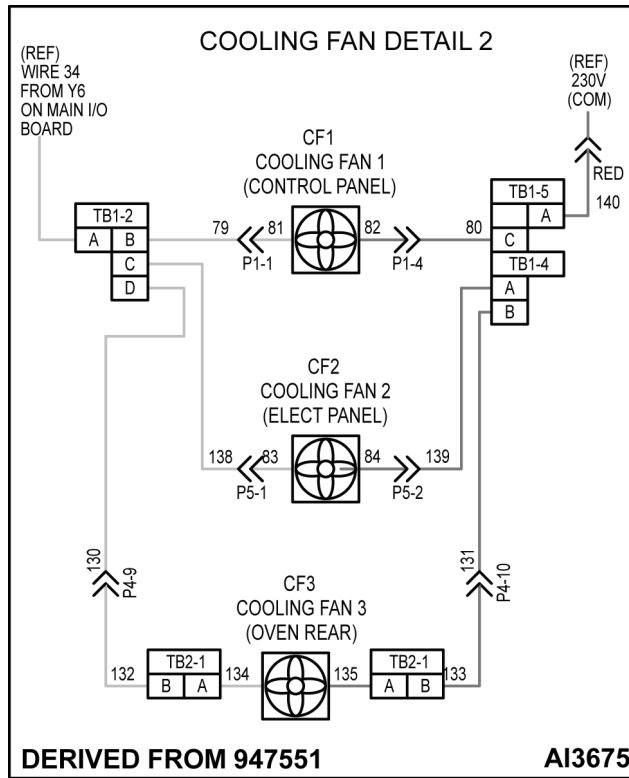

Fig. 151

DIAGNOSTICS / TROUBLESHOOTING

SERVICE MODE (1963)

Logging into Service Mode 1963

1. Turn unit on.
 - NOTE:** Oven must have no temperature set to enter Service Mode.
2. Turn Timer knob counterclockwise until Timer display shows "SEt".
3. Turn Humidity knob counterclockwise until Humidity display shows "PAS".
 - A. Timer display will show "2000".
4. Turn Timer display counterclockwise to 1963.
 - A. Timer display will flash "1963".
 - B. Timer and Humidity display will flash twice.
 - C. Humidity display changes from "PAS" to "tst" when logging into Service Mode.

NOTE: Humidity knob used to advance.

NOTE: Tests function with door open or closed.

NOTE: For some tests (Y5 - Y13), time display toggles between test number and data reading such as current or temperature.

NOTE: To view TC1, see Y9 test. To view TC2, see P21 Calibration in CONFIGURATION MODE (1972) - GAS.

Temp. Display ("---")	Description	Timer Display ("--:--")	Humidity Display ("---")
P0	Current firmware code revision (Month, day, year). Time and Humidity show example.	0424 (Month: 04, Date: 24)	17 (Year: 2017)
S5	High limit thermostat status.	HIlt	HI / CLS (Switch closed) LO / oPn (Switch open)
S6	State of Door Switch. Open / Close door to test switch.	door	HI / CLS (Switch closed) Lo / oPn (Switch open)
S10	State of O/I Switch. Toggle front panel switch to test.	AC	on / off
S11	Electric vs Gas. Auto detects if oven is gas or electric.	tyPE	Lo / gAS
rd1	Oven Cavity Temperature.	(current oven temp) E2 indicates readings out of range. 556F indicates open circuit. <40F indicates short circuit.	oVn

Temp. Display ("---")	Description	Timer Display ("--:--")	Humidity Display ("---")
o 1	Oxygen sensor power. Verifies 12VAC is supplied to Oxygen Sensor Board.	o2Pr	on/Err on - Oxygen board is powered. Err - Oxygen board is not powered.
o2	Oxygen sensor board revision number.	orREV	example: 012 (If no revision number seen - power off / on to recognize revision date.) NOTE: Revision 12 is backward compatible to ovens s/n 541083068 and before and is a required upgrade when changing a sensor.
o 3	Oxygen Board /Oxygen Sensor status. NOTE: Reported as a pair.	02bd	O0 / - <ul style="list-style-type: none"> Oxygen board not transmitting a status. Check connections. O1 / HT <ul style="list-style-type: none"> Oxygen board is heating the oxygen sensor. Wait 3 minutes for warming after power is applied. O2 / rdY <ul style="list-style-type: none"> Oxygen board is ready and transmitting humidity data from sensor. O3 / Cal <ul style="list-style-type: none"> Oxygen board can't calibrate itself. Damaged Oxygen board. O4 / Cur (Current error) <ul style="list-style-type: none"> Oxygen board can't sense current in oxygen sensor heater. Check for disconnected sensor.

Temp. Display ("---")	Description	Timer Display ("--:--")	Humidity Display ("---")
o 4	<p>Oxygen sensor data.</p> <p>Shown in % of Absolute Humidity. This value will not match the % Relative Humidity value shown on User interface at oven cavity temperatures less than 212°F.</p> <p>Same value as P33 in <u>CONFIGURATION MODE (1972) - GAS.</u></p> <p>NOTE: Combine the numbers in the two displays to get the complete percentage.</p>	<p>051</p> <p>Combine the two numbers to get 51.2 %</p>	.2
o5	Reports duty cycle of oxygen sensor heater regulation.	duty	Example: 33
o6	Reports ramp input given to oxygen board.	rAanP/0005	
o7	Reports condensation time phase input given to oxygen board.	PHAS/0001	
F1	<p>Convection fan Test.</p> <p>1. Checks fan speeds 3 through 7.</p> <p>Visually check for change in fan speed.</p>	SPd / Ion	oFF, 3, 4, 5, 6, 7
	<p>2. Checks current sensing of motor.</p> <p>Visually check for display to change from loFF to Ion in Timer display.</p>	<p>SPd / Ion</p> <p>SPd / loFF</p>	
	<p>3. Checks breaking of motor.</p> <p>Visually check for convection fan breaking to a stop and not coasting to a stop.</p>	SPd / loFF	

Temp. Display ("---")	Description	Timer Display ("--:--")	Humidity Display ("---")
F3	<p>Convection Fan Reverse Test.</p> <p>Turn humidity knob to initiate test. Note direction of fan. For example, clockwise.</p> <p>Turn humidity knob to reverse motor. Note direction of fan has changed. For example, counterclockwise.</p> <p>NOTE: Turning humidity knob too quickly during breaking sequence, will cause oven to beep.</p>	<p>rEV</p> <p>Ion / loFF</p>	<p>HI / Lo</p>
Y5	<p>Humidity High flow Water Valve.</p> <p>When turned on, water will flow out of water atomizer.</p> <p>NOTE: Valve flow rate = 15 liters / hour (.25 liter / min).</p>	<p>H2HI</p> <p>When on, Timer display toggles between H2H1 and a value to indicate solenoid is energized.</p> <p>Expected value = 6 ± 1</p> <p>NOTE: Wait 10 seconds for proper value reading in timer display.</p> <p>NOTE: When Timer displays "=Err", indicates that the valve is not drawing the proper current.</p>	<p>on / oFF</p>
Y6	<p>Cooling fans.</p> <p>Fan 1 (control panel), fan 2 (display panel), fan 3 (oven rear).</p>	<p>CFAn / (Current Sense value)</p> <p>When on, Timer display toggles between CFan and a value to indicate fans are energized.</p> <p>Expected value = approximately 99 for 3 fans, 66 for 2 fans.</p> <p>NOTE: When Timer displays "=Err", indicates that the fans are not drawing the proper current.</p>	<p>on / oFF</p>
Y8	<p>Humidity Low flow Water Valve.</p> <p>When turned on, water will flow out of water atomizer.</p> <p>NOTE: Valve flow rate = 15 liters / hour (.25 liter / min).</p>	<p>H2Lo</p> <p>When on, Timer display toggles between H2Lo and a value to indicate solenoid is energized.</p> <p>Expected value = 6 ± 1</p> <p>NOTE: Wait 10 seconds for proper value reading in timer display.</p> <p>NOTE: When Timer displays "=Err", indicates that the valve is not drawing the proper current.</p>	<p>on / oFF</p>

Temp. Display ("---")	Description	Timer Display ("--:--")	Humidity Display ("---")
Y9	<p>Water drain Condensate valve.</p> <p>When turned on, water will flow out drain.</p> <p>NOTE: Valve flow rate = 300 liters / hour (5 liters / min).</p>	<p>H2dr / Drain Temp</p> <p>When on, Timer display toggles between three things. H2dr which is the name of the test, a value to indicate solenoid is energized (settles at a value of 6 ±1 and the drain tempering probe's (TC1) temperature).</p> <p>NOTE: When Timer displays "=Err", indicates that the valve is not drawing the proper current.</p>	<p>on / oFF</p>
Y10	<p>Cavity Vent Intake.</p> <p>Current sense and Vent operation test.</p> <ol style="list-style-type: none"> 1. Checks state of vent switches. 2. Checks rotation of vent motor, quarter turn at a time. <p>NOTE: Properly check cavity vent intake by turning humidity knob between oPn and CLS a minimum of 4 times to get full rotation.</p> <ol style="list-style-type: none"> 3. Times rotation of quarter turn, to verify vent switches seat properly on shaft. 4. Checks for current feedback to verify motor is energized. 	<p>VEnt / CLSd</p> <p>SPIIn / =5</p> <p>Display toggles. SPIIn indicates switches are in spinning state. "=5" is an approximate number which indicates motor is energized properly.</p> <p>When complete: VEnt / oPEn</p> <p>NOTE: "Err/=5", switches are in an error state, see <u>ERROR CODES</u>.</p> <p>NOTE: When timer display "=Err" indicates that the vent motor is not drawing the proper current.</p>	<p>Humidity display shows CLS. CLS, turn humidity knob to initiate test.</p> <p>Display counts up to 15 seconds, if operating properly.</p> <p>When complete: Humidity knob will read oPEn</p> <p>NOTE: Counts past 15 indicate switches have not seated properly, Err displays after 75 seconds, Test continues to run.</p>
Y13	Oven cavity door light.	<p>LtE</p> <p>when on, Timer display toggles between LtE and a value to indicate lights are energized.</p> <p>Expected values:</p> <p>75 for 3 lights</p> <p>50 for 2 lights</p> <p>25 for 1 light</p> <p>0 for no lights on</p>	<p>on / oFF</p>
Y16	<p>Blower test / Air Pressure Switch.</p> <p>(Timer display will initially read "FAIL", until blower has successfully turned on and up to speed and pressure switch has been opened. Timer display will then read "PASS".)</p>	<p>blo</p> <p>FAIL / PASS</p>	<p>on / oFF</p>

Temp. Display ("---")	Description	Timer Display ("--:--")	Humidity Display ("---")
Y17	Ignition sequence test (gas only).		on / oFF
		IGn	oFF
	Resets ignition module faults.	blo0 to blo9 rSt0 to rSt9	on Turn humidity knob on to initiate test.
	Tests ignition module gas valve pressure switch, induction blower, and spark ignitor.	trY NOTE: trY1 is the spark from spark ignitor. NOTE: If trY does not display, wait approximately 30 seconds for error codes to generate. If error codes generate, refer to ERROR CODES (1963).	
	Heat test rate of temperature rise. NOTE: If cavity temperature is above 400°F, oven will beep and turn off test. Turn Humidity knob to turn off beep. NOTE: If test fails, for example, gas turned off to unit, test will stop, and error code will be shown. If error codes generate, refer to ERROR CODES (1963).	102F / Heat 115F / PASS	tst When heat test passes, turn Humidity knob counter clockwise to turn test off.
Pb	Reports the press of the push button encoder. (ABCx-xxxP devices only)	--- (not pressed) PUSH (Timer pressed)	--- (not pressed) PUSH (Hum pressed)
d1	Display Test - assure led light segments operate.	Temperature, Timer, Humidity displays sequence thru dots and digits 0 - 9. (Example: ..., 000, 111, etc.)	oFF / on
HUn gAL	Humidity Water Counter. NOTE: Same value as P19 in <u>CONFIGURATION MODE (1972) - GAS.</u>	Example: 0009	Example: 999 Example: Total gallons: 9,999.
Cnd gAL	Condensate Tempering Water Counter. NOTE: Same value as P20 in <u>CONFIGURATION MODE (1972) - GAS.</u>	Example: 0009	Example: 999 Example: Total gallons: 9,999.

Temp. Display ("---")	Description	Timer Display ("--:--")	Humidity Display ("---")
HRS	<p>Cooking Hours.</p> <p>NOTE: Same value as P18 in <u>CONFIGURATION MODE (1972) - GAS</u>.</p> <p>(Hour counter does not increment in idle mode.)</p>	Example: 0009	<p>Example: 999</p> <p>Example: Total hours: 9,999.</p>
LOg	(Refer to <u>ERROR CODES</u> .)		
E0 thru E21	(Refer to <u>ERROR CODES</u> .)		

Logging out of Service Mode 1963

1. Turn Temperature knob counterclockwise until "---" displayed.

ERROR CODES

In cook mode, the oven always checks for errors. The oven does not check for errors in idle mode, (all displays show ----). All errors are stored into a log in SERVICE MODE (1963). Some errors are considered critical, that the oven cannot operate and if detected, everything is shut down, error number is displayed, and oven beeps continually.

NOTE: E6 error is the exception to the rule, and is the only error logged during idle time.

To turn off continuous beep, toggle on/off switch. If condition still exists, error will reappear immediately. If error beep turns back on, turn Timer knob counterclockwise, back to idle mode "---".

NOTICE

ERRORS 0 - 2 below are "critical" errors. Oven will not function in this condition. All processes are stopped and oven is shut down.

Some errors are considered non-critical, where something requires service, but oven can still cook. Some of these errors are displayed in operator interface, so customer knows to call for service. Other non-critical errors are logged as a diagnostics tool for service.

When an error code is logged, the hour that the error occurred is recorded. The hours in the log are cooking hours. Cooking hours are the number of hours the oven has been in use. Cooking hours do not increase during idle time (all displays show ----). So if a school uses an oven 6 hours a day, 5 days a week, the cooking hours will increase 30 hours a week.

Logging into Service Mode 1963

1. Turn unit on.
2. Turn Timer knob counterclockwise until Timer display shows "SEt".
3. Turn Humidity knob counterclockwise until Humidity display shows "PAS".
 - A. Timer display will show "2000".
4. Turn Timer display counterclockwise to 1963.
 - A. Timer display will flash "1963".
 - B. Timer and Humidity display will flash twice.
 - C. Humidity display changes from "PAs" to "tst" when logging into Service Mode.
5. Turn Temperature knob clockwise through all tests in service mode, until "HRS" is displayed in the Temperature display.

This displays the current number of cooking hours in the Timer and Humidity displays. Make a note of the hour listed. This is important so that you can tell how long it has been since the error has occurred.

To read the current number of hours

- A. With HRS displayed in the temperature display.
 - B. 0009 in the Timer display.
 - C. 999 in the humidity display.
 - D. The oven would have 9,999 cooking hours.
6. Turn Timer knob clockwise one more click, then "LOg" is displayed in the Temperature display.

There are two ways error codes are stored, sequential log and error bucket.

Sequential log: A quick timed ordered list on errors recorded.

Error buckets: Each bucket, E0...E21, displays an individual error and every hour that the error occurred.

How to read sequential Log

When Log is shown in Temperature display, sequential error log is being displayed. The last stored error is shown in the Timer display. Then the Timer display, in conjunction with the Humidity display toggles the hour count when error occurred.

Sequential Log

1. With Log displayed in the temperature display.
2. Timer Display toggles between E1 and 0009.
3. Humidity display flashing 999
4. Means that an E1 error occurred at cooking hour 9,999.

This is a sequential log. To view the next error recorded, turn Timer knob clockwise. If no more errors have been recorded, Timer displays "ErrS" and Humidity displays "End". If multiple errors have been recorded, "--]" will be displayed in Temperature display when Timer knob is turned. The next error in the sequential log is shown in the Timer display. Then the Timer display in conjunction with the humidity display toggles between error code and hour in which the error occurred.

NOTE: As the sequential log stores multiple error logs, only view the last few error codes to know what errors have occurred to prevent oven from working properly.

How to Read Error Buckets

To view bucket list, turn Temperature knob clockwise to start error buckets, starting at E0. If no errors have been recorded for E0, then Temperature displays "E0 (error code)", Timer displays "ErrS", Humidity displays "End". If no errors are displayed in error bucket, turn Temperature knob clockwise to next error.

If errors are recorded in error bucket, Temperature displays "E0 (error code)", Timer and humidity displays oven hour count the error last occurred. If multiple errors have been recorded, "--]" will be displayed in Temperature display when Timer knob is turned clockwise, the oven will display each recorded event and associated hour count. The next hour count is shown in Timer and Humidity displays. To view multiple hours recorded, continue turning Timer knob clockwise. Timer knob will show "ErrS" and Humidity display will show "End" when all recorded hours have been displayed.

NOTE: Multiple errors can be recorded during the same hour. Turning the Humidity knob clockwise will skip hour by hour, not displaying each individual recorded event.

- E0** High Limit Error (Critical Error): Oven overheats, tripping high limit thermostat, and removes voltage from ignition module.
- E1** Convection Fan Motor Error (Critical Error): Motor Board does not sense current to motor. Possible causes: 1) Convection fan has overheated and fan's thermal fuse has tripped, or 2) motor board's 6-1/4 fuse amp has been blown.
- E2** RTD Probe Error (Critical Error): Probe RTD readings are out of range indicating a main board problem.
- E3** (Future Use.)
- E4** Controls Compartment Ambient Error: Operating temperature of controls has exceeded recommenced temperature limits for more than 15 minutes.
- E5** Drain Tempering Probe Error: Drain tempering probe readings are out of the 32°F to 250°F range.

- E6** Convection Fan Current Error: Control board reads current to convection fan motor, when convection fan should be off.
Error E6 is the only error that can be logged during idle mode.
- E7** Auto Electric or Gas Detection Error: Control board cannot auto detect type of unit or state of auto detect pin has changed.
- E8** Ignition Error: Ignition Module Error Checking Problem.
1. Ignition module inoperable.
 2. Improper sensing of X7 (fault) and XH2 (pressure switch) input to main board.
 - Oven "may" heat in this condition, but Combi's Main board cannot sense ignition faults.
- E9** Ignition Error: Ignition Module, flame sensed before call for heat.
- Pre-ignition error.
 - Fenwal Module red light '2' flash.
- E10** Ignition Error: Ignition Module Lock Out Fault.
- Pre-ignition. Failure to ignite gas after 3 sparks.
 - Fenwal Module red light '3' flash.
- E11** Ignition Error: Air flow fault 1.
Blower or AP switch problem.
- Pre-ignition air pressure not up to speed.
 - Fenwal Module red light '1' flash.
- E12** Ignition Error: Air flow fault 1 or Control Fault.
1. Blower or AP switch problem.
 - Post ignition air pressure drops out while burning.
 - Fenwal Module Red light '1' flash.
 2. Internal control fault inside to Fenwal ignition module.
 - Pre-ignition
 - Fenwal Module Red Light Steady 'on'.
- E13** Ignition Error: Flame dropout Detection.
Fenwal re-ignites after gas supply restored.
No fault 'flash' but oven is not heating in this condition.
- Post ignition flame drops out before controller set temperature is satisfied.
- E14** Logs an E14 error if USB is not functioning on main board. (Requires IAP 6.21.)
- E15** Vent Error: Either vent motor has a problem and cannot rotate, or the vent switches are out of adjustment and cannot tell vent motor when to stop its rotation at the open or closed position. This means the system cannot humidify efficiently. Although switches should seat into position within 15 seconds for a quarter turn, error will not be logged until vent motor runs 75 seconds without completing.
- E16** For 4-24-17 firmware revisions and above: E16 inactive, replaced with E22 – E28.
For 8-11-14, 2-25-14 firmware revisions: In cook mode, where oxygen sensor/ oxygen sensor board has fallen out of its ready status.
1. Stuck in warming.

- 2. Communication error.
- 3. Internal oxygen board heating or calibration error.
- E17** (Future Use.)
- E18** In cook mode, where oxygen sensor board has lost 12V supply.
- E19** (Future Use.)
- E20** **Cooling Fan Dropout:** Current not sensed in one or more of the cooling fans. Check cooling fans to ensure fans are functioning properly.
- E21** Logs an error when part of the motor speed control zero cross circuit on either the motor board or main board is inoperable. (Logs error when 60 seconds has passed without seeing a 60Hz zero cross signal.)
- E22** Log event created when condition persists for more than 60 seconds for "no COMM". Communication dropout between oxygen & main boards. Indicates board error (if together with no power, an E18 is logged instead).
- E23** Log event created when condition persists for more than 60 seconds for "bad COMM". Communication unrecognized status received from oxy board. Indicates board error.
- E24** Log event created when condition persists for more than 60 seconds for "bad reading", "stuck" at 100% absolute humidity, for more than 60 seconds. Indicates damaged oxygen sensor.
- E25** Log event created when condition persists for more than 60 seconds for "under heating":
 - Undershoot of the sensor's heater regulation. Status 01 is returned for more than 60 seconds after first o.k. status (after warm-up complete) indicating intermittent electrical noise interference. (Rev. 12 amber LED, Rev. 11, red LED, comes back on for more than 60 seconds after warm-up complete.)
 - Stuck in warming. Status 01 is returned for more than 3 minutes before the first o.k. status when the board is reset or following a COMM error. (Rev. 12 amber LED, Rev. 11 red LED, never turns off after power up.)
- E26** Log event created when condition persists for more than 60 seconds for "damaged oxygen board". Status 03 returned from the oxy board indicating on board IC's cannot calibrate themselves.
- E27** Log event created when condition persists for more than 60 seconds for "cannot heat sensor". Status 04 returned from the oxy board indicating no heater current and possibly an open sensor, unplugged sensor or intermittent connection.
- E28** Log event created when condition persists for more than 60 seconds for "Over-heating".
 - Overshoot of the sensor's heater regulation. Status 05 returned from the oxy board for more than 60 seconds indicating intermittent electrical noise interference. (Rev. 12 oxygen board's red LED comes on for more than 60 seconds, after warm-up complete.)

NOTE: E28 error requires Rev. 12 oxygen sensor board. When using Rev. 11 oxygen sensor board, the overheating condition is logged as E25.
- E29** Logs E29 error when RTD reads abnormally low <40F indicating a damaged sensor.

Logging out of Service Mode 1963

1. Turn Temperature knob counterclockwise until "---" displayed.

Error Download to USB Flash Drive

NOTE: It may be necessary to down load the error log to USB flash drive, and send it to warranty administrator for further review.

1. Enter SERVICE MODE (1963).

NOTE: Must be in service test mode. Inserting the flash drive during cook, configuration or idle mode will represent a different function.

2. Insert USB flash drive into oven USB port. Display will show “USB dLog n_y”.

NOTE: If something other than Usb Flsh n_y is displayed, then Refer to USB ERROR MESSAGES.

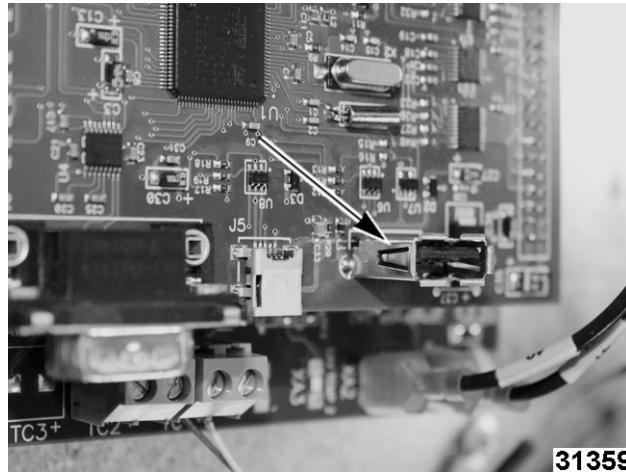

Fig. 152

3. Select y (turn the humidity knob to the right) to initiate the log download. Selecting n will cancel back to test mode.
4. If y is selected, the Hum display will briefly show Yes, then will begin showing a percentage complete from 0 – 100 as the log files are downloaded.
 - The download may take several seconds, depending on how many errors are in the log. When download is complete, Hum display will briefly show "don", then the oven returns to test mode.
 - USB drive will now contain a root folder called “ABCCombi”, with a subfolder named with the version number for the software on the oven (e.g. “081114” or “042417”). Inside this subfolder will be the log files. These include:
 - Log_All.txt – This is a simply formatted text file comprising all of the errors in the log (from most to least recent). The oven hour and minute counter and water counters at the time downloaded are also included at the top. A brief header is inserted before error entries for a new/different hour.
 - Log_En.txt (for each error E0 - En) – These are formatted the same as Log_All.txt, but include only the error type specified by En (analogous to the E0 - En tests within test mode described above).
 - Log_JSON.txt – This file contains the error log contents in a simple JSON text format. Some miscellaneous additional data (oven hour and minute counter and water counters) are also included.

OVEN TROUBLESHOOTING



⚠ WARNING

Certain procedures in this section require electrical test or measurements while power is applied to the machine. Exercise extreme caution at all times and follow Arc Flash procedures. If test points are not easily accessible, disconnect power and follow Lockout/Tagout procedures, attach test equipment and reapply power to test.

Quick Overall Check

The ABC7 Combi oven automatically records error conditions that may occur during use. Also, the Service Mode provides a quick way of checking the condition of the oven. It is recommended that any time an ABC7 oven is to be serviced, the service tech starts by running all tests in SERVICE MODE (1963) and to look at the error log and make note of any recent error codes that have been saved.

Troubleshooting Using Error Codes

Check which ERROR CODES are logged.

NOTE: When an error has been corrected, that error code still remains in the log. It is important to note what the current cooking hour is and what cooking hour the error code was recorded.

1. The current number of cooking hours on the oven is 100.

NOTE: Temperature display shows HRS, Timer display is flashing 0000 and the humidity display is flashing 100.

2. The school uses the oven 6 hours a day.
3. Error E1 happened at hour 75.
4. This means the error occurred 4 working days earlier.

Error Code	Symptom	Possible Cause	Action
E0	Oven does not operate. When the error occurs, the oven shuts down and E0 shows in the temperature display along with a constant error beep.	<ol style="list-style-type: none"> 1. High limit thermostat open. 2. High limit sensing relay (R5). 3. Fuse F4, fuse link in terminal block. 4. Oven installed with not enough clearance. 	<ol style="list-style-type: none"> 1. Verify High limit shaft is turned clockwise until it stops. 2. <u>SERVICE MODE (1963)</u> : <ol style="list-style-type: none"> A. Run (S5) to check the current status of the high limit. B. Run (rd1) to check the current temp of the oven cavity. 3. In <u>CONFIGURATION MODE (1972) - GAS</u>: <ol style="list-style-type: none"> A. Check the setting of (P15). <ol style="list-style-type: none"> 1) If the setting of (P15) is set to 482, the high limit must be the 582-degree high limit thermostat. <p>NOTE: The older version of the high limit thermostat had yellow painted on the tip of the shaft.</p> 4. Check to make sure there is restriction to air flow for cooling and no other heat source that would raise the temperature of the oven.
E1	Oven does not operate. When the error occurs, the oven shuts down and E1 shows in the temperature display along with a constant error beep.	<ol style="list-style-type: none"> 1. Convection fan motor is getting too hot and its thermal overload trips. 2. 6.25-amp fuse (F7) blows on the Motor Drive Board. 3. Cooling fan F3 not running or running in the wrong direction. 4. R1 interlock relay. 5. r6 solid state relay. 6. Motor Drive board. 7. C1 capacitor. 	<ol style="list-style-type: none"> 1. In <u>SERVICE MODE (1963)</u>: <ol style="list-style-type: none"> A. Run (F1) Convection Fan test. B. Run (F3) Convection Fan reverse test. C. Run (Y6) Cooling fans test. <ol style="list-style-type: none"> 1) The Timer display alternates between CFan and a value. A value of 99 means all three fans are running. 2) Make sure cooling fan F3 is blowing in towards the convection fan motor. 2. With no power applied, check to see if the convection fan turns freely. 3. Check to make sure there is restriction to air flow for cooling and no other heat source that would raise the temperature of the oven.

Error Code	Symptom	Possible Cause	Action
E2	Oven does not operate. When the error occurs, the oven shuts down and E2 shows in the temperature display along with a constant error beep.	1. RTD Probe. 2. Main board.	1. In <u>SERVICE MODE (1963)</u> : A. Run (rd1) to check the reading from the temperature probe. NOTE: If a reading of E2 is seen the value is out of range and possible damage board. B. Perform <u>TEMPERATURE SENSOR (RTD1) TEST</u> . C. Replace main board.
E4	Oven not operating properly (intermittent or erratic).	1. Cooling fan F2 not running or running in the wrong direction.	1. In <u>SERVICE MODE (1963)</u> : 2. Run (Y6) Cooling fans test. A. The Timer display alternates between CFan and a value. A value of 99 means all three fans are running. B. Make sure cooling fan F2 is blowing down, drawing air through the electrical panel. 3. Check to make sure there is restriction to air flow for cooling and no other heat source that would raise the temperature of the oven.
E5	Uses too much water, or does not temper drain water.	1. Drain tempering probe. 2. Water drain condensate valve. 3. Main board.	1. In <u>SERVICE MODE (1963)</u> : 2. Run (Y9) Water drain condensate valve test. NOTE: When the test is running, the Timer display toggles between three things: H2dr, which the name of the test, the drain tempering probes temperature reading, and a value that indicates the valve is energized (should be a value of 6 plus or minus 1).
E6	Not cooking properly. (Convection fan not working.)	1. Motor board. 2. Solid State relay.	1. In <u>SERVICE MODE (1963)</u> : A. Run (F1) Convection Fan test. 1) Check LEDs on motor board. • If red LED is on when the motor is not running, replace motor board. • If yellow LED is on and motor does not run, replace Solid State Relay.
E7	A gas oven thinks it's electric.	1. Main board.	1. In <u>SERVICE MODE (1963)</u> : A. Run (S11) Auto Detect test.

Error Code	Symptom	Possible Cause	Action
E8	<p>IGNITION ERROR</p> <ol style="list-style-type: none"> Ignition module's LED is on steady. No Heat is displayed and there is a dot in the upper left hand corner of the temperature display. 	<ol style="list-style-type: none"> Wiring problem between main board and pressure switch, or pressure switch and Ignition module. Pressure switch. Ignition Module. Main board. 	<ol style="list-style-type: none"> In <u>SERVICE MODE (1963)</u>: Run (Y17) Ignition sequence test to see if burner lights. <ul style="list-style-type: none"> If the burner lights, check wiring. If burner does not light, check LED on Ignition module. <ul style="list-style-type: none"> If LED is steady on replace Ignition module.
E9	<p>IGNITION ERROR</p> <ol style="list-style-type: none"> Ignition module's LED 2 flash. (Senses flame before call for heat.) No Heat is displayed and there is a dot in the upper left hand corner of the temperature display. 	<ol style="list-style-type: none"> Flame Sensor. Gas Valve. Main board. 	<ol style="list-style-type: none"> In <u>SERVICE MODE (1963)</u>: Run (Y17) Ignition sequence test to see if burner lights. <ul style="list-style-type: none"> If the burner lights, make sure flame goes out when test is turned off. If operation appears normal but another E9 error comes up, check flame sensor.
E10	<p>IGNITION ERROR</p> <ol style="list-style-type: none"> Ignition module's LED 3 flash. (Fails to ignite or fails to sense flame.) No Heat is displayed and there is a dot in the upper left hand corner of the temperature display. 	<ol style="list-style-type: none"> Gas supply to oven not on. Oven's internal gas valve turned off. Oven's internal gas valve not operating properly. Air in gas supply line. Spark ignitor. Flame Sensor. Ignition module. 	<ol style="list-style-type: none"> Check gas supply to oven. Check switch at internal gas valve. In <u>SERVICE MODE (1963)</u>: Run (Y17) Ignition sequence test to see if burner lights. <ul style="list-style-type: none"> If burner lights, flame sensor. If burner does not light: <ul style="list-style-type: none"> Spark ignitor. Gas valve. Ignition module.
E11	<p>IGNITION ERROR</p> <ol style="list-style-type: none"> Ignition module's LED 1 flash. (Pressure switch never makes.) <p>No Heat is displayed and there is a dot in the upper left hand corner of the temperature display.</p>	<ol style="list-style-type: none"> Pressure switch. Draft inducer motor. Ignition module. 	<ol style="list-style-type: none"> If the ignition module's LED is doing a 1 flash, perform <u>DRAFT INDUCER TEST</u>.

Error Code	Symptom	Possible Cause	Action
E12	<p>IGNITION ERROR</p> <ol style="list-style-type: none"> Ignition module's LED is on steady. (Control Fault.) Ignition module's LED 1 flash. (Pressure switch drops out.) No Heat is displayed and there is a dot in the upper left hand corner of the temperature display. 	<ol style="list-style-type: none"> Pressure switch. Draft inducer motor. Ignition module. 	<ol style="list-style-type: none"> If the ignition module's LED is doing a 1 flash, perform <u>DRAFT INDUCER TEST</u>. Run (Y17) Ignition sequence test to see if burner lights. <ul style="list-style-type: none"> If burner does not light, check LED on Ignition module. If LED is steady on replace Ignition module.
E13	<p>IGNITION ERROR</p> <ol style="list-style-type: none"> Ignition module's LED is off. No Heat is displayed and there is a dot in the upper left hand corner of the temperature display. 	<ol style="list-style-type: none"> Gas supply. Flame sensor. Ignition module. 	<ol style="list-style-type: none"> Check Gas supply. Run (Y17) Ignition sequence test to see if burner lights. <ul style="list-style-type: none"> If burner lights, check flame sensor. If burner does not light, check LED on ignition module. If LED is steady on replace Ignition module.
E15	<p>Poor cooking, error dot in the upper left hand corner of the humidity display.</p>	<ol style="list-style-type: none"> Setscrew that holds damper shaft to vent motor is loose. Vent motor. Vent switches. Vent blocked. 	<ol style="list-style-type: none"> Perform <u>CAVITY VENT SWITCH TEST AND ADJUSTMENT</u>. <p>NOTE: Typically, when there is a vent problem, E15, motor is spinning but shaft is not turning, which prevents the detent from shutting off the switch.</p> Inspect vent tube to verify it's not blocked.

Error Code	Symptom	Possible Cause	Action
<p>E16 firmware revisions: 8-11-14 or 2-25-14 Only</p>	<p>Does not steam in Combi mode. Error dot in the upper left hand corner of the humidity display.</p>	<ol style="list-style-type: none"> 1. Oxygen sensor. 2. Oxygen sensor board. 3. Main board. 4. Missing ferrite. 	<ol style="list-style-type: none"> 1. In <u>SERVICE MODE (1963)</u>: <ol style="list-style-type: none"> A. Run (o3) Oxygen board / Oxygen sensor status. <p>O0 / oFF</p> <ul style="list-style-type: none"> • Oxygen board not transmitting a status. • Check connections. • Run (o1) oxygen sensor power test. • If test passes, (board has power, but cannot communicate), replace Oxygen sensor board. <p>O1 / HT</p> <ul style="list-style-type: none"> • Oxygen board is heating the oxygen sensor. • Wait 3 minutes for warming after power is applied. <ul style="list-style-type: none"> • Check sensor connections. • Make sure Ferrite is in place. • Check routing of cable going to Oxygen Sensor. • Replace sensor. <p>O2 / rdY</p> <ul style="list-style-type: none"> • Oxygen board is transmitting humidity data from sensor. <p>O3 / Cal</p> <ul style="list-style-type: none"> • Oxygen board can't calibrate. • Replace Oxygen board. <p>O4 / Cur (Current error)</p> <ul style="list-style-type: none"> • Oxygen board can't sense current in oxygen sensor heater. • Check for disconnected sensor. • Check for damaged extension cable. • Replace sensor.
<p>E18</p>	<p>Does not steam in Combi mode. Error dot in the upper left hand corner of the humidity display.</p>	<ol style="list-style-type: none"> 1. Fuse F1 (fuse link in terminal block). 2. Fuse F8 (on Oxygen board). 3. R3 relay. 	<ol style="list-style-type: none"> 1. Check fuses.

Error Code	Symptom	Possible Cause	Action
E20	No obvious symptom.	1. Cooling fan.	<ol style="list-style-type: none"> 1. In <u>SERVICE MODE (1963)</u>: 2. Run (Y6) cooling fan test. <p>NOTE: The Timer display alternates between CFan and a value. A value below 65 means at least one fan is not running.</p>
E21	<p>Motor speed control error.</p> <p>Motor only runs on maximum speed, but other speeds won't work.</p>	<ol style="list-style-type: none"> 1. Main board. 2. Motor board. 3. Ribbon Cable. 	<ol style="list-style-type: none"> 1. In <u>SERVICE MODE (1963)</u>: <ol style="list-style-type: none"> A. Run (F1) motor speed test at speed 7 (maximum speed). Verify Amber LED on motor board lights up. B. Run (F1) motor test at speed 3 (slowest speed). C. Verify Amber LED on motor board lights up. D. Amber light on at speed 7, but not on at speed 3, 4, 5, or 6, indicates that part of the motor speed control circuit (on either the motor board or main board) is inoperable.
E22	<p>Does not steam in Combi mode.</p> <p>Error dot in the upper left hand corner of the humidity display.</p>	<ol style="list-style-type: none"> 1. Intermittent electrical noise. 2. Incorrect alignment of the 10 pin header (oxygen board to main board). 3. Oxygen sensor board. 4. Main board. 	<ol style="list-style-type: none"> 1. In <u>SERVICE MODE (1963)</u>: 2. Run (o1) power test. <ol style="list-style-type: none"> A. Verify "00/on". 3. Run (o3) Oxygen board/ Oxygen sensor status. <ol style="list-style-type: none"> A. 02/rdY status: If power is on and status reads ready, there was a prior communication dropout that is now restored. B. 00/oFF status: If power on and status reads off, then there is a NO communication, oxygen board is not transmitting a status. <ul style="list-style-type: none"> • Check the alignment of the 10-pin header. • Replace oxy board. • Replace main board.

Error Code	Symptom	Possible Cause	Action
E23	<p>Does not steam in Combi mode.</p> <p>Error dot in upper left hand corner of humidity display.</p>	<ol style="list-style-type: none"> 1. Intermittent noise. 2. Oxygen sensor board. 	<ol style="list-style-type: none"> 1. In <u>SERVICE MODE (1963)</u>: 2. Run (o1) power test. Verify "00/on". 3. Run (o3) Oxygen board/ Oxygen sensor status. <ol style="list-style-type: none"> A. 02/rdY status: If power is on and status reads ready, there was a prior communication error (of unrecognized error received) that is now restored. B. No status: Bad communication (unrecognized status) received from oxygen board. <ul style="list-style-type: none"> • Replace oxygen board.
E24	<p>Does not steam in Combi mode.</p> <p>Error dot in the upper left hand corner of the humidity display.</p> <p>"Actual" humidity reads 100% when oven is not steaming.</p>	<ol style="list-style-type: none"> 1. Damaged oxygen sensor extension cable. 2. Oxygen sensor plug not fully seated. 3. Damaged oxygen sensor "stuck" at 100%. 	<ol style="list-style-type: none"> 1. Check for damage to Oxygen sensor extension cable. Hot surfaces or sharp edges can damage the wires. 2. Check for solid connection of oxygen sensor to mating connector. 3. Wipe out excess moisture and water droplets from the inside of the cavity. 4. Open the door. 5. In <u>SERVICE MODE (1963)</u> : 6. Run (F1) motor speed test at speed 7 (maximum speed) for approximately 1 minute to evacuate moisture from cavity. 7. Run (o4) Oxygen sensor data test. It should read <20.0% (depending on altitude) with completely dry cavity in a typical room. <ul style="list-style-type: none"> • Replace oxygen sensor. • Replace oxygen sensor extension cable.

Error Code	Symptom	Possible Cause	Action
E25 / E28	<p>Does not steam in Combi mode.</p> <p>Error dot in the upper left hand corner of the humidity display.</p>	<ol style="list-style-type: none"> 1. Damaged Oxygen Sensor extension cable. 2. Intermittent electrical noise. 3. Oxygen sensor plug not fully seated. 4. Wire routing. 5. Missing ferrite. 6. Oxygen sensor. 7. Oxygen sensor board. 	<ol style="list-style-type: none"> 1. Check for damage to oxygen sensor extension cable. <ol style="list-style-type: none"> A. Hot surfaces or sharp edges can damage the wires. 2. Check for solid connection of oxygen sensor to mating connection. 3. Check for proper routing of cables. 4. Verify ferrite is in place. 5. In <u>SERVICE MODE (1963)</u> run 03 oxygen board/oxygen sensor status. <ol style="list-style-type: none"> A. Status 02/rdY. <ul style="list-style-type: none"> • If status reads ready there was a prior underheat or overheat condition that has now cleared. B. Status 01/HT. <ul style="list-style-type: none"> • Wait 3 minutes after any kind of power on. • If status <u>continually</u> reads 01, underheating, there is an inability for the sensor-board pair to regulate the sensor's internal heater. C. Status 05/HT. <ul style="list-style-type: none"> • If status <u>continually</u> reads 05, overheating, there is an inability for the sensor-board pair to regulate the sensor's internal heater. <p>NOTE: Oxygen sensor heater regulation is sensitive to intermittent electrical noise. Sporadic E25 or E28 errors can be expected. Only replace the following components if the o3 test reports the status 01 or status 05 <u>continually</u>.</p> 6. Replace oxygen sensor extension cable. 7. Replace oxygen sensor. 8. Replace oxygen sensor board.

Error Code	Symptom	Possible Cause	Action
E26	Does not steam in Combi mode. Error dot in the upper left hand corner of the humidity display	1. Oxygen Sensor board.	<ol style="list-style-type: none"> 1. In <u>SERVICE MODE (1963)</u>: 2. Run (o1) power test. Verify 00/on. 3. Run (o3) Oxygen board/ Oxygen sensor status. <ul style="list-style-type: none"> • 02/rdY status: If power is on and status reads ready, condition is cleared and no action needed. • 03/cal status: Oxygen board can't calibrate itself. Replace Oxygen board.
E27	Does not steam in Combi mode. Error dot in the upper left hand corner of the humidity display.	<ol style="list-style-type: none"> 1. Damaged Oxygen sensor extension cable. 2. Oxygen Sensor plug not fully seated. 3. Oxygen sensor. 4. Oxygen sensor board. 	<ol style="list-style-type: none"> 1. Check for damages to the Oxygen sensor extension cable. <ul style="list-style-type: none"> • Hot surfaces or sharp edges can damage the wires. • Check for solid connection of Oxygen sensor to mating connector. 2. Run (o3) Oxygen Sensor Status test in <u>SERVICE MODE (1963)</u>. <ol style="list-style-type: none"> A. Status 04: oxygen board is sensing an open circuit to the sensor. <ul style="list-style-type: none"> • Replace oxygen sensor extension cable. • Replace oxygen sensor. • Replace oxygen sensor board.
E28	Refer to <u>E25</u> .		
E29	High limit trips. Heat contactor does not turn off. Runaway oven heat.	1. Oven temperature sensor damaged and reports an abnormally low reading (for example <40° F).	<ol style="list-style-type: none"> 1. In <u>SERVICE MODE (1963)</u>: <ol style="list-style-type: none"> A. Run "rd1" to check the reading from the temperature probe. <p>NOTE: rd1 reading of <40°F indicates a short.</p> B. Perform <u>TEMPERATURE SENSOR (RTD1) TEST</u>. 2. Check wiring at TB2. 3. Replace oven temperature sensor.

Troubleshooting by Symptom

It is highly recommended that you check the error log, and run the test available in reference.

SYMPTOM	POSSIBLE CAUSE
Oven completely inoperative. No display on display board or erratic display.	<ol style="list-style-type: none"> 1. Facilities main circuit breaker open. 2. Oven power cord unplugged. 3. Fuse F3. 4. Incorrect wiring of On/Off switch. 5. Ribbon cable going from Main board to Display board not seated correctly. 6. Display board inoperative. 7. Transformer T1 malfunctioned. 8. Control board inoperative.
Oven does not operate. Display is on.	<ol style="list-style-type: none"> 1. Encoder malfunction. 2. In <u>SERVICE MODE (1963)</u>: <ol style="list-style-type: none"> A. Check error log for EO, E1, and E2 errors. NOTE: If any of the 3 errors are logged, follow <u>TROUBLESHOOTING USING ERROR CODES</u>. B. Run (S6) Door test. 3. Check that the jumper (J5) on back of Display Board is on the correct set of pins. NOTE: Jumper should be on two pins closest to the edge of board. This is 5V position.
Oven operates. Door closed and convection fan inoperative.	<ol style="list-style-type: none"> 1. In <u>SERVICE MODE (1963)</u>: <ol style="list-style-type: none"> A. Check error log for E1 errors. NOTE: If any of the 3 errors are logged, follow <u>TROUBLESHOOTING USING ERROR CODES</u>. B. Run (S6) Door test.
Oven operates. Door closed and oven cavity lights inoperative.	<ol style="list-style-type: none"> 1. Reset control by powering oven off and unplugging from the wall outlet. Then restarting. 2. Check fuse F2. 3. In <u>SERVICE MODE (1963)</u>: <ol style="list-style-type: none"> A. Run (Y13) Oven Cavity door light test. <ol style="list-style-type: none"> 1) Run (Y13) Oven Cavity door light test. <ul style="list-style-type: none"> • Check 12 volts from transformer. • Main Board. B. If only one light out. <ul style="list-style-type: none"> • Halogen light burned out.

SYMPTOM	POSSIBLE CAUSE
<p>Oven operates. Door closed. Oven convection fan operates. Oven does not heat.</p> <p>Possible error messages on Timer Display.</p> <ul style="list-style-type: none"> • "No Heat" • "Door" 	<ol style="list-style-type: none"> 1. In <u>SERVICE MODE (1963)</u>: <ol style="list-style-type: none"> A. Check error log for E8 through E13 errors. <p>NOTE: Follow troubleshooting called out for the error found.</p> 2. Run (S6) Door test.
<p>Oven cavity vent inoperative.</p> <p>There is a dot in the upper left corner of the humidity display.</p>	<ol style="list-style-type: none"> 1. Perform <u>CAVITY VENT SWITCH TEST AND ADJUSTMENT</u>. 2. Inspect the vent tube to make sure it is not blocked in some way.

SYMPTOM	POSSIBLE CAUSE
<p>No steam or not enough steam.</p>	<ol style="list-style-type: none"> 1. Check water supply to unit. Verify water supply from source to back of unit. 2. Inspect the gray colored extension cable from to oxygen sensor to oxygen sensor board for damage. 3. Check the Error Log for occurrences of E22-E28 and follow troubleshooting accordingly. 4. In <u>SERVICE MODE (1963)</u> verify (check PO) software revision is 4-24-17 or higher. Upgrade if necessary. 5. Verify proper operation of Oxygen sensor. <ol style="list-style-type: none"> A. Run (o1) Oxygen sensor power test. Verify power "on." B. Run (o3) Oxygen Board/sensor status test. Verify "rdy" status. C. Wipe out any standing water droplets, and run (F1) fan test with an open door for 1-2 minutes to evacuate any moisture. D. Run (o4) Oxygen sensor Data. It should read <20.0% (depending on altitude) with completely dry cavity in a typical room. 6. Verify water flows out of atomizer. <ol style="list-style-type: none"> A. Run (Y5) High Humidity test. Verify start/stop. B. Run (Y8) low Humidity test. Verify start/stop. <p>NOTE: Debris/excessive lime build up can clog valves.</p> 7. Verify proper cavity vent operation. <ol style="list-style-type: none"> A. Run (Y10) Cavity Vent test. <p>NOTE: Maladjustments causing intermittent vent stuck open, means steam and heat loss during cook.</p> 8. Verify proper door switch operation. <ol style="list-style-type: none"> A. Run (S6) Door test. <p>NOTE: Maladjustments causing intermittent door switch chattering, means steam and heat are turned off during cook.</p> 9. In cook mode, check "actual" oven temperature compared to setpoint. Turn temperature knob clockwise one indent only. <ul style="list-style-type: none"> • Oven must be within 50°F of setpoint or "augmented setpoint" for water valves to come on (for steam function).

SYMPTOM	POSSIBLE CAUSE
	<ul style="list-style-type: none"> • Frozen product, valve issues, stuck (open) vent, underpowered (voltage/gas pressure) oven could all contribute to a >50°F drop in temperature. <p>10. Verify timer isn't expired.</p> <p>NOTE: When timer expires, the steam but not heat turns off.</p> <p>11. Verify humidity knob is NOT set to "---" during cook cycle.</p> <ul style="list-style-type: none"> • Humidity setting of "---" means "no steam mode". • Disable P28 in <u>CONFIGURATION MODE (1972) - GAS</u>. <p>12. Check incoming voltage.</p> <p>13. Check gas pressure.</p> <p>14. Replace oxygen sensor.</p> <p>NOTE: Refer to: <u>CHECK OXYGEN SENSOR DATE CODE (REPLACEMENT SENSORS)</u>.</p>
<p>Excessive moisture in oven. Water runs continually from atomizer when not cooking.</p>	<p>1. Check water supply.</p> <p>A. Cycle water supply to unit off and back on again.</p> <p>NOTE: Pressure conditions can hold water valves on.</p> <p>B. Check for proper orientation of dual humidity valve.</p> <p>NOTE: Water tubes to the top and electrical connections to the bottom. Correct valve orientation prevents a water "stuck on" condition.</p> <p>C. Check for water pressure regulator malfunction.</p> <p>2. Check the following in <u>SERVICE MODE (1963)</u>:</p> <p>A. Verify the start/stop of the water flow out of atomizer.</p> <ol style="list-style-type: none"> 1) Run (Y5) High Humidity test. 2) Run (Y8) low Humidity test. <p>NOTE: Debris can get stuck in valve and hold it open.</p> <p>B. Verify proper cavity vent operation.</p> <ol style="list-style-type: none"> 1) Run (Y10) Cavity Vent test. <p>NOTE: Maladjustments causing intermittent vent stuck closed, means heat humidity cannot escape during cooking.</p>

SYMPTOM	POSSIBLE CAUSE
<p>Incorrect heat / Oven temperature does not match setpoint.</p>	<ol style="list-style-type: none"> 1. In <u>CONFIGURATION MODE (1972) - GAS</u>: Check P1 and P24. 2. Perform <u>TEMPERATURE CALIBRATION</u>. 3. In <u>SERVICE MODE (1963)</u>: <ol style="list-style-type: none"> A. Run (Y5) High Humidity test. B. Run (Y8) Low Humidity test. C. Run (F1) Convection Fan test. D. Run (S6) Door test. E. Run (Y17) Ignition Sequence test. (Check rate of raise.) 4. Perform <u>DRAFT INDUCER TEST</u>. 5. Heating circuit malfunction. <p>NOTE: Remember that the overshoot feature engages during the first call for heat, and will overshoot the setpoint temporarily.</p>
<p>Uneven Baking.</p>	<ol style="list-style-type: none"> 1. In <u>SERVICE MODE (1963)</u>: <ol style="list-style-type: none"> A. Run (F1) Convection Fan test. B. Run (F3) Convection Fan reverse test. C. Run (Y10) Cavity vent intake test. 2. Check intake vent and exhaust vents for blockage. 3. With no power applied, check to see if the convection fan turns freely. 4. Incorrect air baffle position. 5. Poor seal on door.
<p>Temperature of drain water too high or too much drain water.</p>	<ol style="list-style-type: none"> 1. In <u>CONFIGURATION MODE (1972) - GAS</u>. <ol style="list-style-type: none"> A. Adjust parameter P25 and P26 (temperature based tempering). <ul style="list-style-type: none"> • Settings must match the drain type. • Settings can be further adjusted to suite customer requirements. <p>OR</p> B. P27 can be enabled for continuous time based tempering. 2. In <u>SERVICE MODE (1963)</u>: <ol style="list-style-type: none"> A. Run (Y9) Water drain condensate valve test. <ul style="list-style-type: none"> • Check for proper operation of drain valve TC1 sensor.

SYMPTOM	POSSIBLE CAUSE
<p>Convection Fan not running.</p>	<ol style="list-style-type: none"> 1. In <u>SERVICE MODE (1963)</u>: <ol style="list-style-type: none"> A. Check (P0) Firmware revision. <ul style="list-style-type: none"> • If earlier than 08-11-14 follow <u>FIRMWARE UPDATE PROCEDURE</u> B. Run (F1) Convection Fan test. <ul style="list-style-type: none"> • If red LED is on when the motor is not running, replace motor board. • If yellow LED is on and motor does not run, replace Solid State Relay.
<p>Cook-to-Probe knob feature not working (push button not functional).</p> <p>NOTE: (ABCx-xxxP devices only) Identified by the presence/absence of the socket on the front panel beneath the humidity knob.</p>	<ol style="list-style-type: none"> 1. In cook mode, Press and HOLD timer knob for approximately 3 seconds to toggle from the Timer Mode to the Cook-to-Probe Mode. 2. In <u>CONFIGURATION MODE (1972) - GAS</u>: <ol style="list-style-type: none"> A. Check P29 for proper set up. 1972 P29 enables multiple functions. Probe UI and fan UI must be separately enabled. Scroll timer knob to view P_UI then use humidity knob to enable. 3. In <u>SERVICE MODE (1963)</u>: <ol style="list-style-type: none"> A. Perform (pb) test for push button encoder functionality.
<p>Cook to probe not working correctly.</p> <p>Buzzer buzzed too early when cooking with probe.</p> <p>Buzzer never buzzes in cook to probe mode.</p> <p>Probe readings too high, too low, or vary wildly.</p> <p>Probe always reads about room temperature and won't change.</p>	<ol style="list-style-type: none"> 1. In cook mode, Press and HOLD timer knob for approximately 3 seconds to toggle from the Timer Mode to the Cook-to-Probe Mode as indicated by F shown in timer display. 2. Perform <u>EXTERNAL MEAT PROBE THERMOCOUPLE CALIBRATION</u>. 3. Inspect probe and probe wire for damage. 4. Check that probe is fully seated in socket on front panel. 5. Check TC2 connection at main board.
<p>Motor speeds are not changing (push button not functional).</p> <p>NOTE: (ABCx-xxxP devices only) Identified by the presence/absence of the socket on the front panel beneath the humidity knob.</p>	<ol style="list-style-type: none"> 1. In cook mode, Press and HOLD humidity knob for approximately 3 seconds to toggle from the Humidity Mode to the Fan Speed Mode. 2. In <u>CONFIGURATION MODE (1972) - GAS</u>: <ol style="list-style-type: none"> A. Check P29 for proper set up. 1972 P29 enables multiple functions. Probe UI and fan UI must be separately enabled. Scroll timer knob to view F_UI then use humidity knob to enable. 3. In <u>SERVICE MODE (1963)</u>: <ol style="list-style-type: none"> A. Perform (pb) test for push button encoder functionality.

SYMPTOM	POSSIBLE CAUSE
<p>Motor speeds are not changing (Push button functional).</p> <p>Motor only runs on maximum speed, but other speeds do not work.</p>	<p>NOTE: In cook mode, motor speed changes only take effect when the display defaults back to humidity mode. Also, in cook mode, set temperature is mapped to a humidity and fan speed 3. Changes in set temperature can reset motor to default speed F3.</p> <ol style="list-style-type: none"> 1. Verify in <u>CONFIGURATION MODE (1972) - GAS</u>, P29 is enabled. 2. Motor relay malfunction (asynchronous turn-on feature malfunction). 3. Main board malfunction (zero cross function, check for E21 error). 4. Motor board malfunction (zero cross function, check for E21 error). 5. Ribbon cable malfunction.
<p>Speed settings need changed.</p>	<ol style="list-style-type: none"> 1. P12 changes speed settings for F1 and F2.
<p>Door too hard to close or pops open during steaming.</p>	<ol style="list-style-type: none"> 1. Perform <u>DOOR TO CONTROL PANEL ALIGNMENT</u>.

IGNITION CONTROL MODULE TROUBLESHOOTING

IGNITION CONTROL MODULE TROUBLESHOOTING

LED DIAGNOSTIC INDICATOR CODES		
LED	Code	Possible Error Codes
LED "OFF"	No Fault	None
LED "ON"	Control Fault	E8 or E12
'1' Flash	Air Flow Fault	E11 or E12
'2' Flash	Flame Fault No Call For Heat	E9
'3' Flash	Ignition Module Lockout	E10
NOTE: LED will briefly illuminate when oven is turned on.		NOTE: Check the error log for any of these codes.