

Upright Reach-Ins

BOTTOM MOUNTED CONDENSING UNIT (EB SERIES)

Refrigerators / Freezers / Dual Temps



The Bottom Mounted Upright Reach-In series offers temperature combinations and door variations in a bottom breathing design. Its deep cabinet interior is perfect for full-size baking sheet pans. It comes in solid, glass, full door, half door and drawer variations.



Blizzard R290

EPA/DOE approved, all-in-one, slide-out cooling cartridge.



Digital Control

Easy settings with audio and visual overheat alarm.



ECM Fan Motors

Electronically commutated motors require less energy.



All Stainless Steel

High quality finish with 2.5" thick thermal insulation.



Door Lock

Pre-installed, tamper-resistant, heavy-duty tumbler.



Vacuum Relief Valve

Equalizes cabinet pressure for smooth door re-entry.



Ridge-Lined Gasket

Heavy-duty door gaskets snap out/in for easy cleaning.

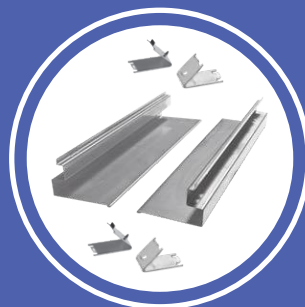

Sheet Pan Racks

Optional sheet pan rack assembly fits full-size pans..



Other Features

Self-closing door, LED lighting, 3" or 5" swivel casters.

Bottom Mount Upright Reach-In Glass Door Refrigerators – EB Series



Bottom Mounted Condensing Unit



EBGR1



EBGNR2



EBGR2

Cabinet Construction

- Heavy duty stainless steel interior / exterior with rounded corners for a hazard-free workspace.
- Open spaced interior with no walls between compartments.
- Galvanized steel top, bottom and rear.
- 2.5" thick high density polyurethane insulation.
- Four 5" swivel casters with locks on front set. Leg stabilizers included.

Refrigeration System

- Bottom mounted, self-contained, fully detachable Blizzard R290 condensing unit uses environmentally friendly, EPA-compliant R290 refrigerant with zero (0) Ozone Depletion Potential (ODP) and three (3) Global Warming Potential (GWP). Blizzard R290 is easily replaceable and requires no on-site brazing.
- Electronically commutated (ECM) fan motors achieve rapid cooling with less energy consumption.
- Full-length air duct and airflow guard ensure optimal cold air circulation.
- Air circulation guard keeps floor vents from obstruction.
- Time-initiated and temperature-terminated auto defrost cycle for seamless operation.
- Large capacity, corrosion-resistant condenser and evaporator coils.
- Self-maintaining, energy-efficient condensate drain pan requires no external drains or electric heaters.
- High performance, auto-reverse condenser fan motor supports compressor ventilation and condenser coil cleaning.
- Pressure relief devices allow rapid cabinet re-entry.
- Pre-wired and ready to plug, 115V/60Hz/1Ph, NEMA 5-15P.

Lighting

- Shielded LED bar lighting with on/off switch provides bright, high color illumination at lower heat output.

Doors

- Low emissivity double glass panes reflect UV rays for efficient cooling.
- Matte finish aluminum frames.
- Frame heaters prevent exterior moisture build up.
- Self-closing with adjustable torsion system for a positive seal.
- Snap-in magnetic gasket for ease of cleaning.
- High strength, die-cast handles.
- Pre-installed locks keep your items safe from theft.
- Field reversible.

Shelving

- Four epoxy coated, steel wire shelves per section.
- Height adjustable stainless steel clips.

Temperature Control

- Multi-function digital controller with easy to read LED display.
- Factory preset temperature, 35°F. Temp-set range from 33°F to 54°F.
- Audible overheat protection alarm for compressor and condenser coil.

Options

- Additional shelving.
- Baking sheet pan racks.
- 3" swivel casters with locks.
- 3.5" – 6" height-adjustable and interchangeable legs.
- Left hinged door.

↔ = Interior Dimensions ← → = Exterior Dimensions

ABS Legs



Two additional front adjustable stainless steel clad ABS legs provide extra stability when opening and closing door.

Vacuum Relief



The vacuum relief valve equalizes cabinet pressure for rapid door re-entry.



Equipped with 9 ft long NEMA 5-15P plug.

Side View

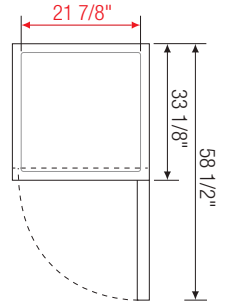
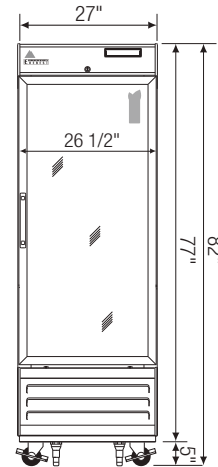
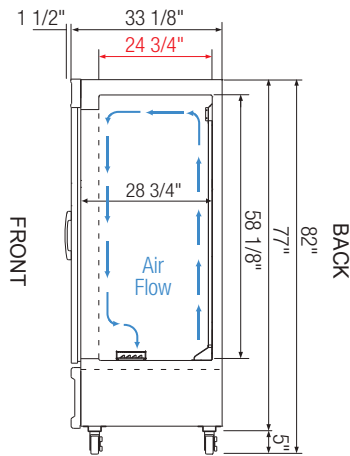

EBGR1

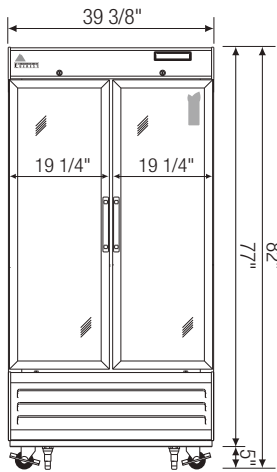

EBGNR2

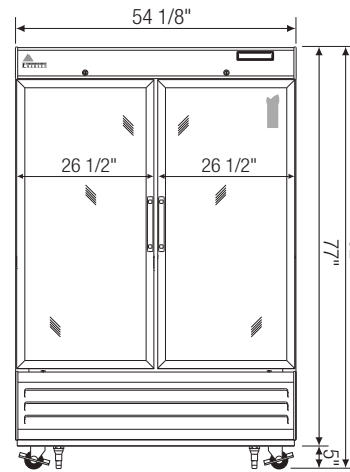
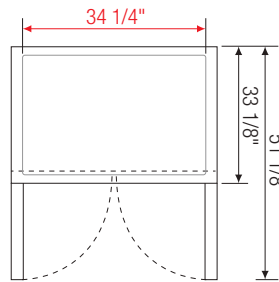

EBGR2

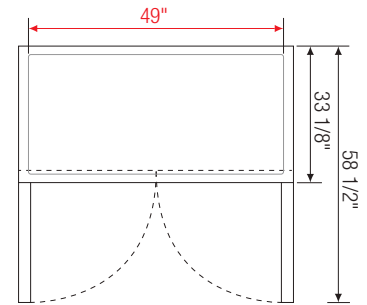

Model	Ref/ Frz/ Dual	# of Doors	Capacity (Cu. Ft.) [†]	HP	BTU/HR [†]	Refrigerant	# of Shelves	Power (V-Hz-Ph)	Amps	Crated Weight (LBS)	Exterior Dimensions (Inches)		
											L	D ^a	H [*]
EBGR1	Ref	1	21	1/3	2,311	R290	4	115-60-1	2.5	370	27	33 1/8	77
EBGNR2	Ref	2	33	1/3	2,311	R290	8	115-60-1	2.5	491	39 3/8	33 1/8	77
EBGR2	Ref	2	50	3/4	4,445	R290	8	115-60-1	6.5	596	54 1/8	33 1/8	77

* Height does not include 5" for casters.

† Based on evaporating temperature of 23°F (-5°C) & condensing temperature of 131°F (55°C).

^a Exterior depth dimension does not include 1-1/2" for door handles.

Ref = Refrigerator

Specifications subject to change without notice.

Product dimensions are for general purposes and not absolute value. Product capacity (†) is calculated based on standard industry figures. Slight variations may exist. If dimensions and capacity are critical, please contact Everest Refrigeration.