

Food Prep. Tables

BACK MOUNTED CONDENSING UNIT (EPB & EOTP SERIES)

Refrigerators



The Food Prep. Table (Back Mount) series doubles as a cold storage and working area for ingredients that need to be cut, sliced and prepared before use. It serves a variety of functions not only as a food prep and assembly station but also as a condiment/topping dispensary and buffet line.

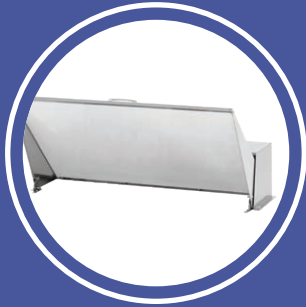

Insulated Top Lid
Closes for cold storage.
Props open when serving.



Adjustable Top Pans
Detachable dividers accommodate
varied top pan sizes.



Detachable Cutting Board
Removable for cleaning.
Extendable for extra prep space.



Blizzard R290
EPA/DOE approved, all-in-one,
slide-out cooling cartridge.

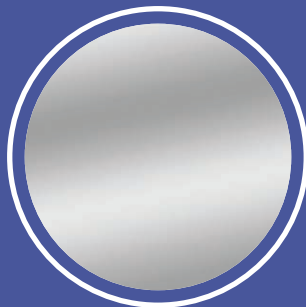

All Stainless Steel
High quality finish with 2.5"
thick thermal insulation.



Ridge-Lined Gasket
Heavy-duty door gaskets
snap out/in for easy cleaning.



Opt. Overshelf
Stainless steel double overshelf
for additional storage.

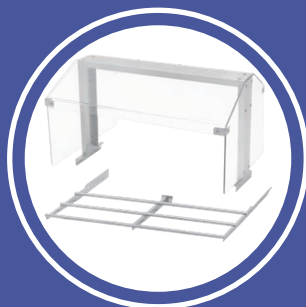

Opt. Sneeze Guard & Slides
Durable glass sneeze guards
and stainless steel tray slides.



More Features
Digital control, overheat alarm,
ECM motors, LED lights, etc.

Back Mount Sandwich Prep. Tables – EPBN Series

Back Mounted Condensing Unit



EPBNR1

EPBNSR2



EPBNSR2



EPBNWR2



EPBNR3

Cabinet Construction

- Heavy duty stainless steel interior / exterior with rounded corners for a hazard-free workspace.
- Open spaced interior with no walls between cabinet compartments.
- Vented stainless steel panel between top pan area and cabinet catches food debris.
- 16 gauge, high quality stainless steel worktop, lid and hood.
- Galvanized steel bottom and rear.
- 2.5" thick high density polyurethane insulation.
- Four 5" swivel casters with locks on front set.

Refrigeration System

- Back mounted, self-contained and fully detachable Blizzard R290 condensing unit uses environmentally friendly, EPA-compliant R290 refrigerant with zero (0) Ozone Depletion Potential (ODP) and three (3) Global Warming Potential (GWP). Blizzard R290 is easily replaceable and requires no on-site brazing.
- Front air breathing for flexibility in installation.
- Electronically commutated (ECM) fan motors achieve rapid cooling with less energy consumption.
- Full-length air duct ensures optimal cold air circulation.
- Time-initiated and temperature-terminated auto defrost cycle for seamless operation.
- Large capacity, corrosion-resistant condenser and evaporator coils.
- Self-maintaining, energy-efficient condensate drain pan requires no external drains or electric heaters.
- High performance, auto-reverse condenser fan motor supports compressor ventilation and condenser coil cleaning.
- Pressure relief devices allow rapid cabinet re-entry.
- Pre-wired and ready to plug, 115V/60Hz/1Ph, NEMA 5-15P.

Doors

- Heavy duty stainless steel interior / exterior.
- 2.5" thick high density polyurethane insulation.
- Frame heaters prevent exterior moisture build up.
- Self-closing with adjustable torsion system for a positive seal.
- Snap-in magnetic gasket for ease of cleaning.
- High strength, recessed handles.

Preparation Area

- NSF certified polycarbonate 6" deep pans (see table for quantity).
- 1/2" thick, foam insulated lid keeps top pan area cold and prevents moisture build-up.
- 12 1/4" deep cutting board is removable for ease of cleaning.

Shelving

- One epoxy coated, steel wire shelf per section.
- Height adjustable stainless steel clips.

Temperature Control

- Multi-function digital controller with easy to read LED display.
- Factory preset temperature, 35°F. Temp-set range from 33°F to 54°F.
- Audible overheat protection alarm for compressor and condenser coil.

Options

- NSF certified stainless steel double overshef.
- Additional shelving.
- 3" swivel casters with locks.
- 3.5" – 6" height-adjustable and interchangeable legs.
- Left hinged door (applies to EPBNR1).

↔ = Interior Dimensions ← → = Exterior Dimensions

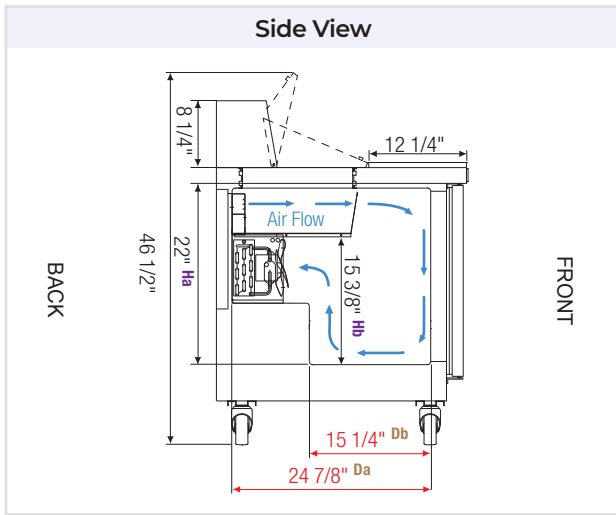

Equipped with 9 ft long NEMA 5-15P plug.

√ : Mounting space for overshef.

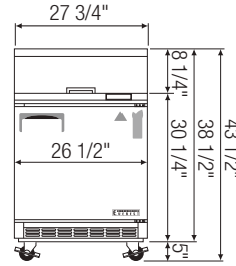
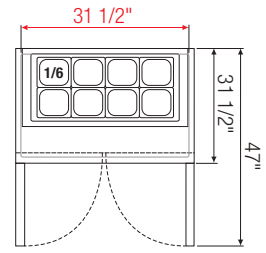
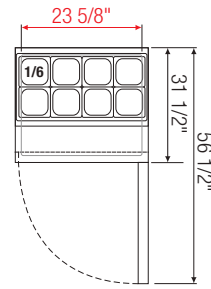

EPBNR1

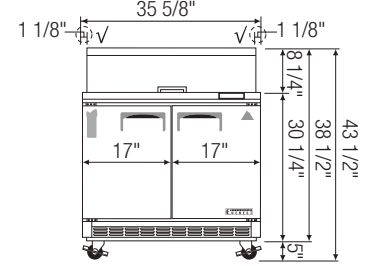

EPBNSR2

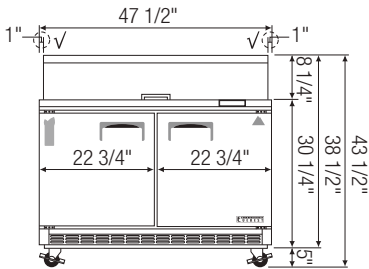
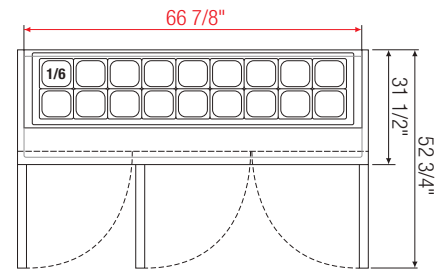
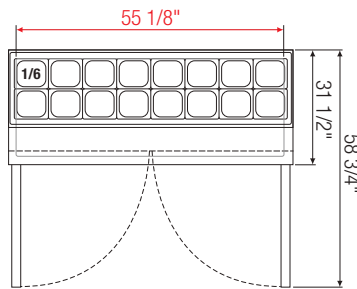
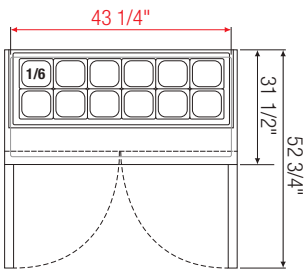

EPBNR2

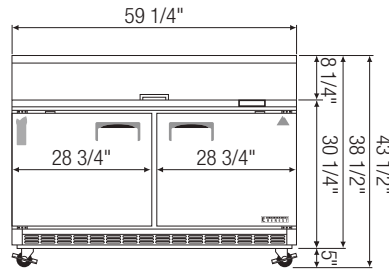

EPBNWR2

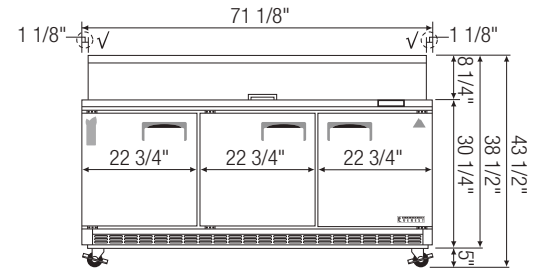

EPBNR3

Model	Ref/ Frz/ Dual	# of Doors	Capacity [†] (Cu. Ft.)	HP	Refrigerant	# of Shelves	# of Pans	Power (V-Hz-Ph)	Amps	Crated Weight (LBS)	Exterior Dimensions (Inches)		
											L	D ^a	H [*]
EPBNR1	Ref	1	8	1/5	R290	1	1/6 X 8	115-60-1	2.5	226	27 3/4	31 1/2	38 1/2
EPBNSR2	Ref	2	10	1/5	R290	2	1/6 X 8	115-60-1	2.5	268	35 5/8	31 1/2	38 1/2
EPBNR2	Ref	2	13	1/4+	R290	2	1/6 X 12	115-60-1	3.5	313	47 1/2	31 1/2	38 1/2
EPBNWR2	Ref	2	16	1/3	R290	2	1/6 X 16	115-60-1	2.5	382	59 1/8	31 1/2	38 1/2
EPBNR3	Ref	3	19	1/3	R290	3	1/6 X 18	115-60-1	3	426	71 1/8	31 1/2	38 1/2

* Height does not include 5" for casters.

^a Depth includes 12 1/4" cutting board.

Da, Db Interior Depth Ha, Hb Interior Height

Specifications subject to change without notice.

Product dimensions are for general purposes and not absolute value. Product capacity (†) is calculated based on standard industry figures. Slight variations may exist. If dimensions and capacity are critical, please contact Everest Refrigeration.

Ref = Refrigerator