



ALUMINUM
DUNNAGE RACKS

STATIONARY DUNNAGE RACKS



Item #: _____ Qty #: _____
 Model #: _____
 Project #: _____

12" HEIGHT

MODEL #	Width "W"	Length "L"	No. of Legs	Height "H"	Clearance "C"	Wt.
DUN-2036	20"	36"	4	12"	10 1/4"	10 lbs.
DUN-2048	20"	48"	4	12"	10 1/4"	12 lbs.
DUN-2060	20"	60"	6	12"	10 1/4"	16 lbs.
DUN-2436	24"	36"	4	12"	10 1/4"	11 lbs.
DUN-2448	24"	48"	4	12"	10 1/4"	13 lbs.
DUN-2460	24"	60"	6	12"	10 1/4"	17 lbs.

8" HEIGHT

MODEL #	Width "W"	Length "L"	No. of Legs	Height "H"	Clearance "C"	Wt.
DUN-2036-8	20"	36"	4	8"	6 1/4"	10 lbs.
DUN-2048-8	20"	48"	4	8"	6 1/4"	11 lbs.
DUN-2060-8	20"	60"	6	8"	6 1/4"	12 lbs.
DUN-2436-8	24"	36"	4	8"	6 1/4"	9 lbs.
DUN-2448-8	24"	48"	4	8"	6 1/4"	12 lbs.
DUN-2460-8	24"	60"	6	8"	6 1/4"	13 lbs.

FEATURES:

Heavy duty welded construction.
 1-3/4" square tubing.
 1500 lb. Load Capacity (Evenly distributed load).

CONSTRUCTION:

Fully welded 1-3/4" square aluminum tube assembly.
 Legs are 1-3/4" square tubing with Plastic Feet.

MATERIAL:

6063-T52 extruded aluminum tube.

MOBILE DUNNAGE RACKS

FEATURES:

Heavy duty welded construction.
 1-3/4" square tubing.
 6" Heavy Duty Casters.
 Includes Handle.
 2000 lb. Rolling Load Capacity (Evenly distributed load).

CONSTRUCTION:

Fully welded 1-3/4" square aluminum tube assembly.
 6" diameter casters bolted to Base of Mobile Dunnage Rack.
 Handle secures to rack with Locking Set Screws.

MATERIAL:

6063-T52 extruded aluminum tube.



Includes Handle!

MODEL #	Width	Length	Wt.
DUN-2036C	20"	36"	35 lbs.
DUN-2048C	20"	48"	40 lbs.
DUN-2060C	20"	60"	45 lbs.

Replacement	Model #	Wt.	Qty
Mobile Dunnage Rack Handle	DUNH-1	7 lbs.	



Customer Service Available To Assist You 1-800-645-3166 8:30 am - 8:00 pm E.S.T.

For Orders & Customer Service:
 Email: customer@advancetabco.com or Fax: 631-242-6900

For Smart Fabrication™ Quotes:
 Email: smartfab@advancetabco.com or Fax: 631-586-2933

DIMENSIONS and SPECIFICATIONS

TOL \pm .500"

ALL DIMENSIONS ARE TYPICAL

STATIONARY DUNNAGE RACKS

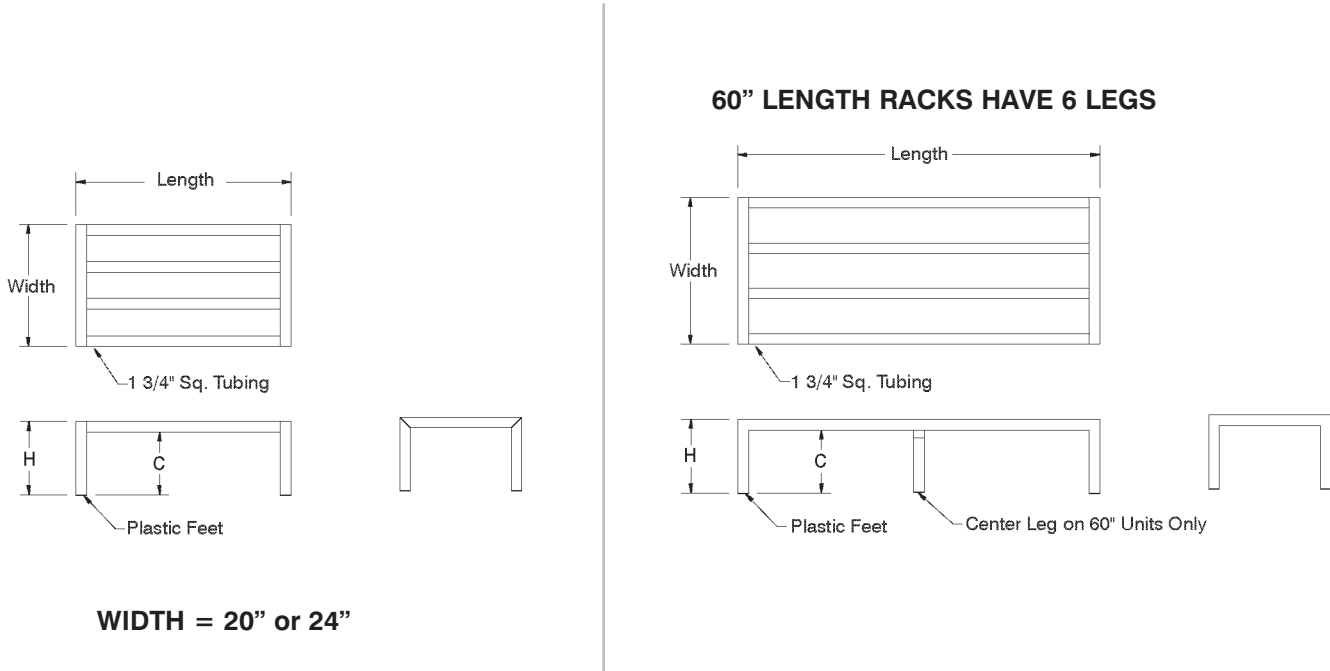

MOBILE DUNNAGE RACKS

