

# ITCB-DV, 29" Trunk, W/Tray

Height: 35.0" Width: 11.6" Depth: 22.1"  
(88.9cm) (29.5cm) (56.1cm)



- Sleek modernized design language, with rounded angles on the corners and trunk
- Digital readout displays in English, Spanish, or French ---for easier programming and control--- and can show either 'Standard' or Metric measurements. Digital readout also shows machine status, and targeted advertising messages can be programmed for display.
- BUNN Infusion Series technology allows for multiple recipes from one footprint --- with three brew buttons and two batch sizes
- Energy-saver mode reduces tank temperature during idle periods
- Exclusive Peak Extraction™ Sprayhead is multi-directional with a 17-hole design to ensure ultimate uniformity of extraction
- Electronic funnel lock prevents removal of each brew funnel until drip- through is complete
- USB programming capable
- Pre-infusion and pulse brew for maximum flavor extraction. Cold brew lockout & digital temperature control further ensure top-notch brewing.
- Brews into all BUNN iced tea dispensers (except TDS-5), 1.9 to 3.8 liter airpots, thermal carafes --- and can accommodate BUNN ThermoFresh® Servers [servers not included]
- Includes integrated flip tray that converts to three positions: thermal carafe, airpot and tea dispenser
- Dual voltage adaptable (Can operate at 120V/15 amp or 120/208-240V/20 amp)

 Server(s) sold separately

Agency:



## Specifications

**Product #:** 52200.0100

**Interface:** Wireless

**Finish:** Stainless

**Funnel:** Black Plastic

**Water Access:** Plumbed

## Additional Features

Funnel Locks

## Electrical & Capacity

Volts*	Amps	Watts	Cord Attached	Plug Type	8oz cups/hr 236ml cups/hr	Input H <sub>2</sub> O Temp.	Phase	# Wires plus Ground	Hertz
120	14	1700	Yes	NEMA 5-15P	80	60°F (15.5°C)	1	2	60
120/208	13	2650	-	N/A	123	60°F (15.5°C)	1	3	60
120/240	15	3500	-	N/A	163	60°F (15.5°C)	1	3	60

\*When a BUNN is machine rated 120/208-240V, 120/208V or 120/240V, the higher voltage is the supply voltage needed to power the machine. The 120V is there to supply power to some components rated 120V in the machine, but it is not the supply voltage and would not power the machine if the machine is marked with the before mentioned ratings.

## Plumbing Requirements

PSI	kPa	Fitting Supplied	Water Flow Required (GPM)
20-90	138-621	1/4" Male Flare Fitting	1.25

## CAD Drawings

2D	Revit	KLC
●		

 **WARNING:**



BUNN® reserves the right to change specifications and product design without notice. Such revisions do not entitle the buyer to corresponding changes, improvements, additions or replacements for previously purchased equipment. For most current specifications and other info visit [bunn.com](http://bunn.com).

Last Updated:  
03/18/2024

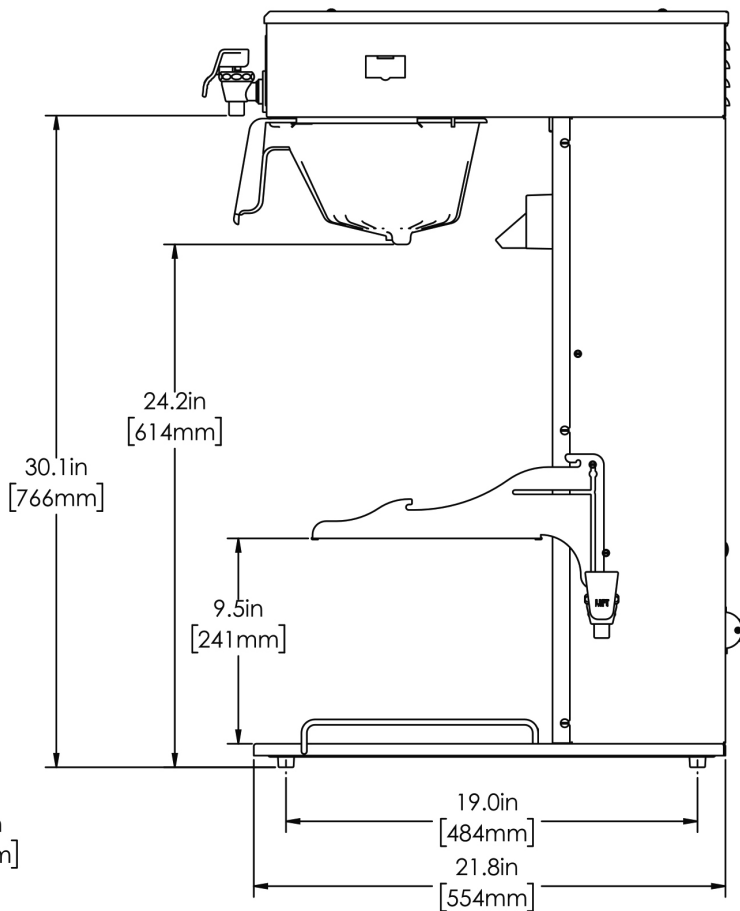
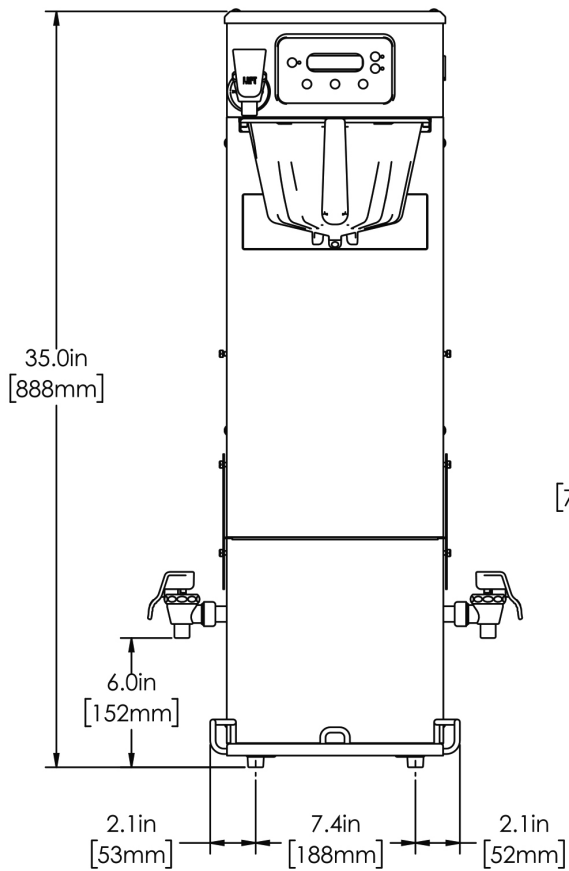
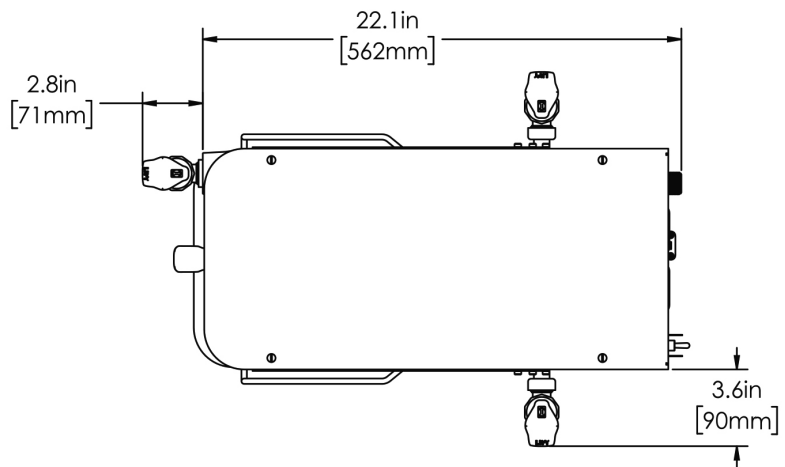

	Unit			Shipping				
	Height	Width	Depth	Height	Width	Depth	Weight	Volume
English	35.0 in.	11.6 in.	22.1 in.	39.0 in.	15.9 in.	27.5 in.	47.600 lbs	9.853 ft <sup>3</sup>
Metric	88.9 cm	29.5 cm	56.1 cm	99.1 cm	40.3 cm	69.9 cm	21.591 kgs	0.279 m <sup>3</sup>



BUNN® reserves the right to change specifications and product design without notice. Such revisions do not entitle the buyer to corresponding changes, improvements, additions or replacements for previously purchased equipment. For most current specifications and other info visit [bunn.com](http://bunn.com).

Last Updated:  
03/18/2024

# Related Products & Accessories:ITCB-DV, 29" Trunk, W/Tray(52200.0100)



FILTERS, GOURMET 500  
500/1 50/CL

Product #: 20138.1000

FUNNEL ASSY, SMART  
COFFEE BLK-CLEARED

Product #: 53463.0038

FUNNEL ASSY, TEA  
NATURAL QUICK BREW

Product #: 53463.0039



STAND ASSY KIT, TF  
SERVER

Product #: 54473.1000



SYSTEM, WQ-55(2)5

Product #: 56000.0004



SYSTEM, WQ-SFTN4000  
(1.5)10 TEA

Product #: 56000.0021



SYSTEM, WEQ-10(1.5)5L

Product #: 56000.0024



SYSTEM, WEQ-10(1.5)5

Product #: 56000.0027



SYSTEM, WEQ-  
SFTN3500(1)10 TEA

Product #: 56000.0030



CARTRIDGE, WQ-55(2)5

Product #: 56000.0104



CARTRIDGE, WEQ-10  
(1.5)5L

Product #: 56000.0121



CARTRIDGE, WEQ-10  
(1.5)5

Product #: 56000.0122



CARTRIDGE, WEQ-  
SFTN3500(1)10 TEA

Product #: 56000.0129



CARTRIDGE, WQ-  
SFTN4000(1.5)10 TEA

Product #: 56000.0133



BUNN® reserves the right to change specifications and product design without notice. Such revisions do not entitle the buyer to corresponding changes, improvements, additions or replacements for previously purchased equipment. For most current specifications and other info visit [bunn.com](http://bunn.com).

Last Updated:  
03/18/2024

# Serving & Holding Options: ITCB-DV, 29" Trunk, W/Tray(52200.0100)



AIRPOT, 2.5L GL PB  
SINGLE PK

Product #:13041.0001



AIRPOT, 2.5L SST LA  
SINGLE PK

Product #:32125.0000



AIRPOT, 3.0L SST LA  
SINGLE PK

Product #:32130.0000



TDS-3, 3 GAL

Product #:33000.0000



TDS-3.5, 3.5 GAL

Product #:33000.0023



TDO-4, RESERVOIR

Product #:34100.0000



TDO-5, RESERVOIR

Product #:34100.0001



TDO-4, RESERVOIR  
BREW THRU

Product #:34100.0002



TDO-5, RESERVOIR,  
BREW THRU

Product #:34100.0003



THERMAL CARAFE, BLK  
1.83 L 1PK

Product #:36029.0001



THERMAL CARAFE,ORN  
1.9L 1PK

Product #:36252.0001



TDO-N-3.5, RSVR

Product #:39600.0001



TDO-N-3.5, RSVR W/  
LIFT HANDLE

Product #:39600.0031



TDO-N-3.5, RSVR W/  
PINCH TUBE

Product #:39600.0047



CARAFE,SST 1.9L SHRT  
BLK 1

Product #:40163.0000



TF SERVER, 1G DSG  
GEN3 NOBASE

Product #:42700.0250



TF SERVER, 1G MECH  
GEN3 NOBASE

Product #:44000.0250



BUNN® reserves the right to change specifications and product design without notice. Such revisions do not entitle the buyer to corresponding changes, improvements, additions or replacements for previously purchased equipment. For most current specifications and other info visit [bunn.com](http://bunn.com).

Last Updated:  
03/18/2024