



VC44E SERIES

Double Deck Electric Convection Ovens



Model VC44ED
Shown on optional casters



SPECIFIER STATEMENT

Double section, electric convection oven, Vulcan Model No. (VC44ED) (VC44EC). Stainless steel front, sides, top and legs. Independently operated stainless steel doors with double pane windows. Non-sag insulation applied to the top, rear, sides, bottom and doors. Porcelain enamel on steel oven interiors measure 29" w x 22 $\frac{1}{8}$ " d x 20" h. Two interior oven lights per section. Five nickel plated oven racks per section measure 28 $\frac{3}{4}$ " x 20 $\frac{1}{2}$ ". Eleven position nickel plated rack guides with positive rack stops per section. Each section heated by electric solid sheath elements rated at 12 KW. Furnished with a two speed $\frac{1}{2}$ H.P. oven blower-motor per section. Oven cool switch for rapid cool down. 208 or 240 volt, 60 Hz, 1 or 3 phase.

Exterior Dimensions:

40 $\frac{1}{4}$ " W x 41 $\frac{1}{8}$ " D (includes motor & door handles)

40 $\frac{1}{4}$ " W x 37 $\frac{3}{4}$ " D (includes motor only)

70" H on 8" legs.

NSF listed. UL listed. UL listed to Canadian safety standards.

Project _____

AIA # _____ SIS # _____

Item # _____ Quantity _____ C.S.I. Section 114000

MODELS

- VC44ED** Solid state temperature controls adjust from 150° to 500°F. 60 minute timer with audible alarm.
- VC44EC** Computer controls with digital time and temperature readouts. 99-hour timer with audible alarm. Roast and Hold cycle. One hundred programmable menu selections. Shelf I.D. programming.

STANDARD FEATURES

- Stainless steel front, sides, top and legs
- Independently operated stainless steel doors with double pane windows
- 25 total KW
- $\frac{1}{2}$ H.P. two speed oven blower-motor
- Moisture vent
- Oven cool switch for rapid cool down
- Porcelain enamel on steel oven interiors
- Five nickel plated grab-and-go oven racks with eleven rack positions per section (10 total racks)
- One year limited parts and labor warranty

OPTIONS

- Complete prison package
 - Security screws only
- Casters
- Simultaneous chain driven doors
- 480V/60 Hz/1 or 3 phase
- Second year extended limited parts and labor warranty

ACCESSORIES (PACKAGED AND SOLD SEPARATELY)

- Stainless steel rear motor enclosure
- Extra oven rack(s)
- Rack hanger(s)
- Stainless steel drip pan
- Down draft flue diverter for direct vent connection

VC44E SERIES – Double Deck Electric Convection Ovens

Approved by _____ Date _____ Approved by _____ Date _____

OPTIONAL VOLTAGES

- 480 volt, 60 Hz, 3 phase
- 220/380 volt, 50 Hz, 1 phase, 3 wire
- 220/380 volt, 50 Hz, 3 phase, 4 wire
- 240/415 volt, 50 Hz, 3 phase, 4 wire

CLEARANCES

	Combustible	Non-Combustible
Rear	2"	2"
Right Side	4"	4"
Left Side	1"	1"

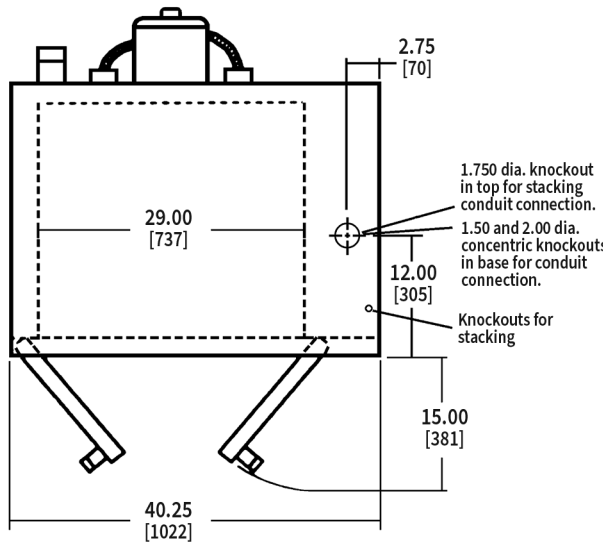

[CAD and/or Revit Files Available](#)

[INSTALLATION MANUAL](#)

40 $\frac{1}{4}$ " W x 41 $\frac{1}{8}$ " D (includes motor & door handles)
40 $\frac{1}{4}$ " W x 37 $\frac{3}{4}$ " D (includes motor only)
70" H on 8" legs

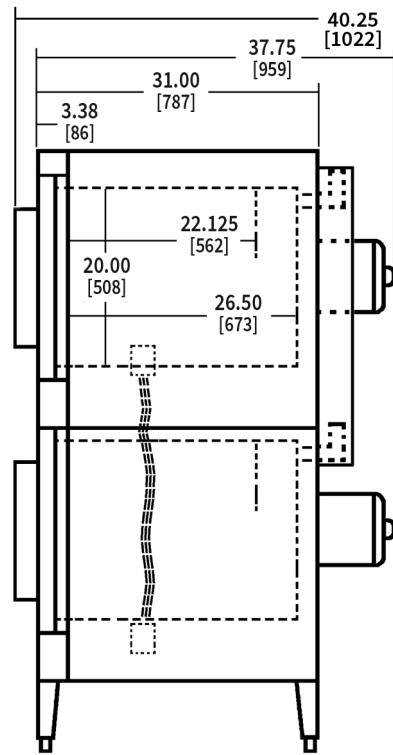
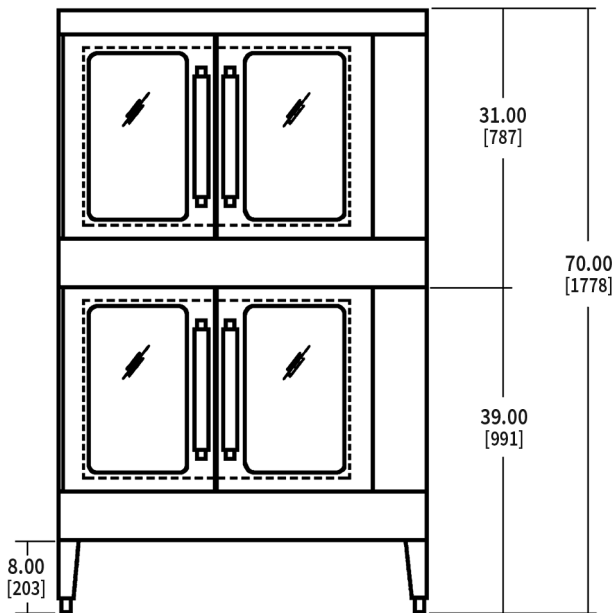

Nominal Amps per Line Wire

Model	Total Conn.	3 Phase Load KW per Phase		1 Phase		3 Phase									Weight	
		X-Y	Y-Z	X-Z	208 Volt		240 Volt			480 Volt						
					208V	240V	X	Y	Z	X	Y	Z	X	Y		Z
VC44E	25 kW	8	8	9	120	104	70	66	70	66	58	66	28	30	30	778 lbs (352 KG) without skids/packaging 880 lbs (400 KG) with skids/packaging

As continued product improvement is a policy of Vulcan, specifications are subject to change without notice.