



VC4E SERIES

Single Deck Electric Convection Ovens



Model VC4ED
Shown on optional casters



SPECIFIER STATEMENT

Single section, electric convection oven, Vulcan Model No. (VC4ED) (VC4EC). Stainless steel front, sides and top. Painted legs. Independently operated stainless steel doors with double pane windows. Non-sag insulation applied to the top, rear, sides, bottom and doors. Porcelain enamel on steel oven interior measures 29" w x 22 1/8" d x 20" h. Two interior oven lights. Five nickel plated oven racks measure 28 1/4" x 20 1/2". Eleven position nickel plated rack guides with positive rack stops. Heated by electric solid sheath elements rated at 12 KW. Furnished with a two speed 1/2 H.P. oven blower-motor. Oven cool switch for rapid cool down. 208 or 240 volt, 60 Hz, 1 or 3 phase.

Exterior Dimensions:

40 1/4" W x 41 1/8" D (includes motor & door handles)

40 1/4" W x 37 3/4" D (includes motor only)

54 3/4" H on 23 3/4" legs* with feet.

*Legs can adjust an additional 1" in length.

Legs with casters are adjustable from 28" to 29 1/2" in length.

NSF listed. UL listed. UL listed to Canadian safety standards.

Project _____

AIA # _____ SIS # _____

Item # _____ Quantity _____ C.S.I. Section 114000

MODELS

- VC4ED** Solid state temperature controls adjust from 150° to 500°F. 60 minute timer with audible alarm.
- VC4EC** Computer controls with digital time and temperature readouts. 99-hour timer with audible alarm. Roast and Hold cycle. One hundred programmable menu selections. Shelf I.D. programming.

STANDARD FEATURES

- Stainless steel front, sides and top
- Painted legs
- Independently operated stainless steel doors with double pane windows
- 12.5 total KW
- 1/2 H.P. two speed oven blower-motor
- Moisture vent
- Oven cool switch for rapid cool down
- Porcelain enamel on steel oven interior
- Five nickel plated grab-and-go oven racks with eleven rack positions
- One year limited parts and labor warranty

OPTIONS

- Complete prison package
 - Security screws only
- Stainless steel legs
- Casters
- Simultaneous chain driven doors
- 480V/60 Hz/1 or 3 phase
- Second year extended limited parts and labor warranty

ACCESSORIES (PACKAGED AND SOLD SEPARATELY)

- Stainless steel rear motor enclosure
- Extra oven rack(s)
- Rack hanger(s)
- Stainless steel drip pan
- Stainless steel open stand with adjustable rack supports, stainless steel shelf and choice of adjustable feet or casters
- Oven/steamer accessory kit; includes stainless steel marine edge top; requires 8" legs in lieu of standard legs
- Down draft flue diverter for direct vent connection

VC4E SERIES – Single Deck Electric Convection Ovens

Approved by _____ Date _____ Approved by _____ Date _____

OPTIONAL VOLTAGES

- 480 volt, 60 Hz, 3 phase
- 220/380 volt, 50 Hz, 1 phase, 3 wire
- 220/380 volt, 50 Hz, 3 phase, 4 wire
- 240/415 volt, 50 Hz, 3 phase, 4 wire

CLEARANCES

	Combustible	Non-Combustible
Rear	2"	2"
Right Side	4"	4"
Left Side	1"	1"

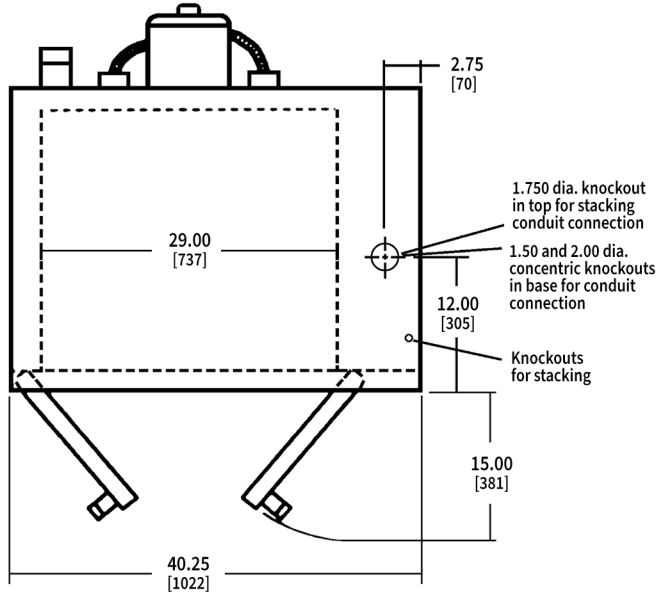

CAD and/or Revit Files Available

INSTALLATION MANUAL

40 $\frac{1}{4}$ " W x 41 $\frac{1}{8}$ " D (includes motor & door handles)
 40 $\frac{1}{4}$ " W x 37 $\frac{3}{4}$ " D (includes motor only)
 54 $\frac{3}{4}$ " H on 23 $\frac{3}{4}$ " legs* with feet.
 *Legs can adjust an additional 1" in length.

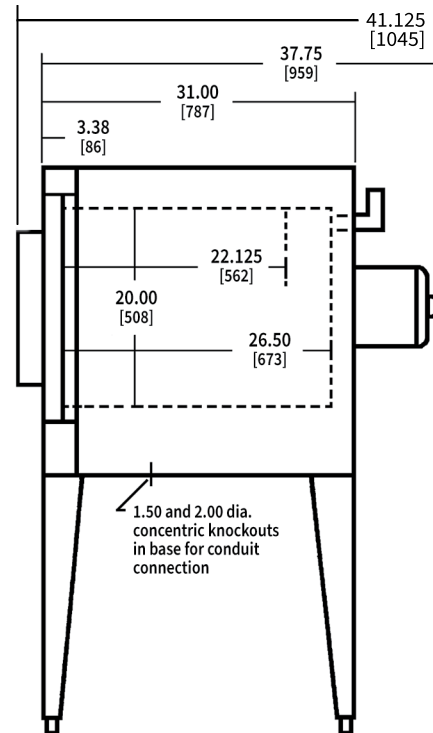
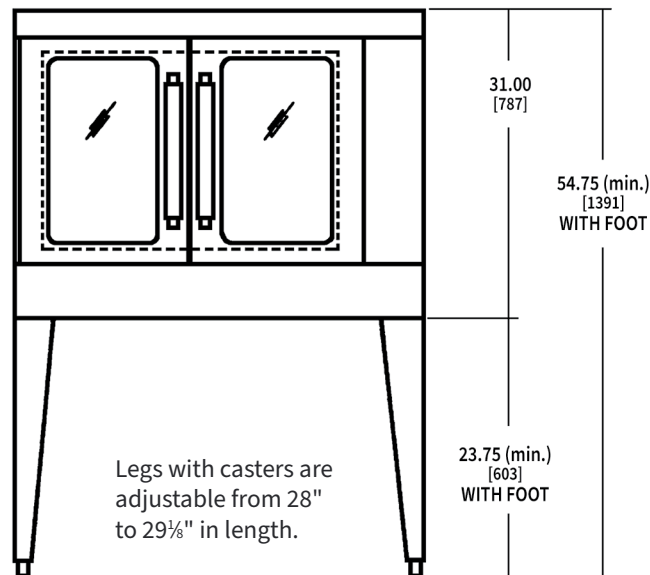

Nominal Amps per Line Wire

Model	Total Conn.	3 Phase Load KW per Phase		1 Phase		3 Phase									Weight	
		X-Y	Y-Z	X-Z	208 Volt		240 Volt			480 Volt						
					208V	240V	X	Y	Z	X	Y	Z	X	Y		Z
VC4E	12.5 kW	4	4	4.5	60	52	35	33	35	33	29	33	14	15	15	389 lbs (176 KG) without skids/packaging 440 lbs (200 KG) with skids/packaging

As continued product improvement is a policy of Vulcan, specifications are subject to change without notice.