



## V SERIES HDR GAS RANGES

### TOPS

Open Top

Hot Top

Griddle Top

Work Surface

### BASES

Standard Oven

Convection

Oven

Cabinet Base

### - NOTICE -

This Manual is prepared for the use of trained Hobart Service Technicians and should not be used by those not properly qualified.

This manual is not intended to be all encompassing. If you have not attended a Hobart Service School for this product, you should read, in its entirety, the repair procedure you wish to perform to determine if you have the necessary tools, instruments and skills required to perform the procedure. Procedures for which you do not have the necessary tools, instruments and skills should be performed by a trained Hobart Service Technician.

The reproduction, transfer, sale or other use of this manual, without the express written consent of Hobart, is prohibited.

This manual has been provided to you by ITW Food Equipment Group LLC ("ITW FEG") without charge and remains the property of ITW FEG, and by accepting this manual you agree that you will return it to ITW FEG promptly upon its request for such return at any time in the future.

# TABLE OF CONTENTS

SERVICE UPDATES .....	4
SERVICE UPDATES .....	4
TIS DOCUMENT LIST - V SERIES HDR GAS RANGES .....	4
GENERAL .....	6
INTRODUCTION .....	6
INSTALLATION, OPERATION AND CLEANING .....	6
TOOLS .....	6
SPECIFICATIONS .....	6
REMOVAL AND REPLACEMENT OF PARTS .....	8
PILOT SAFETY VALVE AND TEMPERATURE CONTROL ASSEMBLY (S MODEL) .....	8
MANIFOLD COVER .....	10
BULL NOSE .....	11
KICK PANEL .....	12
OVEN CAVITY BOTTOM PANEL (S MODEL) .....	12
OVEN CONTROL PANEL COVER .....	13
PILOT SAFETY VALVE (S MODEL) .....	15
SOLENOID, PILOT SAFETY AND GAS SHUT-OFF VALVE ASSEMBLY (C MODEL) .....	16
PILOT SAFETY VALVE (C MODEL) .....	18
TEMPERATURE CONTROL (THERMOSTAT) (S MODEL) .....	19
TEMPERATURE CONTROL (THERMOSTAT) C MODEL) .....	20
SOLENOID (C MODEL) .....	23
MANUAL GAS SHUT-OFF VALVE (C MODEL) .....	23
OVEN PILOT ASSEMBLY (C MODEL) .....	24
OVEN PILOT ASSEMBLY (S MODELS) .....	25
OVEN BURNER ASSEMBLY .....	26
PILOT QUICK DISCONNECT VALVE .....	28
TOP SECTION BURNER (OPEN TOP) .....	29
TOP SECTION BURNER (CHAR BROILER) .....	31
CHARBROILER PILOT .....	33
TOP SECTION BURNER (FRENCH/HOT TOP) .....	34
TOP SECTION BURNER CONTROL VALVE .....	35
CONVECTION MOTOR FAN CONTROL SWITCH (C MODEL) .....	35
CONVECTION MOTOR (C MODEL) .....	36
OVEN DOOR .....	37
OVEN DOOR COUNTER WEIGHT AND BEARING BLOCK .....	38
OVEN DOOR MICROSWITCH (C MODEL) .....	40
GRIDDLE THERMOSTAT-COMBO VALVE .....	41
GRIDDLE PILOT ASSEMBLY .....	43
GRIDDLE BURNER ORIFICE .....	43
SERVICE PROCEDURES AND ADJUSTMENTS .....	45
GAS LEAK CHECK .....	45
GAS PRESSURE CHECK .....	45
GAS PRESSURE REGULATOR ADJUSTMENT (OPTIONAL) .....	45
OVEN PILOT FLAME CHECK AND ADJUSTMENT .....	46
TOP BURNER PILOT .....	46
OVEN BURNER NOZZLE AND GAS ORIFICE CHECK .....	47
AIR SHUTTER ADJUSTMENT .....	47
TOP BURNER ADJUSTMENT .....	47
OVEN BURNER ADJUSTMENT .....	48
OVEN DOOR MICROSWITCH TEST (C MODEL) .....	48
FAN CONTROL SWITCH (C MODEL) .....	49
SOLENOID TEST (C MODEL) .....	49
BURNER AIR SHUTTER ADJUSTMENT .....	50
CHARBROILER PILOT ADJUSTMENT .....	51

GRIDDLE THERMOSTAT-COMBO VALVE CALIBRATION .....	51
OPERATION .....	51
CALIBRATION .....	51
BY-PASS FLAME ADJUSTMENT .....	52
TEMPERATURE CONTROL CALIBRATION .....	53
THERMOCOUPLE TEST .....	54
OPERATION .....	54
PILOT CHECKS .....	54
THERMOCOUPLE CHECKS .....	54
ELECTRICAL OPERATION .....	56
COMPONENT FUNCTION .....	56
SEQUENCE OF OPERATION (C MODEL) .....	56
WIRING DIAGRAM .....	58
TROUBLESHOOTING .....	59
TROUBLESHOOTING CHART .....	59

# SERVICE UPDATES

## SERVICE UPDATES

**March 2024**

- Added THERMOCOUPLE TEST.

**February, 2019**

- Service Manual moved into TIS from Multimedia at Rev 2 (12/09). Photos added to service manual. Up to revision C.

## TIS DOCUMENT LIST - V SERIES HDR GAS RANGES

SERVICE TAB	
Document Title	Document Type
V SERIES HDR GAS RANGES Service Manual	Service Manual

SERVICE TAB (Multimedia)	
Document Title	Document Type
Thermostat Capillary	Instructions
Wolf Heavy Duty Gas Operated Taco Range Instruction Manual	Instructions
FD-0 Field Information Bulletin	Misc
Repair Flood-Damaged Equipment	Misc
V Series Gas Ranges Operator	Operator
SB 1028 V Series Heavy Duty Ranges Griddle Bulb Placement	Service
SB 1039 Baso Safety Change	Service
Fundamentals of Gas	Service Instructions
HDR Top Section Removal & Installation Instructions	Service Instructions
Pilot and Burner Problems on Units Without Powered Burners Service Information	Service Instructions
SB1040 Pilot Change	Service Instructions
Vulcan Ranges (Gas) Service Information	Service Instructions
Rating Plate Locations on Current Vulcan-Hart/Wolf Range Equipment	Technical Service Bulletin (TSB)
SB 1027 V Series HD Ranges Oven Pilot Baffle Installation	Technical Service Bulletin (TSB)
TSB 0842 4 Position/3 Heat Switch - Ranges, Ovens, Broilers	Technical Service Bulletin (TSB)
TSB 1037A Hobart to Vulcan "Common" Model Cross Reference List	Technical Service Bulletin (TSB)
TSB 1240 HOBART AND VULCAN GAS RANGES - SAFETY SHUTOFF VALVE CHANGE	Technical Service Bulletin (TSB)
TSB 1311 Hobart & Vulcan Medium Gas Ranges with Electronic Ignition - Enhanced Ignition Modules	Technical Service Bulletin (TSB)
TSB 1328A Hobart & Vulcan Medium Gas Ranges - BASO Safety Shutoff Valve Changes	Technical Service Bulletin (TSB)

<b>SERVICE TAB (Multimedia)</b>	
RobertShaw FS Flane Switch Recall Vulcan & Wolf Equipment Effected - PN 713933	Technical Service Bulletin (TSB)

<b>PARTS TAB</b>	
<b>Document Title</b>	<b>Document Type</b>
V Series HDR Gas Ranges Parts Catalog	Parts Catalog

# GENERAL

## INTRODUCTION

Procedures in this manual will apply to all models unless specified. Pictures and illustrations can be of any model unless the picture or illustration needs to be model-specific. Before performing maintenance on the equipment, thoroughly read this manual and carefully follow the instructions in the order given.

## INSTALLATION, OPERATION AND CLEANING

For detailed installation, operation and cleaning instructions, refer to Installation and Operation Manual available online at [www.vulcanequipment.com](http://www.vulcanequipment.com).

## TOOLS

### Standard

- Standard set of hand tools.
- VOM with minimum of NFPA-70E CATIII 600V, UL/CSA/TUV listed. Sensitivity of at least 20,000 ohms per volt and the ability to measure DC micro amps. Meter leads must also be rated at CAT III 600V.
- Clamp on type amp meter with minimum of NFPA-70E CAT III 600V,UL/CSA/TUV listed.
- Temperature tester (thermocouple type).
- ESD (Electrostatic discharge) Protection Kit.

### Special

- Hazardous gas leak tester.
- Manometer.
- Thermocouple Adaptor (Closed circuit DC voltages (purchased locally) Adaptors vary between manufacturers.

## SPECIFICATIONS

ELECTRICAL			
Models	Voltage	Amps	Frequency
Convection Models	120/60/1 OR 208/60/1 (Optional)	15	50/60

<b>GAS LINE PRESSURES</b>		
<b>Pressure</b>	<b>Natural (in W.C.)</b>	<b>Propane (in W.C.)</b>
Inlet Supply	7.0 min.	11.0 min.
Operating	6.0 min.	10.0 min.

# REMOVAL AND REPLACEMENT OF PARTS

## PILOT SAFETY VALVE AND TEMPERATURE CONTROL ASSEMBLY (S MODEL)



**⚠ WARNING**

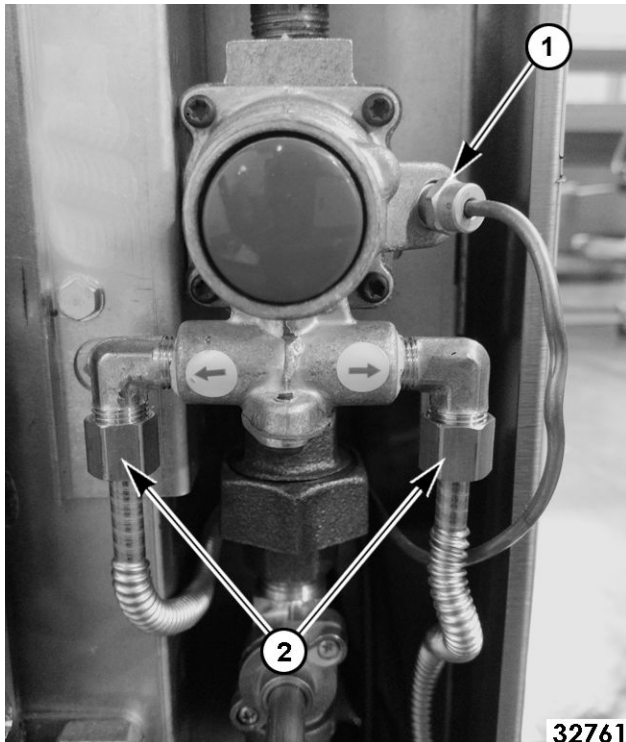
Disconnect the electrical power to the machine and follow lockout / tagout procedures.



**⚠ WARNING**

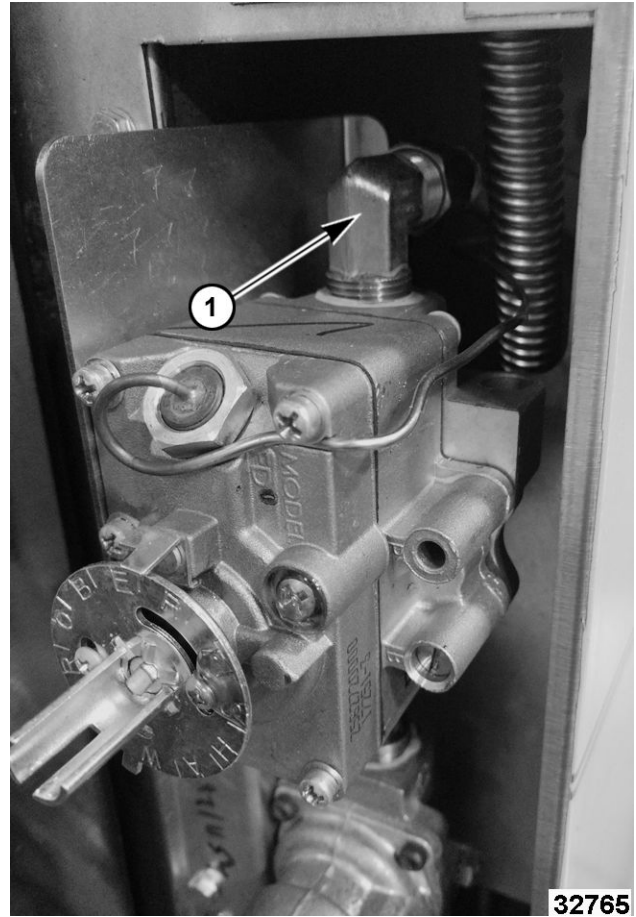
Shut off the gas before servicing the unit and follow lockout / tagout procedures.

1. Disconnect supply power and gas.
2. Remove OVEN CONTROL PANEL COVER.
3. Remove thermocouple (1, Fig. 1).



**Fig. 1**

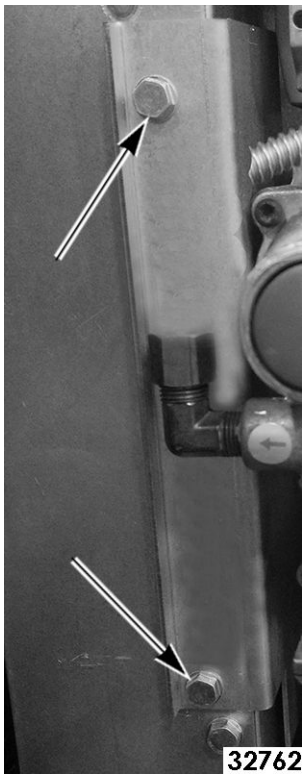
4. Disconnect flex lines (2, Fig. 1) from pilot safety valve.
5. Disconnect flex line (1, Fig. 2) from top of temperature control.



**Fig. 2**

6. Remove screws (Fig. 3) securing gas mount bracket to oven.



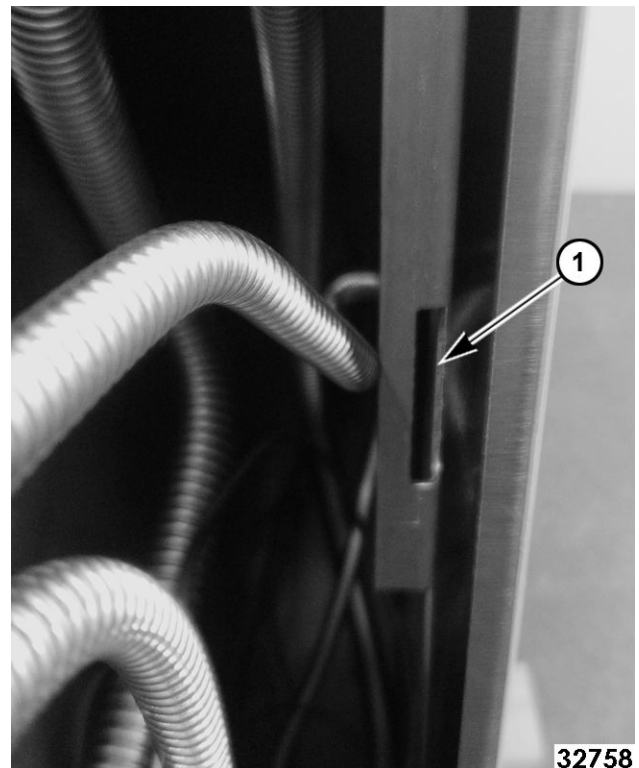


**Fig. 3**



**Fig. 4**

7. Lift up gas mount bracket to release hook (1, Fig. 4) off inner tab (1, Fig. 5). Pull out pilot safety valve and temperature control bracket assembly from oven.



**Fig. 5**

**⚠ WARNING**

Clean pipe threads and apply thread sealant that is suitable for use with propane gases.

**⚠ WARNING**

All gas joints disturbed during servicing must be checked for leaks. Check with a soap and water solution (bubbles). Do not use an open flame.

8. Reverse procedure to install.
9. Verify proper oven operation.

**MANIFOLD COVER**



**⚠ WARNING**

Disconnect the electrical power to the machine and follow lockout / tagout procedures.



**⚠ WARNING**

Shut off the gas before servicing the unit and follow lockout / tagout procedures.

1. Disconnect supply power and gas.
2. Loosen setscrews (1, Fig. 6) in burner control knobs and remove knobs.

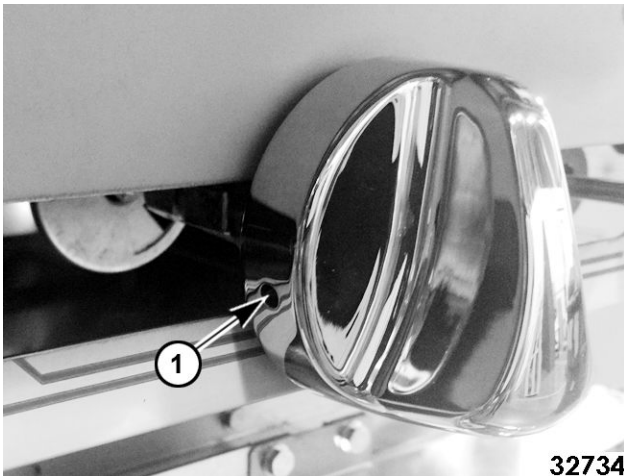


Fig. 6

3. Remove drive screws (1, Fig. 7) on both sides securing manifold cover in place and remove cover.

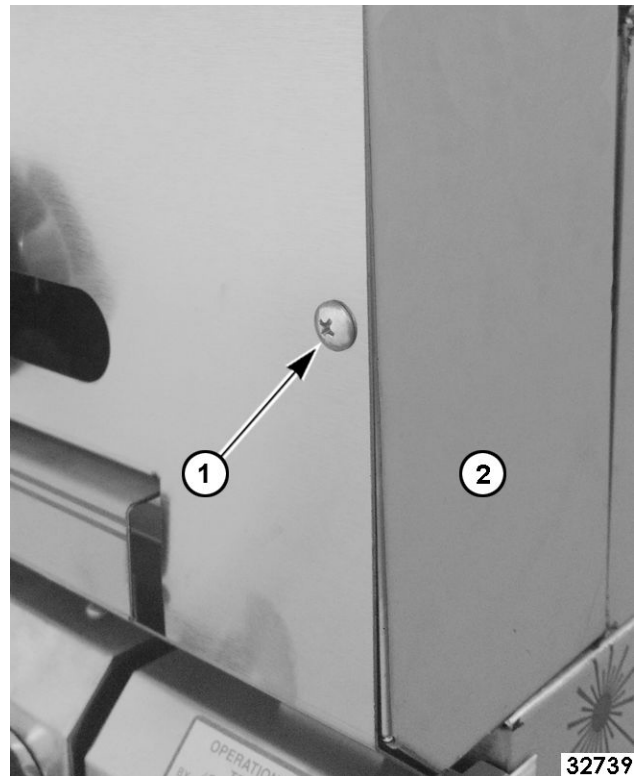


Fig. 7

4. Remove end caps (2, Fig. 7), if applicable.
5. Remove both front ledge support screws on angled brackets.

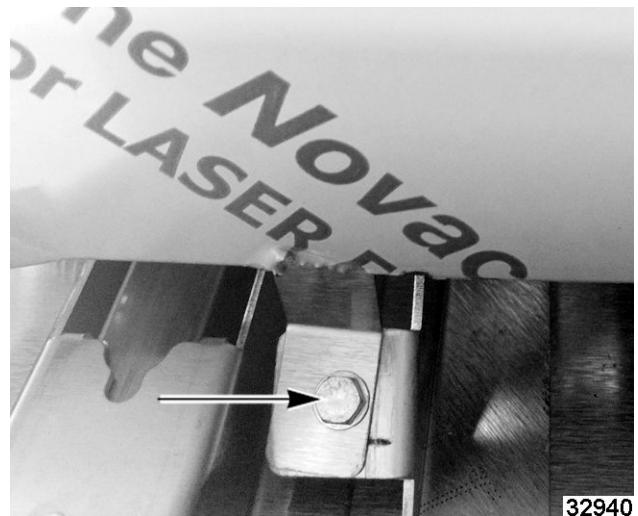


Fig. 8

6. Remove screws along bottom under crumb tray.

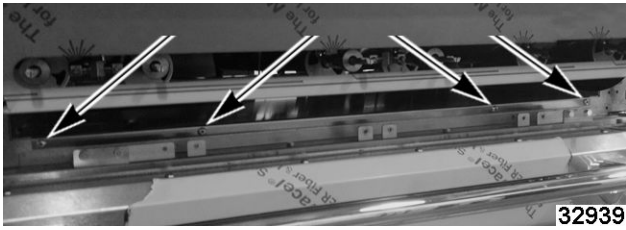


Fig. 9

- Reverse procedure to install.

## BULL NOSE



### ⚠ WARNING

Disconnect the electrical power to the machine and follow lockout / tagout procedures.



### ⚠ WARNING

Shut off the gas before servicing the unit and follow lockout / tagout procedures.

- Turn top burners and griddle off.
- Remove front row of top burner grates on ranges with open top burners.
- Remove all screws securing bull nose to range.



Fig. 10

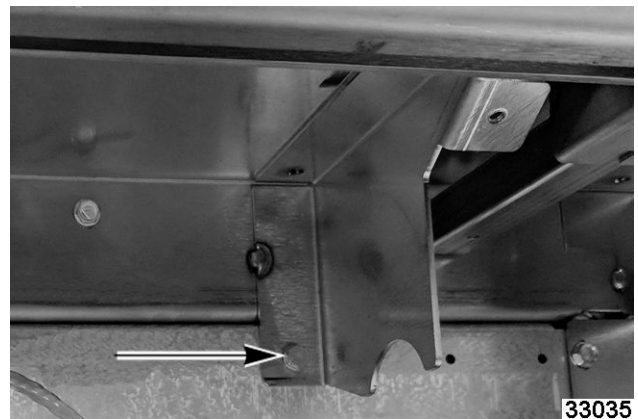


Fig. 11

**NOTE:** Fig. 11 Each side.

- Lift bull nose off range.
- Reverse procedure to install.

## KICK PANEL



### ⚠ WARNING

Disconnect the electrical power to the machine and follow lockout / tagout procedures.



### ⚠ WARNING

Shut off the gas before servicing the unit and follow lockout / tagout procedures.

1. Disconnect supply power and gas.
2. Lift up and tilt kick panel forward to open.



Fig. 12

3. Remove bottom screw and loosen screw on top, on one side.

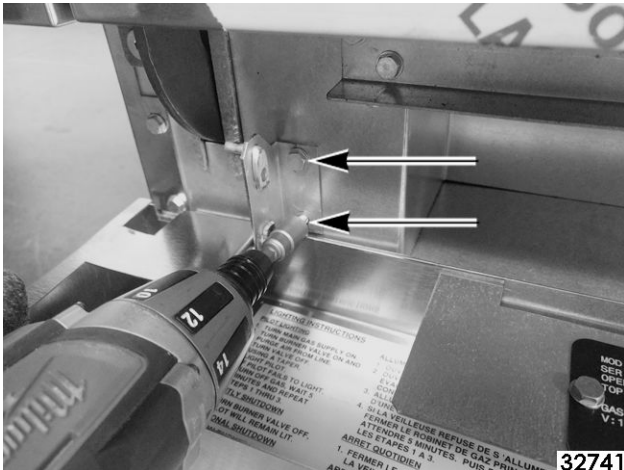


Fig. 13

4. Slide kick panel to other side to disengage pin from hinge to remove kick panel from range.



Fig. 14

5. Reverse procedure to install.

## OVEN CAVITY BOTTOM PANEL (S MODEL)



### ⚠ WARNING

Disconnect the electrical power to the machine and follow lockout / tagout procedures.



### ⚠ WARNING

Shut off the gas before servicing the unit and follow lockout / tagout procedures.

1. Disconnect supply power and gas.
2. Open oven door.
3. Remove racks (1, Fig. 15).

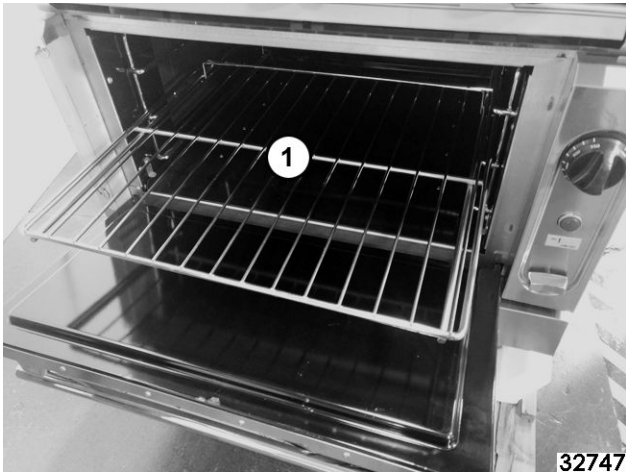


Fig. 15

4. Lift and pull out rack guides (1, Fig. 16).



Fig. 16

5. Slide retaining latches around so they rest against setscrew.

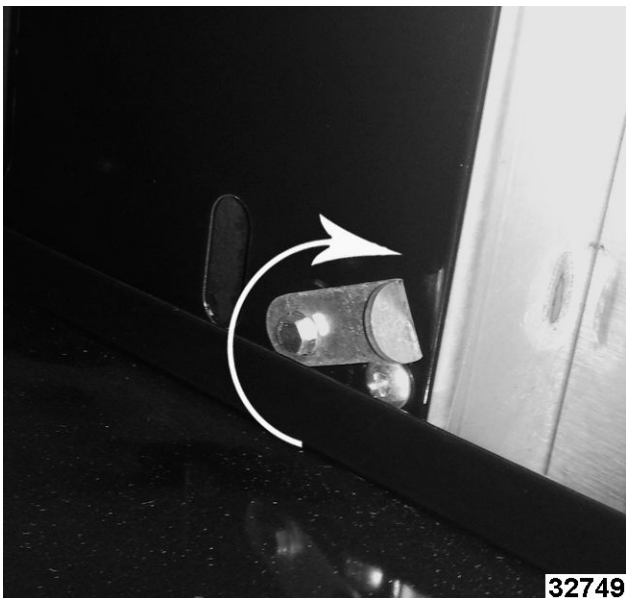


Fig. 17

6. Lift bottom panel up slightly and pull forward to remove.
7. Reverse procedure to install.
8. Verify proper oven operation.

## OVEN CONTROL PANEL COVER



### ⚠ WARNING

Disconnect the electrical power to the machine and follow lockout / tagout procedures.



### ⚠ WARNING

Shut off the gas before servicing the unit and follow lockout / tagout procedures.

1. Disconnect supply power and gas.
2. Open kick panel.
3. Loosen setscrews (5/32 allen wrench) from gas shut-off knob (1, STANDARD MODEL, CONVECTION MODEL) and temperature control knob (2, STANDARD CONVECTION) and remove.



Fig. 18



Fig. 19

4. Remove control panel mounting screw (1, [Fig. 20](#)).



Fig. 20

- Remove control panel by lifting up bottom and releasing from tab (1, Fig. 21) on top of panel.

**NOTICE**

**CONVECTION MODELS:** Carefully remove cover, wiring connections exist between back of panel and control panel bracket.



Fig. 21

- Reverse procedure to install.
- Verify proper oven operation.

**PILOT SAFETY VALVE (S MODEL)**



**WARNING**

Disconnect the electrical power to the machine and follow lockout / tagout procedures.



**WARNING**

Shut off the gas before servicing the unit and follow lockout / tagout procedures.

- Disconnect supply power and gas.
- Remove PILOT SAFETY VALVE AND TEMPERATURE CONTROL ASSEMBLY (S MODEL).
- Remove union fitting (1, Fig. 22) and pipe fitting (2, Fig. 22) from top and bottom of pilot safety valve.



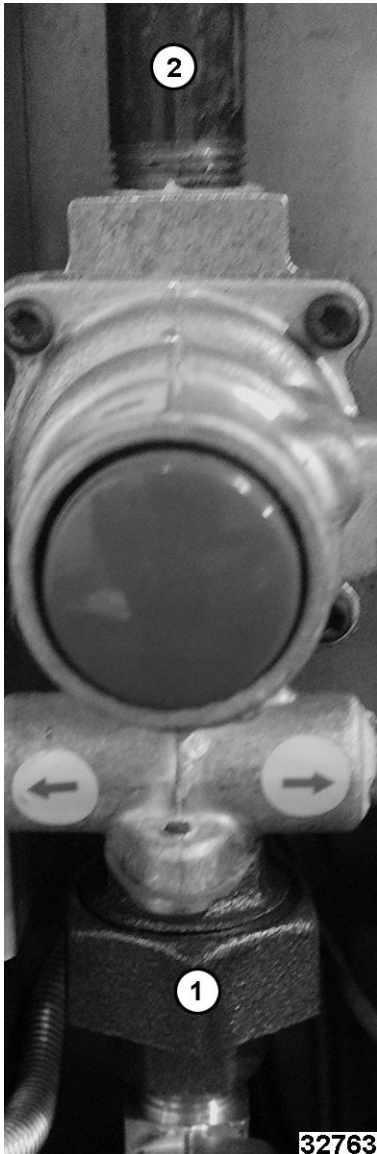


Fig. 22

4. Remove pilot safety valve from gas mount bracket.

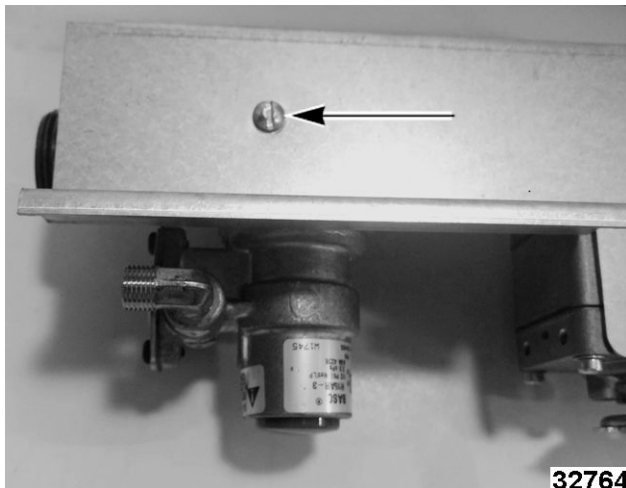


Fig. 23

5. Remove residual tape from fitting and pipe nipple.
6. Apply new gas-rated Teflon tape to pipe nipple and fitting.

**⚠ WARNING**

Clean pipe threads and apply thread sealant that is suitable for use with propane gases.

**⚠ WARNING**

All gas joints disturbed during servicing must be checked for leaks. Check with a soap and water solution (bubbles). Do not use an open flame.

7. Reverse procedure to install.
8. Verify proper oven operation.

**SOLENOID, PILOT SAFETY AND GAS SHUT-OFF VALVE ASSEMBLY (C MODEL)**



**⚠ WARNING**

Disconnect the electrical power to the machine and follow lockout / tagout procedures.



**⚠ WARNING**

Shut off the gas before servicing the unit and follow lockout / tagout procedures.

1. Disconnect supply power and gas.
2. Remove OVEN CONTROL PANEL COVER.
3. Disconnect flex line from tee fitting (1, Fig. 24) below manual gas shut-off valve.

**PREVIOUS PRODUCTION**



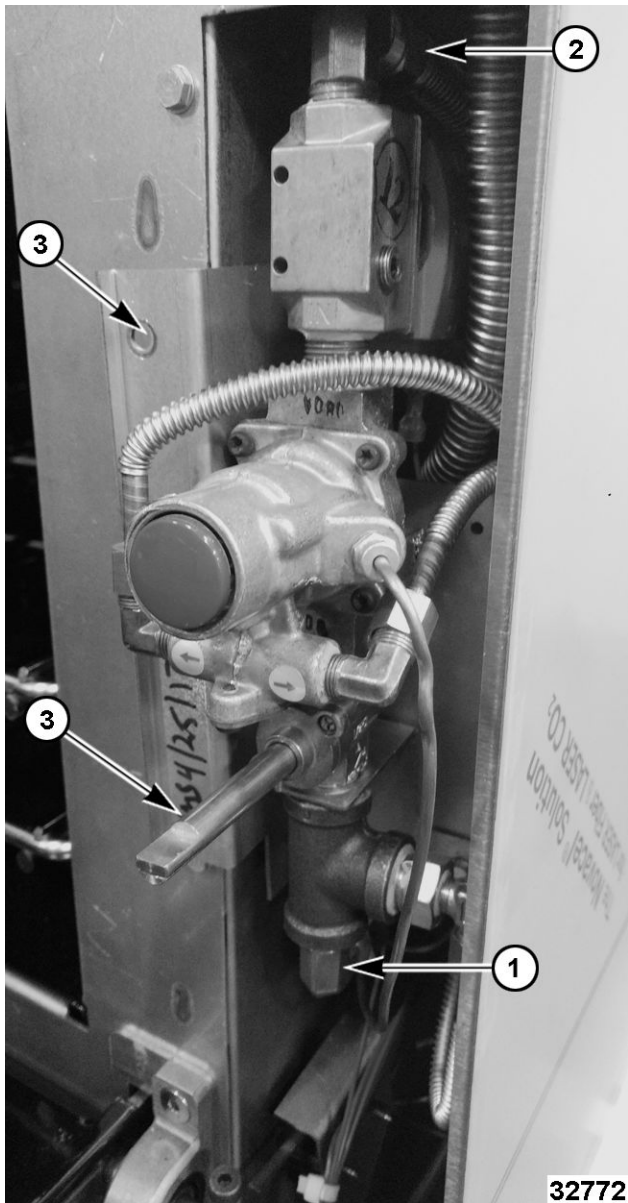


Fig. 24

32772

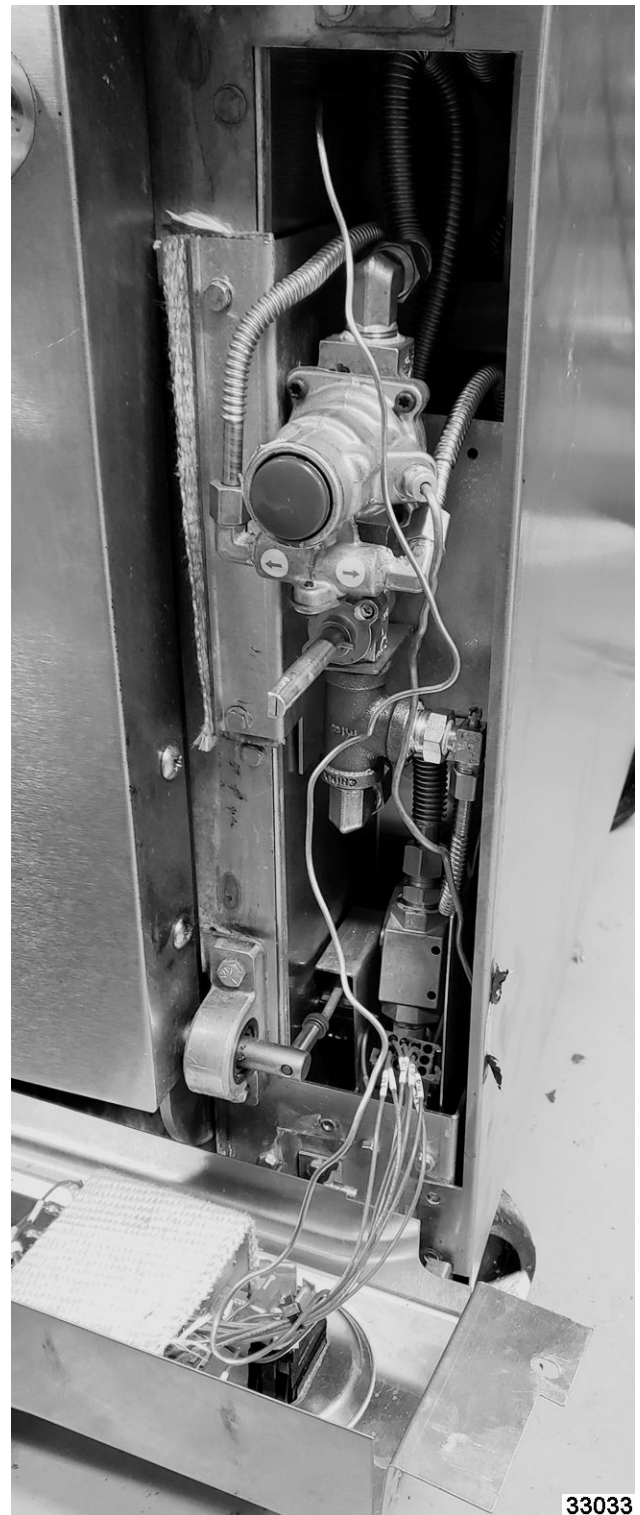


Fig. 25

33033

**CURRENT PRODUCTION**

4. Disconnect flex line (2, Fig. 24) from top of solenoid.
5. Remove screws (3, Fig. 24) securing gas mount bracket.

6. Remove gas mount bracket with solenoid, pilot safety and manual gas shut-off valve assembly from oven.
7. Remove residual tape from fittings and pipe nipples.
8. Apply new gas-rated thread sealant to pipe nipples and fittings.

**⚠ WARNING**

All gas joints disturbed during servicing must be checked for leaks. Check with a soap and water solution (bubbles). Do not use an open flame.

**⚠ WARNING**

Clean pipe threads and apply thread sealant that is suitable for use with propane gases.

9. Reverse procedure to install.
10. Verify proper oven operation.

**PILOT SAFETY VALVE (C MODEL)**



**⚠ WARNING**

Disconnect the electrical power to the machine and follow lockout / tagout procedures.



**⚠ WARNING**

Shut off the gas before servicing the unit and follow lockout / tagout procedures.

1. Disconnect supply power and gas.
2. Remove SOLENOID, PILOT SAFETY AND GAS SHUT-OFF VALVE ASSEMBLY (C MODEL).
3. Remove fitting (1, Fig. 26) and flex line (2, Fig. 26) from pilot safety valve.

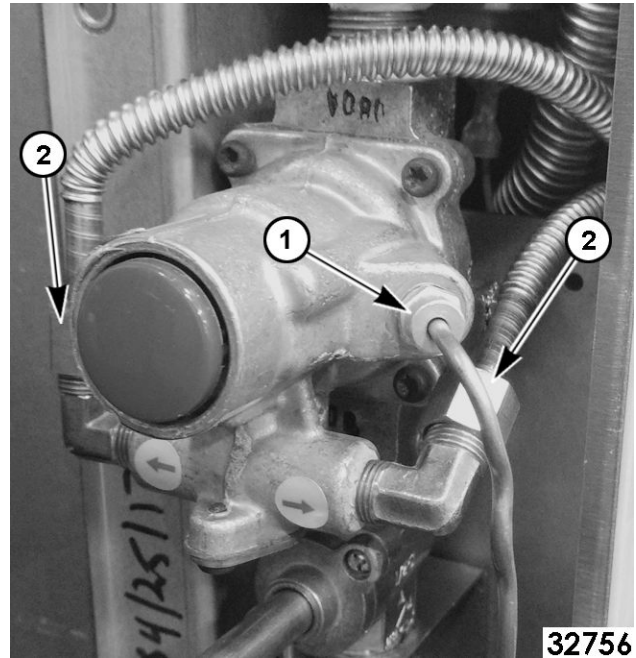


Fig. 26

4. Remove pilot safety valve from gas mount bracket.

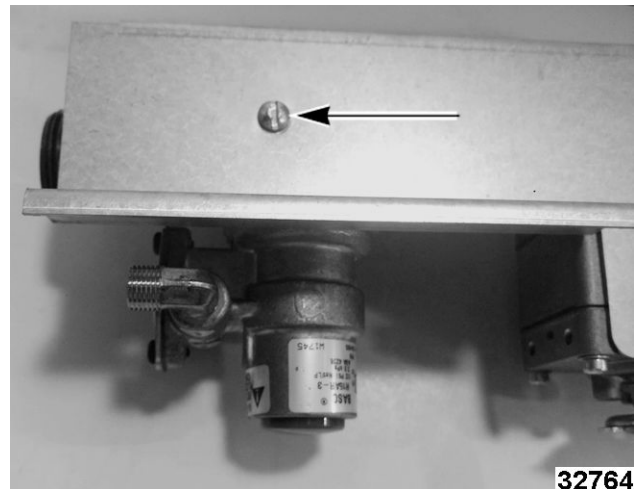


Fig. 27

5. Remove pipe nipple and manual gas shut-off valve from pilot safety valve.
6. Remove residual tape from fittings and pipe nipples.
7. Apply new gas-rated thread sealant to pipe nipples and fittings.

**⚠ WARNING**

All gas joints disturbed during servicing must be checked for leaks. Check with a soap and water solution (bubbles). Do not use an open flame.

8. Reverse procedure to install.

- Verify proper oven operation.

## TEMPERATURE CONTROL (THERMOSTAT) (S MODEL)



### ⚠ WARNING

Disconnect the electrical power to the machine and follow lockout / tagout procedures.

### ⚠ WARNING

All gas joints disturbed during servicing must be checked for leaks. Check with a soap and water solution (bubbles). Do not use an open flame.

- Disconnect supply power and gas.
- Remove PILOT SAFETY VALVE AND TEMPERATURE CONTROL ASSEMBLY (S MODEL).
- Remove screw (1, Fig. 28) securing temperature control to gas mount bracket.

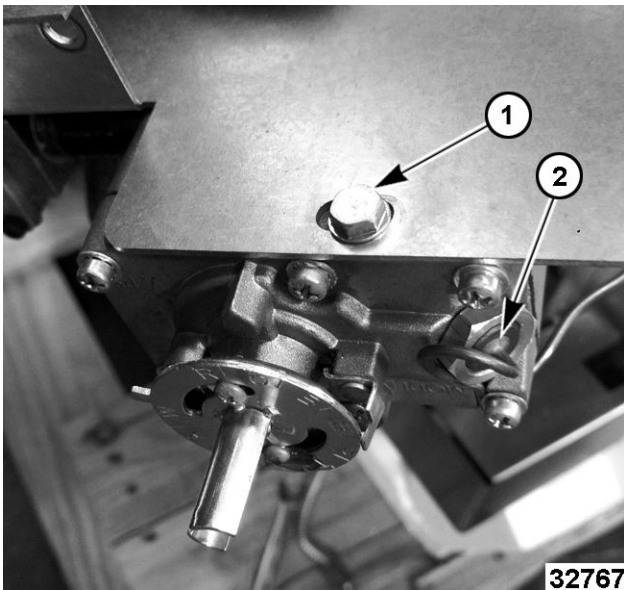


Fig. 28

Remove capillary (2, Fig. 28).

- Remove temperature control from pipe nipple.

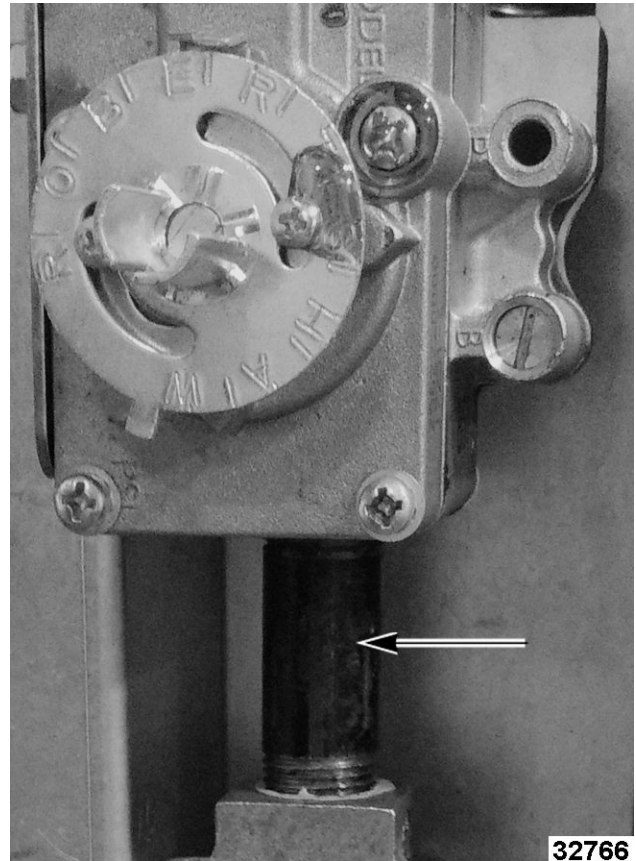


Fig. 29

- Remove residual tape from fitting and pipe nipple.
- Remove capillary.
  - Remove capillary bracket in oven cavity.



Fig. 30

- Route capillary through oven cavity wall.
  - Reverse Step 6 to replace capillary.
- Apply new gas-rated thread sealant to pipe nipple and fitting.

**⚠ WARNING**

Clean pipe threads and apply thread sealant that is suitable for use with propane gases.

**⚠ WARNING**

All gas joints disturbed during servicing must be checked for leaks. Check with a soap and water solution (bubbles). Do not use an open flame.

8. Reverse procedure to install.
9. Verify proper oven operation.

**TEMPERATURE CONTROL  
(THERMOSTAT) C MODEL**



**⚠ WARNING**

Disconnect the electrical power to the machine and follow lockout / tagout procedures.



**⚠ WARNING**

Shut off the gas before servicing the unit and follow lockout / tagout procedures.



**NOTE:** Video to show thermostat capillary removal and install in [Step 10](#).

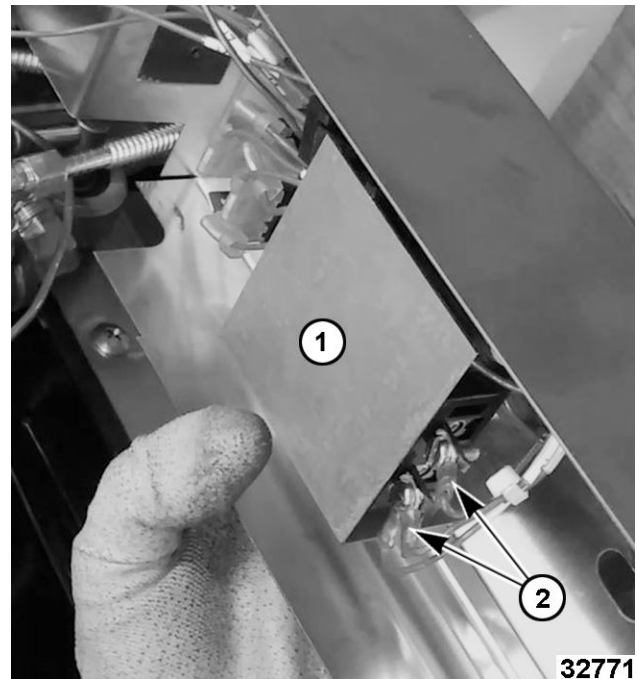
1. Disconnect supply power and gas.
2. Remove OVEN CONTROL PANEL COVER.
3. Remove temperature control from mount bracket.



**Fig. 32**

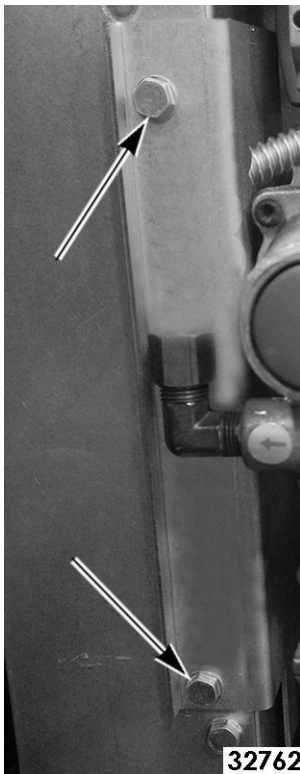
4. Remove electrical cover (1, [Fig. 33](#)). Note and disconnect temperature control electrical connectors (2, [Fig. 33](#)).

**NOTE:** Shield (1, [Fig. 33](#)) is installed on previous production units, not on current production.

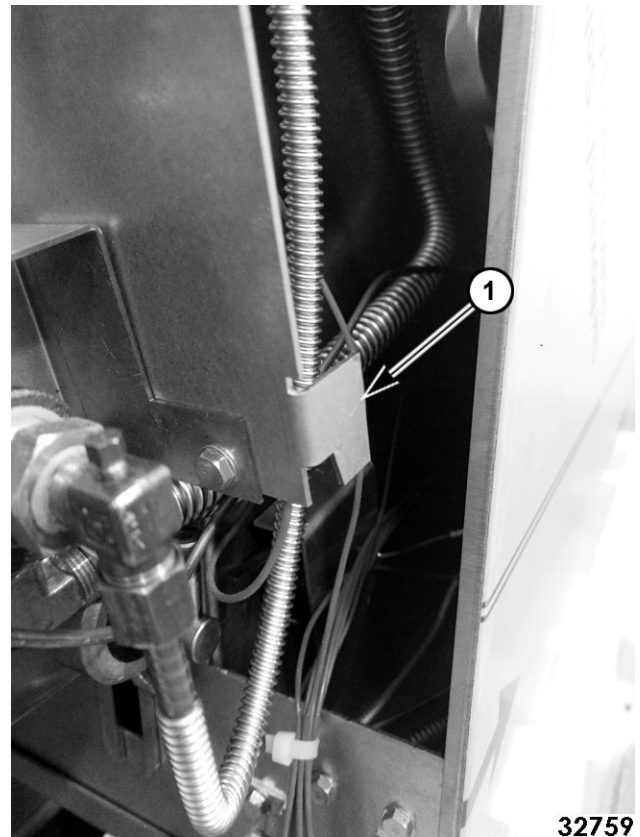


**Fig. 33**

5. Remove screws securing gas mount bracket to oven.

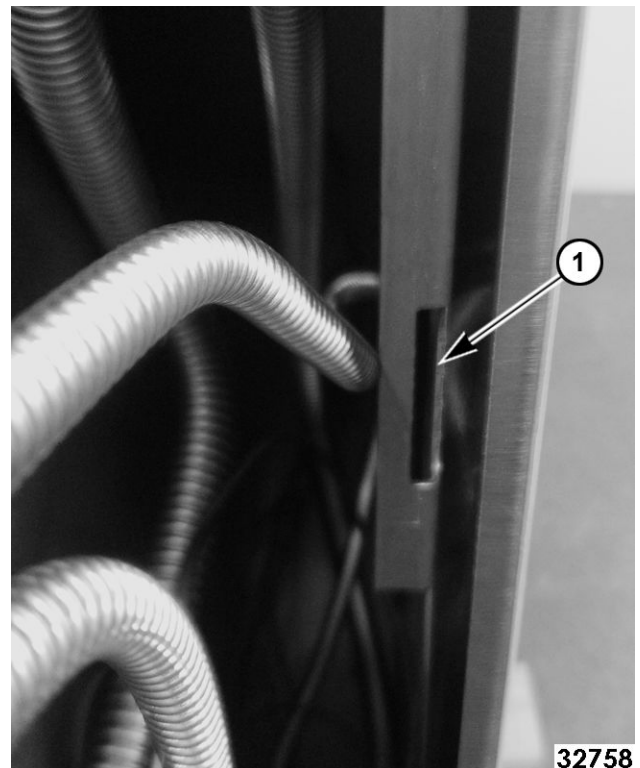


**Fig. 34**



**Fig. 35**

6. Lift up gas mount bracket to release hook (1, Fig. 35) off inner tab (1, Fig. 35). Pull out pilot safety valve and temperature control bracket assembly from oven.



**Fig. 36**

7. Flex heat shield and pull out.



Fig. 37

8. Remove capillary bracket and access panel in oven cavity.

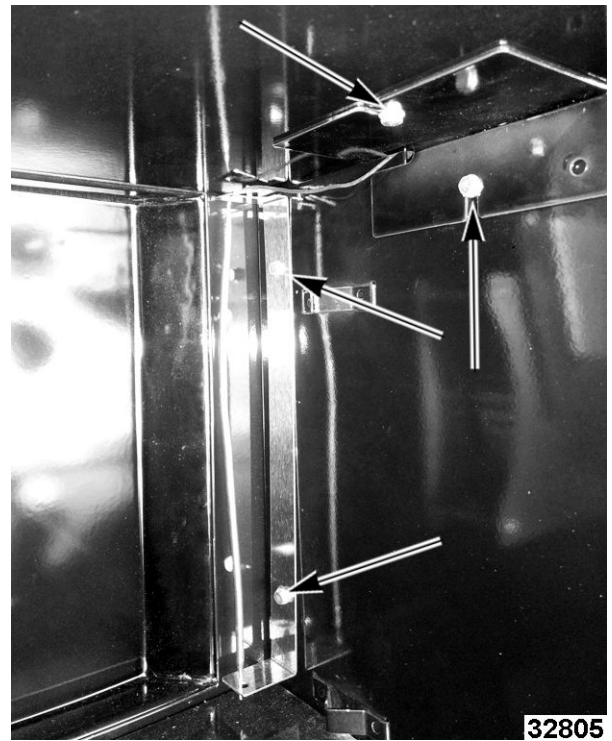


Fig. 38

9. Tape flexible cord to end of capillary in two places.

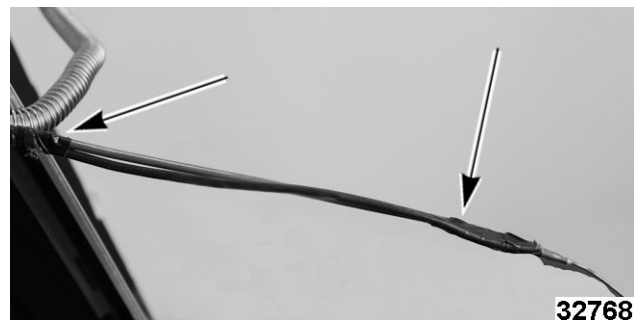


Fig. 39

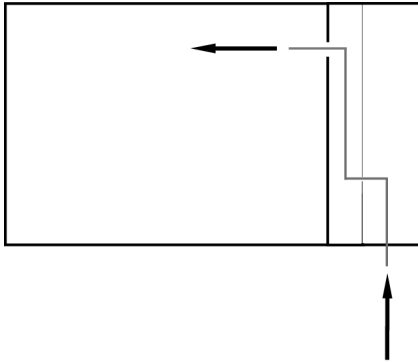


**NOTE:** Link to video of removal and installation of capillary ([Thermostat Capillary](#)).

10. Route capillary through oven side panels.



TOP VIEW OF THERMOSTAT  
CAPILLARY ROUTING  
(CONVECTION OVEN SHOWN)



AI4928

Fig. 41

11. Disconnect flexible cord from capillary and tape to replacement capillary.
12. Reverse procedure to install.

**⚠ WARNING**

Clean pipe threads and apply thread sealant that is suitable for use with propane gases.

**⚠ WARNING**

All gas joints disturbed during servicing must be checked for leaks. Check with a soap and water solution (bubbles). Do not use an open flame.

13. Verify proper oven operation.

### SOLENOID (C MODEL)



**⚠ WARNING**

Disconnect the electrical power to the machine and follow lockout / tagout procedures.



**⚠ WARNING**

Shut off the gas before servicing the unit and follow lockout / tagout procedures.

1. Disconnect supply power and gas.
2. Remove SOLENOID, PILOT SAFETY AND GAS SHUT-OFF VALVE ASSEMBLY (C MODEL).
3. Remove solenoid (1, Fig. 42) from pipe nipple.

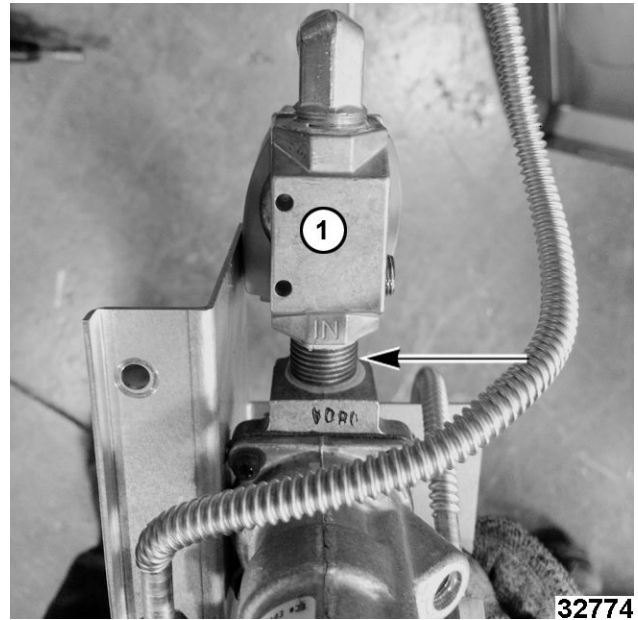


Fig. 42

4. Remove residual tape from fittings and pipe nipples.
5. Apply new gas-rated Teflon tape to pipe nipples and fittings.

**⚠ WARNING**

All gas joints disturbed during servicing must be checked for leaks. Check with a soap and water solution (bubbles). Do not use an open flame.

**⚠ WARNING**

Clean pipe threads and apply thread sealant that is suitable for use with propane gases.

6. Reverse procedure to install.
7. Verify proper oven operation.

### MANUAL GAS SHUT-OFF VALVE (C MODEL)



**⚠ WARNING**

Disconnect the electrical power to the machine and follow lockout / tagout procedures.



**⚠ WARNING**

Shut off the gas before servicing the unit and follow lockout / tagout procedures.

1. Disconnect supply power and gas.

2. Remove SOLENOID, PILOT SAFETY AND GAS SHUT-OFF VALVE ASSEMBLY (C MODEL).
3. Remove flex line and tee fitting (1, Fig. 43) from bottom of manual gas shut-off valve (2, Fig. 43).

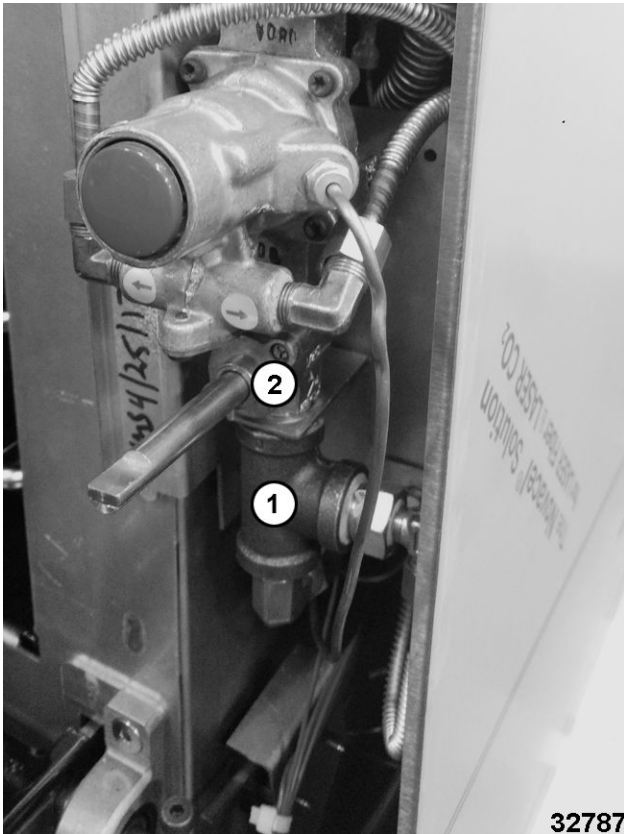


Fig. 43

4. Remove screw securing manual gas shut-off valve to gas mount bracket.
5. Remove manual gas shut off valve from pilot safety valve.
6. Remove residual tape from fittings and pipe nipples.
7. Apply new gas-rated thread sealant to pipe nipple and fitting.

**⚠ WARNING**

All gas joints disturbed during servicing must be checked for leaks. Check with a soap and water solution (bubbles). Do not use an open flame.

**⚠ WARNING**

Clean pipe threads and apply thread sealant that is suitable for use with propane gases.

8. Reverse procedure to install.
9. Verify proper oven operation.

**OVEN PILOT ASSEMBLY (C MODEL)**



**⚠ WARNING**

Disconnect the electrical power to the machine and follow lockout / tagout procedures.



**⚠ WARNING**

Shut off the gas before servicing the unit and follow lockout / tagout procedures.

1. Disconnect supply power and gas.
2. Remove KICK PANEL.
3. Remove exhaust baffle.



Fig. 44

**NOTICE**

Oven can experience nuisance drop outs of the pilot if exhaust baffle is not reinstalled.

4. Remove gas flex line to burner nozzle.

**PREVIOUS PRODUCTION SHOWN**

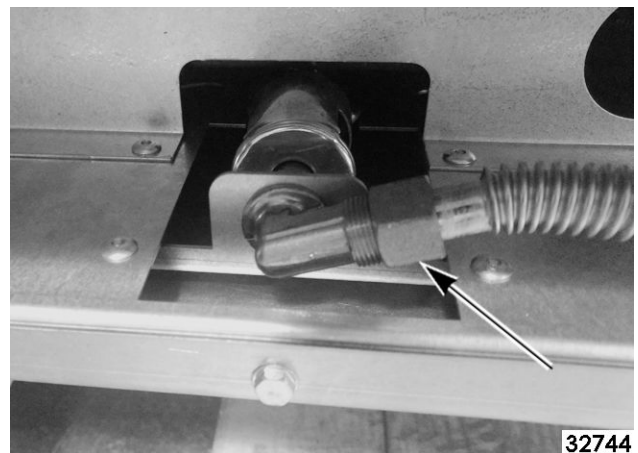


Fig. 45

**CURRENT PRODUCTION SHOWN**





Fig. 46

5. Remove bolts securing burner drawer box to oven.
6. Pull burner drawer box (1, Fig. 47) out from the oven.

**PREVIOUS PRODUCTION SHOWN**

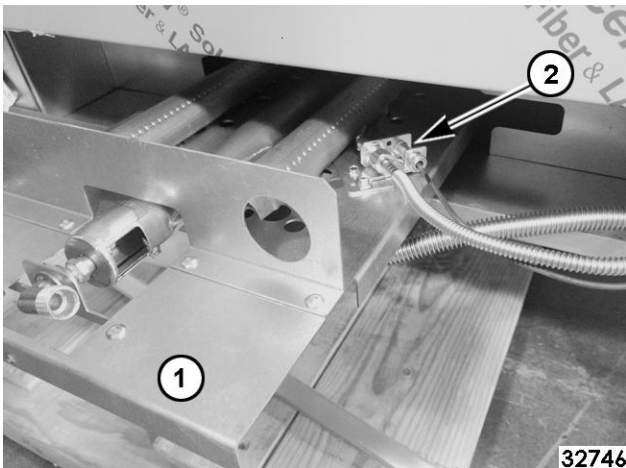


Fig. 47

7. Remove pilot assembly (2, Fig. 47) from oven deflector.

**PREVIOUS PRODUCTION SHOWN**

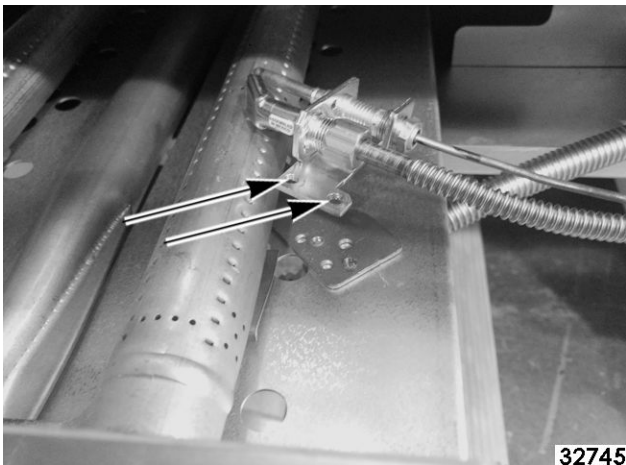


Fig. 48

**CURRENT PRODUCTION SHOWN**

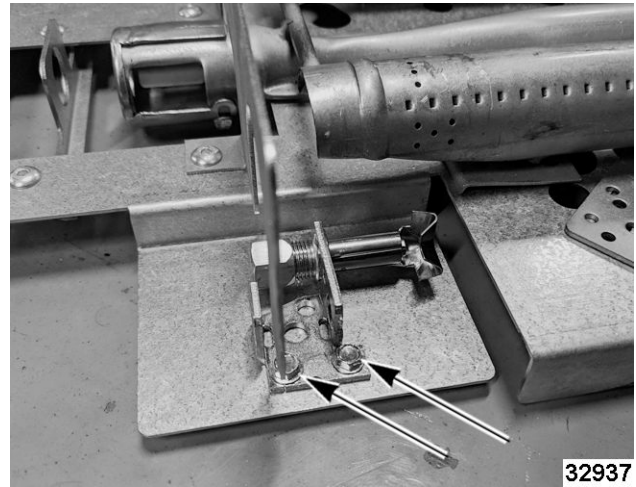


Fig. 49

**⚠ WARNING**

All gas joints disturbed during servicing must be checked for leaks. Check with a soap and water solution (bubbles). Do not use an open flame.

8. Disconnect gas flex line and capillary nuts from pilot assembly.
9. Reverse procedure to install.
10. Verify proper oven operation.

**OVEN PILOT ASSEMBLY (S MODELS)**



**⚠ WARNING**

Disconnect the electrical power to the machine and follow lockout / tagout procedures.



**⚠ WARNING**

Shut off the gas before servicing the unit and follow lockout / tagout procedures.

1. Disconnect supply power and gas.
2. Remove OVEN CAVITY BOTTOM PANEL.
3. Remove pilot burner assembly mounting screws.

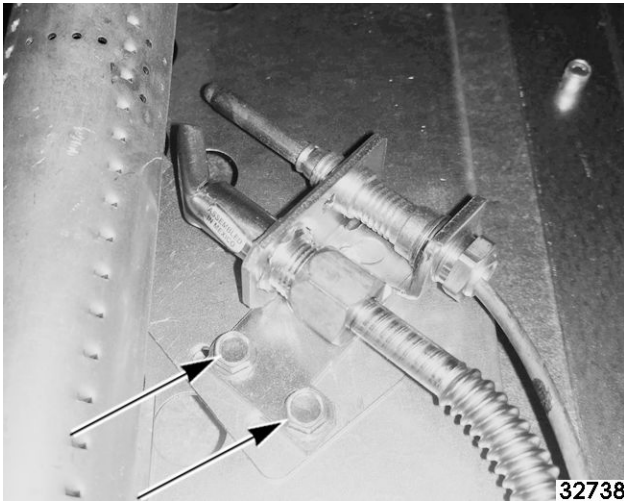


Fig. 50

4. Disconnect gas flex line and capillary nuts from pilot assembly.
5. Reverse procedure to install.

**⚠ WARNING**

All gas joints disturbed during servicing must be checked for leaks. Check with a soap and water solution (bubbles). Do not use an open flame.

**⚠ WARNING**

Clean pipe threads and apply thread sealant that is suitable for use with propane gases.

6. Verify proper oven operation.

**OVEN BURNER ASSEMBLY**



**⚠ WARNING**

Disconnect the electrical power to the machine and follow lockout / tagout procedures.



**⚠ WARNING**

Shut off the gas before servicing the unit and follow lockout / tagout procedures.

**NOTE:** In standard ovens you can remove oven cavity bottom panel for servicing burner and pilot assembly. Convection ovens do not have a removable oven cavity bottom panel. Refer to: OVEN CAVITY BOTTOM PANEL (S MODEL).

1. Disconnect supply power and gas.
2. Remove KICK PANEL.

3. Remove exhaust baffle.



Fig. 51

**NOTICE**

Oven can experience nuisance drop outs of the pilot if exhaust baffle is not reinstalled.

4. Remove gas flex line to burner nozzle.

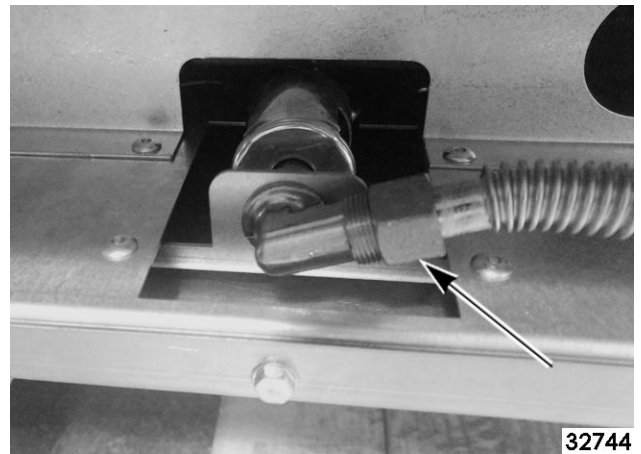


Fig. 52

5. Remove screw securing burner drawer box to oven.

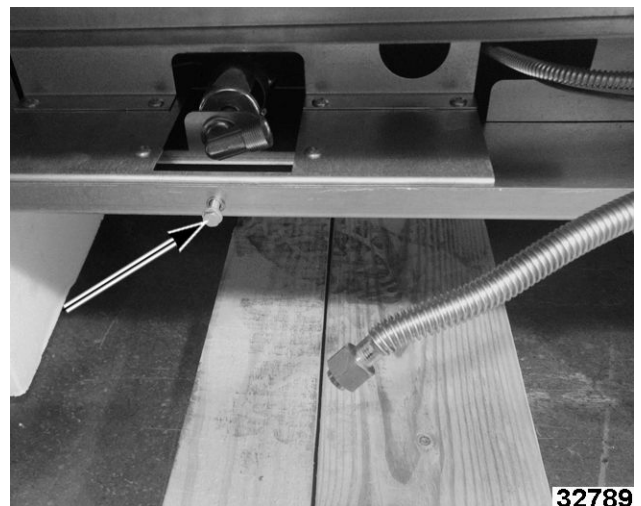


Fig. 53

6. Lift and pull burner drawer box (1, Fig. 54) out from oven until pilot burner is accessible.

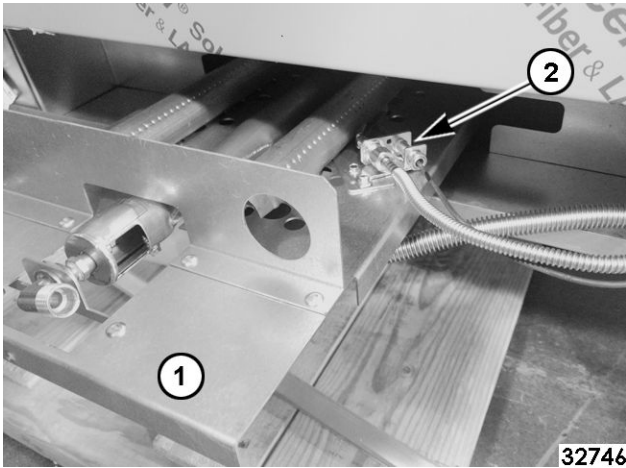


Fig. 54

7. Remove over burner assembly from oven.
8. Pull burner out and disconnect pilot gas tubing and thermocouple (2, Fig. 54).
9. Remove orifice elbow.

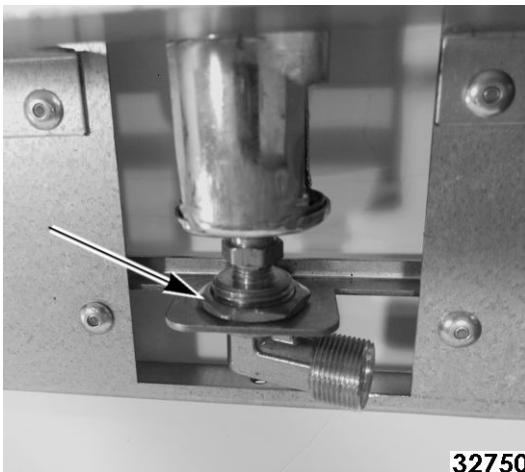


Fig. 55

10. Pry four tabs up to remove burner.

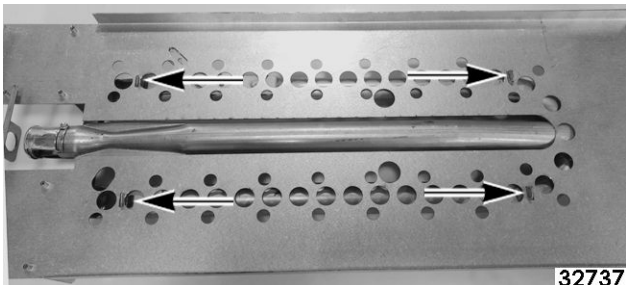


Fig. 56

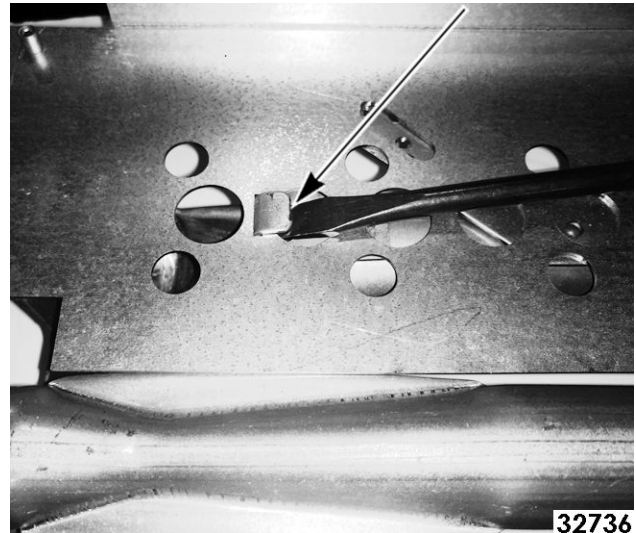


Fig. 57

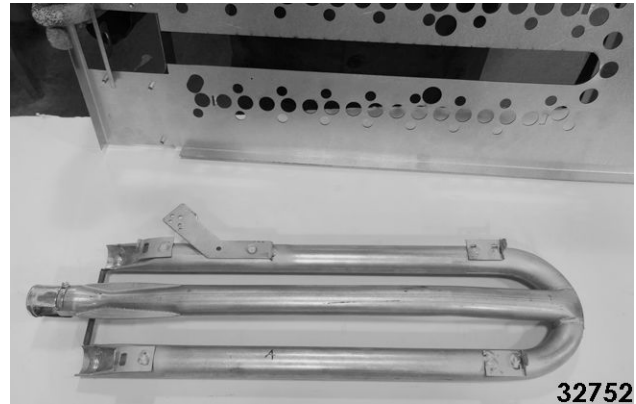


Fig. 58

11. Reverse procedure to install.

**⚠ WARNING**

All gas joints disturbed during servicing must be checked for leaks. Check with a soap and water solution (bubbles). Do not use an open flame.

**⚠ WARNING**

Clean pipe threads and apply thread sealant that is suitable for use with propane gases.

12. Verify proper oven operation.

## PILOT QUICK DISCONNECT VALVE



**⚠ WARNING**

Disconnect the electrical power to the machine and follow lockout / tagout procedures.



**⚠ WARNING**

Shut off the gas before servicing the unit and follow lockout / tagout procedures.

**NOTE:** There are three generations of pilot designs on open top burners. If servicing open top burners with first or second generation pilot design, use third generation replacement kit. Third generation is backwards compatible with form, fit and function.

1. Disconnect supply power and gas.
2. Remove MANIFOLD COVER.
3. Remove top burner grates and defectors.



Fig. 59

4. Disconnect pilot coupler from the pilot valve.

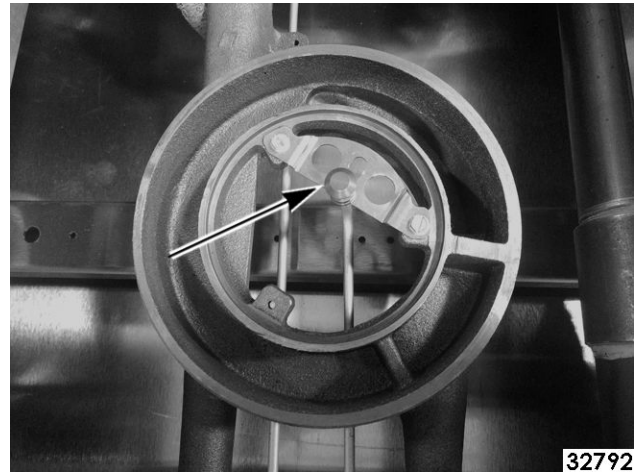


Fig. 60

5. Disconnect pilot valve from the gas manifold.

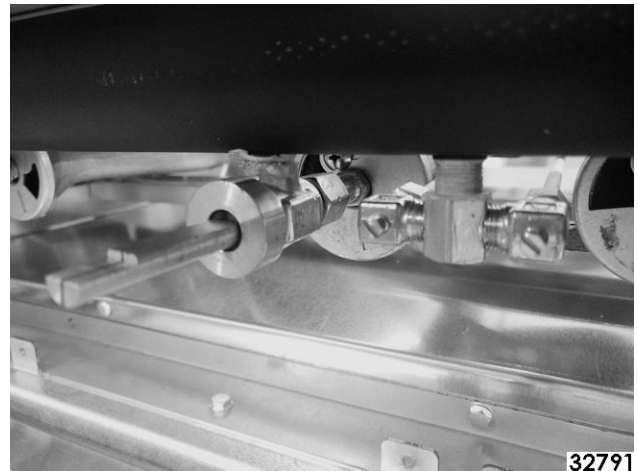


Fig. 61

6. Remove residual tape from fittings.
7. Apply new gas-rated thread sealant.

**⚠ WARNING**

All gas joints disturbed during servicing must be checked for leaks. Check with a soap and water solution (bubbles). Do not use an open flame.

**⚠ WARNING**

Clean pipe threads and apply thread sealant that is suitable for use with propane gases.

8. Reverse procedure to install.
9. Verify proper oven operation.

**TOP SECTION BURNER (OPEN TOP)**



**⚠ WARNING**

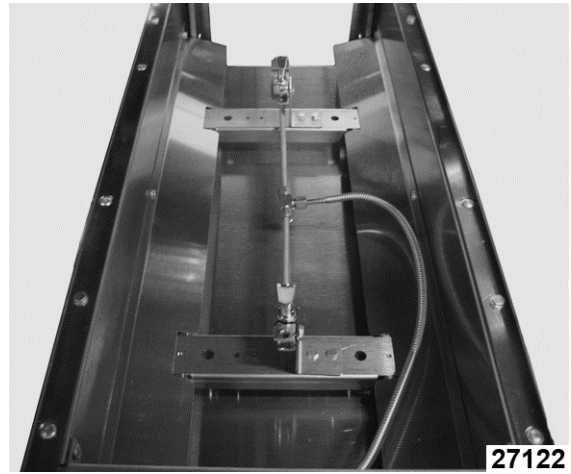
Disconnect the electrical power to the machine and follow lockout / tagout procedures.



**⚠ WARNING**

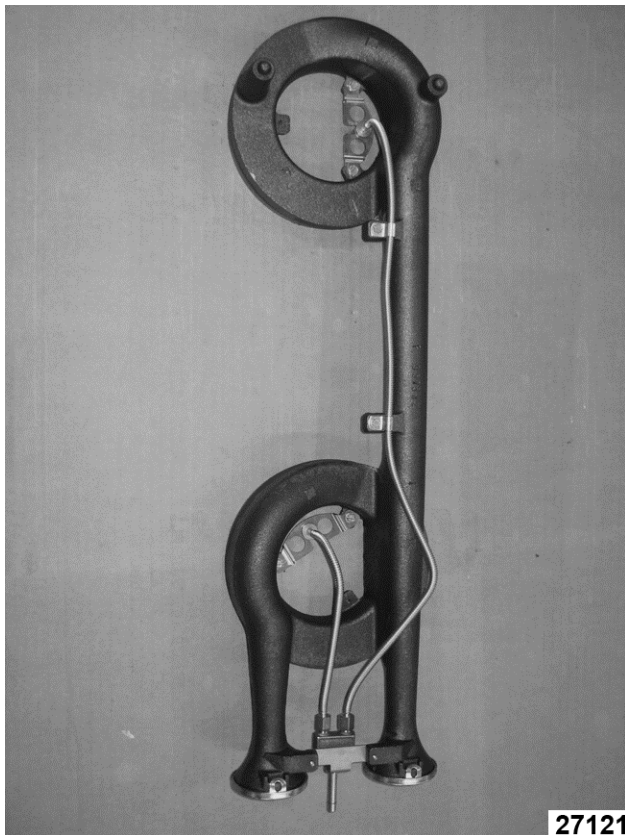
Shut off the gas before servicing the unit and follow lockout / tagout procedures.

**NOTE:** There are three generations of pilot designs on open top burners. If servicing open top burners with first or second generation pilot design, use third generation replacement kit. Third generation is backwards compatible with form, fit and function.



27122

**2nd GENERATION**



27121

**1st GENERATION**



32807

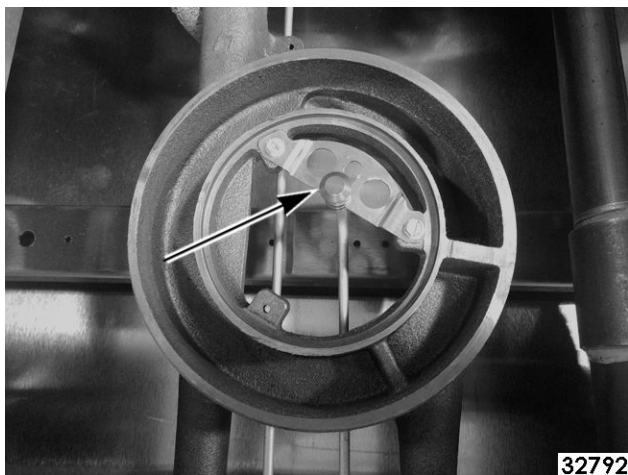
**3rd GENERATION**

1. Disconnect supply power and gas.
2. Remove MANIFOLD COVER.
3. Remove burner grates and deflectors. (optional)



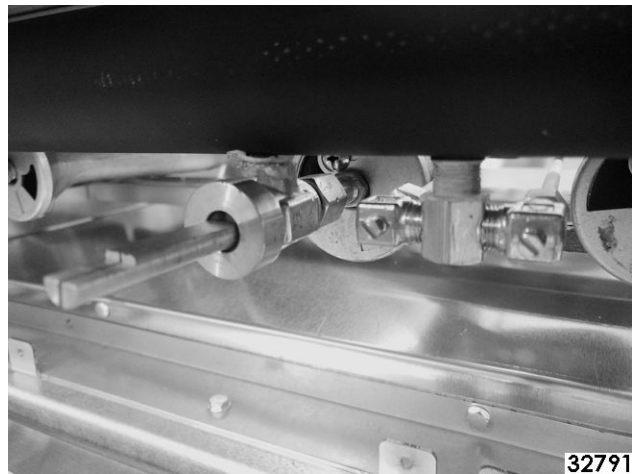
**Fig. 65**

4. Remove burner heads.
5. Remove (unsnap) pilot burner from front and rear burner.



**Fig. 66**

6. Lift rear of burner, slide burner back, and lift to disengage from control valves.



**Fig. 67**

7. Repeat Step 3 through Step 6 for each burner.
8. Remove residual tape from fittings.
9. Apply new gas-rated thread sealant.

**⚠ WARNING**

**All gas joints disturbed during servicing must be checked for leaks. Check with a soap and water solution (bubbles). Do not use an open flame.**

**⚠ WARNING**

**Clean pipe threads and apply thread sealant that is suitable for use with propane gases.**

10. Reverse procedure to install.
11. Verify proper oven operation.



## TOP SECTION BURNER (CHAR BROILER)



**⚠ WARNING**

Shut off the gas before servicing the unit and follow lockout / tagout procedures.



**⚠ WARNING**

Disconnect the electrical power to the machine and follow lockout / tagout procedures.

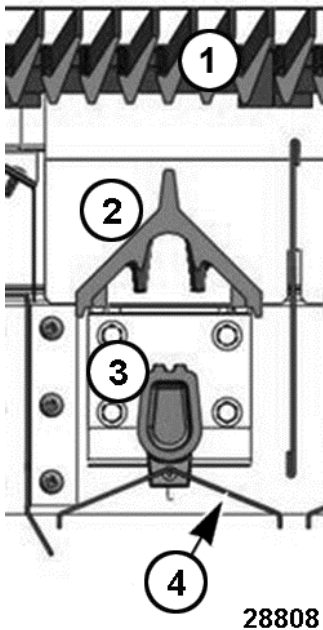


Fig. 68

### Charbroiler Burner Components - Front View

- [1] Grate
- [2] Radiant
- [3] Burner
- [4] Deflector

1. Remove MANIFOLD COVER.
2. Remove grate (1, Fig. 69) from charbroiler.

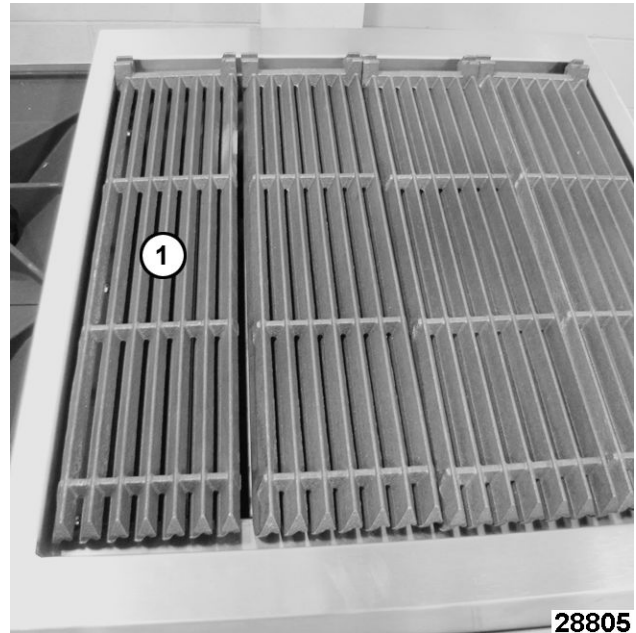


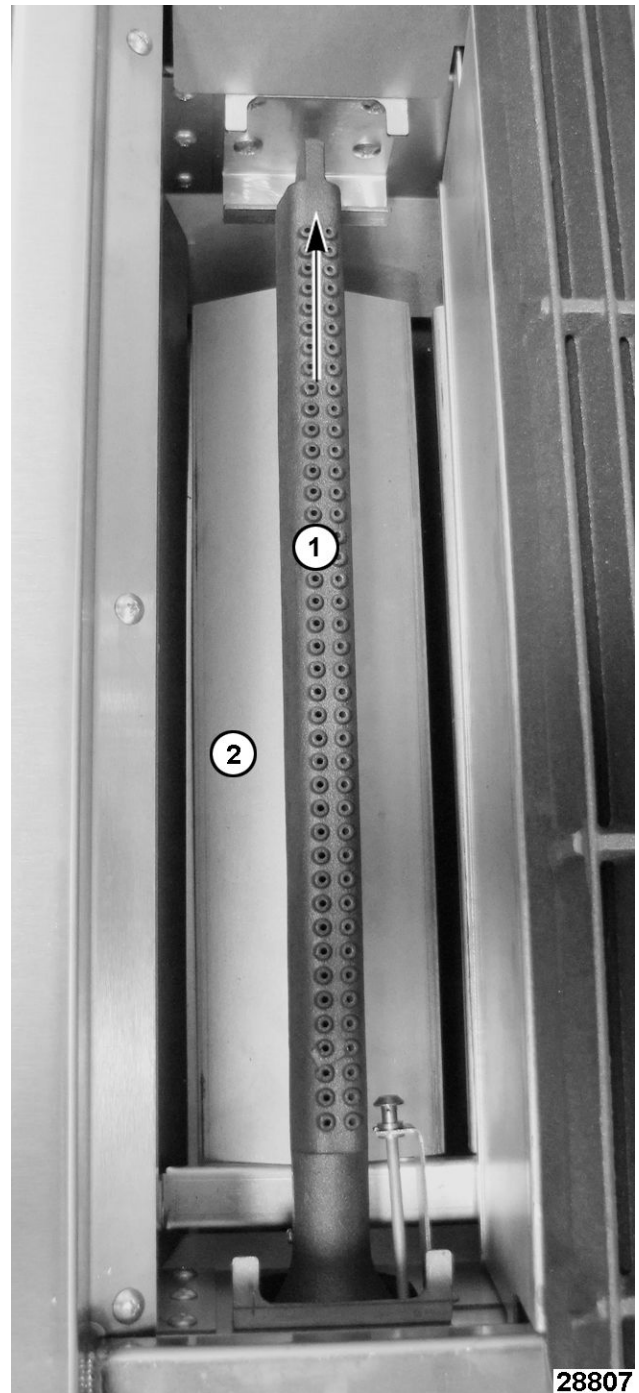
Fig. 69

3. Remove radiant (1, Fig. 70) to access burner.



**Fig. 70**

4. Remove burner (1, [Fig. 71](#)) and deflector (2, [Fig. 71](#)) by lifting at the rear of burner.



**Fig. 71**

5. Remove burner rod (1, [Fig. 72](#)) securing deflector (2, [Fig. 72](#)) to burner.



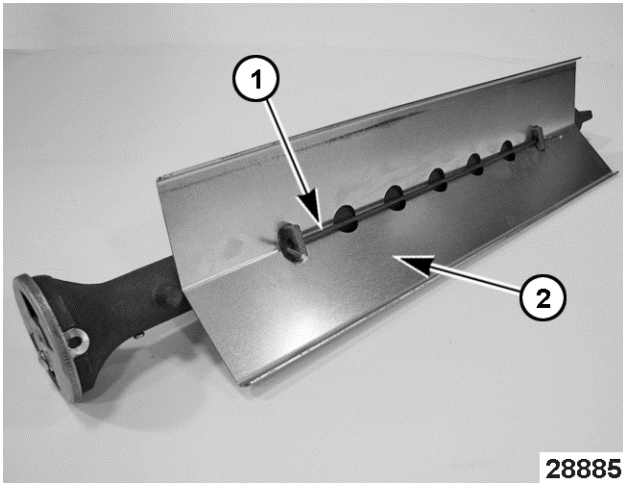


Fig. 72

6. To Install:
  - A. Install deflector onto replacement burner.
7. Verify BURNER AIR SHUTTER ADJUSTMENT.
8. Install radiant above the burner.
9. Install grate.
10. Check for proper operation.

## CHARBROILER PILOT



**WARNING**

Shut off the gas before servicing the unit and follow lockout / tagout procedures.



**WARNING**

Disconnect the electrical power to the machine and follow lockout / tagout procedures.

1. Remove TOP SECTION BURNER (CHAR BROILER).
2. Remove crumb tray.



Fig. 73

3. Remove MANIFOLD COVER to access pilot.

4. Remove compression nut from pilot valve then remove pilot tube assembly from valve.

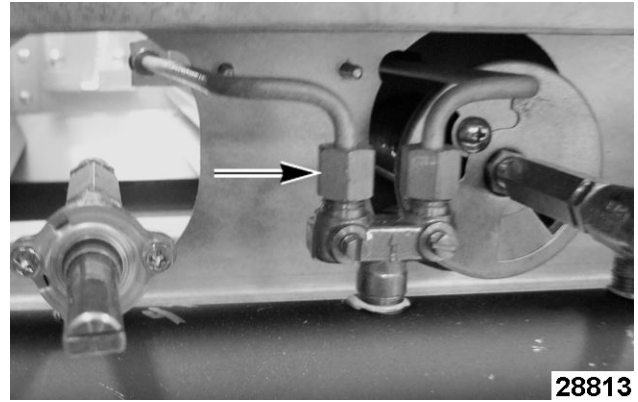


Fig. 74

5. Remove pilot tube assembly (1, Fig. 75) from pilot bracket (2, Fig. 75). Use pliers to separate as needed.

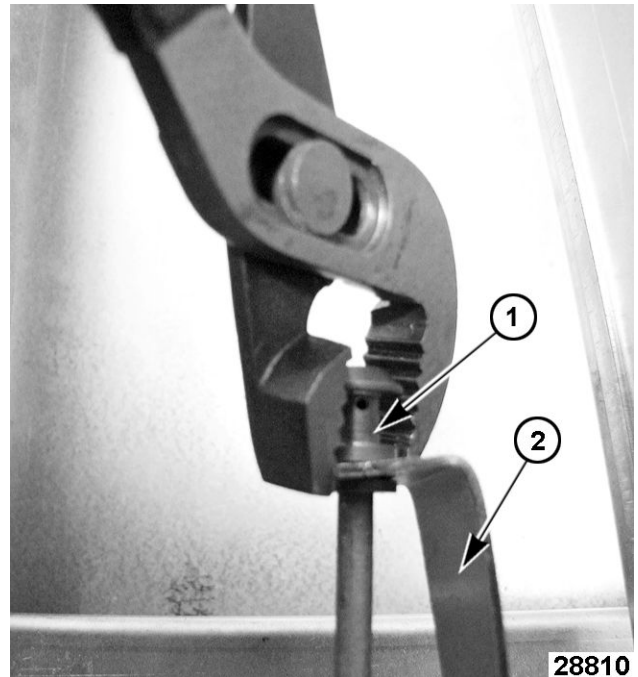


Fig. 75

**WARNING**

All gas joints disturbed during servicing must be checked for leaks. Check with a soap and water solution (bubbles). Do not use an open flame.

**WARNING**

Clean pipe threads and apply thread sealant that is suitable for use with propane gases.

6. Reverse procedure to install.

**NOTE:** If replacing pilot and tubing, ensure a compression nut and ferrule are installed on the end of tubing that connects to pilot valve.

## TOP SECTION BURNER (FRENCH/ HOT TOP)



**⚠ WARNING**

Disconnect the electrical power to the machine and follow lockout / tagout procedures.



**⚠ WARNING**

Shut off the gas before servicing the unit and follow lockout / tagout procedures.

1. Disconnect supply power and gas.
2. Remove MANIFOLD COVER.
3. Remove burner top plate (1, Fig. 76).

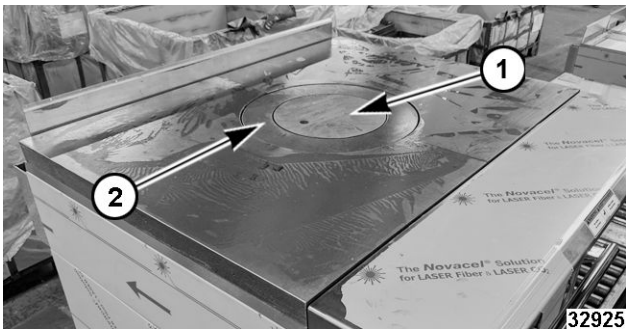


Fig. 76

4. Remove burner head 2, Fig. 76).
5. Remove burner plate(s).

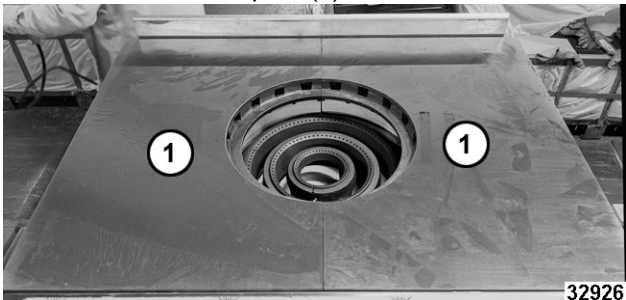


Fig. 77

6. Note and remove burner insulation.

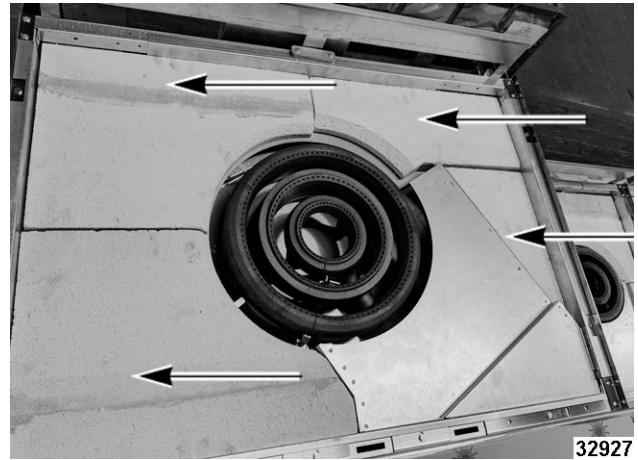


Fig. 78

**NOTE:** On production units build after April 2019, bricks were replaced with lava rocks. Bricks can be replaced with lava rocks if necessary.



Fig. 79

7. Remove burner gas flex lines (1, Fig. 80) in three places.

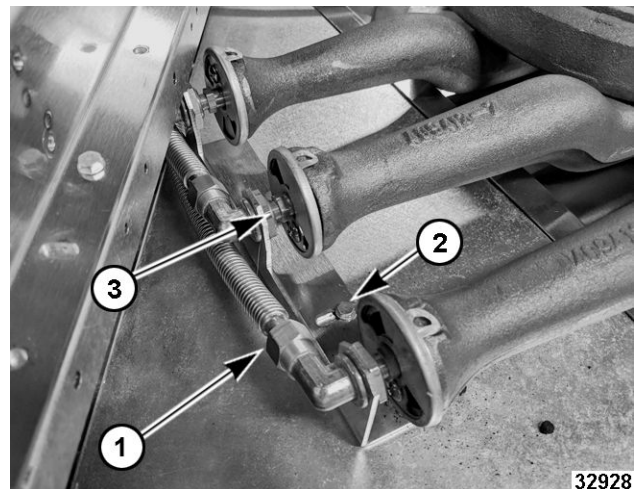


Fig. 80

8. Remove screws (2, Fig. 80) in two places securing burner nozzle mount bracket.

9. Remove burner nozzle bracket and burner nozzles (3, Fig. 80).
10. Remove outer, middle and inner burner rings.

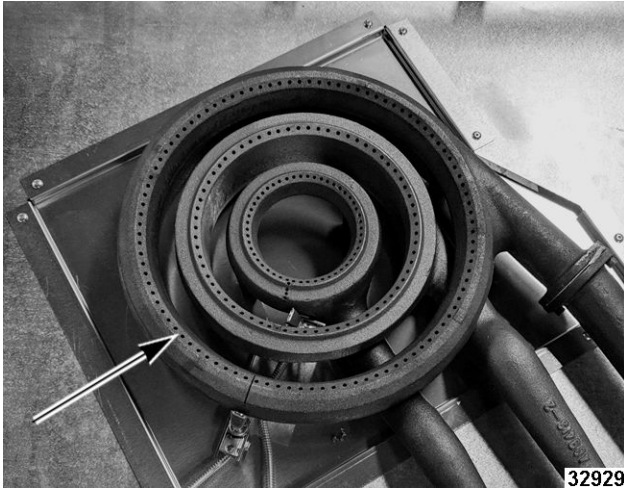


Fig. 81

11. Remove residual tape from fittings.
12. Apply new gas-rated Teflon tape to fittings.

**⚠ WARNING**

All gas joints disturbed during servicing must be checked for leaks. Check with a soap and water solution (bubbles). Do not use an open flame.

**⚠ WARNING**

Clean pipe threads and apply thread sealant that is suitable for use with propane gases.

13. Reverse procedure to install.
14. Verify proper oven operation.

**TOP SECTION BURNER CONTROL VALVE**



**⚠ WARNING**

Disconnect the electrical power to the machine and follow lockout / tagout procedures.



**⚠ WARNING**

Shut off the gas before servicing the unit and follow lockout / tagout procedures.

1. Disconnect supply power and gas.
2. Remove MANIFOLD COVER.

3. Remove BURNER.
4. Unscrew top burner control valve (1, Fig. 82) from gas manifold.

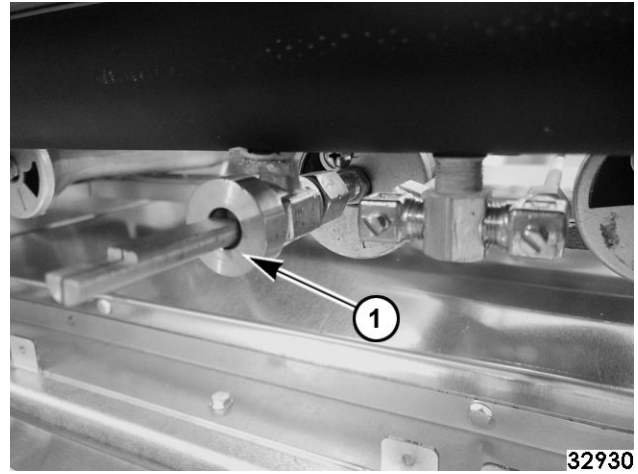


Fig. 82

5. Remove residual tape from fittings.
6. Apply new gas-rated Teflon tape.

**⚠ WARNING**

All gas joints disturbed during servicing must be checked for leaks. Check with a soap and water solution (bubbles). Do not use an open flame.

**⚠ WARNING**

Clean pipe threads and apply thread sealant that is suitable for use with propane gases.

7. Reverse procedure to install.
8. Verify proper oven operation.

**CONVECTION MOTOR FAN CONTROL SWITCH (C MODEL)**



**⚠ WARNING**

Disconnect the electrical power to the machine and follow lockout / tagout procedures.

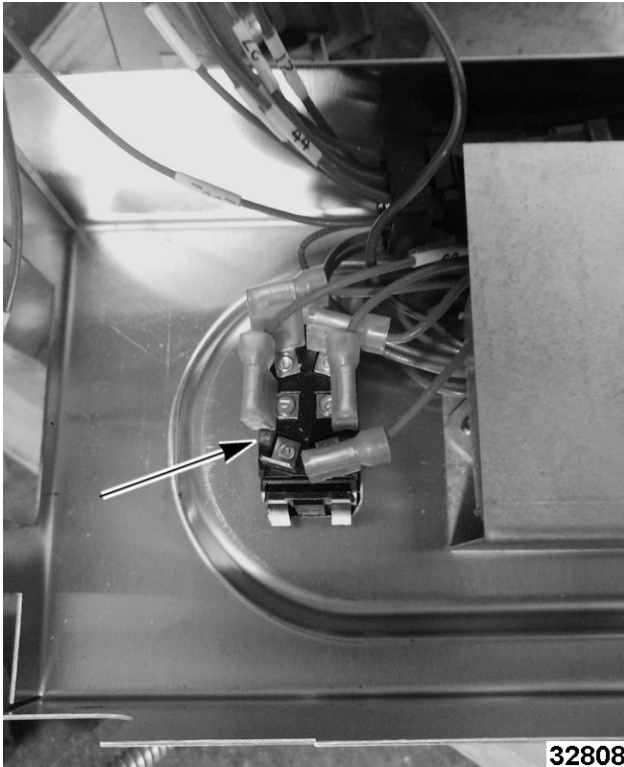


**⚠ WARNING**

Shut off the gas before servicing the unit and follow lockout / tagout procedures.

1. Disconnect supply power and gas.
2. Remove OVEN CONTROL PANEL COVER.

- Note and disconnect fan control switch wiring on back of cover.



**Fig. 83**

- Press lock tabs on sides of switch together to release from cover.
- Reverse procedure to install.
- Verify proper oven operation.

## CONVECTION MOTOR (C MODEL)



### **⚠ WARNING**

Disconnect the electrical power to the machine and follow lockout / tagout procedures.

### **⚠ WARNING**

Allow oven to cool completely before attempting to change convection motor.



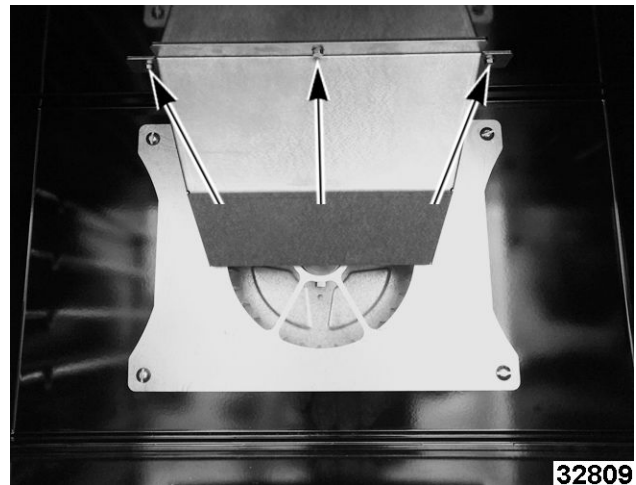
### **⚠ WARNING**

Shut off the gas before servicing the unit and follow lockout / tagout procedures.

### **NOTICE**

Place clean cardboard on bottom panel of oven cavity to protect surface when pulling motor in through cavity.

- Disconnect supply power and gas.
- Remove pans, oven racks and side racks inside oven.
- Remove flue intake assembly from inside oven.



**Fig. 84**

- Remove fan guard.

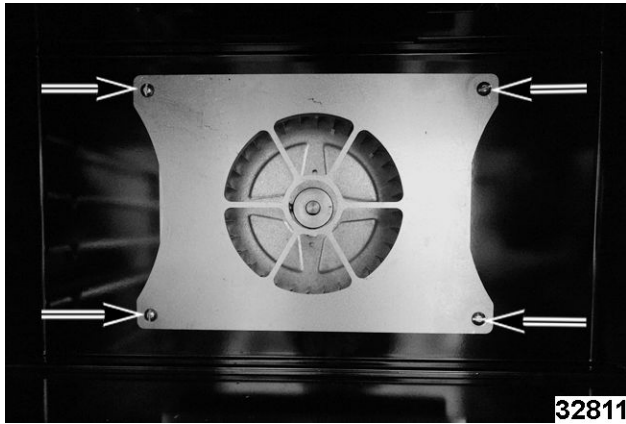


Fig. 85

**NOTE:** Set fan guard screw spacers (1, Fig. 86) aside.

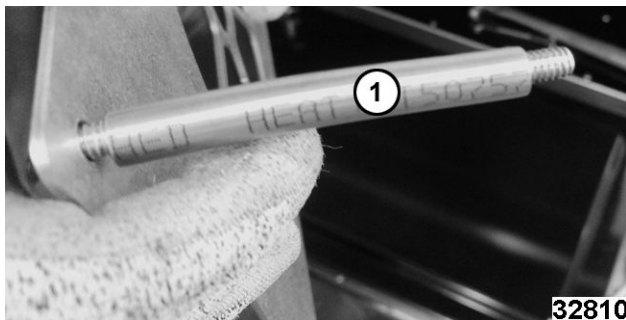


Fig. 86

- Remove convection fan blower.

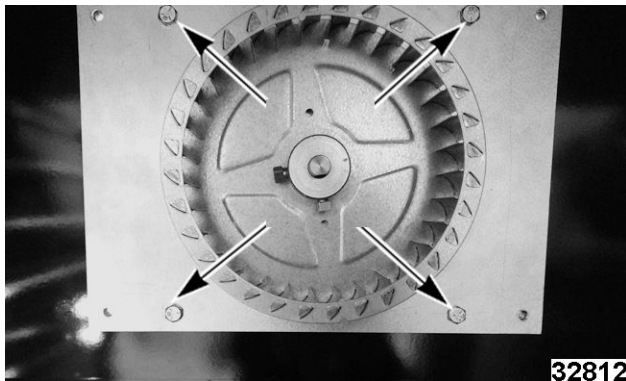


Fig. 87

- Remove motor mount plate bolts and pull motor into oven cavity onto cardboard.

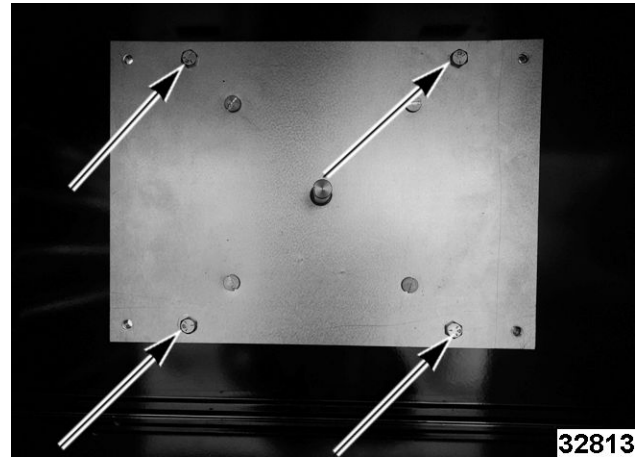


Fig. 88

- Remove motor insulation.
- Remove convection motor from brackets.
- Remove screws securing junction box cover.
- Note and disconnect convection motor electrical wires at junction box.
- Reverse procedure to install.
- Verify proper oven operation.

## OVEN DOOR



### ⚠ WARNING

Disconnect the electrical power to the machine and follow lockout / tagout procedures.



### ⚠ WARNING

Shut off the gas before servicing the unit and follow lockout / tagout procedures.

- Remove KICK PANEL.
- Remove OVEN CONTROL PANEL COVER.
- Remove left hinge access cover mounting screw.



Fig. 89

4. Pull out at bottom of door and lift up to disengage at top. Raise door up and pull off.



Fig. 90

## OVEN DOOR COUNTER WEIGHT AND BEARING BLOCK



### ⚠ WARNING

Disconnect the electrical power to the machine and follow lockout / tagout procedures.



### ⚠ WARNING

Shut off the gas before servicing the unit and follow lockout / tagout procedures.

1. Remove OVEN DOOR.
2. Remove bearing block screws.

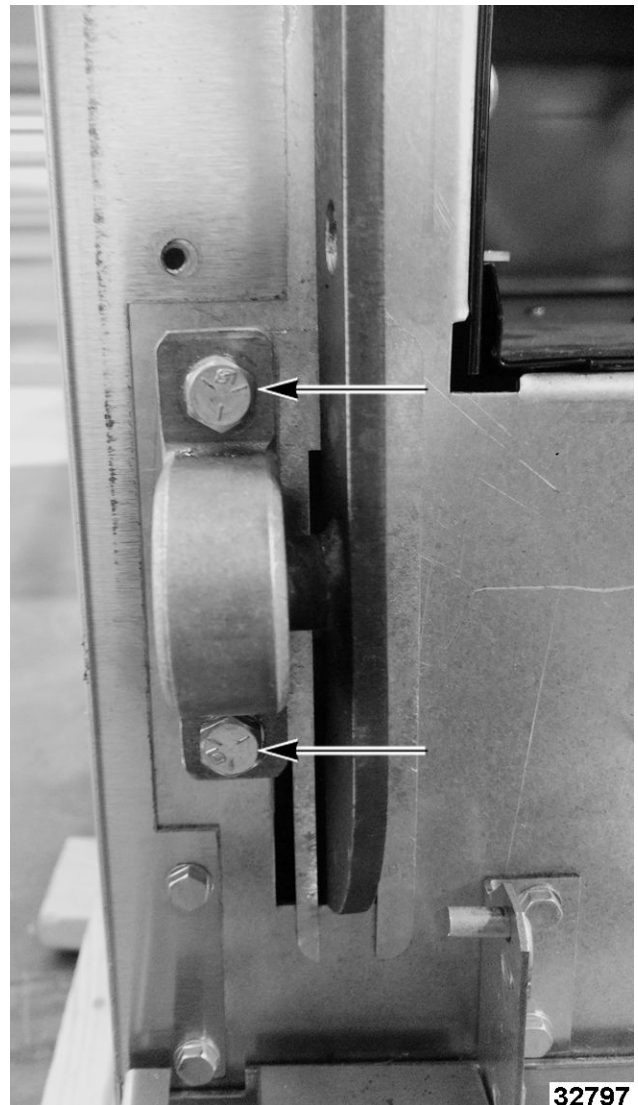
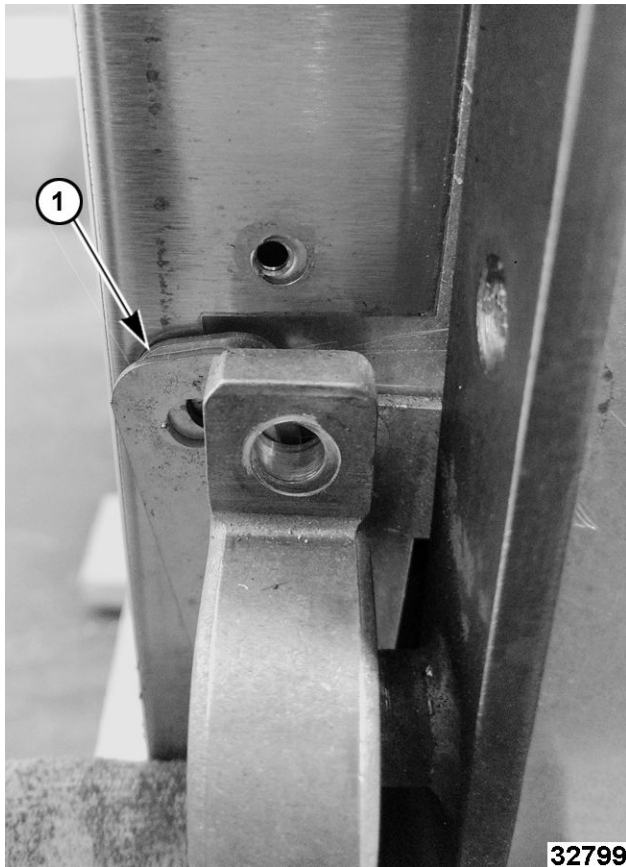


Fig. 91



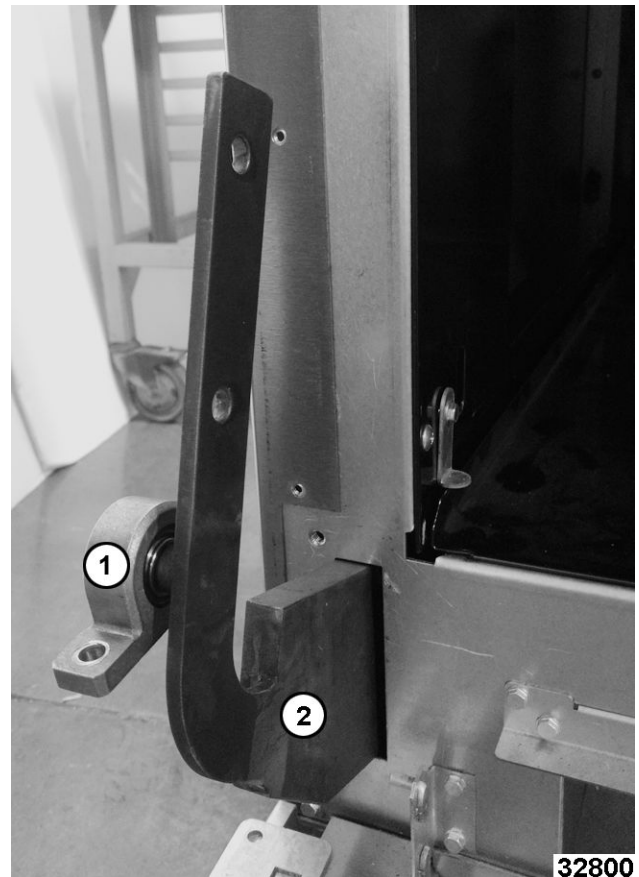
**NOTICE**

Shims (1, Fig. 92) are present behind bearing block. They must be replaced when installing bearing block.



**Fig. 92**

3. Slide up heat shield to remove.
4. Slide bearing (1, Fig. 93) off axle shaft.



**Fig. 93**

5. Slide counterweight (2, )Fig. 93 through opening.
6. **CONVECTION MODELS ONLY:** Remove right side shaft set screw.

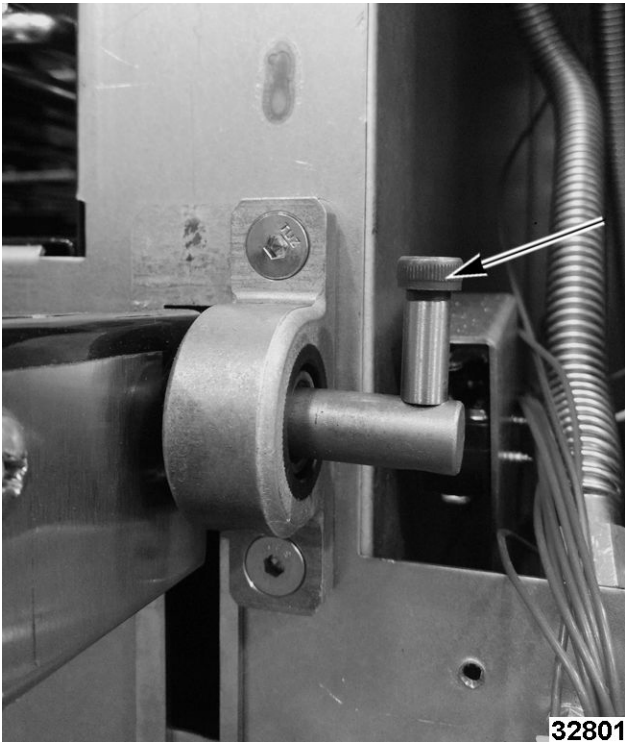


Fig. 94

**OVEN DOOR MICROSWITCH (C MODEL)**



**WARNING**

Disconnect the electrical power to the machine and follow lockout / tagout procedures.

1. Disconnect supply power.
2. Remove OVEN CONTROL PANEL COVER.
3. Remove top two screws on switch mounting bracket and pull switch out of unit.

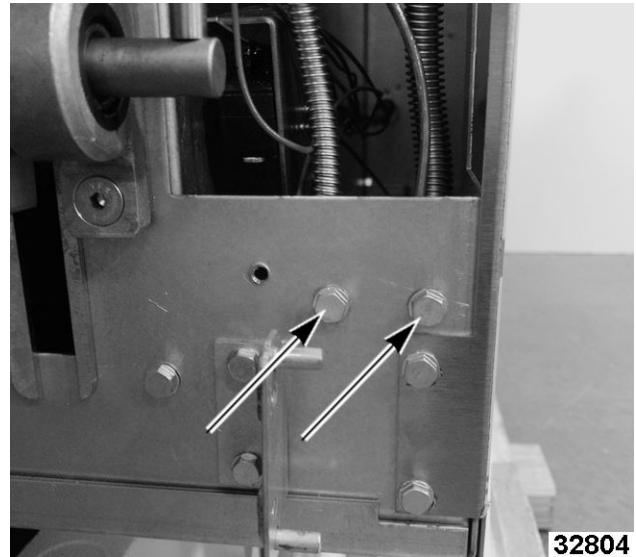


Fig. 95

4. Note and disconnect microswitch (1, Fig. 96) wiring.

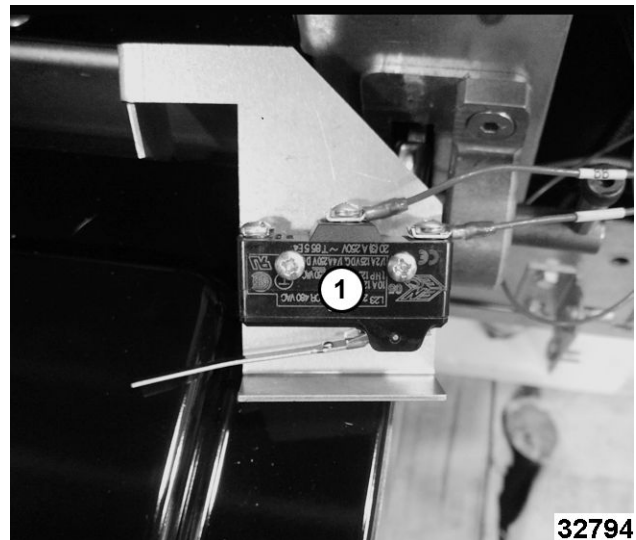


Fig. 96

5. Remove microswitch from mounting screws.
6. Reverse procedure to install.

**NOTICE**

Be cautious not to pinch wiring during installation.

7. Verify proper oven operation.



## GRIDDLE THERMOSTAT-COMBO VALVE



**⚠ WARNING**

Disconnect the electrical power to the machine and follow lockout / tagout procedures.



**⚠ WARNING**

Shut off the gas before servicing the unit and follow lockout / tagout procedures.

**⚠ WARNING**

All gas joints disturbed during servicing must be checked for leaks. Check with a soap and water solution (bubbles). Do not use an open flame.

1. Remove BULL NOSE.
2. Raise griddle plate from the front and support with wood blocks.



Fig. 97

3. Locate grooves and bulb shields on the bottom of the plate. Remove screws near front of bulb shield.

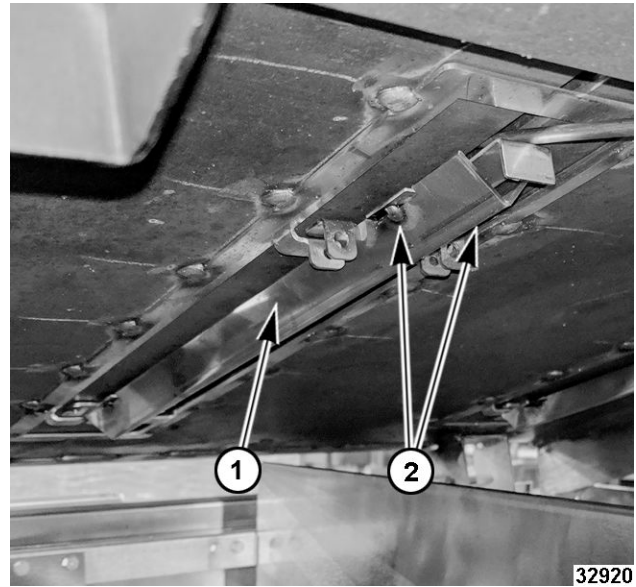


Fig. 98

4. Pull bulb shield forward slightly until front tabs disengage from the plate weldment. Drop bulb shield down in the front, keeping the rear tabs seated in weldment.
5. Remove MANIFOLD COVER.

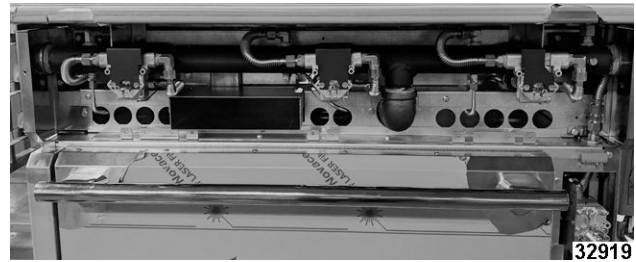


Fig. 99

6. Loosen inlet (1, Fig. 100) and outlet (2, Fig. 100) compression nuts.

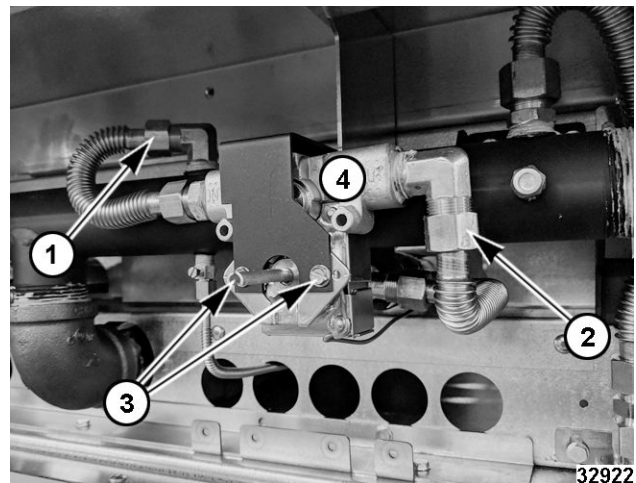


Fig. 100

7. Remove mounting screw (3, Fig. 100).

8. Remove thermostat body and capillary tube assembly (4, Fig. 100).

**NOTE:** Observe routing for installation purposes.

9. Mount new thermostat onto manifold and make all gas connections. Uncoil the bulb and capillary and feed through opening in unit front frame.

### NOTICE

Ensure that installation is leak free.

10. Place bulb into groove on bottom of plate. Ensure that bulb is inserted all the way into groove so that tip is touching the back end. Gently use the capillary to press bulb up into groove so that it rests flat against the top.



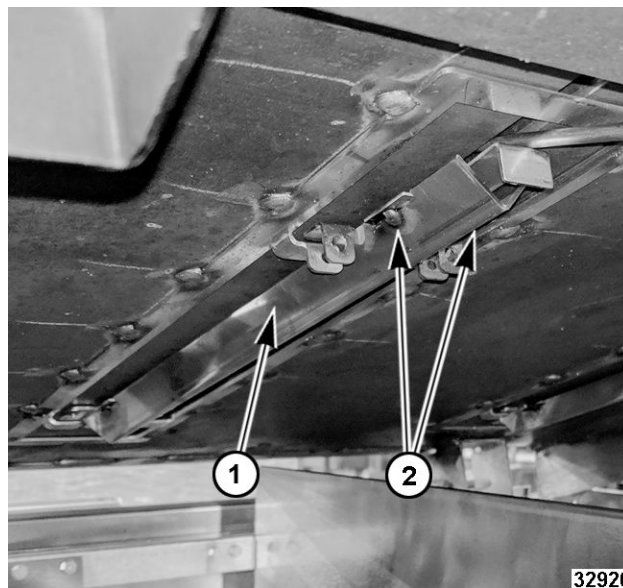
**Fig. 101**

11. While still holding the bulb against the top and end of the groove using the capillary, lift the bulb shield up and slot back into place.

### NOTICE

Spring clips should firmly press bulb up against the plate when shield is in place. If bulb slips off of spring clips or is not sitting flat against plate, lower shield and reseal bulb properly. Failure to seat bulb firmly against the top of the groove will result in thermostat not sensing temperature properly and the griddle will not heat properly.

12. Verify bulb is seated properly and shield (1, Fig. 102) is back in place, fasten tight with two screws (2, Fig. 102).



**Fig. 102**

13. Coil all excess capillary up in space between front frame and burner heat shield.

### NOTICE

Only the length of capillary needed to reach from here to the bulb should be outside of this space. Excess capillary left outside of this space, either inside burner chamber or in manifold area around the thermostat, will be exposed to unwanted heat (from either griddle burner or range oven) and will give false readings to thermostat and cause poor heating.

14. Carefully lower griddle plate back into place.
15. Replace manifold cover and bullnose.

### WARNING

**All gas joints disturbed during servicing must be checked for leaks. Check with a soap and water solution (bubbles). Do not use an open flame.**

### WARNING

**Clean pipe threads and apply thread sealant that is suitable for use with propane gases.**

16. Perform TEMPERATURE CONTROL CALIBRATION.
17. Check for proper operation.

## GRIDDLE PILOT ASSEMBLY



### ⚠ WARNING

Disconnect the electrical power to the machine and follow lockout / tagout procedures.



### ⚠ WARNING

Shut off the gas before servicing the unit and follow lockout / tagout procedures.

1. Raise griddle plate from the front and support with wood blocks.



Fig. 103

2. Remove MANIFOLD COVER.
3. Disconnect pilot flex tube (1, Fig. 104).

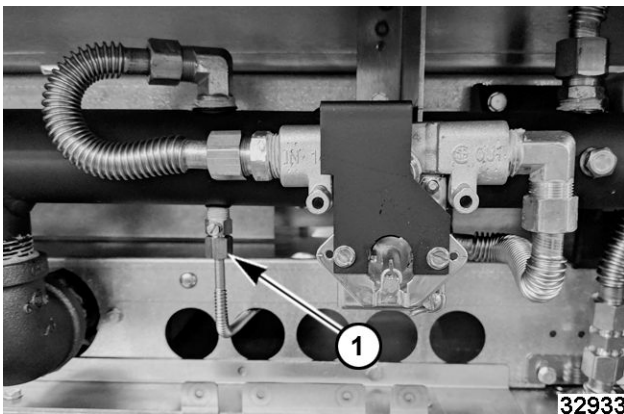


Fig. 104

4. Remove pilot (1, Fig. 105) from clip on burner.

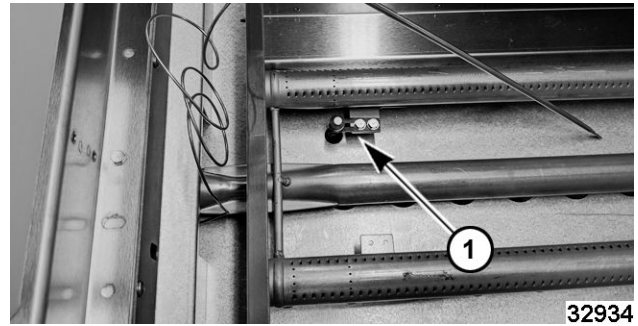


Fig. 105

### ⚠ WARNING

All gas joints disturbed during servicing must be checked for leaks. Check with a soap and water solution (bubbles). Do not use an open flame.

### ⚠ WARNING

Clean pipe threads and apply thread sealant that is suitable for use with propane gases.

5. Reverse procedure to install.
6. Verify proper operation.

## GRIDDLE BURNER ORIFICE



### ⚠ WARNING

Shut off the gas before servicing the unit and follow lockout / tagout procedures.

1. Remove MANIFOLD COVER.
2. Disconnect elbow to access burner orifice.



Fig. 106

3. Remove orifice.
4. Reverse procedure to install and check for proper operation.

**⚠ WARNING**

Clean pipe threads and apply thread sealant that is suitable for use with propane gases.

**⚠ WARNING**

All gas joints disturbed during servicing must be checked for leaks. Check with a soap and water solution (bubbles). Do not use an open flame.

**NOTE:** When installing, ensure orifice hood is aligned and centered in the burner assembly opening.

# SERVICE PROCEDURES AND ADJUSTMENTS

## GAS LEAK CHECK

### ⚠ WARNING

All gas joints disturbed during servicing must be checked for leaks. Check with a soap and water solution (bubbles). Do not use an open flame.

After completing service on any gas equipment, all gas joints disturbed during service must be checked for leaks. DO NOT USE AN OPEN FLAME. Use a hazardous gas tester or use a soap and water solution as follows:

1. Apply a soap and water solution to gas joint and check for bubbles.
2. If bubbles are present, the joint is leaking and must be repaired before using equipment.

## GAS PRESSURE CHECK



### ⚠ WARNING

Disconnect the electrical power to the machine and follow lockout / tagout procedures.

1. Remove MANIFOLD COVER.
2. Turn off gas supply.
3. Remove one plug from gas manifold.

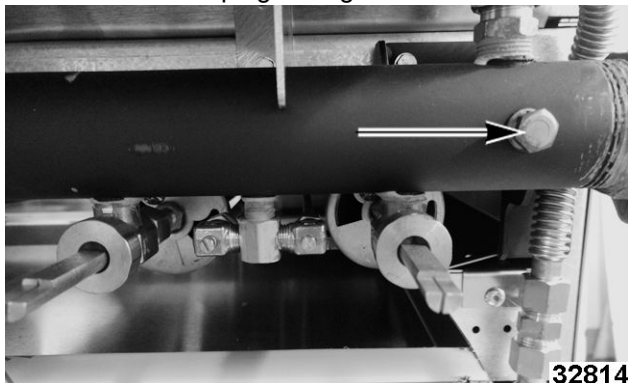


Fig. 107

4. Connect manometer to gas manifold.
5. Turn on gas supply.
6. Check manometer reading.

#### Reading should be...

- 6.0" W.C. for Natural Gas.
- 11.0" W.C. for Propane Gas.

**NOTE:** In a battery arrangement, connect manometer to center unit of the battery.

**NOTE:** If pressure reading is taken at the oven burner or anywhere other than the main gas manifold pipe, pressure reading will not be valid.

### ⚠ WARNING

All gas joints disturbed during servicing must be checked for leaks. Check with a soap and water solution (bubbles). Do not use an open flame.

7. Perform either:
  - If pressure is correct, no adjustment is necessary. Remove manometer and replace manifold cover.
  - If pressure is NOT correct, perform GAS PRESSURE REGULATOR ADJUSTMENT (OPTIONAL).

## GAS PRESSURE REGULATOR ADJUSTMENT (OPTIONAL)



### ⚠ WARNING

Disconnect the electrical power to the machine and follow lockout / tagout procedures.

1. Check incoming gas line pressure. Refer to: GAS PRESSURE CHECK and leave manometer installed.
2. Remove regulator closing nut.
3. Turn adjusting screw with flat-edge screwdriver to adjust.
  - Clockwise to Increase Pressure.
  - Counterclockwise to Decrease Pressure.
4. Turn adjusting screw as needed for proper regulator outlet pressure.
  - 6.0" W.C. for Natural Gas.
  - 10.0" W. C. for Propane Gas.
5. Check for insufficient gas volume:
  - A. Fire up one burner and take a reading, then fire up all burners on the range and take a reading.
  - B. Fire up all gas appliances on that supply line and take a reading.

**NOTICE**

At no time should the pressure drop more than ½" W.C.

- C. If pressure drop is greater than ½" W.C., go to the next step.
- D. Turn off all gas valves. Adjust regulator to no more than ½" W.C. above specifications, which would be 6.5" W.C. for natural gas or 10.5" W.C. for propane.
- E. Repeat Step 1 and Step 2.
- F. If pressure drop is still greater than ½" W.C., there may be a lack of volume due to too small of a supply line. Check with gas provider about installing a larger size gas line.

**⚠ WARNING**

All gas joints disturbed during servicing must be checked for leaks. Check with a soap and water solution (bubbles). Do not use an open flame.

- 6. Install regulator closing nut.
- 7. Remove manometer and reinstall plug.

**OVEN PILOT FLAME CHECK AND ADJUSTMENT**

- 1. Verify pilot flame is:
  - A. Large enough to completely engulf the tip of the thermocouple/sensor and make the tip of thermocouple/sensor red hot.
  - B. A sharp, well-defined two-tone blue flame when burning natural gas.

**NOTICE**

When burning propane (LP) there may be a tiny yellow tip to the flame. This yellow tip should not be more than 10% of the total flame size.

- 2. Remove OVEN CONTROL PANEL COVER.
- 3. Locate pilot adjustment screw.

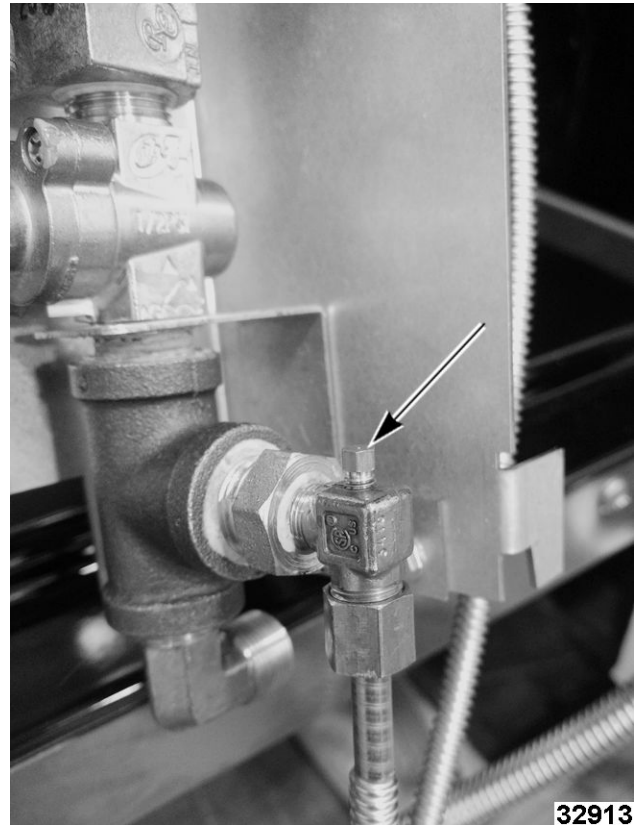


Fig. 108

32913

- 4. Rotate adjustment screw.
  - Clockwise to Decrease Flame Height
  - Counterclockwise to Increase Flame Height
- 5. Install OVEN CONTROL PANEL COVER.

**TOP BURNER PILOT**

- 1. Verify pilot flame is:
  - A. Large enough to completely engulf the tip of the thermocouple/sensor and make the tip of thermocouple/sensor red hot.
  - B. A sharp, well-defined two-tone blue flame when burning natural gas.

**NOTICE**

When burning propane (LP) there may be a tiny yellow tip to the flame. This yellow tip should not be more than 10% of the total flame size.

- 2. Remove MANIFOLD COVER.
- 3. Locate pilot adjustment screw (1-Rear, 2-Front, Fig. 109).

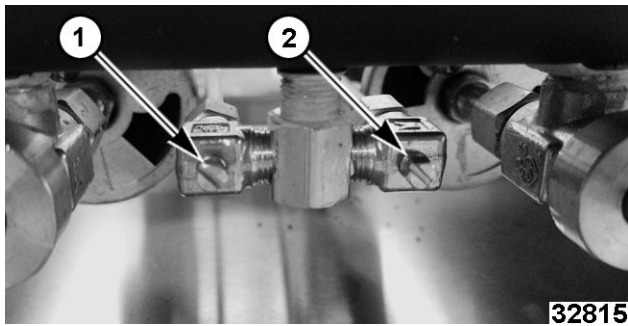


Fig. 109

4. Rotate adjustment screw.
  - Clockwise to Decrease Flame Height.
  - Counterclockwise to Increase Flame Height.
5. Install MANIFOLD COVER.

## OVEN BURNER NOZZLE AND GAS ORIFICE CHECK

### NOTICE

The oven burner nozzle is mounted between the oven gas manifold and u-burner assembly. If burner operation seems poor and other systems have been checked, remove burner nozzle and check for blockage or damage.



### WARNING

Disconnect the electrical power to the machine and follow lockout / tagout procedures.



### WARNING

Shut off the gas before servicing the unit and follow lockout / tagout procedures.

1. Disconnect supply power and gas.
2. Remove OVEN BURNER NOZZLE AND GAS ORIFICE.
3. Remove burner hood.
4. Check for blockage or damage.

### WARNING

All gas joints disturbed during servicing must be checked for leaks. Check with a soap and water solution (bubbles). Do not use an open flame.

5. Reverse procedure to install.

6. Verify proper oven operation.

## AIR SHUTTER ADJUSTMENT

### NOTICE

Burner efficiency depends on a delicate balance between air supply and the volume of gas. When this balance is disturbed, poor operating characteristics and excessive gas consumption will occur. An air shutter on the front of each burner controls the air-gas mixture. With natural gas, the air shutter will be approximately 50% open. On propane (LP) the air shutter will be approximately 90% open.

**If flame is soft, lazy , or yellow, there is not enough primary air. To correct this condition:**

1. Rotate air shutter open until burner flame begins to lift from the burner, then close shutter slightly.
2. If this does not solve the problem, check burner for obstructions and clear as necessary.

**If flame is lifting off burner there is too much primary air.**

1. Close air shutter slightly.
2. Retest.

**NOTE:** If grates, hot tops or oven bottoms have been removed, recheck flame adjustments with these items in place.

### NOTICE

If burner operation still seems poor and other systems have been checked, refer to: OVEN BURNER NOZZLE AND GAS ORIFICE CHECK.

## TOP BURNER ADJUSTMENT

1. Remove MANIFOLD COVER.
2. Loosen screw on air shutter. Fig. 110

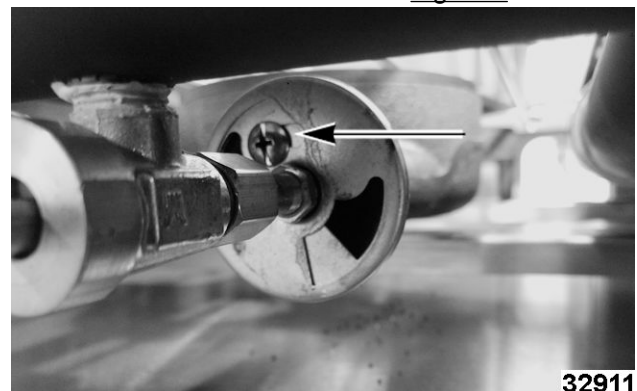


Fig. 110

Standard Models Fig. 111



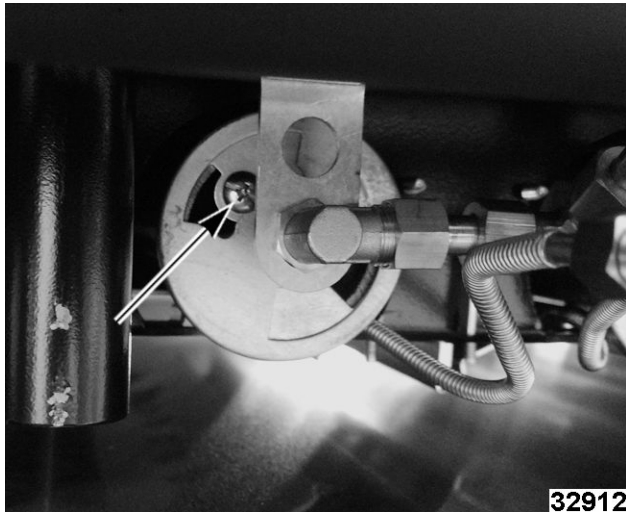


Fig. 111

3. Light burners and observe quality of the flame.
4. Adjust air shutter. Refer to: AIR SHUTTER ADJUSTMENT.
5. Repeat Step 2 through Step 4 for all remaining burners.
6. Tighten screw for air shutter.
7. Replace MANIFOLD COVER.
8. Verify proper oven operation.

## OVEN BURNER ADJUSTMENT

1. Remove KICK PANEL.
2. Remove food deflector.



Fig. 112

3. Remove screw securing burner drawer box to oven.

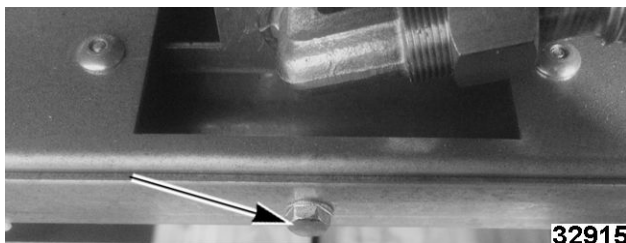


Fig. 113

4. Light the oven and observe quality of the flame.
5. Adjust burner.
  - Rotate Burner Hood Clockwise to Decrease Air.
  - Rotate Burner Hood Counterclockwise to Increase Air.
6. Tighten screw on burner hood.
7. Replace kick panel.
8. Verify proper oven operation.

## OVEN DOOR MICROSWITCH TEST (C MODEL)



### WARNING

**Disconnect the electrical power to the machine and follow lockout / tagout procedures.**

**NOTE:** Oven door microswitch lever should be depressed when oven door is closed.

1. Verify pin attached to oven door hinge contacts the oven door microswitch lever when oven door is closed. An audible click should be heard when microswitch lever is depressed and the microswitch contacts close.
2. Remove OVEN DOOR MICROSWITCH.
3. Use a VOM to perform a continuity test on microswitch.
4. The rear contact on bottom of microswitch is the COMMON connector. The other two connectors are the NORM CLOSED and NORM OPEN connectors.
5. Check continuity between rear (COMMON) connector and one of the two other contacts. If it is open, (no continuity) depressing switch lever should close the connection. If it is closed (continuity) depressing the switch should cause the connection to open.
6. Repeat this procedure for the other microswitch contact.
7. If either contact fails to switch from open to closed (normally open contact) or fails to switch from closed to open (normally closed contact), replace the microswitch.
8. Install OVEN DOOR MICROSWITCH.
9. Verify proper oven operation.

## FAN CONTROL SWITCH (C MODEL)



### **WARNING**

Disconnect the electrical power to the machine and follow lockout / tagout procedures.

1. Remove OVEN CONTROL PANEL COVER.
2. Use a VOM to perform a continuity test on fan control switch.
3. With fan control switch in OFF position, verify there is no continuity between contacts on either side of the switch.
4. Place fan control switch in ON position. Verify continuity is present between contacts for wires 62 & 13 and wires 63 & 64. Verify there is no continuity between wires 63 & 61.
5. Place fan control switch in the COOL DOWN position. Verify continuity is present between contacts for wires 63 & 61. Verify there is no continuity between wires 62 & 13 and wires 63 & 64.
6. If fan control switch fails any continuity tests, replace FAN CONTROL SWITCH.
7. Verify proper oven operation.

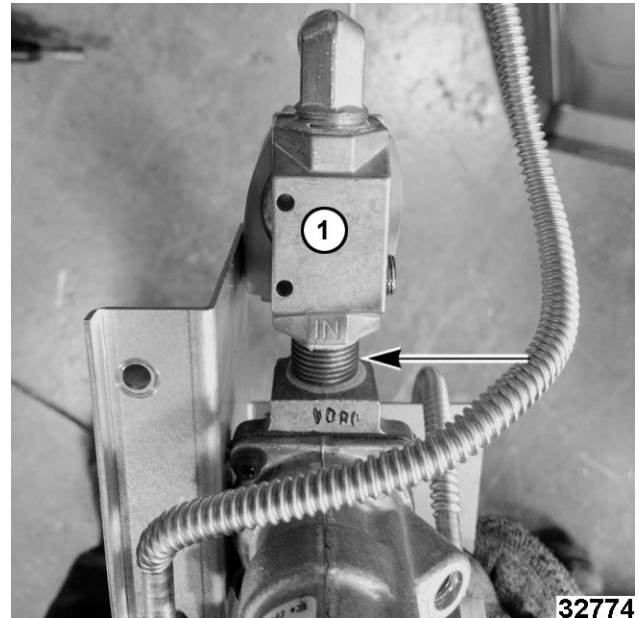


Fig. 114

**CURRENT PRODUCTION**

## SOLENOID TEST (C MODEL)



### **WARNING**

Disconnect the electrical power to the machine and follow lockout / tagout procedures.

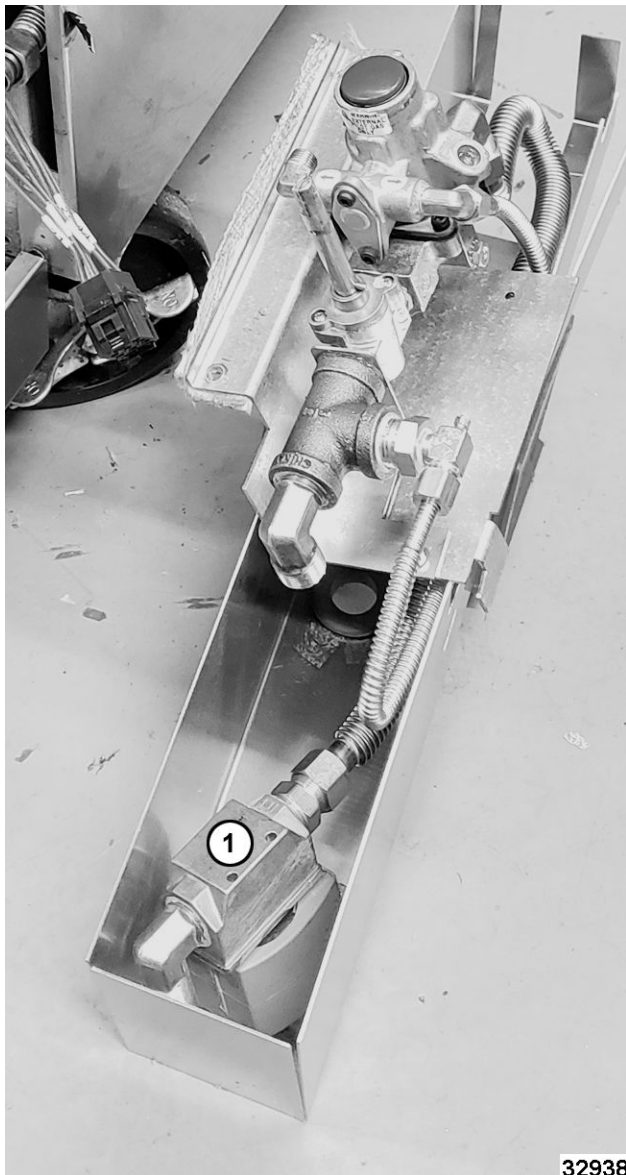


### **WARNING**

Shut off the gas before servicing the unit and follow lockout / tagout procedures.

1. Remove OVEN CONTROL PANEL COVER.
2. Locate solenoid (1, PREVIOUS PRODUCTION - CURRENT PRODUCTION).

**PREVIOUS PRODUCTION**



32938

Fig. 115

3. Place fan control switch in the ON position. An audible click should occur when the switch is activated. If the solenoid does not cycle, check for proper voltage and ground at the solenoid as follows:
  - A. Place a multi meter in appropriate AC range (220 volts AC or 120 volts AC). Check for voltage at solenoid. If voltage is not available, shut off electrical power to oven and check continuity between the power switch and solenoid.
  - B. If voltage is available, shut off electrical power to the oven. Place multi meter in continuity range. Check for continuity between the solenoid ground connection and a ground. If continuity is not available, check and repair ground connections.

- C. If continuity is available, remove SOLENOID and check for solenoid orifice obstruction.

**⚠ WARNING**

**All gas joints disturbed during servicing must be checked for leaks. Check with a soap and water solution (bubbles). Do not use an open flame.**

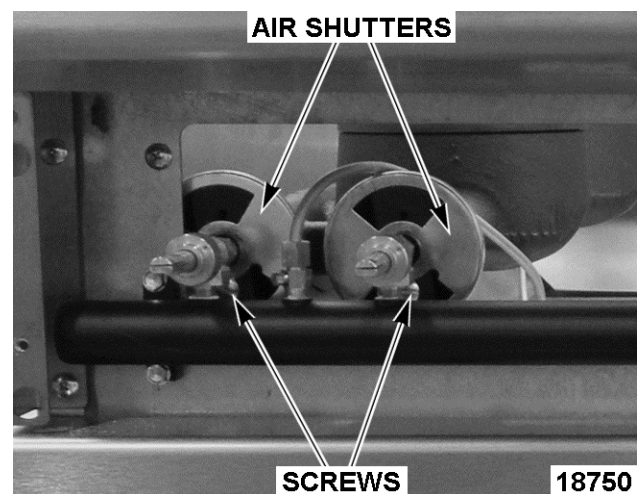
4. Reverse procedure to install solenoid.
5. Verify proper oven operation.

**BURNER AIR SHUTTER ADJUSTMENT**

The efficiency of the burner depends on a delicate balance between the air supply and volume of gas. Whenever this balance is disturbed, poor operating characteristics and excessive gas consumption may occur. An air shutter on the front of the burner controls the gas mixer balance. A yellow streaming flame on the burner is an indication of insufficient primary air.

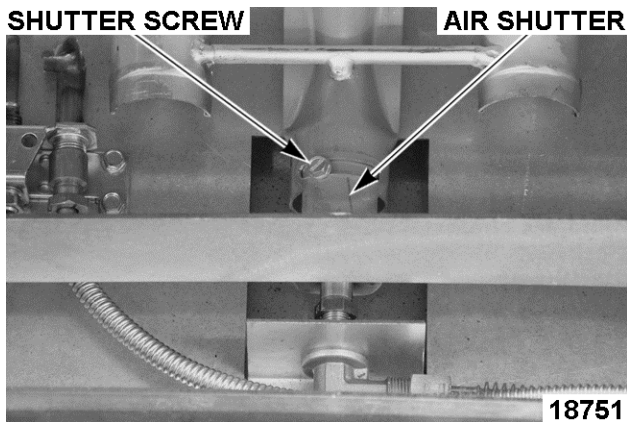
To correct this condition, loosen the shutter screw and rotate the air shutter open until the flame begins to lift from the burner, then close the shutter slightly and tighten the shutter screw. A proper flame should be blue in color, well-defined and seated on the burner port. A white-blue flame is a result of excessive primary air.

**NOTE:** The factory default air shutter positions are half open natural; full open propane.

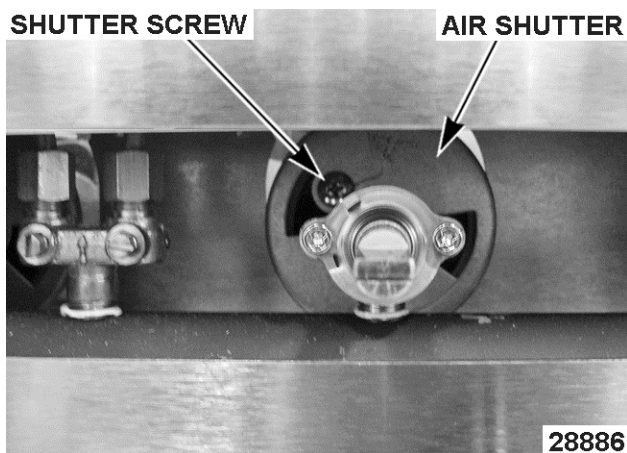


18750

Top Burner Air Shutters



Oven Burner Air Shutter



Charbroiler Burner Air Shutter

## CHARBROILER PILOT ADJUSTMENT

### Pilot Adjustment

- Turn pilot adjustment screw clockwise to decrease the flame.
- Turn pilot adjustment screw counter-clockwise to increase the flame.
- Pilot is in adjustment when it will stay on continually and lights the burner without delayed ignition.

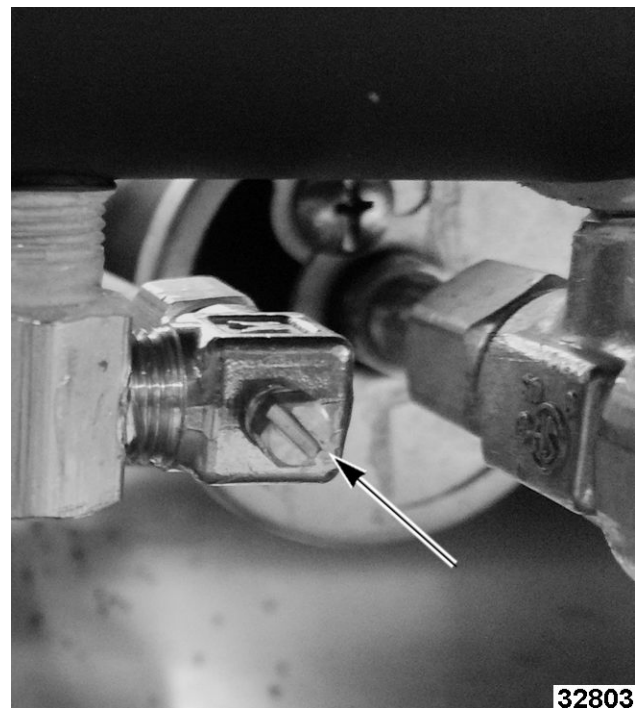


Fig. 119

## GRIDDLE THERMOSTAT-COMBO VALVE CALIBRATION

### Operation

The thermostat-combo valve is self-regulating and the thermostat is internally connected to the valve. When thermostat dial is set to 350°F and the griddle is below setpoint, the valve opens to allow gas flow and burner lights. As the griddle temperature rises, the pressure from the sensor bulb secured to the bottom of the griddle plate increases. Fluid in the capillary tube expands with the temperature increase and presses against a diaphragm in the thermostat. When the griddle temperature reaches setpoint, the internal valve closes to stop gas flow to burner.

When the griddle temperature decreases below setpoint, the pressure is reduced in the capillary which reduces the force on the diaphragm allowing the valve to open again.

### Calibration

1. Clean temperature test area on griddle zone surface. Apply a small amount of clean cooking oil to the test area to ensure good surface probe contact.
2. Place a thermocouple surface probe in center of griddle zone to verify actual temperatures throughout adjustment. See TOOLS for thermocouple type. See table for proper testing locations according to griddle size.

**NOTE:** This procedure will need to be performed for each testing location on all griddle zones.

Griddle Size	Distance(s) From Left Edge of Griddle
12"	6"
24"	6", 18"
36"	6", 18", 30"

**NOTE:** All readings taken 12" from front of griddle.

3. Turn thermostat knob to 350°F and allow griddle to cycle 3 complete times.
  - A. If the customer has a preferred temperature setting that they always operate the oven at such as 325°, 375° or 400°, you may calibrate to that temperature instead.

**NOTE:** Most calibrations are made at 350°F. Thermostat tolerance will increase at higher temperature settings.

4. Observe burner flame. Note temperature tester reading when burner turns ON and OFF.
5. Add these two temperatures together, then divide the sum by 2 to obtain an average temperature. If the average temperature is more than ±25° from knob setting, calibrate as follows:
  - A. Pull off knob.

**NOTE: Do not rotate knob during removal.**

**NOTICE**

Do not turn the adjustment screw more than 3/8 turn or damage to the thermostat may occur.

- B. While holding outer shaft in place, turn inner screw using a small flat edge screwdriver 1/8 turn clockwise to decrease and counterclockwise to increase. 1/4 turn = 35°F.

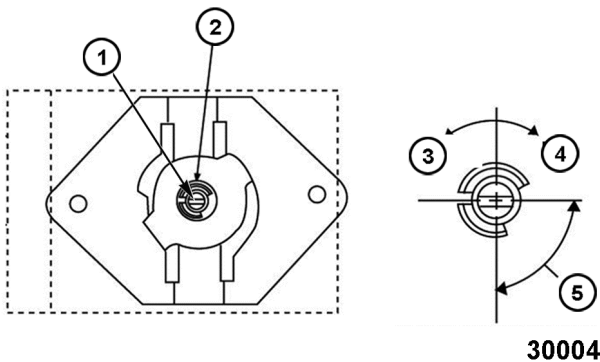


Fig. 120

FRONT OF THERMOSTAT SHOWN IN Fig. 120	
Item	Description
1	Inner screw for temperature adjustment.
2	Outer Shaft.
3	Direction to increase temperature.
4	Direction to decrease temperature.
5	1/4 turn equals 35°F.

- C. Verify temperature setting at 350°F (or customers preferred setting). Allow griddle to cycle 3 times.

**NOTE:** You must allow the griddle to cycle 3 times to stabilize oven temperature or the calibration adjustment may be invalid. **DO NOT TURN KNOB.**

- D. Take a temperature reading. If temperature is within acceptable limits, continue to next step. If temperature is not within ±25°F then readjust as outlined in this procedure. If 3 consecutive adjustments do not produce acceptable results, replace thermostat and verify calibration.
- E. Apply a small amount of a non permanent type sealer (preferably fast drying) such as nail polish or equivalent around the inner screw head to prevent movement during outer shaft rotation. Allow sufficient time for the applied sealer to dry then install knob. See TOOLS.
- F. If calibrating at 350°F, verify temperature at 400°F. If calibrating at a customer preferred temperature setting, select one temperature setting above the customer preferred setting. If the customers temperature setting is 450°F, then calibrate at that temp only. Allow oven to cycle 3 times at the temperature setting. If actual oven temperature is not within ±25°F of the setting, replace thermostat and verify calibration.

**BY-PASS FLAME ADJUSTMENT**

**NOTE:** This adjustment must be made with the burner pilot flame ignited.

1. Turn on oven valve.
2. Turn the thermostat dial to 200°F to ignite main burner.

3. With oven cool, turn dial counterclockwise slowly from "LOW STOP", until by-pass seat just snaps on.
4. Remove thermostat dial.
5. With a screwdriver, turn by-pass flame adjustment screw (1, Fig. 121) counterclockwise to increase by-pass flame or clockwise to decrease flame until the entire burner has 1/8" min. to 1/4" max. stable flame on each port.

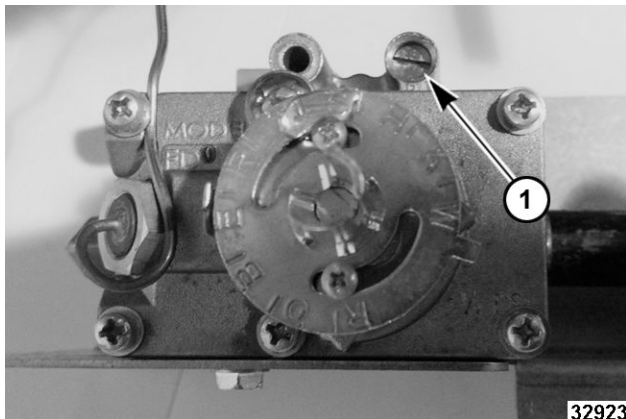


Fig. 121

6. Replace thermostat dial.

**NOTE:** While making adjustment, if oven becomes heated while dial is set at low range (below 350°), the by-pass flame will shut off completely. If this occurs, turn dial counterclockwise slowly until by-pass gas snaps on. Then check by-pass adjustment as stated above.

## TEMPERATURE CONTROL CALIBRATION

**NOTE:** Field CALIBRATION is seldom necessary and should not be resorted to unless experience with cooking results definitely proves that the control is not maintaining set temperature. To check oven temperatures when calibrating, use a Robertshaw Test Instrument or a reliable mercury oven thermometer.

### Standard Oven

1. Place thermocouple of test instrument or thermometer in middle of the oven. Close oven door.
2. Light main burner.
3. Turn dial to any temperature setting and allow oven to heat until flame cuts down to bypass. Let cycle several times.

4. After burner has been on sufficiently long enough to cut down the bypass flame, check oven temperature. Calibrate the control if your reading is not within 15°F of the dial setting.

**If CALIBRATION is required, proceed as follows:**

- A. Remove knob (1, Fig. 122).



Fig. 122

- B. Loosen both calibration screws (1, Fig. 123) until calibration plate moves independently of the control.

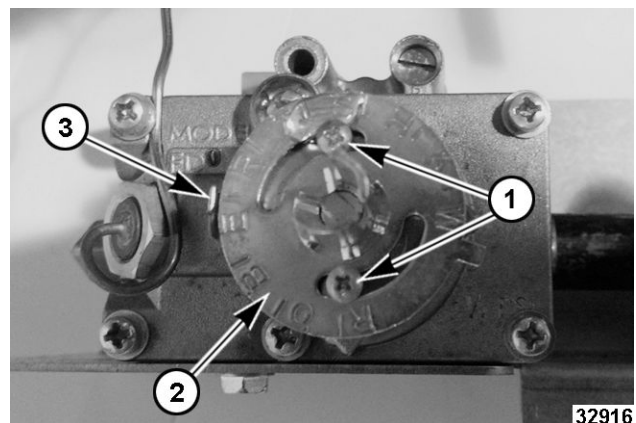


Fig. 123

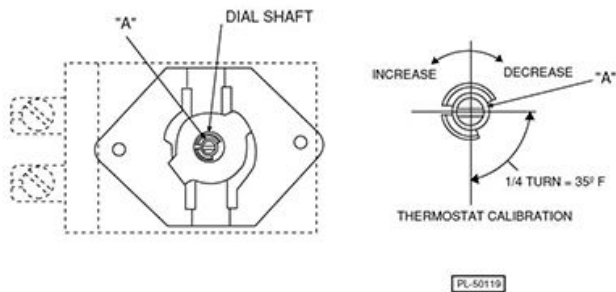
- C. Turn calibration plate (2, Fig. 123) until mark corresponding to test instrument or thermometer reading is in line with center of pointer "A" (3, Fig. 123), and while holding in this position, tighten calibration screws firmly.
- D. Replace knob.

**NOTE:** If above adjustment is prevented by the loosened calibration screws being in contact with the

ends of the screw clearance slots in the calibration plate, remove screws, and after turning the calibration plate to proper location, reassemble screws in the other tapped holes designed for them.

**Convection Oven**

1. Place thermocouple of test instrument in middle of oven. Close oven door.
2. Light main burner by turning thermostat dial to any temperature setting.
3. Allow oven to heat until flame cuts off. After several cycles, check temperature. If temperature does not read within 15°F of the dial setting, calibrate as follows:
4. Pull dial straight off dial shaft without turning (Fig. 124).



**Fig. 124**

5. Turn screw "A" clockwise to decrease temperature and counterclockwise to increase temperature (Fig. 124); 1/4 turn of Screw "A" represents a temperature shift of 35°F.

**THERMOCOUPLE TEST**

**Operation**

The thermocouple supplies a DC millivolt signal (MV) to gas safety valve when heated by pilot flame. The gas safety valve will shut off gas flow to pilot and main burner in case of a pilot outage. When energized by thermocouple voltage, the gas safety valve is held open to permit gas flow to pilot and provide gas for burner when thermostat calls for heat. Height of pilot flame is controlled by an adjustable needle valve located under a small cover screw on the gas safety valve.

**Pilot Checks**

If experiencing pilot outages, perform the following:

Visually check pilot flame for the proper contact on thermocouple and adjust pilot assembly . If adjustment does not result in a pilot flame of proper height, then gas might not be flowing properly to the pilot.

Check for:

- A plugged pilot orifice.
- Kinked or plugged pilot gas tubing.
- Low gas supply pressure.

**Thermocouple Checks**

**NOTE:** Tubing connection from the thermocouple tip to gas safety valve is an electrical connection and must be clean and dry. Do not use any sealing compound on the threads of thermocouple nut.

**NOTICE**

Do not overtighten the thermocouple nut or the insulator could be crushed, shorting the thermocouple. Finger tighten the nut plus 1/4 turn with a wrench only.

If pilot flame is correct and there are no excessive air drafts in the room, then problem is either the thermocouple output voltage or the gas safety valve.

Visually check the thermocouple tip (hot end) and tube lead for:

- Loose thermocouple connection (electrical) at the safety valve.
- Corrosion or debris on the threaded connector or thermocouple tip causing a poor electrical connection.
- Kinks or pinches that might cause a short between the tube and the wire inside.

If thermocouple is loose, tighten mounting nut.

**NOTICE**

Do not overtighten the thermocouple nut or the insulator could be crushed, shorting the thermocouple. Finger tighten the nut plus 1/4 turn with a wrench only.

If thermocouple connection shows signs of corrosion or debris that cannot be cleaned; or damage as described, replace it and check pilot operation. Refer to pilot assembly.

**Thermocouple Test**

Check the thermocouple output voltage (DC millivolts) with a VOM as outlined in the steps below.

- If thermocouple adaptor (see Tools) is available, check *closed* circuit voltage as outlined in the test procedure.
- If thermocouple adaptor is not available, check *open* circuit voltage as outlined in the test procedure.



- If a VOM is not available, replace the thermocouple with a new one as outlined under the appropriate procedure below and check operation. Refer to Pilot assembly.
- 1. Disconnect thermocouple from gas safety valve.
- 2. Select the test to perform.
- 3. **Closed Circuit.**
  - A. Install thermocouple adaptor at the threaded connection on gas safety valve.
  - B. Install thermocouple to the adaptor.

**NOTICE**

Do not overtighten the thermocouple nut or the insulator could be crushed, shorting the thermocouple. Finger tighten the nut plus 1/4 turn with a wrench only.

- C. Light the pilot. Allow pilot to heat thermocouple for one to two minutes.
  - D. Connect one meter lead to the adaptor test point and the other meter lead to the tube. Compare reading to the value listed in the table below.
- 4. **Open Circuit.**
  - A. Connect one meter lead to the tip of the threaded end and the other meter lead to the tube. Compare reading to the values listed in the table below.
  - B. Light the pilot and continue to hold down the pilot gas button on the safety valve during this test. Allow pilot to heat thermocouple for one to two minutes.
  - C. Compare reading to the value listed in the table below.

<b>THERMOCOUPLE MV READINGS</b>	
	<b>Open Circuit</b>
Range	25 to 35 MV

- 5. If readings are less than the minimum stated above, replace the thermocouple as outlined under the appropriate procedure below and check for proper operation.  
  
If a VOM is not available, replace the thermocouple with a new one as outlined under the appropriate procedure below and check operation.
- 6. Check for proper operation.

# ELECTRICAL OPERATION

## COMPONENT FUNCTION

<b>Power Cord</b> .....	A three-prong grounding plug that connects the oven to the electrical power source. The oven will not operate unless it is connected to an electrical power supply.
<b>Convection Oven Solenoid</b> .....	The solenoid is a normally closed switch that opens and closes the gas valve. When the electrical circuit is completed through the solenoids coil, a magnetic field is created, drawing on a spring-loaded plunger which opens the gas valve.
<b>Oven Door Microswitch</b> .....	Oven Door Microswitch The oven door microswitch is located behind the control panel. When the oven door opens, the door switch opens the circuit to the pilot solenoid and convection fan motor.  <b>NOTE:</b> When the fan control switch is placed in the COOL DOWN position, the oven door microswitch is bypassed to allow the convection fan to run while the oven door is opened.
<b>Fan Control Switch</b> ...	The manually operated, 3-position fan control switch controls the convection motor. The switch is located on the control panel. When the fan control switch is placed in the ON position, the convection fan will come on when the oven door microswitch contacts are closed. When the fan switch is placed in the COOL DOWN position, the door switch is bypassed to allow the fan to run while the oven door is open to rapidly lower the oven temperature. When the fan switch is placed in the OFF position, the convection motor contacts are open preventing the fan from operating.
<b>Junction Box</b> .....	A junction box attached to the back of the oven is the connection point for the oven electrical wires.
<b>Convection Oven Motor</b> .....	The single-phase convection oven motor rotates a rotor blower that circulates oven-heated air. An internal centrifugal switch will close when the motor begins to rotate to complete the electrical circuit. The convection motor should operate when the door is closed and the fan control switch is placed in the ON position. The convection motor should shut off when the oven door is opened unless the fan control switch is placed to the COOL DOWN position. In the COOL DOWN position the oven door microswitch is bypassed so that the convection motor will run while the oven door is open to rapidly lower the oven temperature.
<b>Standard Oven Thermostat</b> .....	Controls temperature in standard oven. Temperature range 150° to 500°, utilizes by-pass flame.
<b>Convection Oven Thermostat</b> .....	Controls temperature in convection oven. Temperature range 150° to 500°.

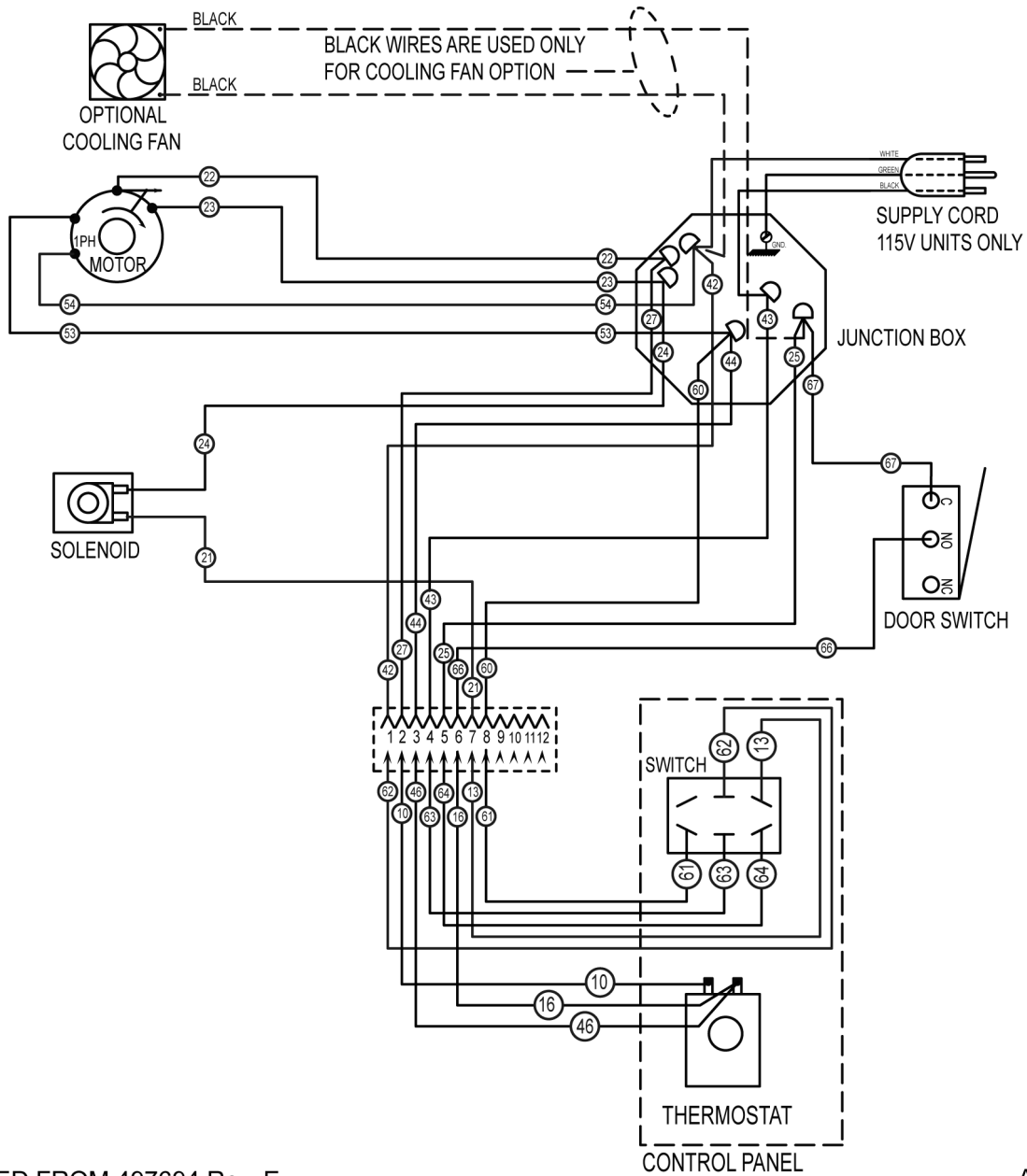
## SEQUENCE OF OPERATION (C MODEL)

Refer to WIRING DIAGRAM.

Initial Conditions

1. Conditions
  - A. The oven has been properly installed and the power plug is plugged into a wall outlet that agrees with the required voltage on the rating plate.
  - B. The oven manual gas shutoff valve is in the OPEN position.
  - C. The oven door is open.
  - D. The oven pilot is lit.
  - E. The temperature control is set to the desired temperature.
2. Turn the fan control switch to ON.
  - A. Power is applied to one side of the convection motor.
  - B. Power is applied to one side of the solenoid.
3. Oven door closed.
  - A. Oven door microswitch contacts will close.
  - B. Power is applied to the other side of the convection motor and it will begin to rotate.
    - 1) The convection motor centrifugal switch will close.
    - 2) Power will flow to the solenoid and the thermostat.
    - 3) The solenoid will open the gas valve and gas will flow to the burner.
    - 4) Oven temperature will be controlled by the oven control valve.
4. Oven door opened.
  - A. With the fan control switch in ON, the oven door microswitch contacts will open and power will be removed from one side of the convection motor.
    - 1) The centrifugal switch will open and power will be removed from the solenoid and the thermostat.
    - 2) The solenoid will close the gas valve and shutoff the gas to the burner.
    - 3) Pilot remains lit.
  - B. With the fan control switch in COOL DOWN, the oven door microswitch is bypassed to the convection motor.
    - 1) The convection motor will continue to run.
    - 2) The oven door microswitch will remove power to one side of the thermostat and the solenoid.
    - 3) The solenoid will close the gas valve and shutoff gas to the burner.
    - 4) Pilot remains lit.
5. Fan control switch to OFF.
  - A. Power is removed from one side of the convection motor.
    - 1) The centrifugal switch will open and power will be removed from the solenoid and the thermostat.
    - 2) The solenoid will close the gas valve and shutoff the gas to the burner.
    - 3) Pilot remains lit.

**WIRING DIAGRAM**



DERIVED FROM 497694 Rev. E

AI4929

**Fig. 125**

# TROUBLESHOOTING

## TROUBLESHOOTING CHART

SYMPTOM	POSSIBLE CAUSES
Pilot does not remain lit.	<ol style="list-style-type: none"> <li>1. Oven front flueing. <u>Diverter (exhaust) baffle</u> is missing.</li> <li>2. Low gas pressure.</li> <li>3. Thermocouple not positioned correctly or malfunctioning.</li> <li>4. Control valve malfunction.</li> </ol>
Burner flame too yellow.	<ol style="list-style-type: none"> <li>1. Orifice incorrect size or obstructed.</li> <li>2. Air Shutter not adjusted correctly.</li> <li>3. Incorrect gas pressure.</li> <li>4. Incorrect gas type.</li> </ol>
<b>CONVECTION OVENS ONLY</b>	
Convection motor does not operate; Burner does not light.	<ol style="list-style-type: none"> <li>1. Main power supply not on.</li> <li>2. Incorrect voltage.</li> <li>3. Oven door switch open or inoperative.</li> <li>4. Fan control switch open or inoperative.</li> </ol>
Convection motor does not operate. Burner lit.	<ol style="list-style-type: none"> <li>1. Convection motor inoperative.</li> </ol>
Convection motor operates but no gas flow to burner. Pilot lit.	<ol style="list-style-type: none"> <li>1. Thermocouple not positioned correctly or malfunctioning.</li> <li>2. Solenoid malfunction.</li> <li>3. Oven control valve malfunction.</li> </ol>
Convection motor noisy.	<ol style="list-style-type: none"> <li>1. Fan mounting loose.</li> <li>2. Blower loose on motor shaft.</li> <li>3. Motor malfunction.</li> </ol>