



# Owner's Manual

FOR THE TURBOCHEF PLEXOR OVEN





For further information, call

800.90TURBO

or

+1 214.379.6000

## Original Instructions

The information contained in this manual is important for the proper installation, use, maintenance, and repair of this oven. Follow these procedures and instructions to help ensure satisfactory baking results and years of trouble-free service.

Errors – descriptive, typographic, or pictorial – are subject to correction. Specifications are subject to change without notice.

Please carefully read this manual and retain it for future reference.

# Table of Contents

<b>Important Safety Instructions</b>	
General Safety Information	i
Reducing Fire Risk	ii
Grounding Instructions	ii
Power Cord Replacement or Removal	ii
Precautions to Avoid Possible Exposure to Excessive Microwave Energy	iii
RF Interference Considerations	iii
Protective Earth (Ground) Symbol	iii
Equipotential Bonding Symbol	iii
<b>Specifications and Installation</b>	
Theory of Operation	1
Features	1
Dimensions	1
Certifications	2
Oven Construction	2
Electrical Specifications	2
Installation	2
Voltage Selection	4
Ventilation	4
<b>Daily Maintenance</b>	5-6
<b>Cooking</b>	
Oven Controls	7
Preset Cooking Instructions	8
<b>Menu Options and Settings</b>	10
<b>Editing Recipes</b>	
Editing Recipe Parameters	11
Editing a Group	13
Editing Cook Settings	13
Oven Module Prioritization	15
<b>USB Operation</b>	16
<b>Troubleshooting</b>	16
<b>Warranties</b>	
North America Limited Warranty	18
International Limited Warranty	20

## IMPORTANT SAFETY INSTRUCTIONS

**⚠** **WARNING:** When operating this oven, strictly adhere to the following safety precautions to reduce the risk of burns, electric shock, fire, injury, damage to oven or property near oven, or possible exposure to excessive microwave energy.

## GENERAL SAFETY INFORMATION

- ✓ Read all instructions before using this appliance.
- ✓ Read and follow the specific “Precautions to Avoid Possible Exposure to Excessive Microwave Energy” found on page ii.
- ✓ This appliance must be grounded. Connect only to a properly grounded outlet. See “Grounding Instructions” on page ii.
- ✓ Install or locate this appliance only in accordance with the provided installation instructions.
- ✓ This appliance should be serviced by qualified service personnel only. Contact the nearest authorized service facility for examination, repair, or adjustment.
- ✓ Keep the cord away from heated surfaces.
- ✓ Liquids, such as water, coffee, or tea are able to be overheated beyond the boiling point without appearing to be boiling. Visible bubbling or boiling when the container is removed from the microwave oven is not always present. **THIS COULD RESULT IN VERY HOT LIQUID SUDDENLY BOILING OVER WHEN THE CONTAINER IS DISTURBED OR A UTENSIL IS INSERTED INTO THE LIQUID.**
- ✓ **WARNING:** The contents of feeding bottles and baby food jars must be stirred or shaken and the temperature checked before consumption, in order to avoid burns (IEC 60335-2-90).
- ✓ Use this appliance only for its intended uses as described in this manual.
- ✓ Only use utensils that are suitable for use in microwave ovens (IEC 60335-2-90).
- x **DO NOT** use corrosive chemicals or vapors in this appliance; it is not designed for industrial/laboratory use.
- x **WARNING: DO NOT** heat liquids or other foods in sealed containers (e.g., jars, whole eggs, etc.) since they are liable to explode.
- x **DO NOT** allow children to use this appliance.
- x **DO NOT** operate this appliance if it has a damaged cord or plug, is not working properly, or has been damaged or dropped. See “Power Cord Replacement or Removal” found on page ii.
- x **DO NOT** cover or block any openings on this appliance.
- x **DO NOT** store this appliance outdoors.
- x **DO NOT** use this product near water (e.g., near a kitchen sink, in a wet basement, near a swimming pool).
- x **DO NOT** immerse the cord or plug in water.
- x **DO NOT** let the cord hang over the edge of a table or counter.
- x **DO NOT** use a water jet for cleaning. See pages 5-6 in this manual for proper cleaning procedures.
- x **WARNING:** Due to the nature of the appliance, the floors around it may be slippery.
- x This appliance is not to be used by children or persons with reduced physical, sensory or mental capabilities, or lack of experience and knowledge, unless they have been given supervision or instruction.

**SAVE THESE INSTRUCTIONS**

## REDUCING FIRE RISK

- ✓ Remove wire twist-ties from paper or plastic bags used to facilitate cooking in the oven.
- ✓ If materials inside the oven ignite, keep the oven door closed, turn the oven off, and disconnect the power cord or shut off power at the fuse or circuit breaker panel.
- ✓ If smoke is observed, switch off or unplug the oven. Keep the door closed to stifle any flames.
- x DO NOT use the cook cavity for storage purposes.
- x DO NOT overcook food. Carefully attend to the oven if paper, plastic, or other combustible materials are placed inside the oven to facilitate cooking.
- x DO NOT leave paper products, cooking utensils, or food in the cavity when the oven is not in use.

## GROUNDING INSTRUCTIONS

This appliance must be grounded. In the event of an electrical short circuit, grounding reduces the risk of electric shock by providing an escape wire for the electric current. This appliance is equipped with a cord having a grounding wire with a grounding plug. The plug must be plugged into an outlet that is properly installed and grounded.

 **WARNING:** Improper use of the grounding can result in a risk of electric shock. Consult a qualified electrician or serviceman if the grounding instructions are not completely understood, or if doubt exists as to whether the appliance is properly grounded, and either:

1. If it is necessary to use an extension cord, use only a 4-wire extension cord that has a 4-blade grounding plug, and a 4-slot receptacle that will accept the plug on the appliance. The marked rating of the extension cord shall be equal to or greater than the electrical rating of the appliance,

– OR –

2. Do not use an extension cord. If the power supply cord is too short, have a qualified electrician or serviceman install an outlet near the appliance.

A commercial microwave oven complying with the Exception No.2 to 38.1, shall have instructions that contain the statement “Warning: Risk of Electric Shock. If the cord or plug becomes damaged, replace only with a cord and plug of the same type”.

 **WARNING:** Improper grounding can result in risk of electric shock.

## POWER CORD REPLACEMENT OR REMOVAL

If the power cord is damaged, it must be replaced by the manufacturer, its service agent, or a similarly qualified person.

 **WARNING:** If the oven is unplugged during service or maintenance, the user must be able to access and see the plug at all times to ensure that the oven remains unplugged. The plug must remain near the oven and cannot be placed behind another appliance or in another room.

## SAVE THESE INSTRUCTIONS

## PRECAUTIONS TO AVOID POSSIBLE EXPOSURE TO EXCESSIVE MICROWAVE ENERGY

- (a) Do not attempt to operate this oven with the door open since open-door operation can result in harmful exposure to microwave energy. It is important not to defeat or tamper with the safety interlocks.
- (b) Do not place any object between the oven front face and the door or allow soil or cleaner residue to accumulate on sealing surfaces.
- (c) Do not operate the oven if it is damaged. It is particularly important that the oven door close properly and that there is no damage to the: (1) Door (bent) (2) Latches (broken or loosened), (3) Door seals and sealing surfaces.
- (d) The oven should not be adjusted or repaired by anyone except properly qualified service personnel.

## RF INTERFERENCE CONSIDERATIONS

This oven generates radio frequency signals. This device has been tested and was determined to be in compliance with applicable portions of FCC part 18 requirements and to the protection requirements of Council Directive 89/336/EEC on the approximation of the laws of the Member States relating to electromagnetic compatibility at the time of manufacture. However, some equipment with sensitivity to signals below these limits may experience interference.

If your equipment experiences interference:

- ✓ Increase the physical separation between this oven and the sensitive equipment.
- ✓ If the sensitive device can be grounded, do so following accepted grounding practices.
- ✓ If battery-powered microphones are being affected, ensure that the batteries are fully charged.
- ✓ Keep sensitive equipment on separate electrical circuits if possible.
- ✓ Route intercom wires, microphone wires, speaker cables, etc. away from the oven.

## PROTECTIVE EARTH (GROUND) SYMBOL



This symbol identifies the terminal which is intended for connecting an external conductor for protection against electric shock in case of a fault, or the terminal of a protective earth (ground) electrode.

## EQUIPOTENTIAL BONDING SYMBOL



This symbol identifies the terminals which, when connected together, bring the various parts of an equipment or of a system to the same potential, not necessarily being the earth (ground) potential, e.g. for local bonding.

**SAVE THESE INSTRUCTIONS**



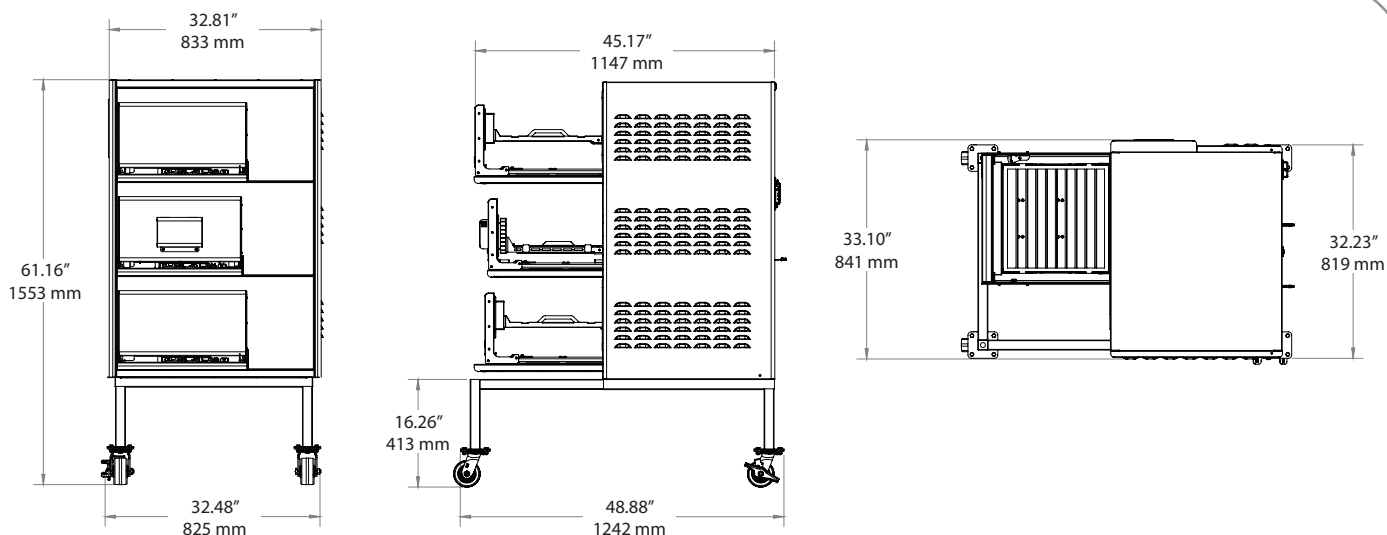

Figure 1: PLEXOR Oven Dimensions

## Theory of Operation

The PLEXOR impingement, rapid cook, and TurboVect modules can be configured in any combination, and can be field retrofitted if menu needs change. What truly sets PLEXOR apart is its modular design and ability to operate three technologies on a single user interface and with a single plug. The PLEXOR features TurboChef's patented ventless technology and can be ordered in left or right automated loading/unloading door orientation to offer additional flexibility.

This manual includes instructions for installing, cleaning, and operating the PLEXOR oven. If you have questions that are not addressed in this manual, contact Customer Support at 800.90TURBO (+1 214.379.6000) or your Authorized Distributor.

## Features

- Autoload/Unload
- Ability to operate each module at different temperatures, if required, allowing product to be cooked at its optimal cooking profile
- Up to 1,000 programmable cooking recipes
- ConnectWare™ ready to connect to Open Kitchen® by Powerhouse Dynamics®
- High-contrast, durable capacitive touch screen

## Dimensions

### Oven Dimensions

Height: 61.16" (1553 mm)  
 Width: 48.88" (1242 mm)  
 Depth: 32.81" (833 mm)

### Oven Weight

Boxed: 670 lb. (304 kg)  
 Oven Only: 610 lb. (277 kg)

### Impingement Cavity Dimensions

Height: 3.4" (86 mm)  
 Width: 16.5" (419 mm)  
 Depth: 16.3" (414 mm)  
 Volume: 0.53 cu.ft. (15.0 liters)

### Rapid Cook Cavity Dimensions

Height: 4.2" (107 mm)  
 Width: 14.0" (356 mm)  
 Depth: 14.0" (356 mm)  
 Volume: 0.48 cu.ft. (13.6 liters)

### TurboVect (Convection) Cavity Dimensions

Height: 3.7" (94 mm)  
 Width: 16.5" (419 mm)  
 Depth: 16.3" (414 mm)  
 Volume: 0.57 cu.ft. (16.1 liters)

### Certifications



cULus, UL EPH,

### Oven Construction

#### Exterior

- 430 stainless steel
- Auto load/unload

#### Interior

- 304 and 430 stainless steel
- Removable jetplates and racks

### Electrical Specifications

#### Multi Phase

US/Canada: 208/240 VAC, 60 Hz, 50 A

Europe/Asia (Delta): 220-240 VAC, 50/60 Hz, 40 A

Europe/Asia (WYE): 380-415 VAC, 50/60 Hz, 20 A

Australia: 380-415 VAC, 50/60 Hz, 20 A

- \* US/Canada models include a voltage sensor that detects 208 or 240 VAC, but does not compensate for lack-of or over-voltage installations.

### Installation

Install or locate this appliance only in accordance with the instructions.

### Unpacking Instructions

1. Remove the oven from its packaging.
2. Before discarding, check the packaging thoroughly for accessories and literature.

NOTE: Packaging may also be retained in case the oven may at some point be shipped somewhere else or returned to the manufacturer.

3. Check the cook cavity thoroughly for accessories and literature.
4. Discard any packaging in the cook cavity.
5. Plug the oven in.

**⚠ WARNING:** The oven must be properly placed on the supplied cart at all times. TurboChef will not recognize a fallen oven as a warrantable claim and is not liable for any injuries that may result.

**⚠ WARNING:** This oven is not intended for built-in installation (i.e., installing the oven in any structure that surrounds the oven by five or more sides).

## Installation Near Open Heat Source

When placing a TurboChef oven near an open heat source (Figure 2), strictly adhere to the following:

- If the oven is being placed near a grill or stove, a divider must exist between the oven and the open heat source, with a minimum of 6" (153 mm) between the oven and the divider.
- If the oven is being placed near a fryer, a divider must exist between the oven and fryer, with a minimum of 12" (305 mm) between the oven and the divider.
- The height of the divider must be greater than or equal to the height of the oven, 61.16" (1553 mm).
- Verify the oven location has a minimum 5" (127 mm) clearance on top and a minimum 2" (51 mm) clearance on each side.

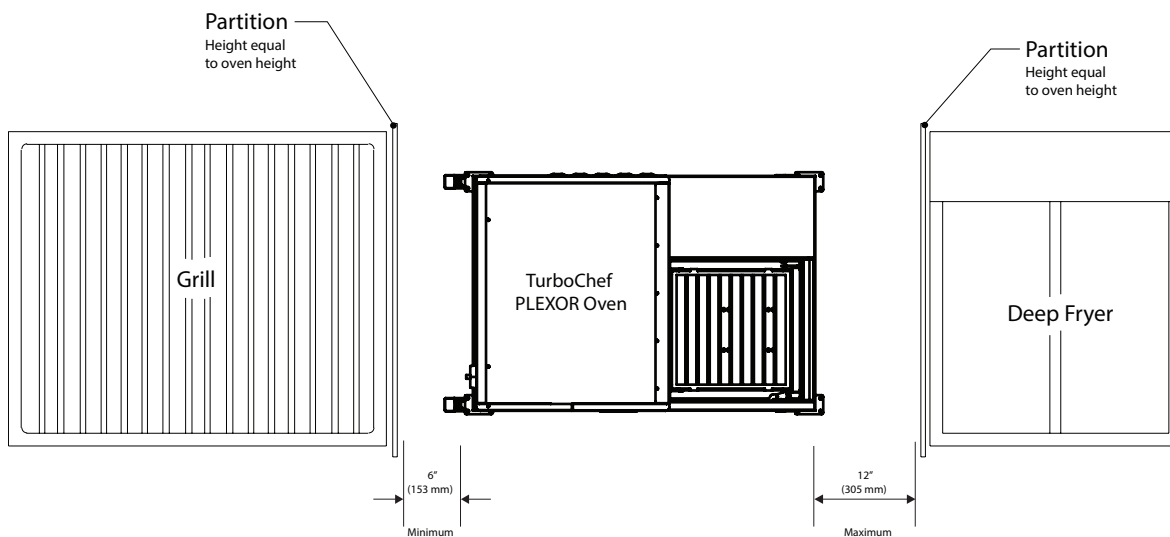

Figure 2: Installation Near Open Heat Source

### Voltage Selection

For North America oven models, the oven will detect 208 or 240 incoming voltage.

If incoming voltage for the store is different than the factory-preset voltage, the operator will be required to select either 208 or 240. Only the correct voltage will be selectable on the screen, identifying which option to touch.

### Ventilation

The TurboChef PLEXOR oven has been approved by Underwriter's Laboratory for ventless operation (UL KNLZ listing) for all food items except for foods classified as "fatty raw proteins." Such foods include bone-in, skin-on chicken, raw hamburger meat, raw bacon, raw sausage, steaks, etc. If cooking these types of foods, consult local HVAC codes and authorities to ensure compliance with ventilation requirements.

To ensure continued compliance with all health, building, and fire codes, you are required to maintain clean and sanitary conditions around your oven at all times.

NOTE: In no event shall the manufacturer assume any liability for damages or injuries resulting from installations which are not in compliance with the instructions and codes previously listed. Failure to comply with these instructions could result in the issuance of a temporary cease and desist order from the local health department until the environment concerns are addressed.

## Daily Maintenance

Follow the steps below when cleaning your PLEXOR oven. Use only TurboChef®-approved cleaning chemicals. The use of any other cleaning products may damage critical oven components, resulting in a non-warranty service call.

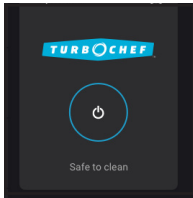

Step 1



Step 2



Step 3 (figure A)



Step 3 (figure C)



Step 4

## Supplies and Equipment

TurboChef® Oven Cleaner (Product Number: 103180), Kay ClickSan® sanitizer, nylon scrub pad, cleaning towel, disposable gloves, protective eyewear, flathead screwdriver, dust mask (optional)

### Step 1: Prepare the Oven

**⚠ WARNING:** The oven operates at approximately 500°F (260°C) and may cause injury if not allowed to cool properly.

- Turn off each oven module by touching the On/Off button for each module.
- Cooling takes approximately 30 minutes. **DO NOT** proceed to Step 2 until the module display reads “Safe to Clean.”

**⚠ WARNING:** Other modules may still be hot even if the module you intend to clean has finished cooling. Exercise caution to avoid burns.

### Step 2: Remove the Cooking Racks

**⚠ WARNING:** Be sure the oven interior is cool before removing these items.

- Remove the racks from each oven module.
- Spray with oven cleaner and let sit for 10 minutes.
- Scrub with a nylon scrub pad.
- Rinse with water and dry with a clean towel.

### Step 3: Remove the Doors

- Turn the clamp to release the door (Step 3, figure A).
- Tilt the door back to remove it (Step 3, figure B).
- Spray with oven cleaner and let sit for 10 minutes.
- Scrub with a nylon scrub pad.
- Rinse with water and dry with a clean towel.

**⚠ CAUTION:** **DO NOT** soak the rapid cook door. Doing so can damage critical oven components, resulting in a non-warranty service call.

### Step 4: Remove the Top and Bottom Jetplates (Impingement and Convection Modules Only)

- Remove the two screws securing the top and bottom jetplates. If necessary, use a flathead screwdriver.
- Pull down (top jetplate) and pull up (bottom jetplate) to remove them from the cavity.
- Spray with oven cleaner and let sit for 10 minutes.
- Scrub with a nylon scrub pad.
- Rinse with water and dry with a clean towel.



Step 5



Step 6

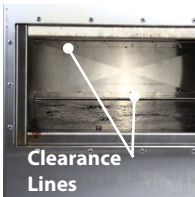

Step 7 (figure A)



Step 7 (figure B)

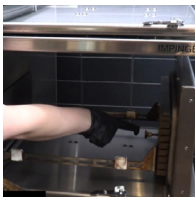

Step 7 (figure C)



Step 8

### Step 5: Clean the Oven Interior and Sled

- Use a food vacuum or damp towel to remove large particles from the oven cavity and sled.
- Spray TurboChef Oven Cleaner on the top surface of the oven sled and onto the top, bottom, and sides of the interior

**⚠ CAUTION:** DO NOT spray Oven Cleaner into any holes on the oven wall. Doing so can damage critical oven components, resulting in a non-warranty service call.

- Allow Oven Cleaner to penetrate stains for 10 minutes.
- Clean the oven interior and sled with a nylon scrub pad.
- Use a clean damp towel to wipe surfaces.

### Step 6: Clean the Air Filters

**⚠ CAUTION:** TurboChef does not recognize blocked air vents as a warrantable claim. The filter must be cleaned regularly or replaced if damaged. During oven operation, the filter must remain in place at all times.

- Remove the air filters from the back of the oven.
- Rinse the air filters with hot water.
- Allow the air filters to dry completely.

**⚠ CAUTION:** DO NOT operate the oven without the air filter in place.

### Step 7: Reinstall Components

- Reinstall the top and bottom jetplates. When installing the jetplates, make sure the top jetplate sits above the marker and the bottom jetplate sits below the marker (step 7, figure A).
- Reinstall the doors. Make sure the door notches align with the slots on the sled (step 7, figure B). Secure the door clamp.
- Reinstall the oven racks. The Rapid Cook Module has a notch that must be installed facing the door (step 7, figure C).
- Reinstall the air filters.

### Step 8: Clean the Oven Exterior

- Wipe the oven exterior with a clean, damp towel.
- Before wiping down the user interface, touch the three bars **≡** in the top-left corner to access the “Clean Screen” mode (page 10, figure 5). When this option is selected, the screen will temporarily lock for 10 seconds to allow for cleaning.

**⚠ CAUTION:** DO NOT spray chemicals into any openings, such as the louvers on the side panels or the rear vent catalyst housing. Doing so can damage critical oven components, resulting in a non-warranty service call.

- The oven is ready to turn on.

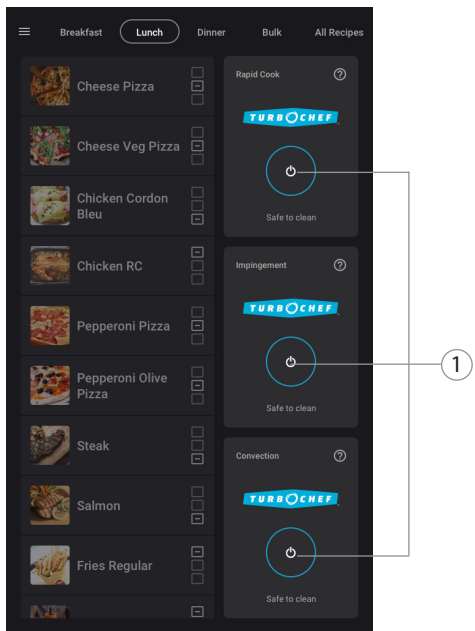

Figure 3: PLEXOR Home Screen, Ovens Off

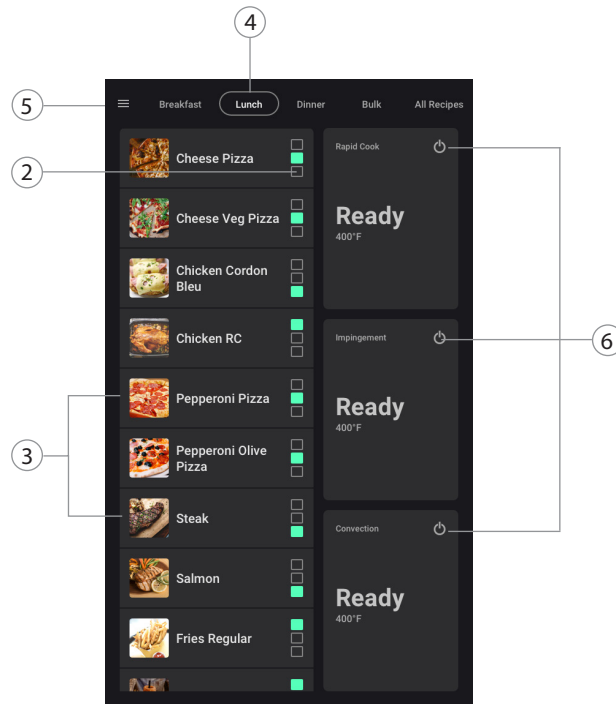

Figure 4: PLEXOR Oven Ready Screen

## Oven Controls

### 1. On Icon

Touch to start preheating each module.

### 2. Oven Status

The three boxes correspond with the three modules top to bottom.

Green: Cavity is ready to be loaded

Orange: Cook cycle is in progress

Gray: Cavity is unavailable; i.e., the recipe was not developed for the module type (see page 15 for more information).

### 3. Menu Items

Place the food in the appropriate module tray and touch the menu image/name to start the cook cycle. The door will automatically load and unload.

### 4. Group Name

Touch the group name at the top to view items in that group only. Swipe/scroll left to right to view additional groups or add/edit groups. Touch All Recipes to view all menu items.

### 5. Menu

Touch to access additional settings and configurations (some may be password restricted). See page 10 for more information.

### 6. Off Icon

Touch to turn off the module (cool down).

## Preset Cooking Instructions

The oven is programmed with recipe settings at the time of manufacture and is ready to operate out of the box. New menu settings can be loaded via USB (page 16) or programmed manually (page 11).

This oven uses impingement, convection, and microwave to cook food faster than traditional cooking methods. As air enters the cavity, fan(s) are designed to move air through the jetplates to ensure uniformity of cooking. While the jetplates are removable for cleaning, they are not removable for cooking. Without the jetplate(s) in place, the oven will not deliver the proper cooking performance to either the top or bottom of the food item. Additionally, a non-warranty service call may result.

The sequence of the steps below may vary, and some may not apply.

### Step 1: Turning the Oven ON

- Touch the power button on the module (or modules) that will be used for cooking. The module will begin preheating.
- When the module reaches the set temperature, recipes will be selectable for cooking.

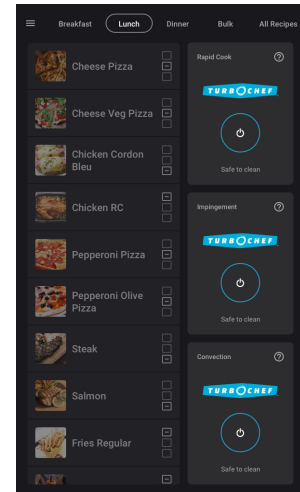

Step 1

### Step 2: Preheating

- It should take approximately 10-15 minutes for the oven to preheat.
- When the preheat temperature is reached, the module will start a countdown from 5 minutes to allow the temperature to stabilize. Once complete, the oven will display “Ready.”
- Cooking can begin on modules that are ready even if others are still warming up.

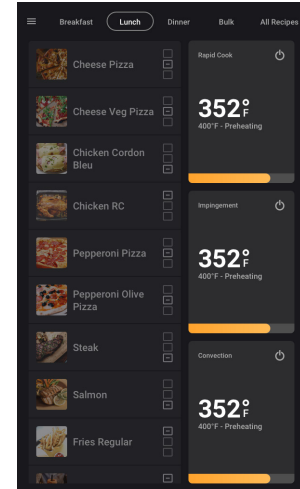

Step 2



### Step 3: Place Food on the Cook Rack of the Available Module



**WARNING:** Inside of oven and oven door are hot!

### Step 4 (Optional): Select a Group

- From the top navigation bar, select a group. Scroll left to right to view additional groups.

### Step 5: Select a Menu Item

- Navigate to the desired recipe. Scroll up and down to view additional recipes. Pressing the recipe will load the food and start the cook.

### Step 6: Cooking

- During the cook, the module bar will indicate the time remaining. The menu area will display details on the current cook setting. The cook can be cancelled by touching the red stop button or paused with the white pause button.
- Pausing a cook will eject the food and allow for inspection until the user confirms the cook cycle can be resumed or cancelled.
- While a cook cycle is in progress for a given module, you can cook other products in other modules.

### Step 7: Remove the Dish



**WARNING:** Dish/inside of oven and door are hot!

- When the cook cycle is completed, the door will automatically open.
- If applicable, a count-up timer will show on the display to indicate how long the menu item has been waiting on the cooking rack.

### Step 8: Oven Cool Down

- Touch the off icon for each module you wish to cool down.
- The module will take roughly 30 minutes to cool down to a temperature of 140°F/60°C. See pages 5-6 for cleaning instructions.

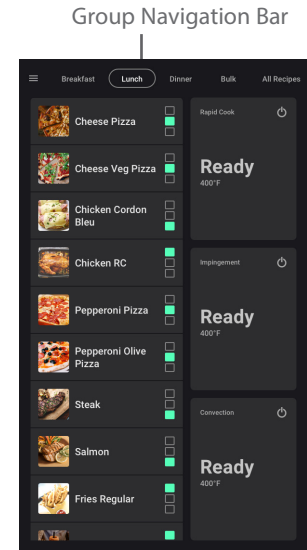

Menu Items  
Steps 4-5

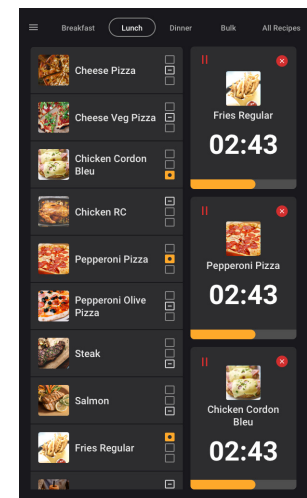

Step 6

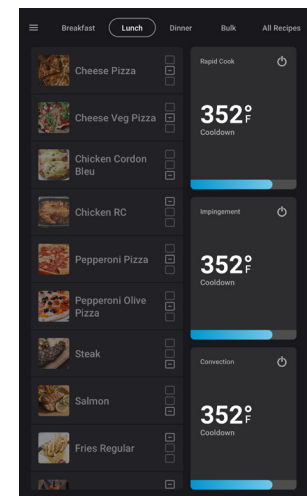

Step 8

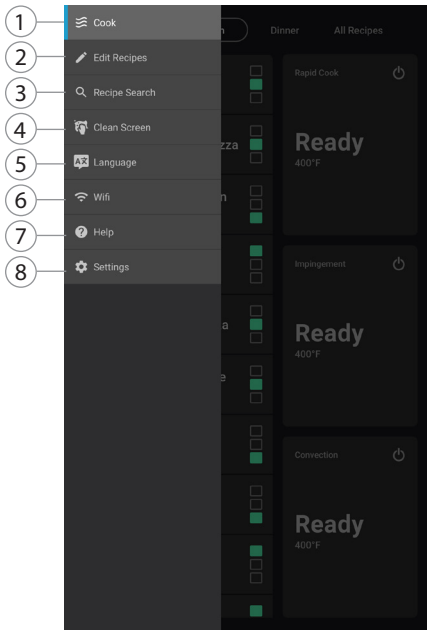

Figure 5: PLEXOR Oven Menu

## Menu Options and Settings

Touch the three bars **≡** in the top-left corner to access the following menu items.

1. **Cook**  
Touch to close the menu screen and return to the main cooking screen.
2. **Edit Recipes**  
From this screen, users can change menu settings, rename food groups and items, and change the cooking temperature. This option can be password protected from the Settings screen. See page 11 for more information.
3. **Recipe Search**  
Quickly search for recipe names and keywords from this screen.
4. **Clean Screen**  
When this option is selected, the screen will temporarily lock for 10 seconds to allow for cleaning.

### 5. Language

The default language is English. To change to another language, touch “Language: English” and then touch the preferred language and touch “ENTER.” The available languages are Chinese (Simplified), Chinese (Traditional), Danish, Dutch, French, French-Canadian, German, Italian, Japanese, Korean, Polish, Portuguese, Russian, Spanish, and Swedish.

### 6. WiFi

The PLEXOR oven is compatible with Powerhouse Dynamics ConnectWare®, an externally-mounted connectivity module that can utilize one or more connection methods such as WiFi, MiWi, and Ethernet. The WiFi option on the PLEXOR display shows signal strength and allows the ConnectWare module to be configured to connect to different access points.

NOTE: By default, ConnectWare® is configured to connect to the Powerhouse Dynamics Secure Access Point, as part of its PCI-level 1 compliant cloud-based equipment management system, *Open Kitchen*. For more information, visit [powerhousedynamics.com](http://powerhousedynamics.com)

### 7. Help

Select “Help” for access to training videos and tutorials, which are typically provided in the form of QR codes.

### 8. Settings

Select “Settings” to:

- View oven info, including serial number, menu version, firmware version, et cetera.
- Counters, including total on time, total cook time, etc.
- Enable/disable options including Load Menu from USB, Menu Edit, et cetera.

The pass code for Settings is 9 4 2 8.

## Editing Recipe Parameters

From the Edit Recipes screen, users can:

- Rename food groups and items
- Add keywords
- Add/replace image and icons
- Copy or move a recipe to another group
- Remove a recipe
- Change cook settings

NOTE: Enable or disable recipe edit from the Settings screen (page 10).

Follow the instructions below to access the Edit Recipe screen:

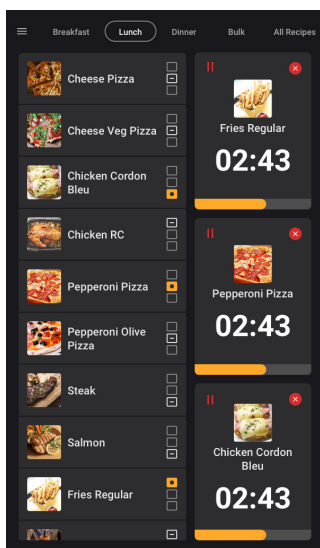

- ① Touch the three bars  in the top-left corner.

Figure 6: Access Menu Options



- ② Select the item to be edited.

Figure 7: Select Recipe to Edit

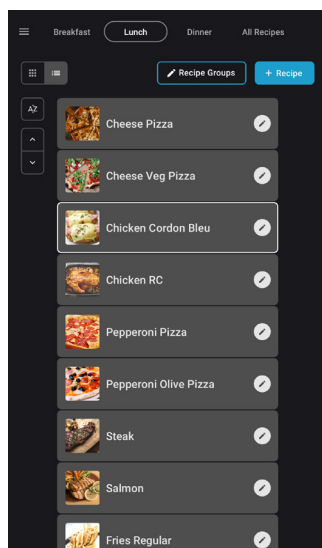
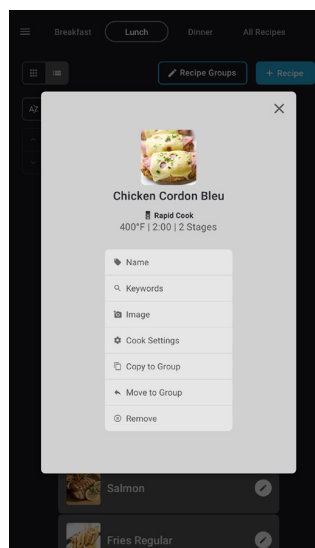

- ③ The edit menu will appear as a pop-up.

Figure 8: Recipe Edit Options

### Editing Name

From the Edit Recipe screen, touch the name icon. Type the new name and touch enter. 

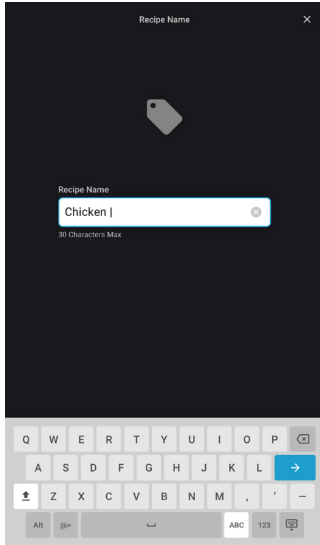



Figure 9: Edit Recipe Name

### Keywords

From the Edit Recipe screen, touch the Keyword icon. Add or remove keywords (separate the keywords using a comma) and touch enter.  Keywords will assist when searching for an item.

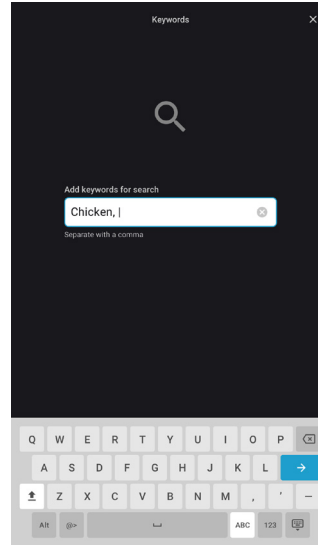

Figure 11: Edit Keywords

### Image

From the Edit Recipe Screen, touch “Image” to add a new image or replace the existing image. You can also upload from a USB. Once done touch the Save icon.



Figure 10: Edit Recipe Image or Icon

### Copy or Move to a New Group

From the Edit Recipe Screen, touch “Copy Group” or “Move Group”. Select the target group and touch the Save icon.

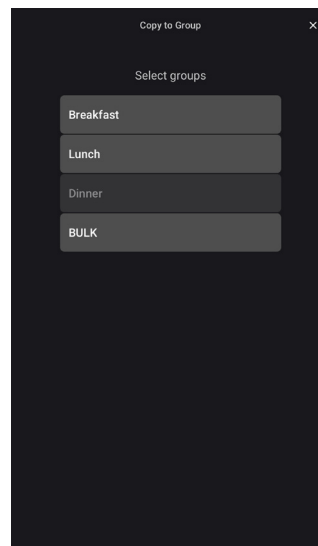

Figure 12: Copy or Move Recipe to New Group

## Remove a Recipe

From the Edit Recipe screen, touch the Remove icon, and then the next Remove icon to confirm your selection.

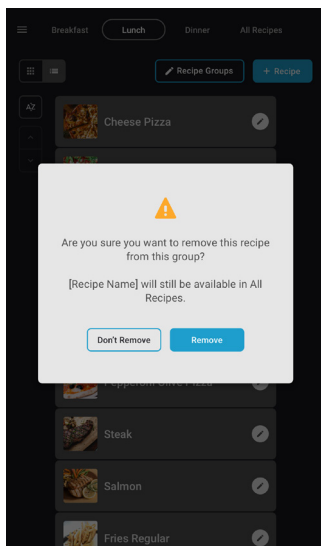

Figure 13: Remove Recipe

## Editing Group

From the Edit Recipe Screen, touch the “Edit Recipe Groups” button. From this screen, you can:

- Create a new group
- Edit group parameters, such as name and image/icon
- Edit which recipes go in which groups

## Editing Cook Settings

From the Edit Recipe Screen, touch “Cook Settings.”

### 1. Oven Modules

Touch the module area to select Rapid Cook, Impingement, or Convection (see page 15 for more info).

### 2. Add Stages

Add stages for each recipe.

### 3. Comments

Add comments for recipes, if desired. A comment is text that appears before or after a stage and is used to instruct or inform the oven operator. For example: “add cheese now.”

### 4. Temperature

Set the cook temperature for the recipe. Bear in mind that recipes set to different temperatures may decrease operational efficiency, as the oven may need to warm up or cool down between cook cycles. An optimized menu will have recipes with similar set temperatures, which will allow those recipes to be added to groups/day parts and minimize warming/cooling delays that may adversely affect busy times.

### 5. Time

Set the cook time.

### 6. % Air

% Air determines the amount of airflow. The more air, the more the product will brown or crisp. “% Air” can be set from 10-100% in 10% increments.

NOTE: Impingement modules have independently-controlled top and bottom air.

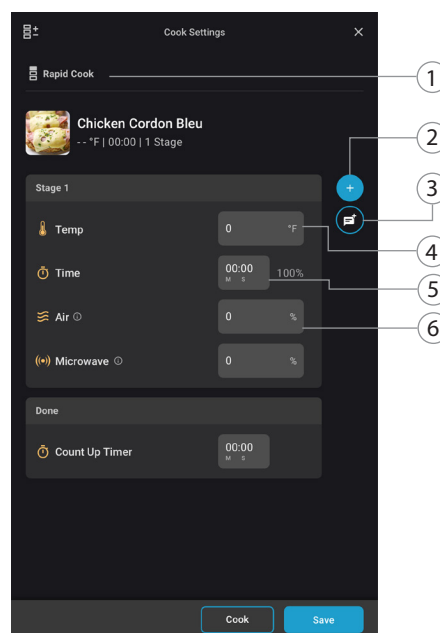

Figure 14: Edit Cook Settings (1 of 2)

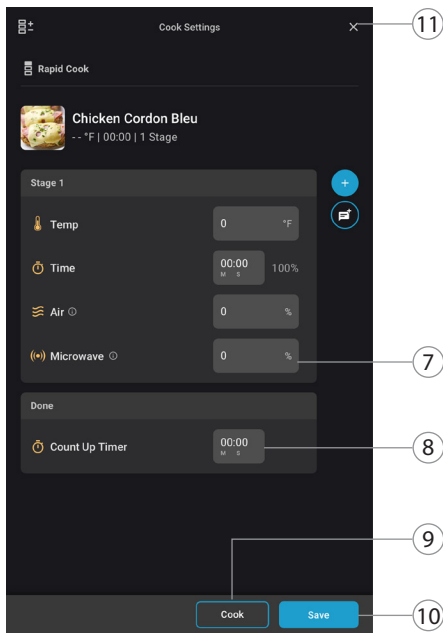

Figure 15: Edit Cook Settings (2 of 2)

7. **% Microwave (Rapid Cook Module Only)**  
“% Microwave” can be set from 0-100% in 5% increments. By default, the percentage represents the percentage of microwave power for the entire duration of cook time.

NOTE: There is a “Pulse” option. When pulse is set to “Off” microwave will be applied as stated above. When set to “On” the percentage represents the number of consecutive seconds the microwave remains on during a cook cycle during a given 10-second period. For example, 50% means the microwave system will remain on for five continuous seconds for every ten seconds during the cook cycle. The pulse option is recommended for food products being cooked from frozen, food products requiring defrosting, or delicate products such as pastries, etc.

8. **Count Up Timer**  
The count-up timer is an optional alert for after a cook cycle finishes to ensure the cooked food product is being attended to in a timely manner.
9. **Cook**  
Touch the Cook button to run a test cook cycle for the settings that are currently displayed on the screen.  
  
NOTE: The oven may need time to warm up.
10. **Save**  
Touch to save all changes.
11. **Cancel**  
Touch to cancel all changes.

## Oven Module Prioritization

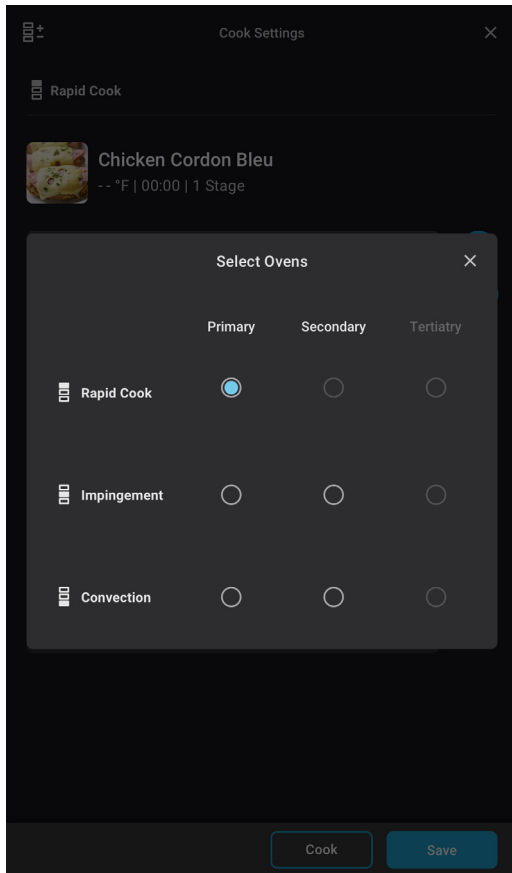

Figure 16: Module Prioritization

The oven module prioritization setting eliminates guesswork on the part of the oven operator and helps ensure the food product is cooked to optimal quality, while also helping to balance the need to maximize throughput during busy times.

From the Cook Settings screen, touch the module icon. Touch the button to the corresponding oven to set the primary, secondary, and tertiary module.

“Primary” will designate the cooking module for the oven operator to load when multiple modules are available for use. Recipes developed for use in a primary module are optimized for food quality.

“Secondary” will designate the cooking module for the oven operator to load when the designated primary module is in use. Recipes developed for use in a secondary module will produce acceptable, if not optimal, food quality.

“Tertiary” will designate the cooking module for the oven operator to load when the designated primary and secondary modules are in use. Recipes developed for use in a tertiary module will produce acceptable, if not optimal, food quality.

## USB Operation

While all oven modules are either cooling down or off, insert a USB drive into the USB port on the PLEXOR. The user will be prompted to “Save Recipes,” “Update,” or “Cancel.”

**Save Recipes:** This option will back up the recipes on the PLEXOR to a USB drive. These settings can then be applied to other PLEXOR ovens.

**Update:** The “Update” option will load the update file currently on the USB drive to the PLEXOR oven. This file may be a new menu/recipe file or a software update. This option will not appear if there is no update file on the USB drive. For menu/recipe updates, the oven takes a TGZ (compressed file) that contains a folder structure, recipe settings file, and all associated icons. A software/firmware update will only be performed in this manner when/if instructed by the factory, using a USB drive that has been formatted by the factory.

**Cancel:** This selection will ignore the USB drive until it is removed and reinserted.

## Troubleshooting

The adjacent table is a list of fault codes and error messages, along with the possible problem(s) that the oven may experience. Please attempt the recommended action before calling Customer Support (800.90TURBO, +1 214.379.6000) or your Authorized Distributor.

If any fault or error message occurs that is not listed below, contact Customer Support (800.90TURBO, +1 214.379.6000).

 **WARNING:** Food, oven door, and oven cavity are hot! Use extreme caution when troubleshooting the issues below.



Issue	Possible Cause(s)	Resolution
No power to oven.	<ul style="list-style-type: none"> <li>- Oven is not plugged in.</li> <li>- Main circuit breaker is tripped.</li> </ul>	<ul style="list-style-type: none"> <li>- Plug the oven in.</li> <li>- Verify the wall circuit breaker is on. Reset the breaker, then power the oven back on.</li> </ul>
Oven is not cooking properly.	<ul style="list-style-type: none"> <li>- Oven is not clean. (Large deposits of grease, carbon, or food debris dilute the microwave.)</li> <li>- Incorrect group and/or item name was selected for the product.</li> <li>- Product was not cooked from correct starting state (for example, chilled or frozen).</li> <li>- Product out of specification.</li> </ul>	<ul style="list-style-type: none"> <li>- Clean the oven following the cleaning instructions on pages 5-6.</li> <li>- Ensure the correct food group and/or item was selected.</li> <li>- Ensure the product was in the correct state before being placed in the oven.</li> <li>- Ensure the product is exactly the same weight/size as the typical product.</li> </ul>
F1: Blower Running Status Bad	<ul style="list-style-type: none"> <li>- Oven power interrupted.</li> </ul>	<ul style="list-style-type: none"> <li>- Turn the oven off and unplug the oven – leave for two minutes. Re-plug in the oven, switch on the isolator/main power supply, and try operating the oven.</li> </ul>
F2: Cook Temperature Low	<ul style="list-style-type: none"> <li>- Air nozzles on the top/bottom of the cook cavity are clogged.</li> <li>- Defective heater.</li> <li>- Blower motor not running.</li> <li>- Oven not fully warmed up.</li> </ul>	<ul style="list-style-type: none"> <li>- During daily cleaning, make sure to unclog the air nozzles on the top/bottom of the cook cavity.</li> <li>- Reset the high-limit thermostat located on the oven rear wall.</li> <li>- Call Customer Support.</li> <li>- Repeat preheat and allow the oven to idle for five minutes.</li> </ul>
F5: Magnetron Over Temperature	<ul style="list-style-type: none"> <li>- Blockage of cool air into the oven.</li> <li>- Rear filter intakes clogged.</li> </ul>	<ul style="list-style-type: none"> <li>- Remove anything that may be obstructing the flow of cool air into the oven panels.</li> <li>- Make sure the rear filter intakes are free of debris.</li> </ul>
F6: EC Temp	<ul style="list-style-type: none"> <li>- Blockage of cool air into the oven.</li> <li>- Rear cooling fan exhaust guard(s) clogged.</li> </ul>	<ul style="list-style-type: none"> <li>- Remove anything that may be obstructing the flow of cool air into the oven panels.</li> <li>- Make sure the rear fans are free of debris.</li> </ul>

# North America Limited Warranty

## TurboChef PLEXOR Oven – North America

The TurboChef PLEXOR oven Limited Warranty outlined below is activated upon shipment of your oven. Should you require additional assistance after reviewing the warranty outlined below, please call TurboChef Customer Support at 800.90TURBO.

### Limited Warranty

TurboChef Technologies, LLC (“TurboChef”) warrants to you, the purchaser, that under normal use the TurboChef PLEXOR oven you have purchased (the “Equipment”) will be free from defects in material and workmanship during the Warranty Period, subject to the terms and conditions set forth herein. The “Warranty Period” is twelve (12) months from the date the Equipment is shipped from TurboChef’s U.S. factory or distribution center. This warranty is conditioned upon you promptly notifying TurboChef of any claims, as provided in the paragraph entitled “Warranty Claims” below, and providing TurboChef with all data and information requested by TurboChef or its service agents in connection with such claims as well as all necessary access to your premises and the Equipment. This warranty is made only to the initial purchaser of the Equipment from TurboChef or its authorized dealer; it is not assignable to subsequent purchasers unless TurboChef consents to such assignment in writing.

### Disclaimer of Warranties

Except as provided in the Limited Warranty above, the Equipment is provided “as-is”. TurboChef disclaims all other warranties, express, statutory or implied, including without limitation, the implied warranties of title, non-infringement, merchantability and fitness for a particular purpose. TurboChef does not warrant that the Equipment will meet your specifications or needs. You acknowledge that you are solely responsible for the selection of the Equipment and determining the suitability of the Equipment for your needs.

### Warranty Exclusions

**Improper Installation, Operation or Maintenance:** Equipment that is not installed, operated and maintained in accordance with TurboChef’s PLEXOR oven owner’s manual (as may be updated by TurboChef from time to time, the “Manual”), a copy of which is provided to you with the Equipment or otherwise will be furnished to you upon request, is excluded from this warranty. This warranty does not apply to damage or failure which results, in TurboChef’s or its service agent’s sole opinion, from failure to provide a suitable installation and operating environment (including power and HVAC) and facilities as prescribed by the Manual, misuse, abuse, accident, neglect, power failure or power surges (over or under voltage), or to damage or failure from flood, fire, lightning or other natural or man-made disasters, or other Acts of God, or to Equipment that has missing or altered serial numbers.

**Modifications and Repair:** Equipment that has been modified or altered by persons other than TurboChef or its service agents, or Equipment that has had non-approved devices or connection items attached thereto, is excluded from coverage under this warranty. Repair of the Equipment by anyone other than TurboChef or its authorized service agents will void all warranties on the Equipment.

**Accessories:** Accessories and parts (collectively “Accessories”) that are consumed in the normal course of Equipment operation or maintenance are excluded from this warranty. Failure of or damage to Equipment or components from the use of non-approved cleaning chemicals, devices or processes is also excluded from this warranty. Accessories may include, but are not limited to, ceramic cooking platters, paddles and approved cleaning chemicals and devices.

**Lower Jetplate and Porcelain-coated Oven Components:** Minor chipping in the porcelain is to be expected as a result of regular usage. Replacement or repair for cosmetic defects and/or damage to porcelain-coated oven components, including but not limited to the lower jetplate, is excluded from this warranty.

**Outstanding Invoices:** If the full invoiced amount for Equipment purchased has not been paid within forty-five (45) days from the invoice date, then TurboChef will have no obligation to honor this or any other warranty on the Equipment until payment is received in full, including any accrued interest or other charges, has been satisfied, at which time warranty coverage will be reinstated, but the Warranty Period will not be extended.

### **Warranty Service, Exclusive Remedy**

TurboChef will be solely responsible for determining whether or not the Equipment or any component thereof is defective. Defective components covered by this warranty will be repaired or replaced at TurboChef's option without charge to you and such repaired or replacement components will be covered by this warranty for the balance of the Warranty Period. Parts used in the repair of defective components and replacement components may be new, recovered or rebuilt. At its sole option, TurboChef may decide to replace defective Equipment covered by this warranty with new, recovered or rebuilt Equipment of equal or greater capability, and such Equipment will be covered by this Limited Warranty for the balance of the Warranty Period. Defective Equipment and components will become the property of TurboChef. This paragraph states TurboChef's sole and exclusive obligation and liability and your sole and exclusive remedy under this warranty. TurboChef shall not be responsible for a failure to provide warranty services due to causes beyond TurboChef's or its service agents' control.

### **Warranty Claims**

Claims under this warranty must be reported to TurboChef during our normal working hours at 800.90TURBO, or such other reporting service as TurboChef may designate. Upon receipt of the claim and related information and preliminary verification that the claim is valid, TurboChef will promptly notify an authorized service agent to contact you and arrange for an on-site repair visit during the service agent's normal working hours. Any costs incurred by TurboChef or its service agent associated with a service agent being refused or unable to gain access to the Equipment on your premises, or a claim not covered by this warranty, will be charged to you.

### **Disclaimer of Damages**

TurboChef disclaims all incidental, special and consequential damages, including but not limited to loss of use, lost revenue or profits, or substitute use, suffered by you or any third party, whether arising in contract, tort (including negligence), or otherwise, resulting from any breach by TurboChef or its service agents of this warranty, or resulting from the manufacture, use, or defects, of or in the Equipment, even if TurboChef was apprised of the possibility of such damages.

### **Customer Indemnity**

You agree to indemnify, defend and hold TurboChef harmless from all third party claims, demands, judgments, fees and costs directly or indirectly arising out of or related to your use of the Equipment. You further agree to indemnify and hold TurboChef harmless from any incidental, consequential or special damages suffered by you, including lost revenue or profits, loss of use, or substitute use, during periods of Equipment failure or loss of use.

### **Territory**

This warranty is valid in the United States of America, Canada and Puerto Rico.

### **Governing Law, Entire Warranty**

This warranty shall be governed and construed in accordance with the laws of the State of Texas, USA (except with respect to its provisions regarding conflicts of laws). The warranty described herein is the complete and only warranty for Equipment and supersedes all prior oral or written agreements and understandings that may have existed between us relating to Equipment warranties. The terms of this warranty may not be altered, amended or modified except by a signed writing from TurboChef. Any purported alteration, amendment or modification by a service agent or anyone else will not be enforceable against TurboChef.

### **Charges for Non-Warranty Service or Rejection of Service Visit**

In the event that repairs, replacement or service are provided by TurboChef's service agents for work not covered by this limited warranty, customer agrees to pay the service agent directly according to the service agent's normal scale of charges. In the event TurboChef is invoiced by the service agent for services not covered under this extended warranty, TurboChef will invoice customer and customer will pay such invoice based on terms of net 10 days. Customer also agrees to pay any cost incurred by TurboChef or its service agent associated with a service agent responding to a call for service, but then being refused or unable to gain access to the Oven on Customer's premises. Failure to submit payment may, at TurboChef's discretion, result in TurboChef voiding the balance of the warranty. In no event will TurboChef authorize service to a store with an outstanding Non-Warranty invoice.

# International Limited Warranty

This Limited Warranty shall apply to the sales of all TurboChef PLEXOR ovens (the “Equipment”) manufactured by TurboChef Technologies, LLC (“TurboChef”), and sold to purchasers outside of the United States, Canada, Puerto Rico, Central and South America by an Authorized Distributor of TurboChef International (the “Authorized Distributor”).

## Limited Warranty

You, the purchaser (“You”) have entered into a sales contract with the Authorized Distributor for the purchase of the Equipment. This Limited Warranty is made to you by the Authorized Distributor from whom you purchased the Equipment with the support of TurboChef. Subject to the limitations stated below, the Authorized Distributor warrants to You that the quantity and specification of the Equipment delivered to You shall be as set out in the Authorized Distributor’s acceptance of your order and that the Equipment will be free from any material defects in the product and workmanship for twelve (12) months from the date of installation (the “Warranty Period”), subject to the terms and conditions set forth herein.

## Disclaimer

You acknowledge that You are solely responsible for the selection of the Equipment and determining the suitability of the Equipment for Your needs. All other warranties, conditions or terms relating to fitness for purpose, quality or condition of the Equipment, whether expressed or implied by statute or common law or otherwise are excluded to the fullest extent permitted by law.

## The TurboChef Global Warranty System

This Limited Warranty commences upon delivery of the Equipment to Your premises. The Authorized Distributor will inspect and install the Equipment at Your premises in accordance with TurboChef’s instructions and will record the serial number of the Equipment, Your contact details, the date and location of installation and the results of the Authorized Distributor’s inspection. This information will be entered by the Authorized Distributor into the TurboChef global warranty system and will be used by TurboChef, the Authorized Distributor and its authorized service agents for the provision of the warranty service.

## Warranty Service

During the Warranty Period, any materially defective Equipment will be repaired or replaced free of charge at TurboChef’s option provided that:

1. You notify the Authorized Distributor from whom You purchased the Equipment and/or TurboChef as soon as reasonably possible after discovery of a defect and in accordance with the warranty claims procedure set out below;
2. You provide the Authorized Distributor from whom You purchased the Equipment and/or TurboChef with all data and information reasonably requested by TurboChef, the Authorized Distributor or its authorized service agents in connection with Your warranty claim;
3. You make the Equipment available to TurboChef, the Authorized Distributor or its authorized service agents;
4. The Equipment has been installed by an Authorized Distributor and you have provided all necessary information for the Authorized Distributor to register the Equipment in the TurboChef global warranty system;
5. The Equipment has been operated and maintained by You in accordance with TurboChef’s “Owner’s Manual” provided with the Equipment (and as updated by TurboChef);

6. You have not used any non-approved devices, accessories, consumables or parts in conjunction with the Equipment; and
7. Repairs, modifications or alterations have not been attempted other than by TurboChef, an Authorized Distributor or its authorized service agent.

Neither TurboChef nor the Authorized Distributor assumes any liability for damage caused by Your failure to provide a suitable installation and operating environment (including power and HVAC) or facilities as prescribed by the Manual, misuse or abuse or by accident, neglect, power failure or power surges (over or under voltage) howsoever arising.

At its sole option, TurboChef may replace defective Equipment or components with new, recovered or rebuilt Equipment of equal or greater capability, and such Equipment or components will be warranted by the Authorized Distributor for the balance of the Warranty Period. Replaced defective Equipment or components will become the property of TurboChef.

**Warranty Claims:** Any warranty claim must be made directly in writing either to the Authorized Distributor from whom You purchased the Equipment or to TurboChef at the following address:

TurboChef Technologies, LLC  
 2801 Trade Center Drive  
 Carrollton, Texas 75007  
 Phone: +1 214.379.6000  
 Fax: +1 214.379.6073

The claim must include the serial number of the Equipment and be received by TurboChef on or before the last day of the Warranty Period. Upon receipt of Your claim, TurboChef will promptly notify an Authorized Distributor or an authorized service agent to contact You, to verify Your claim and, if necessary, to arrange for an on-site repair visit during normal working hours.

**Consumables and Parts Used with The Equipment:** Neither TurboChef nor the Authorized Distributor assumes any liability for consumables and parts that are used in the normal course of Equipment operation or for failure of or damage to Equipment or components from the use of non-approved cleaning chemicals, devices or processes.

**Lower Jetplate and Porcelain-coated Oven Components:** Minor chipping in the porcelain is to be expected as a result of regular usage. Replacement or repair for cosmetic defects and/or damage to porcelain-coated oven components, including but not limited to the lower jetplate, is excluded from this warranty.

**Charges for Service Not Covered by Limited Warranty:** In the event that You request and receive repairs, replacement or service not covered by this Limited Warranty, You will be invoiced and must pay the Authorized Distributor or authorized service agent directly according to its normal scale of charges and business terms.

**Product Liability:** Neither TurboChef nor the Authorized Distributor assumes any liability for any incidental, special or consequential damages, including but not limited to loss of use, lost revenue or profits, or substitute use suffered by You or any third party, whether arising in contract, tort (including negligence), or otherwise resulting from any breach by TurboChef or the Authorized Distributor of the Limited Warranty provided herein.

**Exclusive Remedy:** This Limited Warranty states the Authorized Distributors and TurboChef's sole and exclusive obligation and liability and your sole and exclusive remedy under this Limited Warranty.

**Third Party Rights:** The UK Contract (Rights of Third Parties) Act 1999 is excluded from applying to this Limited Warranty and nothing herein confers or purports to confer on any third party any benefit or any right to enforce any term of this Limited Warranty.

**Severability:** If any item or provision contained in this Limited Warranty or any part of them (“an offending provision”) is declared to be or becomes unenforceable, invalid or illegal for any reason whatsoever in any jurisdiction, the other terms and provisions of this Limited Warranty shall remain in full force and effect in that jurisdiction as if it had been executed without the offending provision appearing in it and the entire Limited Warranty shall remain in full force and effect in all other jurisdictions.

**Governing Law, Entire, Agreement:** This Limited Warranty shall be governed by and construed according to English law. The application of the United Nations Convention on International Sale of Goods to this Limited Warranty is expressly excluded. This Limited Warranty may not be altered, amended or modified by the Authorized Distributor or its service agent, and no representation, alteration, amendment or modification by TurboChef shall be valid unless in a signed form from TurboChef.



*For service or information:*

WITHIN NORTH AMERICA CALL

Customer Support *at* 800.90TURBO

OUTSIDE NORTH AMERICA CALL

+1 214.379.6000 or Your Authorized Distributor



Part Number: DOC-1824 / Revision D / October 2021  
Country Code: NA/EU

*Global Operations*

2801 Trade Center Drive  
Carrollton, Texas 75007 USA  
+1 214.379.6000 PHONE  
+1 214.379.6073 FAX

*Customer Support*

800.90TURBO  
+1 214.379.6000  
turbochef.com