

# PLEXOR A3

# TURBOCHEF

## Features & Benefits

- Three (3) cooking technologies in one (1) appliance: rapid cook, impingement, convection, or any combination
- Operated by a single plug
- Simple and intuitive one-touch controls with icons
- Autoload/unload
- Ventless – integral recirculating catalytic converter for UL® (KNLZ) listed ventless operation
- Adaptive power management ensuring consistent results while power sharing
- Modular design: mix and match to fit your menu – change configuration with module field swaps
- Available in left-to-right or right-to-left configurations
- Smart menu system capable of storing unlimited recipes
- Comes standard with cart and sealing gasket
- Open Kitchen™ ready
- Includes plug and cord (6 ft. nominal)

## Connectivity Part Numbers

- MDD-1001 - Initial equipment, two way connectivity bundle
- MDD-1002 - Additional equipment, two way connectivity bundle
- MDD-1005 - Additional year of subscription (PhD SAAS)

\* View standard accessories on page 3



Shown above with the impingement, rapid cook and convection modules installed. See following pages for more information.

### VENTILATION

- UL (KNLZ) listed for ventless operation.†
- EPA 202 test (8 hr):
  - Product: Pepperoni Pizzas
  - Convection Results: 0.20 mg/m<sup>3</sup>
  - Impingement Results: 1.33 mg/m<sup>3</sup>
  - Rapid Cook Results: 1.05 mg/m<sup>3</sup>
  - Ventless Requirement: <5.00 mg/m<sup>3</sup>
- Internal catalytic filtration to limit smoke, grease, and odor emissions.

OPEN  
KITCHEN



## SPECIFICATIONS

**PHASE**  
3 Phase

**VOLTAGE**  
208/240V

**CURRENT**  
39A-49A

**MAX CIRCUIT**  
50A

**PLUG**  
NEMA 15-50P



This product conforms to the ventilation recommendations set forth by NFPA96 using EPA202 test method.

\* Smart Voltage Sensor Technology does not compensate for lack of or over voltage situations. It is the responsibility of the owner to supply voltage to the unit according to the specifications on the back of this sheet.

† Ventless certification is for all food items except for foods classified as "fatty raw proteins." Such foods include bone-in, skin-on chicken, raw hamburger meat, raw bacon, raw sausage, steaks, etc. If cooking these types of foods, consult local HVAC codes and authorities to ensure compliance with ventilation requirements.

If you have questions regarding ventless certifications or local codes, please email [ventless.help@turbochef.com](mailto:ventless.help@turbochef.com) TurboChef reserves the right to make substitutions of components or change specifications without prior notice.

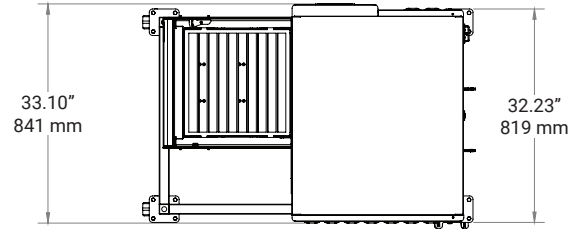
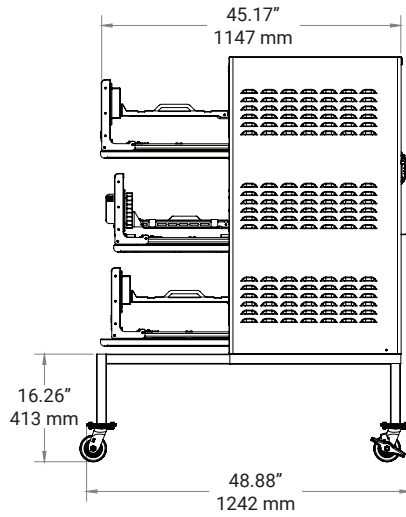
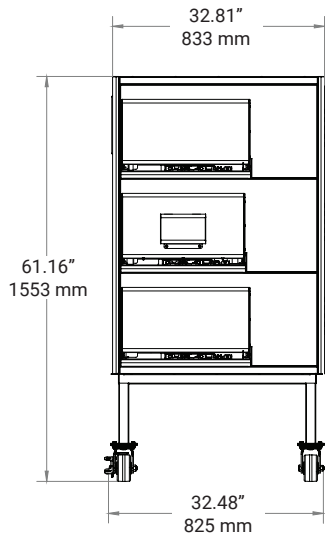

### LEFT TO RIGHT/RIGHT TO LEFT

Height	61.16"	1553 mm
Width	48.88"	1242 mm
Depth	32.81"	833 mm

### OVEN ONLY

Height	44.90"	1140 mm
Width	45.17"	1147 mm
Depth	33.10"	841 mm
Weight	610 lb.	277 kg

### WALL CLEARANCE

Top	2"	51 mm
Sides	2"	51 mm

### SHIPPING

Freight Class	175
Cube	48"x72"x58"
Shipping Weight	670 lb. (304 kg)
F.O.B.	Carrollton, TX

### IMPINGEMENT – COOK CHAMBER

Height	3.4"	86 mm
Width	16.5"	419 mm
Depth	16.3"	414 mm
Volume	0.53 cu.ft.	15.0 liters

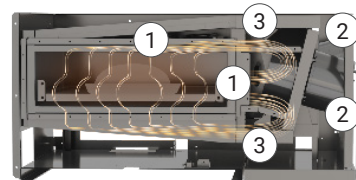

1. Heating Elements
2. Blower Motors
3. Catalytic Converters

### RAPID COOK – COOK CHAMBER

Height	4.2"	107 mm
Width	14.0"	356 mm
Depth	14.0"	356 mm
Volume	0.48 cu.ft.	13.6 liters

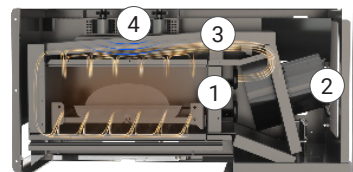

1. Heating Elements
2. Blower Motor
3. Catalytic Converter
4. Top-launched Microwave

### CONVECTION – COOK CHAMBER

Height	3.7"	94 mm
Width	16.5"	419 mm
Depth	16.3"	414 mm
Volume	0.57 cu.ft.	16.1 liters

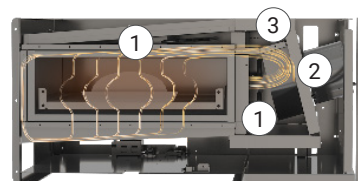

1. Heating Elements
2. Blower Motors
3. Catalytic Converters

# STANDARD ACCESSORIES

R = RAPID COOK MODULE

I = IMPINGEMENT MODULE

C = CONVECTION MODULE

PART NUMBER	RIC	CRR IRR	RRR	III IIC CCC CCI
105596	3	1		4
105597	1	1		2
105598	2	4	6	
105701	1	1	1	1
NGC -1478	1	1	1	1

SEE TABLE BELOW FOR PART NUMBER DESCRIPTIONS

PART NUMBER	DESCRIPTION
105596	BASKET, 15.5 X 15.5 X.5, TEFLON (O-WPB-1009, SOLID)
105597	BASKET, 15.5 X 15.5 X.5, TEFLON (O-CPB-1009, PERF)
105598	BASKET, 12.65 X 13.25 X .375, TEFLON (O-WPB-1008, SOLID)
105701	OVEN CLEANER, GUARD KIT
NGC -1478	PADDLE, ALUMINUM

# STANDARD CONFIGURATION

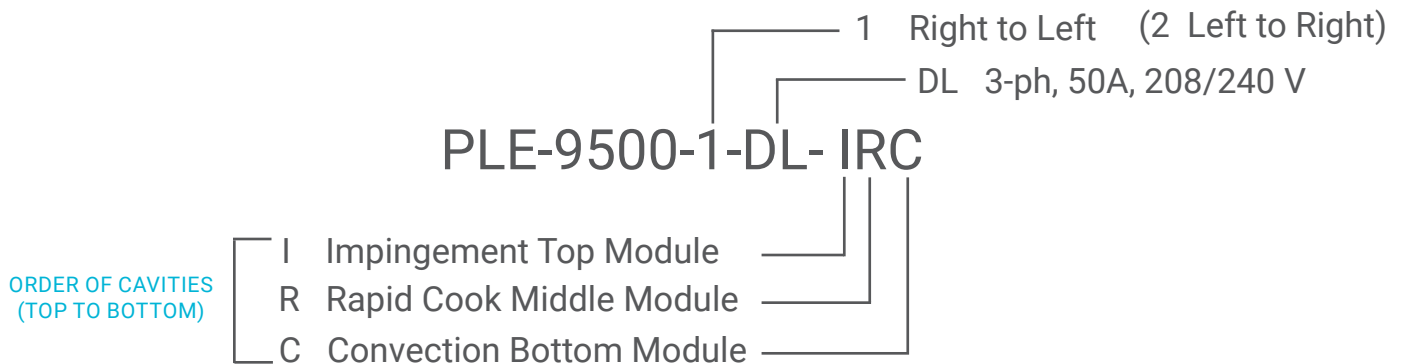

SEE PAGE 4 FOR FULL LIST OF CONFIGURATIONS

# CONFIGURATIONS

## 1 RIGHT TO LEFT

## 2 LEFT TO RIGHT

PLE-9500-1-DL-CCC	PLE-9500-2-DL-CCC
PLE-9500-1-DL-CCI	PLE-9500-2-DL-CCI
PLE-9500-1-DL-CCR	PLE-9500-2-DL-CCR
PLE-9500-1-DL-CIC	PLE-9500-2-DL-CIC
PLE-9500-1-DL-CII	PLE-9500-2-DL-CII
PLE-9500-1-DL-CIR	PLE-9500-2-DL-CIR
PLE-9500-1-DL-CRC	PLE-9500-2-DL-CRC
PLE-9500-1-DL-CRI	PLE-9500-2-DL-CRI
PLE-9500-1-DL-CRR	PLE-9500-2-DL-CRR
PLE-9500-1-DL-ICC	PLE-9500-2-DL-ICC
PLE-9500-1-DL-ICI	PLE-9500-2-DL-ICI
PLE-9500-1-DL-ICR	PLE-9500-2-DL-ICR
PLE-9500-1-DL-IIC	PLE-9500-2-DL-ICR
PLE-9500-1-DL-III	PLE-9500-2-DL-III
PLE-9500-1-DL-IIR	PLE-9500-2-DL-IIR
PLE-9500-1-DL-IRC	PLE-9500-2-DL-IRC
PLE-9500-1-DL-IRI	PLE-9500-2-DL-IRI
PLE-9500-1-DL-IRR	PLE-9500-2-DL-IRR
PLE-9500-1-DL-RCC	PLE-9500-2-DL-RCC
PLE-9500-1-DL-RCI	PLE-9500-2-DL-RCI
PLE-9500-1-DL-RCR	PLE-9500-2-DL-RCR
PLE-9500-1-DL-RIC	PLE-9500-2-DL-RIC
PLE-9500-1-DL-RII	PLE-9500-2-DL-RII
PLE-9500-1-DL-RIR	PLE-9500-2-DL-RIR
PLE-9500-1-DL-RRC	PLE-9500-2-DL-RRC
PLE-9500-1-DL-RRI	PLE-9500-2-DL-RRI
PLE-9500-1-DL-RRR	PLE-9500-2-DL-RRR