

Manitowoc®

INDIGO[®] NXT

**QuietQube Remote Condensing Unit
Ice Machines**

Technician's Handbook



Safety Notices

Read these precautions to prevent personal injury:

- Read this manual thoroughly before operating, installing or performing maintenance on the equipment. Failure to follow instructions in this manual can cause property damage, injury or death.
- Routine adjustments and maintenance procedures outlined in this manual are not covered by the warranty.
- Proper installation, care and maintenance are essential for maximum performance and trouble-free operation of your equipment.
- Visit our website www.manitowocice.com for manual updates, translations, or contact information for service agents in your area.
- This equipment uses high voltage electricity and contains refrigerant charge. Installation and repairs are to be performed by properly trained technicians aware of the dangers of dealing with high voltage electricity and refrigerant under pressure. The technician must also be certified in proper refrigerant handling and servicing procedures. All lockout and tag out procedures must be followed when working on this equipment.
- As you work on this equipment, be sure to pay close attention to the safety notices in this handbook. Disregarding the notices may lead to serious injury and/or damage to the equipment.

DEFINITIONS

DANGER

Indicates a hazardous situation that, if not avoided, will result in death or serious injury. This applies to the most extreme situations.

Warning

Indicates a hazardous situation that, if not avoided, could result in death or serious injury.

Caution

Indicates a hazardous situation that, if not avoided, could result in minor or moderate injury.

Notice

Indicates information considered important, but not hazard-related (e.g. messages relating to property damage).

NOTE: Indicates useful, extra information about the procedure you are performing.

Warning

Follow these electrical requirements during installation of this equipment:

- All field wiring must conform to all applicable codes of the authority having jurisdiction. It is the responsibility of the end user to provide the disconnect means to satisfy local codes. Refer to rating plate for proper voltage.
- This appliance must be grounded.
- This equipment must be positioned so that the plug is accessible unless other means for disconnection from the power supply (e.g., circuit breaker or disconnect switch) is provided.
- Check all wiring connections, including factory terminals, before operation. Connections can become loose during shipment and installation.

Warning

Follow these precautions to prevent personal injury during installation of this equipment:

- Installation must comply with all applicable equipment fire and health codes with the authority having jurisdiction.
- Connect to a potable water supply only.
- To avoid instability the installation area must be capable of supporting the combined weight of the equipment and product. Additionally the equipment must be level side to side and front to back.
- Remove all removable panels before lifting and installing and use appropriate safety equipment during installation and servicing. Two or more people are required to lift or move this appliance to prevent tipping and/or injury.
- Do not damage the refrigeration circuit when installing, maintaining or servicing the unit.
- This equipment contains refrigerant charge. Installation of the line sets must be performed by a properly trained and EPA certified refrigeration technician aware of the dangers of dealing with refrigerant charged equipment.
- Ice machines require a deflector when installed on an ice storage bin. Prior to using a non-OEM ice storage system with this ice machine, contact the bin manufacturer to assure their ice deflector is compatible.
- Prior to installing a non-OEM ice storage system with this ice machine, follow the manufacturers installation procedures and verify the location and installation meets the local/national mechanical codes and stability requirements.

Warning

Follow these precautions to prevent personal injury while operating or maintaining this equipment:

- Legs or casters must be installed and the legs/casters must be screwed in completely. When casters are installed the mass of this unit will allow it to move uncontrolled on an inclined surface. These units must be tethered/secured to comply with all applicable codes. Swivel casters must be mounted on the front and rigid casters must be mounted on the rear. Lock the front casters after installation is complete.
- Refer to nameplate to identify the type of refrigerant in your equipment.
- Only trained and qualified personnel aware of the dangers are allowed to work on the equipment.
- Read this manual thoroughly before operating, installing or performing maintenance on the equipment. Failure to follow instructions in this manual can cause property damage, injury or death.
- Crush/Pinch Hazard. Keep hands clear of moving components. Components can move without warning unless power is disconnected and all potential energy is removed.
- Moisture collecting on the floor will create a slippery surface. Clean up any water on the floor immediately to prevent a slip hazard.

Warning

Follow these precautions to prevent personal injury while operating or maintaining this equipment:

- Objects placed or dropped in the bin can affect human health and safety. Locate and remove any objects immediately.
- Never use sharp objects or tools to remove ice or frost.
- Do not use mechanical devices or other means to accelerate the defrosting process.
- When using cleaning fluids or chemicals, rubber gloves and eye protection (and/or face shield) must be worn.

DANGER

Do not operate equipment that has been misused, abused, neglected, damaged, or altered/modified from that of original manufactured specifications. This appliance is not intended for use by persons (including children) with reduced physical, sensory or mental capabilities, or lack of experience and knowledge, unless they have been given supervision concerning use of the appliance by a person responsible for their safety. Do not allow children to play with, clean or maintain this appliance without proper supervision.

DANGER

Follow these precautions to prevent personal injury during use and maintenance of this equipment:

- It is the responsibility of the equipment owner to perform a Personal Protective Equipment Hazard Assessment to ensure adequate protection during maintenance procedures.
- Do Not Store Or Use Gasoline Or Other Flammable Vapors Or Liquids In The Vicinity Of This Or Any Other Appliance. Never use flammable oil soaked cloths or combustible cleaning solutions for cleaning.
- All covers and access panels must be in place and properly secured when operating this equipment.
- Risk of fire/shock. All minimum clearances must be maintained. Do not obstruct vents or openings.
- Failure to disconnect power at the main power supply disconnect could result in serious injury or death. The power switch DOES NOT disconnect all incoming power.
- All utility connections and fixtures must be maintained in accordance with the authority having jurisdiction.
- Turn off and lockout all utilities (gas, electric, water) according to approved practices during maintenance or servicing.
- Units with two power cords must be plugged into individual branch circuits. During movement, cleaning or repair it is necessary to unplug both power cords.

Warning

Follow these precautions to prevent personal injury while operating or maintaining this equipment.

- Refer to nameplate to identify the type of refrigerant in your equipment.
- Only trained and qualified personnel aware of the dangers are allowed to work on the equipment.
- Read this manual thoroughly before operating, installing or performing maintenance on the equipment. Failure to follow instructions in this manual can cause property damage, injury or death.
- Crush/Pinch Hazard. Keep hands clear of moving components. Components can move without warning unless power is disconnected and all potential energy is removed.
- Moisture collecting on the floor will create a slippery surface. Clean up any water on the floor immediately to prevent a slip hazard.
- Never use sharp objects or tools to remove ice or frost. Do not use mechanical devices or other means to accelerate the defrosting process.
- When using cleaning fluids or chemicals, rubber gloves and eye protection (and/or face shield) must be worn.

Warning

Follow these precautions to prevent personal injury during use and maintenance of this equipment:

- Units with two power cords must be plugged into individual branch circuits. During movement, cleaning or repair it is necessary to unplug both power cords.
- Never use a high-pressure water jet for cleaning on the interior or exterior of this unit. Do not use power cleaning equipment, steel wool, scrapers or wire brushes on stainless steel or painted surfaces.
- Two or more people are required to move this equipment to prevent tipping.
- Locking the front casters after moving is the owner's and operator's responsibility. When casters are installed, the mass of this unit will allow it to move uncontrolled on an inclined surface. These units must be tethered/secured to comply with all applicable codes.
- The on-site supervisor is responsible for ensuring that operators are made aware of the inherent dangers of operating this equipment.
- Do not operate any appliance with a damaged cord or plug. All repairs must be performed by a qualified service company.

THIS PAGE INTENTIONALLY LEFT BLANK

Table of Contents

Safety Notices	3
Definitions	4
General Information	
Model Numbers	19
QuietQube® Models	19
How to Read a Model Number	20
Head Sections	20
CVD Condensing Units	21
Ice Cube Sizes	21
Model/Serial Number Location	22
Warranty	23
Warranty Registration	23
LuminIce® II	24
Home Screen - LuminIce Icon 	24
Installation	
Stacking Two Ice Machines on a Single Storage Bin.	25
Ice Deflector	25
Front Panel Removal	26
Hinged panel models	26
Location of Ice Machine	27
Head Section	27
Ice Beverage Models	28
Location of CVD Condensing Units	29
Clearance Requirements	30
Dual Evaporator Model Installation on a Manitowoc Bin	31
Ice Machine on a Dispenser Installation	32
Water Supply and Drains	33
Lineset Applications	34
QuietQube® Remote Condensing Unit	35
R-404A	35
R-410A	35
Maintenance	
Detailed De-scaling and Sanitizing	39
General	39

Detailed De-scaling/Sanitizing Procedure . . .	40
Remedial De-scaling Procedure	40
iAuCS®	40
Exterior Cleaning	40
Touchscreen Operation For The Clean Cycle . . .	41
Starting a Clean cycle	41
Water curtain/damper operation during the clean cycle	41
Pausing a clean cycle	41
Power interruption during clean cycle	41
Aborting a clean cycle	41
Detailed De-scaling/Sanitizing Procedure	42
Sanitizing Procedure	45
Parts Removal for De-scaling/Sanitizing	47
Remedial De-scaling Procedure	56
Removal from Service/Winterization	58

Operation

Touchscreen Features	59
Home screen icon descriptions	61
Setup Wizard	63
Menu Navigation Overview	64
Settings Menu Screen Navigation	64
Operational Checks	69
General	69
Ice Thickness Check	70
Sequence of Operation	72
QuietQube® Models	72
Initial Start-Up or Start-Up After Automatic Shut-Off	72
Freeze Sequence	73
Harvest Sequence	75
Automatic Shut-Off	76
Restart After Automatic Shut-off	76

Troubleshooting

Troubleshooting	81
Alert Log	82
Alert Log Detail	83
Thaw Cycle	88
Safe Operation Mode	89
E01 Long Freeze Cycle	90

E02 Long Harvest Cycle	90
Analyzing Why A Service Fault (E01 & E02)	
Stopped the Ice Machine	90
E01 Long Freeze.	91
E02 Long Harvest.	93
Troubleshooting By Symptom	94
Symptom #1 Ice Machine Stops Running	94
Symptom #2 Ice Machine has a Long Freeze Cycle	94
Symptom #3 Will not harvest, cubes normal	94
Symptom #4 Will not harvest cubes melted	94
Reset To Factory Defaults	95
Symptom #1 Ice Machine Will Not Run.	96
Diagnosing a Condensing Unit That Will Not Run	99
Symptom #2 Low Production, Long Freeze Cycle 100	
Symptom #3 Harvest Problems	116
Failure Type and Symptoms:	119
Symptom #3 ICE MACHINE WILL NOT HARVEST - FREEZE CYCLE NORMAL, CUBES ARE NOT MELTED	121
Symptom #4 Ice Machine Will Not Harvest - Freeze Cycle Is Normal and Ice Cubes Are Melted After Harvest	125

Component Check Procedures

Control Board, Display And Touchscreen	127
Control Board Relay Test.	130
Programming A Replacement Control Board	131
USB Flash Drive Specifications and Formatting	132
Exporting Data to a Flash Drive	133
Upgrading Firmware with a Flash Drive	134
Main Fuse	135
Bin Switch	136
Water Level Control Circuitry	139
Ice Thickness Probe (Initiates Harvest)	143
Bin Level Probe	148
Thermistors	150
High Pressure Cutout (HPCO) Control	153

Low Pressure Cutout (LPCO) Control	154
Compressor Time Delay	155
Fan Cycle Control.	156
Harvest Assist Air Pump	157
Compressor Electrical Diagnostics	158
Diagnosing Start Components	160
Refrigeration Components.	161
Head Pressure Control Valve	161
Suction Accumulator Operation.	167
Recovery/Evacuation/Charging Procedures	
QuietQube® Models	168
Connections.	169
Recovery/Evacuation Procedures	170
Charging Procedures.	171
System Contamination Clean-Up	172
Determining Severity of Contamination	172
Contamination Clean-up Chart.	173
Clean-up Procedure	174
Liquid Line Filter-Driers.	177
Suction Filter	177
Replacing Pressure Controls Without Removing Refrigerant Charge	178
Total System Refrigerant Charge	
QuietQube® CVD Models.	179

Charts

Cycle Times/24-Hour Ice Production/Refrigerant Pressure Charts	181
IF0600C/CVDF0600	182
IBF0620C/CVDF0600	183
IBF0820C/CVDF0900	184
IF0900C/CVDF0900	185
IBT1020C/CVDT1200	186
IT1200C/CVDT1200	187
IF1400C/CVDF1400	188
IT1430C/CVDT1400	189
IF1800C/CVDF1800	190
IT1830C/CVDT1800	191
IF2100C/CVDF2100	192
IT2130C/CVDT2100	193

Diagrams

Wiring Diagrams	195
Wiring Diagram Legend	195
IF0600C/IBF0620C/IBF0820C/IF0900C 1ph .196	
IT1200C/IBT1020C 1ph	198
IF1400C/IF1800C/IF2100C 1ph	200
IT1430C/IT1830C/IT2130C 1ph	202
IT1430C/IT1830C/IT2130C 1ph	203
CVD 1ph Condensing Unit with Delay Relay	204
CVD 1ph Condensing Unit without Delay Relay	206
CVD 3ph Condensing Unit with Delay Relay	208
CVD 3ph Condensing Unit without Delay Relay	210
Electronic Control Board	212
Refrigeration Tubing Schematics	214
IF0600C/CVDF0600 IB0620C/CVDF0600 IBF0820/CVDF0900 IF0900C/CVDF0900 . . .	214
IBT1020C/CVDT1200 IT1200C/CVDT1200 . .	216
Dual Evaporators	218
IF1400C/IF1800C	218
IF2100C	220

THIS PAGE INTENTIONALLY LEFT BLANK

General Information

Model Numbers

QUIETQUBE® MODELS

Ice Machine Head Section	CVD® Condensing Unit
IYF0600C IBF0620C	CVDF0600
IBF0820C IYF0900C	CVDF0900
IBT1020C IDT1200C IYT1200C	CVDT1200
IDF1400C IYF1400C	CVDF1400
IDT1430C IYT1430C	CVDT1400
IDF1800C IYF1800C	CVDF1800
IDT1830C IYT1830C	CVDT1800
IDF2100C IYF2100C	CVDF2100
IDT2130C IYT2130C	CVDT2100

NOTE: Additional designators identify Voltage, Specials or Country specific models. See “Model Nomenclature” on next page.

Warning

All Manitowoc ice machines require the ice storage system (bin, dispenser, etc.) to incorporate an ice deflector.

Prior to using a non-Manitowoc ice storage system with other Manitowoc ice machines, contact the manufacturer to assure their ice deflector is compatible with Manitowoc ice machines.

How to Read a Model Number

HEAD SECTIONS

POWER CORD OPTION	Blank	junction box
	Z	cord without plug
	B	NEMA plug (USA)
	F	schuko plug (EU)
	G	13A blade (GBR)
	I (AUS)	oblique V blades
SPECIAL USE	A	alternate compressor
	Blank	general use
	Q	coated condenser
	H	high pressure
	M	marine
	P	correctional
	T	top air discharge
	X	Luminice® /Sanitation
	L	lever
	V	spacemaker
MARKET IDENTIFIER	Blank	not market specific
	S	Saudi Arabia (GCC)
	K	Korea (KC)
	C	China (CCC)
	D	Germany (GS)
	N	Brazil (InMetro)

ELECTRICAL CONFIGURATION

161 = 115/60/1
261 = 208-230/60/1
251 = 220-240/50/1 (S=230)
263 = 208-230/60/3
271 = 200/50-60/1
273 = 200/50-60/3
453 = 380-415/50/3
463 = 460/60/3

REFRIGERANT TYPE

P	R290 (propane)
F	R404A (four)
T	R410A (ten)
B	R600A (butane)
E	R134A (eight)

ICE TYPE

R	Regular
D	Dice
Y	Half-dice
F	Flake
N	Nugget
G	Gourmet
Blank	for IB only

I Y T 1 2 0 0 C - 2 6 1 X

ICE MACHINE SERIES

I	Indigo®
U	Undercounter
K	Koolaire
R	Flake/Nugget
B	Big shot
S	S-series
IB	Ice Beverage
C	Countertop

NOMINAL PRODUCTION @ 70/50

0300	produces ~300 #/day
0320	produces ~320 #/day
0350	produces ~350 #/day
etc. . .	
Sotto is stated in kg/day	

CONDENSER TYPE

A	air cooled
W	water cooled
N	remote (traditional)
C	CVD (remote)

CVD CONDENSING UNITS

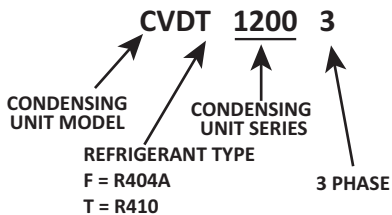

Ice Cube Sizes

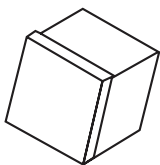

Regular

1-1/8" x 1-1/8" x 7/8"
2.86 x 2.86 x 2.22 cm

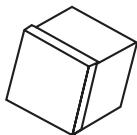

Dice

7/8" x 7/8" x 7/8"
2.22 x 2.22 x 2.22 cm

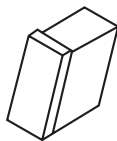

Half Dice

3/8" x 1-1/8" x 7/8"
0.95 x 2.86 x 2.22 cm

Model/Serial Number Location

These numbers are required when requesting information from your local Manitowoc Distributor, service representative, or Manitowoc Ice, Inc.

- The model and serial number can be viewed by pressing the information icon on the touchscreen.
- The owner warranty registration card.
- The model/serial number data plate located in the evaporator compartment and on the back of the ice machine.

The model and serial number displayed on the touchscreen must match the data plate for proper operation. For example a model number listed on the data plate may show IDT1200C-161X but the display would only show IDT1200C-161.

Warranty

For warranty information visit:

www.manitowocice.com/Service/Warranty

- Warranty Coverage Information
- Warranty Registration
- Warranty Verification

Warranty coverage begins the day the ice machine is installed.

WARRANTY REGISTRATION

Completing the warranty registration process is a quick and easy way to protect your investment.

Scan the QR code with your smart device or enter the link in a web browser to complete your warranty registration.



WWW.MANITOWOCICE.COM/SERVICE/WARRANTY#WARRANTY-REGISTRATION

Registering your product insures warranty coverage and streamlines the process if any warranty work is required.

LuminIce® II

The LuminIce® growth inhibitor recirculates the air in the ice machine foodzone over a UV bulb. This process will inhibit the growth of common micro-organisms on all exposed foodzone surfaces.

- LuminIce® bulbs require replacement on a yearly basis.
- The control board can be set to automatically display a reminder after 12 months.

NOTE: LuminIce® and LuminIce® II bulbs are not interchangeable; verify your model before ordering a replacement bulb. LuminIce® bulbs have a white base and LuminIce® II bulbs have a blue base.

HOME SCREEN - LUMINICE ICON



- A blue icon: Normal Operation.
- A red icon: Bulb Replacement is required.
- Flashing Red/Blue icon: Incorrect bulb is installed.
- Flashing Red icon: Replace the LuminIce module.

Cleanup Procedure for Accidental Bulb Breakage

The cleanup procedure is identical to the procedure used to clean up compact fluorescent (CFL) or fluorescent tube lights. These lights contain a small amount of mercury sealed within a glass tube. Breaking these types of lights will release mercury and mercury vapor. The broken bulb can continue to release mercury vapor until it is cleaned up and removed.

The latest EPA procedures can be viewed on their website at www.epa.gov/cfl/cflcleanup.html.

NOTE: LuminIce® and LuminIce® II bulbs are not interchangeable; verify your model before ordering a replacement bulb. LuminIce® bulbs have a white base and LuminIce® II bulbs have a blue base.

Installation

Warning

PERSONAL INJURY POTENTIAL

Remove all ice machine panels before lifting.

Notice

IF1400C/IT1430C/IF1800C/IT1830C/IF2100C/IT2130C ice machines are not approved for use on Manitowoc D570 bins.

Notice

The ice machine head section must be protected if it will be subjected to temperatures below 32°F (0°C). Failure caused by exposure to freezing temperatures is not covered by the warranty.

STACKING TWO ICE MACHINES ON A SINGLE STORAGE BIN

Indigo® Model ice machines cannot be stacked. However an adapter is available that allows two QuietQube® ice machines to be placed side by side on 60" bins.

ICE DEFLECTOR

An ice deflector is required for all ice machines installed on a bin and may be required by the dispenser manufacture when installed on a dispenser.

Front Panel Removal

HINGED PANEL MODELS

Warning

PERSONAL INJURY POTENTIAL

Follow all steps for removing and reinstalling the front panel. Failure to follow these steps, leaving off parts, or overtightening screws, can lead to the panel falling off and result in injury and property damage. The panel is heavy.

Caution

It is a UL requirement to properly install ALL panel screws. Only remove screws from one side of the ice machine at a time.

Lifting Hazard: A single person removal could cause injury or unit damage. Always have assistance when handling, removing or lifting panels. While handling, grasp firmly to ensure the panel does not fall or scratch the finish.

Keep fingers out of “pinch point” areas; clearances between the panel and between the panel and ice machine cabinet are small.

Step 1 Use a #2 Phillips screwdriver to loosen the two screws securing the front panel. Do not remove they are secured to prevent loss.

Step 2 Open front panel.

Step 3 Support with right hand, depress top pin, tilt top of panel forward and lift straight up off of the bottom pin to remove. Place panels on a protected surface.

Step 4 When reinstalling, once top pin is reengaged, hold the panel firmly against the ice machine. Verify there are no gaps and fully tighten the screws.

Location of Ice Machine

HEAD SECTION

The location selected for the ice machine head section must meet the following criteria. If any of these criteria are not met, select another location.

- The location must be indoors and free of airborne and other contaminants.
- The air temperature must be at least 35°F (1.6°C), but must not exceed 110°F (43°C).
- Ice Making Water Inlet - Water Pressure must be at least 20 psi (1.4 bar), but must not exceed 80 psi (5.5 bar).
- The location must not be near heat-generating equipment or in direct sunlight and protected from weather.
- The location must allow enough clearance for water, drain, and electrical connections in the **rear of the ice machine**.
- The ice machine must be protected if it will be subjected to temperatures below 32°F (0°C). Failure caused by exposure to freezing temperatures is not covered by the warranty.

ICE BEVERAGE MODELS

- Ice/Beverage Ice Machines require that a proper ice level be maintained when installed on a dispenser. Ice Beverage machines ship with a ice level management sensor pre-installed.
- The ice machine head is installed with the electrical inlet, water supply inlet, refrigeration tubing and water drain entering from the back of the ice machine.
- The ice machine head section contains a service loop that must remain installed between the ice machine head section and line set. Sufficient tubing length must be available to allow 180° rotation of the ice machine.
- Maintain a 3" space between the back of the ice machine and the back of the dispenser to allow room for the refrigeration line set service loop.
- The water inlet and electrical connection must contain a service loop to allow future service and maintenance access.
- The drain line must contain a union or other suitable means of disconnection at the ice machine head section.
- The location must be free of airborne and other contaminants.
- The air temperature must be at least 35°F (1.6°C), but must not exceed 110°F (43°C).
- The location must not be near heat-generating equipment or in direct sunlight and protected from weather.

LOCATION OF CVD CONDENSING UNITS

The location selected for the CVD Condensing Unit must meet the following criteria. If any of these criteria are not met, select another location.

- The air temperature must be at least -20°F (-28.9°C) but must not exceed 120°F (48.9°C).
- The location must not allow exhaust fan heat and/or grease to enter the condenser.
- The location must not obstruct airflow through or around the condensing unit. See below for clearance requirements.

Minimum/Maximum Temperatures

Model	Minimum Air Temperature	Maximum Air Temperature
All Ice Machine Head Sections	35°F 2°C	110°F 43°C
All Models	-20°F -29°C	120°F 49°C
QuietQube Condensing Units		
CVDF0600 CVDF0900 CVDT1200 CVDF2100 CVDT2100	-20°F -29°C	120°F 49°C
CVDF1400 CVDT1400 CVDF1800 CVDT1800	-20°F -29°C	130°F 54°C

Clearance Requirements

QuietQube Model Clearance Requirements

Model	Top	Back	Sides
IF0600C IF0900C IT1200C	5" (13 cm)	5" (13 cm)	5" (13 cm)
IBF0620C IBF0820C IBT1020C IF1400C IT1430C IF1800C IT1830C IF2100C IT2130C	2"*** (5 cm)	5" (13 cm)	8" ** (20 cm)
** 24" (61 cm) is recommended on top/sides for servicing			

Condensing Unit Clearance Requirements

Model	Top/Sides	Back	Front
CVDF0600 CVDF0900 CVDT1200 CVDF1400 CVDT1400 CVDF1800 CVDT1800 CVDF2100 CVDT2100	0" (0 cm*)	48" (122 cm)	48" (122 cm)
* 24" (61 cm) is recommended on top/sides for servicing			

Dual Evaporator Model Installation on a Manitowoc Bin

Dual evaporator models will not function correctly with the stock bin deflector. An ice deflector kit is required for installation and is ordered separate. Order appropriate kit (30" or 48") for your bin.

The stock bin deflector must be removed and replaced with the correct deflector to prevent injury.

Warning

PERSONAL INJURY POTENTIAL

Do not operate any ice machine with the deflector removed.

NOTE: A deflector must be installed on all dual evaporator models used in bin applications.

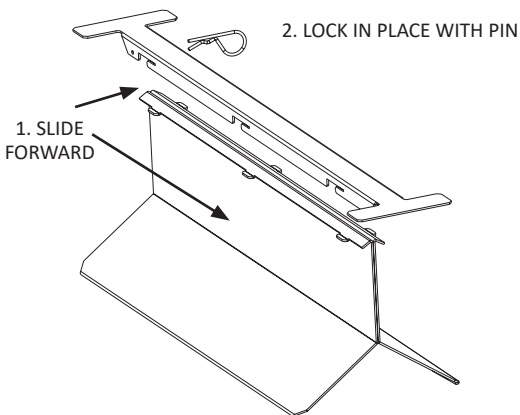

Ice Machine on a Dispenser Installation

No deflector is needed for machines that match the size of the dispenser (30" head section on a 30" dispenser) unless required by the dispenser manufacturer.

Adapters are required when a smaller ice machine is going on a larger dispenser (22" machine on a 30" dispenser).

Ice level management is recommended to prevent water leakage or movement of ice machine during agitation.

A dispenser baffle is required to prevent ice from contacting the ice machine panel and prevent possible water leakage. K00348 is used on 22" ice machines and K00346 is used on 30" ice machines.

Important

Manitowoc ice beverage ice machines require an adapter for mounting. Adapters are not included with the ice machine, dispenser or bin and must be ordered separately. When a non-Manitowoc adapter is used, verify the adapter is compatible with Manitowoc Ice/Beverage Ice Machines prior to installation.

Warning

Ice Beverage ice machines, adapter plates and adapter covers must be secured to the dispenser to prevent tipping or dislodging during agitation.

Water Supply and Drains

Potable Water

- Water temperature must be between 40°F (4.4°C) and 90°F (32°C).
- Water pressure must be between 20 psi (140 kPa) and 80 psi (550 kPa).
- Minimum internal diameter of tubing 3/8" (10 mm).

Drain Connections

- Drain lines must have a 1.5 inch drop per 5 feet (2.5 cm per meter) of run and must not create traps.
- The floor drain must be large enough to accommodate drainage from all drains.
- Run separate bin and ice machine drain lines.
- Insulate drain lines to prevent condensation.
- Vent the ice machine drain to the atmosphere.
- Drain termination must have an air gap that meets local code.

Auxiliary Base Drain Installation

An auxiliary drain is located in the ice machine base to remove moisture in high humidity areas.

1. View the back of the ice machine base on the compressor side and locate and remove the cap plug.
2. Route tubing to an open site drain:
 - Use 1/2 inch ID CPVC tubing.
 - Apply a bead of silicone around the exterior of the ice machine tubing and insert into ice machine base. The silicone will secure the tubing and provide a watertight seal.
 - Provide support for tubing.

Lineset Applications

Notice

The 60-month compressor warranty (including the 36-month labor replacement warranty) will not apply if the Manitowoc Ice Machine, Condenser or QuietQube® Condensing Unit were not installed according to specifications. This warranty also will not apply if the refrigeration system is modified with a condenser, heat reclaim device, or other parts or assemblies not manufactured by Manitowoc Ice. Or refrigeration system additives such as leak detection dyes, inhibitors or non OEM approved chemicals.

Warning

Recovery locations vary by model. Verify you are making the correct connections for your model to prevent accidental release of high pressure refrigerant.

Important

Manitowoc remote systems are only approved and warranted as a complete new package. Warranty on the refrigeration system will be void if new equipment is connected to pre-existing (used) tubing, remote condenser, remote condensing unit or ice machine head section.

QuietQube® Remote Condensing Unit

R-404A

QuietQube® Ice Machine	Remote Single Circuit Condenser	Line Set*	S Trap
IF0600C IBF0620C	CVDF0600	RC-21 RC-31	K00172 5/8 inch (16 mm)
IBF0820C IF0900C	CVDF0900	RC-51	
IF1400C	CVDF1400	RC-20	K00166 3/4 inch (19 mm)
IF1800C	CVDF1800	RC-30 RC-50	
IF2100C	CVDF2100	RC-23 RC-33 RC-53	

R-410A

QuietQube® Ice Machine	Remote Single Circuit Condenser	Line Set*	S Trap
IBT1020C	CVDT1200	RC-21	K00172 5/8 inch (16 mm)
IT1200C	CVDT1200	RC-31	
IT1430C	CVDT1400	RC-51	
IT1830C	CVDT1800	RC-20 RC-30 RC-50	K00166 3/4 inch (19 mm)
IT2130C	CVDT2100		

*Line Set	Suction Line	Liquid Line	Minimum Insulation Thickness
RC 21/31/51	5/8 inch (16 mm)	3/8 inch (10 mm)	1/2" (13 mm) Suction Line 1/4" (7 mm) Liquid Line
RC 20/30/50	3/4 inch (19 mm)	1/2 inch (13 mm)	1/2" (13 mm) Suction Line 1/4" (7 mm) Liquid Line
RC 23/33/53	3/4 inch (19 mm)	5/8 inch (16 mm)	1/2" (13 mm) Suction Line 1/4" (7 mm) Liquid Line

* All line sets must be insulated.

Additional Refrigerant Charge For 51' to 100' Line Sets

Ice Machine	Condenser	Additional Amount of Refrigerant To Be Added To Nameplate Charge
IF0600C	CVDF0600	1.5 lbs
IBF0620C		680 g
IBF0820C	CVDF0900	2 lbs
IF0900C		907 g
IBT1020C	CVDT1200	2 lbs
		907 g
IT1200C		2 lbs
		907 g
IF1400C	CVDF1400	2 lbs
		907 g
IT1430C	CVDT1400	2 lbs
		907 g
IF1800C	CVDF1800	2 lbs
		907 g
IT1830C	CVDT1800	2 lbs
		907 g
IF2100C	CVDF2100	4 lbs
		1814 g
IT2130C	CVDT2100	2 lbs
		907 g

Calculating Allowable Lineset Distance

Line Set Length

The maximum length is 100' (30.5 m).

Line Set Rise/Drop

The maximum rise is 35' (10.7 m).

The maximum drop is 15' (4.5 m).

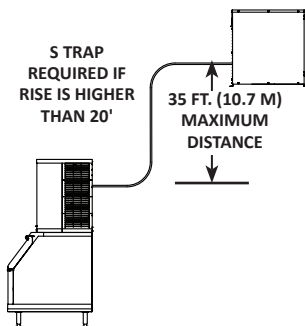

35 ft. (10.7 m) Rise: The maximum distance the Condenser or Condensing Unit can be above the ice machine.

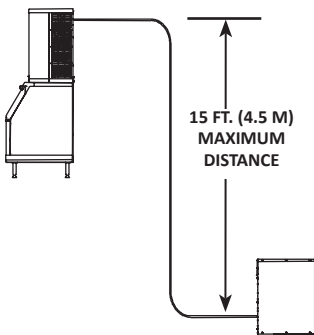

15 ft. (4.5 m) Drop: The maximum distance the Condenser or Condensing Unit can be below the ice machine.

If a line set has a rise followed by a drop, another rise cannot be made. Likewise, if a line set has a drop followed by a rise, another drop cannot be made.

THIS PAGE INTENTIONALLY LEFT BLANK

Maintenance

Detailed De-scaling and Sanitizing

GENERAL

You are responsible for maintaining the ice machine in accordance with the instructions in this manual. Maintenance procedures are not covered by the warranty.

De-scale and sanitize the ice machine every six months for efficient operation. If the ice machine requires more frequent de-scaling and sanitizing, consult a qualified service company to test the water quality and recommend appropriate water treatment. An extremely dirty ice machine must be taken apart for de-scaling and sanitizing.

Manitowoc Ice Machine De-scaler and Sanitizer are the only products approved for use in Manitowoc ice machines.

Caution

Use only Manitowoc approved Ice Machine De-scaler and Sanitizer for this application (Manitowoc De-scaler part number 9405463 and Manitowoc Sanitizer part number 9405653). It is a violation of Federal law to use these solutions in a manner inconsistent with their labeling. Read and understand all labels printed on bottles before use.

Caution

Do not mix De-scaler and Sanitizer solutions together. It is a violation of Federal law to use these solutions in a manner inconsistent with their labeling.

Warning

Wear rubber gloves and safety goggles (and/or face shield) when handling Ice Machine De-scaler or Sanitizer.

DETAILED DE-SCALING/SANITIZING PROCEDURE

This procedure must be performed a minimum of once every six months.

- The ice machine and bin must be disassembled de-scaled and sanitized.
- All ice produced during the de-scaling and sanitizing procedures must be discarded.

REMEDIAL DE-SCALING PROCEDURE

- This procedure de-scales the components in the water flow path, and is used to de-scale the ice machine between the bi-yearly detailed de-scaling/sanitizing procedure.

IAUCS®

iAuCS® does not operate when Clean is selected to start a Clean cycle. To prime the hose activation is required through the Service Menu/iAuCS® icon.

EXTERIOR CLEANING

Clean the area around the ice machine as often as necessary to maintain cleanliness and efficient operation.

Wipe surfaces with a damp cloth rinsed in water to remove dust and dirt from the outside of the ice machine. If a greasy residue persists, use a damp cloth rinsed in a mild dish soap and water solution. Wipe dry with a clean, soft cloth.

The exterior panels have a clear coating that is stain resistant and easy to clean. Products containing abrasives will damage the coating and scratch the panels.

- Never use steel wool or abrasive pads for cleaning.
- Never use chlorinated, citrus based or abrasive cleaners on exterior panels and plastic trim pieces.

Touchscreen Operation For The Clean Cycle

STARTING A CLEAN CYCLE

Pressing the Clean button will display a Continue/Abort screen, and a warning that pressing Continue will result in a clean cycle that can last up to 35 minutes.

WATER CURTAIN/DAMPER OPERATION DURING THE CLEAN CYCLE

The water curtain/damper must remain closed during the de-scaling and sanitizing procedures. When the curtain/damper is open for more than 3 seconds the clean cycle stops and a message is displayed on the touchscreen with a choice to continue or stop the clean cycle. Stopping the clean cycle will result in a series of rinse and dump cycles to verify de-scaler or sanitizer has been removed before ice making.

PAUSING A CLEAN CYCLE

The clean cycle can be paused and resumed at any time by pressing the power button. The clean cycle will resume from the beginning of either the wash or rinse cycle depending on the point of interruption.

POWER INTERRUPTION DURING CLEAN CYCLE

If the power supply is interrupted during the clean cycle the state is retained in the circuit board. When power is reapplied the clean cycle will resume from the beginning of either the wash or rinse cycle depending on the point of interruption.

ABORTING A CLEAN CYCLE

Verify de-scaler or sanitizer are not present in the water system before aborting a clean cycle.

1. Press and hold the Clean button.
2. Press the Power button.
3. Release the Clean button.

Detailed De-scaling/Sanitizing Procedure

Caution

Do not mix De-scaler and Sanitizer solutions together. It is a violation of Federal law to use these solutions in a manner inconsistent with their labeling.

Warning

Wear rubber gloves and safety goggles (and/or face shield) when handling Ice Machine De-scaler or Sanitizer.

Ice machine des-calder is used to remove lime scale and mineral deposits. Ice machine sanitizer disinfects and removes algae and slime.

NOTE: Although not required and dependent on your installation, removing the ice machine top cover may allow easier access.

Step 1 Open the front panel to access the evaporator compartment. Ice must not be on the evaporator during the de-scaling/sanitize cycle. Follow one of the methods below:

- Press the power switch at the end of a harvest cycle after ice falls from the evaporator(s).
- Press the power switch and allow the ice to melt.
- Use the touchscreen to initiate a manual harvest cycle.

Notice

Never use anything to force ice from the evaporator. Damage may result.

Step 2 Remove all ice from the bin/dispenser.

Step 3 Press the Clean button and select “Turn off when complete.” Water will flow through the water dump valve and down the drain. Wait approximately 1 minute until the water trough refills and the display indicates Add Chemical. Add the proper amount of ice machine de-scaler to the water trough by pouring between the water curtain and evaporator, then confirm the chemical was added.

NOTE: There is a 10 minute time limit to confirm chemical was added.

- Confirmation is pushed within 10 minutes - The ice machine will start a 10 minute wash cycle, followed by 6 rinse and flush cycles.
- Confirmation is not pushed within 10 minutes - The ice machine will skip the 10 minute wash cycle and start 6 rinse and flush cycles.

Step 4

Model	Amount of De-scaler
IF0600C/IBF0620C/IBF0820C IF0900C/IBT1020C/IT1200C	5 ounces (150 ml)
IF1400C/IT1430C/IF1800C/ IT1830C/IF2100C/IT2130	9 ounces (265 ml)

Step 5 Wait until the cycle is complete, then disconnect power to the ice machine (and dispenser when used).

⚠ Warning

Disconnect the electric power to the ice machine at the electric service switch box.

Step 6 Remove parts for de-scaling.

Please refer to the proper parts removal for your ice machine. Continue with next step when the parts have been removed.

“Single Evaporator Ice Machines” on page 47

“Ice Beverage Ice Machines” on page 49

“Dual Evaporator Ice Machines” on page 51

Step 7 Mix a solution of de-scaler and lukewarm water. Depending upon the amount of mineral buildup, a larger quantity of solution may be required. Use the ratio in the table below to mix enough solution to thoroughly de-scale all parts.

Solution Type	Water	Mixed With
De-scaler	1 gal. (4 L)	16 oz (475ml) De-scaler

Step 8 Use 1/2 of the de-scaler/water mixture to de-scale all components. The solution will foam when it contacts lime scale and mineral deposits; once the foaming stops use a soft-bristle nylon brush, sponge or cloth (NOT a wire brush) to carefully de-scale the parts. Soak parts for 5 minutes (15 - 20 minutes for heavily scaled parts). Rinse all components with clean water.

Step 9 While components are soaking, use 1/2 of the de-scaler/water solution to de-scale all food zone surfaces of the ice machine and bin (or dispenser). Use a nylon brush or cloth to thoroughly de-scale the following ice machine areas:

- Side walls
- Base (area above water trough)
- Evaporator plastic parts - including top, bottom, and sides
- Bin or dispenser

Rinse all areas thoroughly with clean water.

SANITIZING PROCEDURE

Step 10 Mix a solution of sanitizer and lukewarm water.

Solution Type	Water	Mixed With
Sanitizer	3 gal. (12 L)	2 oz (60 ml) sanitizer

Step 11 Use 1/2 of the sanitizer/water solution to sanitize all removed components. Use a spray bottle to liberally apply the solution to all surfaces of the removed parts or soak the removed parts in the sanitizer/water solution. Do not rinse parts after sanitizing.

Step 12 Replace all removed components.

Step 13 Wait 20 minutes.

Step 14 Reapply power to the ice machine.

Step 15 Press the Clean button and select “Make ice when complete”. Water will flow through the water dump valve and down the drain. Wait approximately 1 minute until the water trough refills and the display indicates Add Chemical. Add the proper amount of ice machine sanitizer to the water trough by pouring between the water curtain and evaporator, then confirm the chemical was added.

Model	Amount of Sanitizer
IF0600C/IBF0620C/IBF0820C IF0900C/IBT1020C/IT1200C	3 ounces (90 ml)
IF1400C/IT1430C/IF1800C/ IT1830C/IF2100C/IT2130C	12 ounces (355 ml)

Step 16 The ice machine will automatically start ice making after the sanitize cycle is complete.

PARTS REMOVAL FOR DE-SCALING/SANITIZING

Single Evaporator Ice Machines

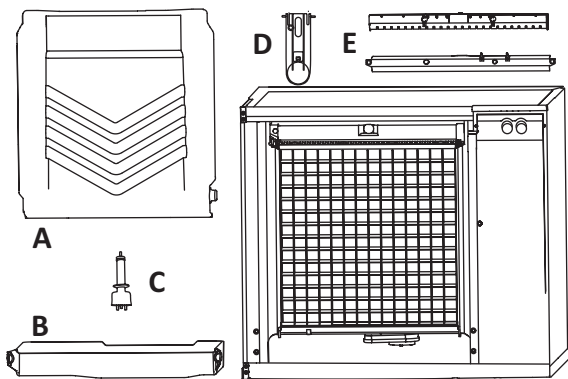

A. Remove the water curtain

- Gently flex the curtain in the center and remove it from the right side.
- Slide the left pin out.

B. Remove the water trough and water diverter from the bottom of the evaporator.

- Depress tabs on right and left side of the water trough.
- Allow front of water trough to drop as you pull forward to disengage the rear pins.
- Loosen thumbscrew on left side of water diverter tray.
- Allow left side of tray to drop as you pull the tray to the left to slide the right pin out.

C. Remove the water level probe

- Pull the water level probe straight down to disengage.
- Lower the water level probe until the wiring connector is visible.
- Disconnect the wire lead from the water level probe.
- Remove the water level probe from the ice machine.

D. Remove the ice thickness probe

- Compress the hinge pin on the top of the ice thickness probe.
- Pivot the ice thickness probe to disengage one pin then the other. The ice thickness probe can be de-scaled/sanitized at this point without complete removal. If complete removal is desired, disconnect the ice thickness control wiring from the control board.

E. Remove the water distribution tube

NOTE: Distribution tube thumbscrews are retained to prevent loss. Loosen thumbscrews but do not pull thumbscrews out of distribution tube.

- Loosen the two outer screws (do not remove screws completely they are retained to prevent loss) and pull forward on the distribution tube to release from slip joint.
- Disassemble distribution tube by loosening the two (2) middle thumbscrews and dividing the distribution tube into two pieces.

NOTE: Proceed to step 7 on page 44.

Ice Beverage Ice Machines

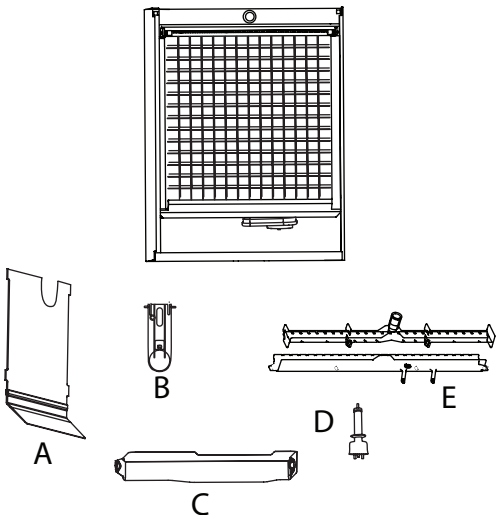

A. Remove splash shield

- Grasp the top center of splash shields.
- Lift up and then out.

B. Remove ice thickness probe

- Compress the hinge pin on the top of the ice thickness probe.
- Pivot the ice thickness probe to disengage one pin then the other. The ice thickness probe can be de-scaled/sanitized at this point without complete removal. If complete removal is desired, disconnect the ice thickness control wiring from the control board.

C. Remove the water trough

- Depress tabs on right and left side of the water trough.
- Allow front of water trough to drop as you pull forward to disengage the rear pins.

D. Remove the water level probe

- Pull the water level probe straight down to disengage.
- Lower the water level probe until the wiring connector is visible.
- Disconnect the wire lead from the water level probe.
- Remove the water level probe from the ice machine.

E. Remove the water distribution tube

NOTE: Distribution tube thumbscrews are retained to prevent loss. Loosen thumbscrews but do not pull thumbscrews out of distribution tube.

- Loosen the two outer screws (do not remove screws completely they are retained to prevent loss) and pull forward on the distribution tube to release from slip joint.
- Disassemble distribution tube by loosening the two (2) middle thumbscrews and dividing the distribution tube into two pieces

NOTE: Proceed to step 7 on page 44.

Dual Evaporator Ice Machines

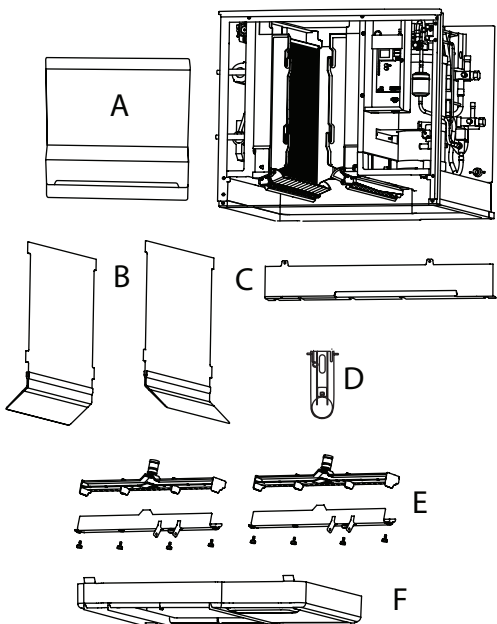

A. Remove front splash shield

- Grasp the top of the splash shield.
- Lift up and then out.

B. Remove evaporator splash shields

- Grasp the top center of splash shields.
- Lift up and then out.

C. Remove the water trough shield

- Grasp the water trough shield in the center and the left end.
- Flex the water trough shield in the center and pull the left end forward until clear of the side wall. Repeat for the right end.
- Pull water trough shield forward to remove.

D. Remove ice thickness probe

- Compress the hinge pin on the top of the ice thickness probe.
- Pivot the ice thickness probe to disengage one pin then the other. The ice thickness probe can be de-scaled/sanitized at this point without complete removal. If complete removal is desired, disconnect the ice thickness control wiring from the control board.

E. Remove ice dampers

- Grasp ice damper and apply pressure toward the back mounting bracket.
- Apply pressure to the front mounting bracket with thumb.
- Pull ice damper downward when the front ice damper pin disengages.

F. Remove the water pump assembly

- Disconnect the vinyl distribution tube from the water pump.
- Disconnect the water pump and water level probe electrical connections.
- After the wires are disconnected, remove the two thumbscrews and lift the water pump assembly out of the ice machine.
- Depress tabs, lift and remove water pump. Do not immerse the water pump motor in de-scaler or sanitizer solutions.
- Remove the water level probe from the assembly housing.

G. Remove distribution tubes

- Distribution tubes thumbscrews are retained to prevent loss. Loosen thumbscrews but do not pull thumbscrews out of distribution tube.
- Loosen the two outer screws and pull forward on the distribution tube to release from slip joint.
- Disassemble distribution tube by loosening the two (2) middle thumbscrews and dividing the distribution tube into two pieces.

H. Remove the water trough

- Depress the two tabs on the top of the water trough.
- Turn left and right ice dampers down to clear water trough.
- Pull forward on the water trough to remove.

NOTE: Proceed to page 44 Step 7.

Ice Thickness Probe & Water Level Probe

De-scale/Sanitize probes using the following procedure.

NOTE: Do not soak electrical connectors in de-scaler or sanitizer solution.

1. Mix a solution of Manitowoc ice machine de-scaler and water (2 ounces of de-scaler to 16 ounces of water) in a container.
2. Soak probes in container of de-scaler/water solution while disassembling and de-scaling/sanitizing water circuit components (soak probes for 10 minutes or longer).
3. De-scale/Sanitize all probe surfaces including all plastic parts (do not use abrasives). Verify all surfaces are clean. Thoroughly rinse probes with clean water.
4. Reinstall probe, then sanitize the ice machine and bin/dispenser interior surfaces.

Water Inlet Valve

The water inlet valve does not require removal for de-scaling/sanitizing. Refer to “Water System Checklist” on page 104, if you are troubleshooting water related problems.

1. When the ice machine is off, the water inlet valve must completely stop water flow into the machine. Watch for water flow.

When the ice machine is on, the water inlet valve must allow the proper water flow through it. Press the Power button to energize the ice machine. Watch for water flow into the ice machine. If the water flow is slow or only trickles into the ice machine, refer to water system checklist.

Water Dump Valve

The water dump valve does not require removal for de-scaling/sanitizing. To determine if removal is necessary:

1. Locate the water dump valve.
2. While the ice machine is in the freeze mode, check the drain to determine if the dump valve is leaking. If there is no or little water in the water trough (during the freeze cycle) the dump valve is leaking.
 - A. If the dump valve is leaking and debris is not visible and easily removed, the dump valve must be replaced.
 - B. If the dump valve is not leaking, do not remove it. Instead, follow the “Ice Machine De-scaling Procedure”.

Remedial De-scaling Procedure

This procedure will de-scale the components in the water flow path, and is used to de-scale the ice machine between the bi-yearly detailed de-scaling and sanitizing procedure.

Ice machine de-scaler is used to remove lime scale and mineral deposits. Ice machine sanitizer disinfects and removes algae and slime.

NOTE: Although not required and dependent on your installation, removing the ice machine top cover may allow easier access.

1. Ice must not be on the evaporator during the de-scaling/sanitizing cycle. Follow one of the methods below:
 - A. Press the power button at the end of a harvest cycle after ice falls from the evaporator(s).
 - B. Press the power button and allow the ice to melt.

 **Caution**

Never use anything to force ice from the evaporator. Damage may result.

2. Open the front panel to access the evaporator.
3. Press the Clean button and select “Make ice when complete”. Water will flow through the water dump valve and down the drain. Wait approximately 1 minute until the water trough refills and the display indicates Add Chemical. Add the proper amount of ice machine de-scaler to the water trough by pouring between the water curtain and evaporator, then confirm the chemical was added.

Model	Amount of De-scaler
IF0600C/IBF0620C/IBF0820C IF0900C/IBT1020C/IT1200C	5 ounces (150 ml)
IF1400C/IT1430C/IF1800C/ IT1830C/IF2100C/IT2130	9 ounces (265 ml)

4. Close and secure the front panel. The ice machine will automatically start ice making after the de-scale cycle is complete (approximately 24 minutes).

NOTE: Once the cycle has started it must complete before the ice machine can make ice again. Returning it to ice making mode will not cancel a clean cycle.

Removal from Service/Winterization

General

Special precautions must be taken if the ice machine is to be removed from service for an extended period of time or exposed to ambient temperatures of 32°F (0°C) or below.

Notice

If water is allowed to remain in the ice machine in freezing temperatures, severe damage to some components could result. Damage of this nature is not covered by the warranty.

1. Turn off the ice machine by pressing the Power Button.
2. Turn off the water supply.
3. Remove the water from the water trough.
4. Disconnect and drain the incoming ice-making water line at the rear of the ice machine.
5. Start the Ice making cycle by pressing the Power Button and wait one minute for the water inlet valve to open - or - Energize all relays in the touchscreen service menu.
6. Blow compressed air in both the incoming water and the drain openings in the rear of the ice machine until no more water comes out of the water inlet lines or the drain.
7. Disconnect the electric power at the circuit breaker or the electric service switch.
8. Make sure water is not trapped in any of the water lines, drain lines, distribution tubes, etc.

NOTE: www.manitowocice.com has an informational video on this and other topics.

Operation

Power Button

Lock/Unlock Screen

Cleaning Button



Touchscreen Features

The Indigo® NXT control panel offers a series of pressure-sensitive buttons and an interactive touchscreen.

Buttons

Power Button: Provides On/Off functions for the ice machine.

Lock/Unlock Button: Allows or prevents touchscreen navigation.







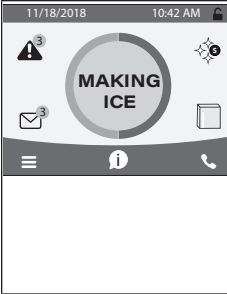
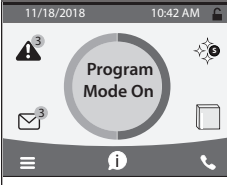
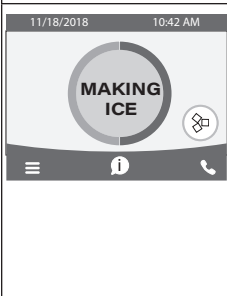
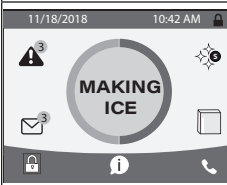

Cleaning Button: Initiates a Clean cycle. Refer to “Detailed De-scaling/Sanitizing Procedure” on page 39 for details.





NOTE: Touchscreen is to be activated with finger tips only.

Touchscreen

 A screenshot of a touchscreen interface. At the top, the date '11/18/2018' and time '10:42 AM' are displayed. The main area features a large circular gauge with 'MAKING ICE' text in the center. To the left of the gauge is a warning icon with a '3' notification bubble, and below it is an envelope icon with a '3' notification bubble. To the right of the gauge is a sun icon with a '3' notification bubble and a document icon. At the bottom, there is a dark navigation bar with a hamburger menu icon, an information icon, and a phone icon.	<p>Home screen allows viewing of ice machine status, alerts and messages. Navigation with the touchscreen provides access to menu items, machine information, settings and alert logs. Setup and Energy Saver settings can be adjusted along with access to service and troubleshooting information. The icons provide status indication and allow navigation by pressing the icon.</p>
 A screenshot of a touchscreen interface. At the top, the date '11/18/2018' and time '10:42 AM' are displayed. The main area features a large circular gauge with 'Program Mode On' text in the center. To the left of the gauge is a warning icon with a '3' notification bubble, and below it is an envelope icon with a '3' notification bubble. To the right of the gauge is a sun icon with a '3' notification bubble and a document icon. At the bottom, there is a dark navigation bar with a hamburger menu icon, an information icon, and a phone icon.	<p>Prior to Revision 9 software: The touchscreen will display Program Mode On, whenever the ice machine is off due to a bin level probe, weight program or time program.</p>
 A screenshot of a touchscreen interface. At the top, the date '11/18/2018' and time '10:42 AM' are displayed. The main area features a large circular gauge with 'MAKING ICE' text in the center. To the right of the gauge is a bypass icon (a square with a diagonal line). At the bottom, there is a dark navigation bar with a hamburger menu icon, an information icon, and a phone icon.	<p>Revision 9 software - The touchscreen will display a Making Ice button with a Green outer ring during ice making; A Machine Off button with an Orange outer ring whenever the ice machine has turned off on either Time, Weight or Night Off; An Ice Now Bypass Program button with a Light Blue/Dark Blue outer ring, that allows immediate ice production regardless of ice program settings.</p>
 A screenshot of a touchscreen interface. At the top, the date '11/18/2018' and time '10:42 AM' are displayed. The main area features a large circular gauge with 'MAKING ICE' text in the center. To the left of the gauge is a warning icon with a '3' notification bubble, and below it is an envelope icon with a '3' notification bubble. To the right of the gauge is a sun icon with a '3' notification bubble and a document icon. At the bottom, there is a dark navigation bar with a lock icon, an information icon, and a phone icon.	<p>The touchscreen will display a lock in place of the menu icon when the touchscreen has been locked.</p>

HOME SCREEN ICON DESCRIPTIONS

Icon	Description
<p data-bbox="158 203 329 233">Home Screen</p> 	<p data-bbox="355 203 951 348">The center portion of the screen which displays the current condition of the ice machine - Making ice, bin full, program mode or machine off.</p>
<p data-bbox="210 393 277 423">Alert</p> 	<p data-bbox="355 393 930 505">Alert icon with number of messages. Pressing this icon will display the alert log which will allow viewing and resetting of alerts.</p>
<p data-bbox="189 584 298 613">Message</p> 	<p data-bbox="355 584 956 729">Message icon with number of messages. Pressing this icon will display the routine maintenance reminder screen which will allow viewing and resetting of the reminder.</p>
<p data-bbox="205 774 272 803">Menu</p> 	<p data-bbox="355 774 894 885">Menu icon will take you to the main menu. Note: This icon changes to a lock if the touchscreen lock has been selected.</p>
<p data-bbox="168 970 324 999">Information</p> 	<p data-bbox="355 970 956 1081">Information icon provides model and serial number, installation date and other information specific to the ice machine.</p>
<p data-bbox="148 1162 339 1191">Service Locator</p> 	<p data-bbox="355 1162 935 1274">Provides contact information for your local service support - Default is the Manitowoc Ice website service locator.</p>
<p data-bbox="163 1377 324 1407">Lock/Unlock</p> 	<p data-bbox="355 1377 878 1489">Indicates if screen is locked or unlocked. The icon is only visible when the screen is locked.</p>
<p data-bbox="179 1573 308 1603">LuminIce®</p> 	<p data-bbox="355 1573 914 1758">Only visible when a LuminIce® II accessory is connected. Blue S - Normal operation Red S - Replace bulb Red/Blue alternating - Incorrect bulb installed</p>

Icon	Description
<p data-bbox="137 162 213 192">iAuCS</p> 	<p data-bbox="288 162 831 231">This icon appears when the iAuCS activates during a programmed cleaning cycle.</p>
<p data-bbox="106 354 246 384">Making Ice</p> 	<p data-bbox="288 354 888 462">This icon with a green ring appears after the ice machine has been programmed to run either by time, weight or night off.</p>
<p data-bbox="96 546 256 576">Machine Off</p> 	<p data-bbox="288 546 883 654">This icon with an orange ring appears after the ice machine has been turned off by either time, weight or night off program.</p>
<p data-bbox="127 738 225 768">Ice Now</p> 	<p data-bbox="288 738 878 846">This icon with a light blue/dark blue ring allows immediate ice production regardless of ice program settings.</p>
<p data-bbox="96 931 262 995">Green Power Button</p> 	<p data-bbox="288 931 871 1109">This icon appears if the machine shuts off on Long Freeze or Long Harvest. To restart the machine press the Green Power Button on the display or by recycling power. This can only be done three times in a 24 hour period.</p>

Setup Wizard

Screens will automatically advance after a selection is made or press the arrows to advance/go back one screen. All settings can be accessed and changed without the wizard by using menu screen navigation.





Setup	Description
Press Power Button	The power button (ON/OFF) is used to start/stop ice making.
Select Language	Default is English. Scroll to select a different language.
Start Wizard	Setup wizard will guide ice machine programming.
Date and Time Configuration	Select Month/Day/Year or Day/Month/Year. Select 12 hour or 24 hour time format.
Set Local Time	Use arrows to set local time.
Verify Date	Use arrows to set date for your location.
Accessory Detection	Detects if Ice Level Sensor, LuminIce® II or iAuCS are connected. Checkmark = yes - X = no
USB Setup	Only used when setup features have been transferred to a USB drive. Skip screen by selecting right arrow.
Units	Select standard or metric.
Brightness	Configure screen brightness during normal operation.
Ice Program	Program ice machine run times or press right arrow to skip this setup.
Cleaning Reminder	Set de-scale and sanitize reminder or press right arrow to skip.
iAuCS*	Set frequency of operation.
Air Filter	Set to ON for self-contained air-cooled models.
Water Usage	Factory default - or - Use less water for reverse osmosis systems (Refer to “Detailed De-scaling and Sanitizing” on page 39) - or - Use more water to improve clarity for unfiltered water.
Water Filter*	Select Yes or No, set reminder interval
LuminIce II*	12 month reminder is auto-set.
Wizard Complete	Press right arrow or home icon to return to home screen.

* - Indicates optional accessory, when detected





Menu Navigation Overview





SETTINGS MENU SCREEN NAVIGATION









Select SETTINGS Icon from the Home Screen to access Main Menu screen. The main menu screen contains four main headings, which allow access to subheadings under each main heading.

	Energy
	Ice Program
	Continuous Mode - Default, No Program
	Time Program - Select Daily On/Off times
	Weight Program - Select Daily Production Weight
Night Off Program - Select Night On/Off Times	
	Water Usage
	Use Factory Default
	Use Less Water With Reverse Osmosis
Use More Water To Improve Ice Clarity	
	Statistics
	Ice Production - Previous 7 Days
	Water Usage - Previous 7 Days
	Energy Usage - Previous 7 Days

NOTE: The performance statistics are calculated based on the performance of the ice machine at 90°F (32°C) ambient temperature and 70°F (21°C) water temperature. The actual statistics will vary dependent on your environmental conditions.

	Service
	<p>Data</p> <p>Real Time Data</p> <p>Time and Temperature</p> <p>Inputs</p> <p>Outputs</p> <p>Data History for 5 Previous Days Minimum and Maximum Freeze (Length, Time of day, Thermistor Temperatures) Minimum and Maximum Harvest (Length, Time of day, Thermistor Temperatures)</p> <p>Lifetime Data History Installation Date Control Board Replacement Date Control Board Manufacture Date Runtime Cycle Count Potable Water Clean Cycles</p>
	<p>Alert Log</p> <p>Lists/Clears Alerts</p>
	<p>Manual Harvest</p> <p>Off or On</p>
	<p>Control Board Replacement</p> <p>Manual Replacement Manually enter model number Manually enter serial number Manually enter condenser serial number (optional) Verification</p> <p>USB Replacement Import to ice machine Export to USB</p>

	Service
	Diagnostics
	Control board
	Enable All Relays
	Self Check
	Temperature Sensors
	Lists Sensor Temperatures
	Inputs
	Lists Control Board Input Information
	User Interface
	Screen Calibration Button Diagnostics Screen Diagnostics
Screen Calibration	
	Contact information
	Factory defaults to QR code and website address to Manitowoc Ice's Global Locator. Edit Contact Information Button.
	USB
	Upgrade Firmware
	Export Data
	iAuCS
	Manually initiate the iAuCS pump for pump/hose priming. NOTE: The clean button does not initiate the iAuCS pump.

	Settings
	Language
	Select Language
	Reminders
	Clean Reminder
	Set Month Interval
	Air Filter
	Set On/Off/Interval
	Water Filter
	Set Reminder
	Configure Date & Time
	Configure Date & Time
	Set Time
	Set Date
	Units
	Standard or Metric
	Brightness
	Adjust Touchscreen Brightness for Sleep Mode or Inactivity. NOTE: 100% brightness is activated by touching the screen when the lock feature is off.
	USB
	Import Settings To Ice Machine
	Export Settings To USB
	iAuCS
	When the iAuCS is detected, the icon will appear in the settings menu to set frequency of cleanings with iAuCS

	Reset Defaults
	Require Setup Wizard Optional Setup Wizard restart for training purposes or resale of equipment.
	Backup Current Settings
	Import To Ice Machine
	Export To USB
	Reset Factory Defaults

Operational Checks

GENERAL

Manitowoc ice machines are factory-operated and adjusted before shipment. Normally, new installations do not require any adjustment.

To ensure proper operation, always follow the Operational Checks:

- when starting the ice machine for the first time
- after a prolonged out of service period
- after cleaning, de-scaling and sanitizing

NOTE: Routine adjustments and maintenance procedures are not covered by the warranty.

Important

Refrigeration compressors must be operated for a minimum break in period of 24 hours before full ice production will be reached.

ICE THICKNESS CHECK

The ice thickness probe is factory-set to maintain the ice bridge thickness at 1/8 in. (3 mm).

NOTE: Make sure the water curtain/splash shields are in place when performing this check. It prevents water from splashing out of the water trough. Remove the curtain to make an adjustment, then replace immediately after the adjustment is made.

1. Inspect the bridge connecting the cubes. It should be 1/8 in. (3 mm) thick.
2. If adjustment is necessary, turn the ice thickness probe adjustment screw clockwise to increase bridge thickness or counterclockwise to decrease bridge thickness. Set a 9/32" gap between the ice thickness probe and evaporator as a starting point. Then adjust to achieve 1/8" ice thickness.
3. Make sure the ice thickness probe wire and the bracket do not restrict movement of the probe.

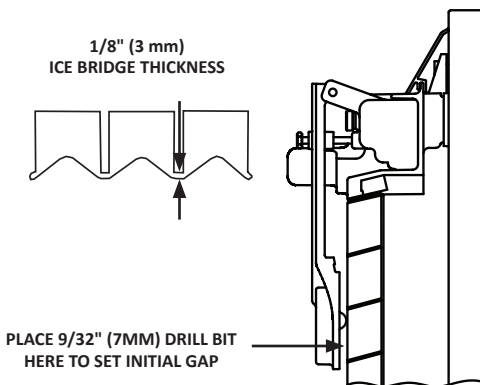

Ice Thickness Check

NOTE: Turning the adjustment 1/3 of a turn will change the ice thickness about 1/16" (1.5 mm). Make adjustment only when the ice machine is off to prevent initiating a harvest.

Control Board Timers

The control board has the following non-adjustable timers:

- The ice machine is locked into the freeze cycle for 6 minutes before a harvest cycle can be initiated. This can be overridden by initiating a manual harvest. Refer to “Manual Harvest” on page 65.
- The maximum freeze time is 35 minutes at which time the control board automatically initiates a harvest sequence.
- The maximum harvest time is 7 minutes, the control board will perform a Thaw Cycle and then return the ice machine to the freeze cycle.
- Maximum water fill time in the freeze cycle:
 - Single evaporator 6 minutes.
 - Dual evaporator 8 minutes

Sequence of Operation

QUIETQUBE® MODELS

NOTE: The power button must be depressed and the water curtain/ice dampers must be in place on the evaporator before the ice machine will start.

INITIAL START-UP OR START-UP AFTER AUTOMATIC SHUT-OFF

1. Water Purge

Before the compressor starts, the water pump and water dump solenoid energize to purge the ice machine of old water. This feature ensures that the ice making cycle starts with fresh water.

2. Refrigeration System Start-Up

Ice Machine Head Section:

The harvest valve(s), air pump(s) and liquid line solenoid valve energize to equalize high and low side refrigeration pressure. After 10 seconds the harvest valve(s) and air pump(s) de-energize.

CVD Condensing Unit:

WITH DELAY TIMER

The low pressure switch closes and sends voltage to the delay timer. The delay timer when closed sends voltage to the contactor coil, which energizes the compressor.

WITHOUT DELAY TIMER

The low pressure switch closes when the pressure rises above the set point of the low pressure switch.

FREEZE SEQUENCE

3. Prechill

The compressor lowers the temperature of the evaporator(s) before the water pump is energized. The water fill valve will energize and remain on until water completes the water level probe circuit.

4. Freeze

The water pump energizes and water flows over the evaporator. After water contacts the water level probe the water fill valve de-energizes. The control board will automatically cycle the water fill valve. The valve energizes once in the pre-chill and up to twice in the freeze cycle.

The freeze cycle continues until the six minute freeze lock expires and enough ice has formed to send a signal from the ice thickness probe to the control board.

Water Pump

The water pump(s) energizes and water flows over the evaporator. The water pump is energized throughout the freeze cycle.

Water Inlet Valve

The water inlet valve energized in prechill. After water contacts the low and high water probes the water fill valve de-energizes. Ice builds on the evaporator and the water level drops. When water loses contact with the high water probe, the water fill valve energizes until water contacts the high water probe again.

NOTE: After the second fill the water valve relay is locked out.

Maximum Fill Time = Prechill fill time + first fill + second fill.

SINGLE EVAPORATOR MAXIMUM FILL TIME

Initial startup or startup after automatic shutoff

Prechill (2 minutes) + first fill time (6 minutes) + second fill time (6 minutes) = 14.0 minutes.

Consecutive cycles

Prechill (30 sec.) + first fill time (6 minutes) + second fill time (6 minutes) = 12.5 minutes.

DUAL EVAPORATOR MAXIMUM FILL TIMES

Initial startup or startup after automatic shutoff

Prechill (2 minutes) + first fill time (8 minutes) + second fill time (8 minutes) = 18.0 minutes.

Consecutive cycles

Prechill (30 sec.) + first fill time (8 minutes) + second fill time (8 minutes) = 16.5 minutes.

HARVEST SEQUENCE

5. Water Purge

The air pump(s) and the harvest valve(s) open at the beginning of the water purge to divert refrigerant gas into the evaporator.

The water pump continues to run, and the water dump valve energizes to purge the water in the water trough.

CVD Condensing Unit:

When the refrigerant pressure is low enough to open the fan cycling pressure control the condenser fan motor stops.

6. Harvest

The air pump(s) remain energized and the harvest valve(s) remains open. The refrigerant gas warms the evaporator causing the cubes to begin melting and slide, as a sheet, off the evaporator and into the storage bin.

If the damper/curtain does not open within 3.5 minutes in the harvest cycle the following occurs:

- 3.5 minutes - The water inlet valve energizes until water touches the high water level probe.
- 4 minutes - The water pump energizes.
- 6.5 to 7 minutes - The water dump valve energizes.
- If bin switch does not open before 7 minutes the ice machine will start a Thaw Cycle.

Single evaporator models - The sliding sheet of cubes opens the water curtain/ice damper and bin switch.

The momentary opening and re-closing of the bin switch will terminate the harvest sequence and return to the freeze sequence (Step 3 - 4).

Dual evaporator models - The sliding sheet of cubes opens the ice damper and bin switch. The momentary opening and re-closing of the bin switch de-energizes the harvest valve for that evaporator. When the bin switches have opened and closed for both evaporators the ice machine will terminate the harvest sequence and return to the freeze sequence (Step 3 - 4).

AUTOMATIC SHUT-OFF

7. Automatic Shut-Off

Ice Machine Section: Shuts off when:

- The storage bin is full at the end of a harvest sequence.
- The sheet of cubes fails to clear the water curtain and holds it open.
- One or both ice dampers are held down.
- Bin level probe thermistor senses setpoint (when used).

After the water curtain or ice damper are held open for 30 seconds, the ice machine shuts off. The ice machine control board starts a 5 minute delay which must time out before the ice machine can automatically restart.

CVD Condensing Unit: The liquid line solenoid valve closes and the condensing unit pumps down. The LPCO opens, starts a five minute delay period and de-energizes the contactor coil, which de-energizes the compressor and condenser fan motor.

RESTART AFTER AUTOMATIC SHUT-OFF

The ice machine remains off until enough ice has been removed to allow the ice to fall clear of the water curtain or ice damper. As the water curtain or ice damper swings back to the operating position, the bin switch re-closes and the ice machine restarts (steps 1 - 2), provided the 5 minute control board delay period and 5 minute condensing unit delay periods have completed.

Single & Twin Evaporator QuietQube® Models Energized Parts Chart								
Ice Making Sequence of Operation	Water Pump	Harvest Valve(s)	Air Pumps	Water Inlet Valve	Water Dump Valve	Liquid Line Solenoid Valve	Contactors Refrigeration Compressor & Condenser Fan Motor*	Length of Time
Start-Up - Initial or After Auto Shut Off	On	Off	Off	Off	On	Off	Off	45 Seconds
1. Water Purge								
2. Refrigeration System Start-up								
Pressure Equalization	Off	On	On	Off	Off	Off	Off	5 Seconds
Compressor Start	Off	On	On	Off	Off	On	On	5 Seconds

**Single & Twin Evaporator QuietQube® Models
Energized Parts Chart**

Ice Making Sequence of Operation	Water Pump	Harvest Valve(s)	Air Pumps	Water Inlet Valve	Water Dump Valve	Liquid Line Solenoid Valve	Contactors Refrigeration Compressor & Condenser Fan Motor*	Length of Time
Freeze Sequence	Off	Off	Off	May cycle On/Off	Off	On	On	Initial Start-Up is 120 Seconds thereafter 30 Seconds thereafter
3. Pre chill								
4. Freeze	On	Off	Off	Cycles Off then On/Off, two more times	Off	On	On	Until Ice contact with ice thickness probe
Harvest Sequence	On	On	On	Off	On	On	On	Factory-set at 45 Seconds
5. Water Purge								

Single & Twin Evaporator QuietQube® Models Energized Parts Chart								
Ice Making Sequence of Operation	Water Pump	Harvest Valve(s)	Air Pumps	Water Inlet Valve	Water Dump Valve	Liquid Line Solenoid Valve	Contactors Refrigeration Compressor & Condenser Fan Motor*	Length of Time
6. Harvest	Off	On	On	Off	Off	On	On	Bin switch activation
Water Assist Starts 3.5 minutes in harvest cycle	Off **	On	On	On	Off**	On	On	Until curtain switch activation
7. Automatic Shut-Off	Off	Off	Off	Off	Off	Off	Off	Until 5 min. delay expires & all bin switches re-close

* The condenser fan motor is controlled by a fan cycle control and may cycle on/off.

* The contactor is controlled by a low pressure control and may cycle on/off whenever power is supplied to the condensing unit.

** Water Pump On after 4 minutes - Dump Valve On after 6.5 minutes.

THIS PAGE INTENTIONALLY LEFT BLANK

Troubleshooting

Troubleshooting

Check the touchscreen for alerts - An alert icon with the number of messages will be displayed if alerts are present. Pressing the alert icon will display the alert log which will allow viewing and resetting of alerts. Refer to the alert log on the following pages for a description of the alert.

NOTE: There are two sequences that allow the ice machine to continue ice making during alerts:

Thaw Cycle

When the damper/curtain does not open during the 7 minute harvest cycle (E02 fault) a thaw cycle starts. See "Thaw Cycle" on page 88

Safe Operation Mode

Allows the ice machine to operate up to 72 hours if the ice thickness probe (E19 fault) and/or water level probe sensors fail (E20 fault). See "Safe Operation Mode" on page 89

ALERT LOG

Refer to Alert Log Detail For Code descriptions.

Displayed Text	Code	Description
Long Freeze	E01	Long Freeze Cycle
Long Harvest	E02	Long Harvest Cycle
Power Loss	E03	Input Power Loss
Hi Cnd Temp or Wtr Cnd Fault	E04	High Condenser Temperature
HPC Fault	E05	High Pressure Control Opened
	E06	Spare
Starving TXV	E07	Starving TXV Single Evaporator or Low On Charge
TXV Fault	E08	TXV Fault Single or Dual Circuit Evaporators
Flood Evap1	E09	Flooding Evaporator Fault Single Evaporator, Single Circuit
Flood Evap2	E10	Flooding Evaporator Fault Dual TXV, Dual Circuit
Refrig Fault	E11	Refrigeration Fault
Curtain Fault	E12	Curtain Switch Fault - Open more than 24 hours
	E13	Spare
	E14	Spare
Low liq temp	E15	Fan Cycle Control Fault - Low Liquid Line Temperature
Rmt Cnd Fault	E16	Remote Condensing Unit Fault (CVD Only)
	E17	Spare
	E18	Spare
ITP Fault	E19	Ice Thickness Probe Fault
WTR Fault	E20	Water System Fault
T1 Fault	E21	T1 Temperature Sensor Issue
T2 Fault	E22	T2 Temperature Sensor Issue
T3 Fault	E23	T3 Temperature Sensor Issue
T4 Fault	E24	T4 Temperature Sensor Issue
T5 Bin Probe	E25	Bin Level Probe Sensor Fault (IB Only)
T6 Fault	E26	T6 or T7 Temperature Sensor Issue
T7 Fault	E27	T6 or T7 Temperature Sensor Issue
iAUCS	E28	iAuCS Not Detected Alert Log Only
USB Comm	E29	USB Communication Fault
USB DNLD	E30	USB Download Fault
Safe Mode	E31	Safe Mode
RS485 COMM	E32	RS485 Communication Fault
Keyboard	E33	Touchscreen Fault
Display	E34	Display Fault

Displayed Text	Code	Description
Checksum	E36	Check Sum Error
WatchDog	E37	Watch Dog Alert
UI Comm	E38	UI Comm Alert

ALERT LOG DETAIL

E01 Long Freeze

3 consecutive 35 minute freeze cycles = Ice machine is off.

E02 Long Harvest

3 consecutive 7minute harvest cycles = Ice machine is off.

E03 Power Loss

When power is interrupted to the ice machine the control board will log the alert in the ELOG and stamp the loss of power on power-up.

E04 High Condenser Temperature

Liquid Line Temperature too High for Self-contained Air Cooled Ice machine = Air Cooled Condenser Fault

Or

Liquid Line Temperature too High for Self-contained Water Cooled ice machine = Water Cooled Condenser Fault

E05 High Pressure Control Opened

The high pressure cutout switch (HPCO) opened.

E06 Spare

E07 Starving TXV Single Evaporator or Low On Charge

The difference of the average evaporator inlet (T3) and outlet (T4) is greater than 12°F in the last 1 minute of the freeze cycle.

E08 TXV Fault Single or Dual Circuit Evaporators

The difference of the average evaporator inlet (T3) and outlet (T4) is greater than 12°F in the last 1 minute of the freeze cycle.

E09 Flooding Evaporator Fault Single Evaporator, Single Circuit

Average compressor discharge line temperature during the first 6 minutes of the freeze cycle (T2) compared to the average of the Prechill (T1) +50°F is less than 1.05°F.

E10 Flooding Evaporator Fault Dual TXV, Dual Circuit

Average compressor discharge line temperature during the first 6 minutes of the freeze cycle (T2) compared to the average of the Prechill (T1) +50°F is less than 1.05°F.

E11 Refrigeration Fault

The compressor discharge temperature did not increase by at least 10°F, and the evaporator temperature did not decrease by at least 10°F - Measured from Refrigeration Start up or Prechill until 2 minutes into the Freeze cycle.

E12 Curtain Switch Fault Open more than 24 hours

The ice machine is set to ice making and remains in bin full condition for more than 24 hours. The curtain switch is open or curtain is off.

E13 Spare

E14 Spare

E15 Fan Cycle Control Fault - Low Liquid Line Temperature

The liquid line temperature dropped below 60°F for more than one continuous minute during the freeze cycle.

E16 Remote Condensing Unit Fault (CVD Only)

The liquid line temperature dropped below 40°F, or exceeded 140°F for more than 1 continuous minute during the freeze cycle.

E17 Spare

E18 Spare

E19 Ice Thickness Probe Fault

The monitored Frequencies is out of the appropriate range (Probe unplugged or problem with microphone).

E20 Water System Fault

Any of the following:

1. Sensing high water probe and not low water probe.
2. Evaporator outlet temperature is less than -10°F 6.5 to 7.5 minutes in freeze cycle.
3. Low water probe is satisfied at the end of harvest.
4. Low or high water probe is satisfied at end of freeze cycle.

E21 T1 Temperature Sensor Issue

During Pre-chill the thermistor had an average value reading outside the valid range.

E22 T2 Temperature Sensor Issue

During Pre-chill the thermistor had an average value reading outside the valid range.

E23 T3 Temperature Sensor Issue

During Pre-chill the thermistor had an average value reading outside the valid range.

E24 T4 Temperature Sensor Issue

During Pre-chill the thermistor had an average value reading outside the valid range.

E25 Bin Level Probe Low Sensor Fault

The thermistor had an average value reading outside of the valid range for 10 continuous minutes.

E26 T6 or T7 Temperature Issue

The thermistor had an average value reading outside of the valid range.

E27 T6 or T7 Temperature Issue

The thermistor had an average value reading outside of the valid range.

E28 AuCS

When the AUCS clean option is selected from the menu, the control checks for the presence of the AUCS board. When the AUCS is not connected it will signal an alert which will clear as soon as the hardware is detected.

E29 USB Communication Fault

USB Communication error; No USB drive in port or defective USB drive.

E30 USB Download Fault

USB Download error related to USB drive or a defective USB drive.

E31 Safe Mode

Safe mode allows the ice machine to operate for a period of time in the event of a Water level or ice thickness probe failure. The controller allows the machine to operate based on model data and historical cycle information.

E32 RS485 Communication Fault

The device plugged into the RS485 port is not communicating between the control board and gateway.

E33 Touchscreen Fault

The Touchscreen is not plugged into the control board or is faulty.

E34 Display Fault

The touchscreen is not plugged into the control board or is faulty.

E36 Check Sum Error

Alert Log Only: Activates on power loss.

E37 Watch Dog Alert

Alert Log Only: Micro Process time out, possible electrical noise.

E38 UI Comm Alert

Alert Log Only: User interface communication error: loose communication cable, power interruption.

THAW CYCLE

When the damper/curtain does not open during the 7 minute harvest cycle the following ice thaw cycle occurs:

- 7 minutes - The compressor, harvest solenoid valve and dump valve de-energize.
The water pump remains energized and the water inlet valve energizes until water touches the high water level probe.
- Water is circulated, dumped and refilled to the high water level probe 18 times (approximately 1 hour).
Model 1200 or smaller:
Circulate 165 seconds, dump 45 seconds

Model 1400 and larger:
Circulate 240 seconds, dump 120 seconds
- At the end of the thaw cycle (approximately 1 - 1.75 hours) the ice machine will start another freeze cycle.

Curtain Operation In Water Assist Harvest

- Open & close damper = Continue Thaw Cycle
- Open damper 30 seconds = Full Bin Shutoff

Use the keypad and turn the ice machine off and then on to terminate the cycle. Disconnecting and reconnecting power to end the cycle will result in the ice machine restarting in a harvest cycle.

SAFE OPERATION MODE

Allows the ice machine to operate up to 72 hours if the ice thickness probe (E19 fault) and/or water level probe sensors fail (E20 fault).

- When the control board starts the safe mode, an alert is flashed on the display to notify the end-user they have a production problem.
- The control board automatically initiates and monitors the safe mode. The control will automatically exit the safe mode if a normal signal is received from the input.
- After 72 consecutive hours the control board will enter a standby mode and turn off.

NOTE: When the ice machine is first powered up or there is a power loss and restarted, a water fill time array will be used in calculating the average of the five cycles.

E01 LONG FREEZE CYCLE

If the freeze time reaches 35 minutes, the control board automatically initiates a harvest cycle. If 3 consecutive 35-minute freeze cycles occur, the ice machine stops.

E02 LONG HARVEST CYCLE

If the harvest time reaches 7 minutes, the control board will start a thaw cycle and automatically return the ice machine to the freeze cycle. After 3 consecutive long harvest cycles the ice machine stops.

ANALYZING WHY A SERVICE FAULT (E01 & E02) STOPPED THE ICE MACHINE

Some service Faults are designed to stop the ice machine prior to major component failures, most often a minor problem or something external to the ice machine. This may be difficult to diagnose, as many external problems occur intermittently.

Example: An ice machine stops intermittently on E01 Long Freeze (long freeze time). The problem could be a low ambient temperature at night, a water pressure drop, the water is turned off one night a week, etc.

Refrigeration and electrical component failures will cause a Service Fault. Eliminate all electrical components and external causes first. If it appears that the refrigeration system is causing the problem, use Manitowoc's procedures, charts, checklists, and other references to determine the cause.

The following checklists are designed to assist the service technician in analysis. However, because there are many possible external problems, do not limit your diagnosis to only the items listed.

E01 LONG FREEZE

Freeze time exceeds 35 minutes for 3 consecutive freeze cycles.

Possible Cause Checklist

Improper Installation

- Refer to “Installation/Visual Inspection Checklist” on page 103

Water System

- Dirty/Defective water level probe
- Low water pressure (20 psig min.)
- High water pressure (80 psig max.)
- High water temperature (90°F/32.2°C max.)
- Clogged water distribution tube
- Dirty/defective water fill valve
- Dirty/defective water dump valve
- Defective water pump
- Loss of water from sump area

Electrical System

- Low incoming voltage
- Ice thickness probe out of adjustment
- Harvest cycle not initiated electrically
- Contactor not energizing
- Compressor electrically non-operational
- Defective fan cycling control
- Defective fan motor

Miscellaneous

- Non-Manitowoc components
- Improper refrigerant charge
- Defective head pressure control
- Defective harvest valve
- Defective compressor
- TXV starving or flooding (check bulb mounting)
- Non-condensable in refrigeration system
- Plugged or restricted high side refrigerant lines or component
- Restricted air flow/dirty condenser fins
- High inlet air temperature
- Condenser discharge air recirculation

E02 LONG HARVEST

Harvest time exceeds 7 minutes for 3 consecutive harvest cycles.

Possible Cause Checklist

Improper Installation

- “Installation/Visual Inspection Checklist” on page 103

Water System

- Water area (evaporator) dirty
- Dirty/defective water dump valve
- Vent tube not installed on water outlet drain
- Water freezing behind evaporator
- Plastic extrusions and gaskets not securely mounted to the evaporator
- Clogged water distribution tube

Electrical System

- Ice thickness probe out of adjustment
- Bin switch closed/defective
- Premature harvest

Refrigeration System

- Non-Manitowoc components
- Improper refrigerant charge
- Defective head pressure control valve
- Defective harvest valve
- TXV flooding (check bulb mounting)
- Defective fan cycling control

Troubleshooting By Symptom

The troubleshooting procedures follow flow charts. There are four symptoms, the symptom that you are experiencing will determine which flow chart to use. The flow chart asks yes and no questions to determine the problem. The flow chart will direct you to a procedure to correct the problem. QuietQube® remote condensing units use separate charts.

SYMPTOM #1 ICE MACHINE STOPS RUNNING

Ice machine is in Ice Making cycle

or

Has a History of Shutting Down

- Refer to Ice Machine Stops Running Flow Chart

SYMPTOM #2 ICE MACHINE HAS A LONG FREEZE CYCLE

Ice Formation is Thick

or

Thin Ice Fill on inlet or outlet of Evaporator

or

Low Production

E01 Long Freeze (possible)

- Refer to Low Production, Long Freeze Cycle

SYMPTOM #3 WILL NOT HARVEST, CUBES NORMAL

Ice Machine Will Not Harvest - Freeze Cycle is Normal and Ice Cubes are Not Melted After Harvest

E02 Long Harvest (possible)

- Refer to Harvest Problems

SYMPTOM #4 WILL NOT HARVEST CUBES MELTED

Ice Machine Will Not Harvest - Freeze Cycle is Normal and Ice Cubes are Melted After Harvest

- Refer to Freeze Cycle Normal, Cubes Are Melted

RESET TO FACTORY DEFAULTS

Before starting troubleshooting procedures, reset the control board to factory defaults to prevent mis-diagnosis. Before resetting to factory defaults do one of the following:

- A. Copy settings to a usb device and flash settings into the control board when diagnostics are complete.
- B. Write down any customer settings so they can be re-entered when diagnostics are complete.

SYMPTOM #1 ICE MACHINE WILL NOT RUN

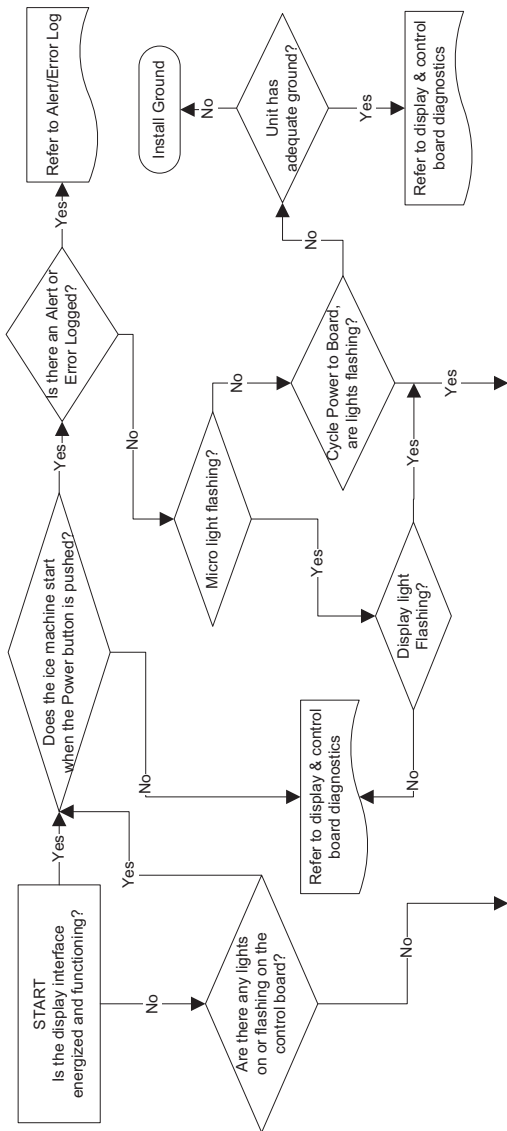

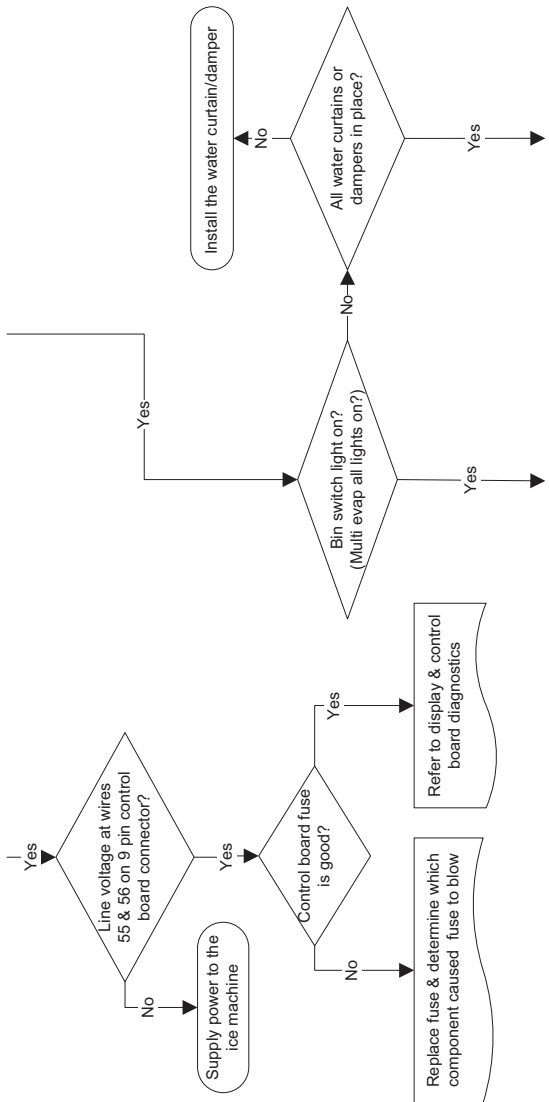

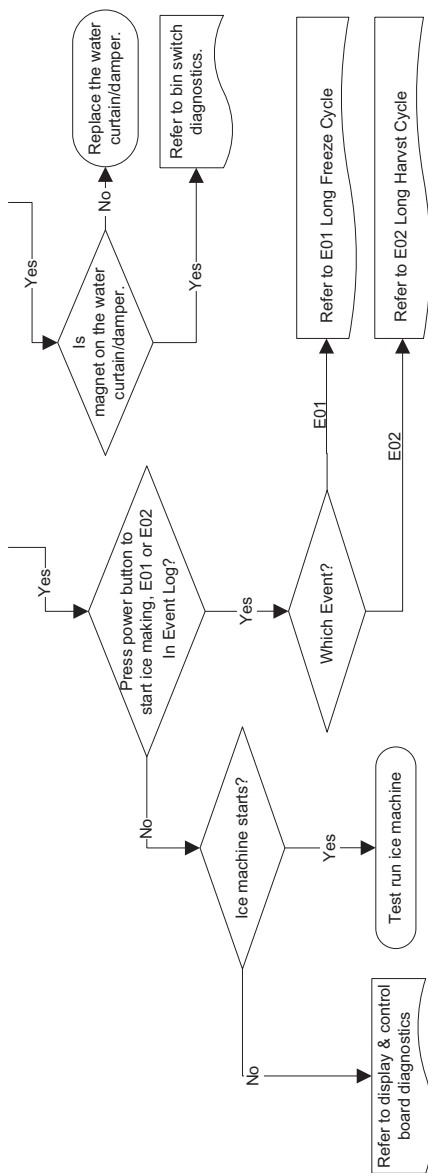

DIAGNOSING A CONDENSING UNIT THAT WILL NOT RUN

WITH DELAY TIMER

If the ice machine water pump is not energized, refer to “Diagnosing an Ice Machine that Will Not Run.”

1. Verify primary voltage is supplied to the ice machine condensing unit and the fuse/circuit breaker is closed.
2. Verify the high-pressure control is closed.
3. Verify the low-pressure control is closed.
4. Verify voltage is present at terminals 1 & 2 on the compressor delay timer.
5. Verify the delay timer period has expired and test for line voltage at compressor time delay relay terminals 1 & 3.
6. Verify line voltage is present at the contactor coil.
7. Verify the contactor contacts are closed and line voltage is present across all lines.
8. Refer to compressor diagnostics.

WITHOUT DELAY TIMER

If the ice machine water pump is not energized, refer to “Diagnosing an Ice Machine that Will Not Run.”

1. Verify primary voltage is supplied to the ice machine condensing unit and the fuse/circuit breaker is closed.
2. Verify the high-pressure control is closed.
3. Verify the low-pressure control is closed.
4. Verify line voltage is present at the contactor coil.
5. Verify the contactor contacts are closed and line voltage is present across all lines.
6. Refer to compressor diagnostics.

SYMPTOM #2 LOW PRODUCTION, LONG FREEZE CYCLE

Ice Machine has a Long Freeze Cycle

Ice Formation is Thick or Thin ice fill at Inlet or Outlet of Evaporator or Low Production

Information must be verified to eliminate non-refrigeration problems which can cause good refrigeration components to appear defective.

Before starting, see “Before Beginning Service” on page 100 for a few questions to ask when talking to the ice machine owner.

Before Beginning Service

Ice machines may experience operational problems only during certain times of the day or night. A machine may function properly while it is being serviced, but malfunctions later. Information provided by the user can help the technician start in the right direction, and may be a determining factor in the final diagnosis.

Ask these questions before beginning service:

- When does the ice machine malfunction? (night, day, all the time, only during the Freeze cycle, etc.)
- When do you notice low ice production? (one day a week, every day, on weekends, etc.)
- Can you describe exactly what the ice machine seems to be doing?
- Has anyone been working on the ice machine?
- During “store shutdown,” is the circuit breaker, water supply or air temperature altered?
- Is there any reason why incoming water pressure might rise or drop substantially?

Ice Production Check

The amount of ice a machine produces directly relates to the operating water and air temperatures. This means a condensing unit with a 70°F (21°C) outdoor ambient temperature and 50°F (10°C) water produces more ice than the same model condensing unit with a 90°F (32°C) outdoor ambient temperature and 70°F (21°C) water.

- Determine the ice machine operating conditions:
 - Air temp entering condenser: ____°
 - Air temp around ice machine: ____°
 - Water temp entering sump trough: ____°
- Refer to the appropriate 24-Hour Ice Production Chart (starting on page 181). Use the operating conditions determined in step 1 to find published 24-Hour Ice Production: _____
 - Times are in minutes.
Example: 1 min. 15 sec. converts to 1.25 min.
(15 seconds ÷ 60 seconds = .25 minutes)
 - Weights are in pounds.
Example: 2 lb. 6 oz. converts to 2.375 lb.
(6 oz. ÷ 16 oz. = .375 lb.)
- Perform an ice production check using the formula below.

1.	_____	+	_____	=	_____
	Freeze Time		Harvest Time		Total Cycle Time
2.	_____	÷	_____	=	_____
	1440 Minutes in 24 Hrs.		Total Cycle Time		Cycles per Day
3.	_____	×	_____	=	_____
	Weight of One Harvest		Cycles per Day		Actual 24-Hour Production

Weighing the ice is the only 100% accurate check. However, if the ice pattern is normal and the 1/8 in. thickness is maintained, the ice slab weights listed with the 24-Hour Ice Production Charts may be used.

4. Compare the results of step 3 with step 2. Ice production checks that are within 10% of the chart are considered normal. If they match closely, determine if:
 - Another ice machine is required.
 - More storage capacity is required.
 - Relocating the existing equipment to lower the load conditions is required.

Contact the local Manitowoc Distributor for information on available options and accessories.

Installation/Visual Inspection Checklist

Inadequate Clearances

- Check all clearances on sides, back and top.
See “Clearance Requirements” on page 30

Ice machine is not level

- Level the ice machine

Condenser is dirty

- Clean the condenser

Water filtration is plugged (if used)

- Install a new water filter

Water drains are not run separately and/or are not vented

- Run and vent drains according to the Installation Manual
- Floor drain must have an air gap
- Install condensation drain in the ice machine base

Line set is improperly installed

- Reinstall according to the Installation, Operation and Maintenance Manual

Lineset is the incorrect size

- Refer to Installation, Operation and Maintenance Manual
See “Water Supply and Drains” on page 33

Water System Checklist

A water-related problem often causes the same symptoms as a refrigeration system component malfunction. Water system problems must be identified and eliminated prior to replacing refrigeration components.

Water area (evaporator) is dirty

- Clean as needed

Water inlet pressure not between 20 and 80 psig (1-5 Bar, 138-552 kPa).

- Install water regulator or increase water pressure

Incoming water temperature is not between 35°F (2°C) and 90°F (32°C)

- If too hot, check the hot water line check valves in other store equipment

Water filtration is plugged (if used)

- Install a new water filter

Water dump valve leaking during the Freeze cycle

- Clean or replace dump valve as needed

Vent tube is not installed on water outlet drain

- See Installation Instructions

Hoses, fittings, etc., are leaking water

- Repair or replace as needed

Water fill valve is stuck open or closed

- Clean or replace as needed

Water is leaking out of the sump trough area

- Stop the water loss

Uneven water flow across the evaporator

- Clean the ice machine

Plastic extrusions and gaskets are not secured to the evaporator

- Remount/replace as needed

Ice Formation Pattern

Evaporator ice formation pattern analysis is helpful in ice machine diagnostics.

Analyzing the ice formation pattern alone cannot diagnose an ice machine malfunction. However, when this analysis is used along with Manitowoc's Freeze Cycle Refrigeration System Operational Analysis Tables, it can help diagnose an ice machine malfunction.

Any number of problems can cause improper ice formation.

Important

Keep the water curtain, splash shields and ice dampers in place while checking the ice formation pattern to ensure no water is lost.

1. Normal Ice Formation

Ice forms across the entire evaporator surface.

At the beginning of the Freeze cycle, it may appear that more ice is forming on the inlet of the evaporator than on the outlet. At the end of the Freeze cycle, ice formation at the outlet will be close to, or just a bit thinner than, ice formation at the inlet. The dimples in the cubes at the outlet of the evaporator may be more pronounced than those on the inlet. This is normal.

It is normal for ice thickness to vary up to 1/16" across the surface of the evaporator. The ice bridge thickness at the ice thickness control probe should be at least 1/8".

The ice thickness probe must be set to maintain the ice bridge thickness at approximately 1/8 in. If ice forms uniformly across the evaporator surface, but does not reach 1/8 inch in the proper amount of time, this is still considered a normal ice fill pattern.

2. Extremely Thin at Evaporator Outlet

There is no ice, or a considerable lack of ice formation, at the outlet of the evaporator.

Examples: No ice at all on the outlet half of the evaporator, but ice forms on the inlet half of the evaporator. Or, the ice at the outlet of the evaporator reaches 1/8 in. to initiate a harvest, but the inlet of the evaporator already has 1/2 in. to 1 in. of ice formation.

3. Extremely Thin at Evaporator Inlet

There is no ice, or a considerable lack of ice formation at the inlet of the evaporator. Examples: The ice at the outlet of the evaporator reaches 1/8 in. to initiate a harvest, but there is no ice formation at all on the inlet of the evaporator.

4. No Ice Formation

The ice machine operates for an extended period, but there is no ice formation at all on the evaporator.

Evaporator Tubing Routing

Routing of the tubing on the back of the evaporator determines the ice fill pattern failure mode. The evaporator outlet tubing does not exit directly at the top of the evaporator, but exits several inches below the top of the evaporator. Extremely Thin at the Evaporator Outlet will first be visible several inches below the top of the evaporator. Extremely Thin at Evaporator Inlet will first be visible at the bottom of the evaporator.

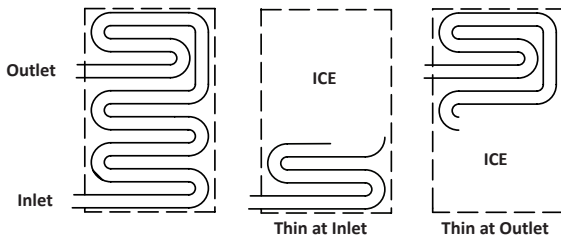

One Evaporator, Two TXV Models

Tubing routing for one evaporator with two TXV's is different. The evaporator has two inlets and outlets. Fill pattern varies depending on which circuit is affected.

Extremely Thin at the Evaporator Outlet will first be visible either 1/4 or 3/4 of the way down the evaporator.

Extremely Thin at the Evaporator Inlet will show at the bottom of the evaporator or 1/2 of the way down depending on the circuit affected.

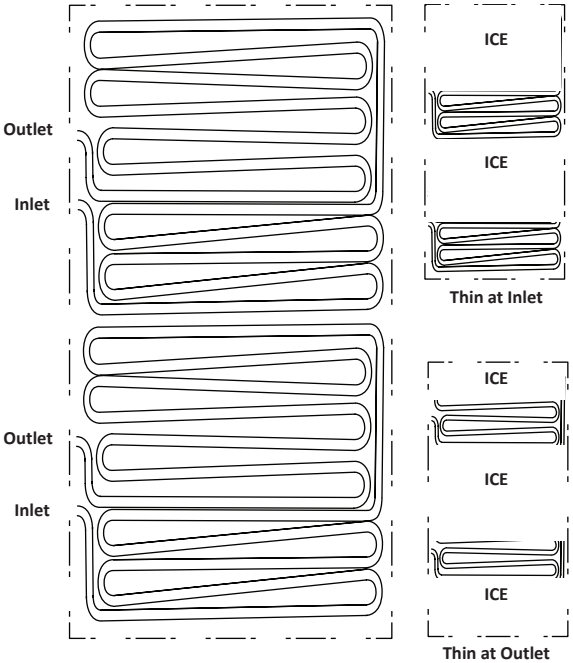

Analyzing Discharge Pressure in the Freeze Cycle

1. Determine the ice machine operating conditions:
Air temp. entering condenser _____°
Air temp. around ice machine _____°
Water temp. entering sump trough _____°
2. Refer to “Cycle Times/24-Hour Ice Production/
Refrigerant Pressure Charts” on page 181 for ice
machine being checked.
3. Use the operating conditions determined in step 1 to
find the published normal discharge pressures.
Freeze Cycle _____
Harvest Cycle _____
4. Perform an actual discharge pressure check.

Freeze Cycle
psig (kPa)

1 Minute into

the Freeze Cycle

Middle of Freeze Cycle

End of Freeze Cycle

5. Compare the actual discharge pressure (step 3) with
the published discharge pressure (step 2).

The discharge pressure is normal when the actual
pressure falls within the published pressure range
for the ice machine’s operating conditions. It is
normal for the discharge pressure to be higher at the
beginning of the Freeze cycle (when load is greatest),
then drop throughout the Freeze cycle.

FREEZE CYCLE DISCHARGE PRESSURE HIGH CHECKLIST

Improper Installation

- Refer to “Installation/Visual Inspection Checklist” on page 103

Air Condenser

- Dirty condenser filter
- Dirty condenser fins
- High inlet air temperature
- Condenser discharge air recirculation
- Defective “Fan Cycle Control” on page 156)
- Defective fan motor
- Defective head pressure control valve (Remote)

Other

- Overcharged
- Non-condensable (air) in system
- Wrong type of refrigerant
- Non-Manitowoc components in system
- High side refrigerant lines/component restricted

FREEZE CYCLE DISCHARGE PRESSURE LOW CHECKLIST

Improper Installation

- Refer to “Installation/Visual Inspection Checklist” on page 103

Condenser

- Defective head pressure control valve, won't bypass page 161
- Defective fan cycle control, stuck closed (page 156)

Other

- Undercharged
- Wrong type of refrigerant
- Non-Manitowoc components in system
- Liquid line/component restricted

Analyzing Suction Pressure

The suction pressure gradually drops throughout the freeze cycle. The actual suction pressure (and drop rate) changes as the air and water temperature entering the ice machine changes. These variables also determine the freeze cycle times.

To analyze and identify the proper suction pressure drop throughout the freeze cycle, compare the published suction pressure to the published freeze cycle time.

NOTE: Analyze discharge pressure before analyzing suction pressure. High or low discharge pressure may be causing high or low suction pressure.

1. Determine the ice machine operating conditions:

Air temp. entering condenser _____°

Air temp. around ice machine _____°

Water temp. entering sump trough _____°

2. Refer to Operating Pressure table (starting on page 177) for ice machine being checked.
3. Use the operating conditions determined in step 1 to find the published normal discharge pressures.

Freeze Cycle _____

Harvest Cycle _____

4. Perform an actual suction pressure check.

	Freeze Cycle psig (kPa)
1 Minute into the Freeze Cycle	_____
Middle of Freeze Cycle	_____
End of Freeze Cycle	_____

5. Compare the actual suction pressure (step 3) with the published suction pressure (step 2).

NOTE: The suction pressure is normal when the actual pressure falls within the published pressure range for the ice machine's operating conditions. It is normal for the suction pressure to be higher at the beginning of the Freeze cycle (when load is greatest), then drop throughout the Freeze cycle.

SUCTION PRESSURE HIGH CHECKLIST

Improper Installation

- Refer to “Installation/Visual Inspection Checklist” on page 103

Discharge Pressure

- Discharge pressure is too high and is affecting suction pressure – refer to “Analyzing Discharge Pressure in the Freeze Cycle” on page 108

Improper Refrigerant Charge

- Overcharged
- Wrong type of refrigerant
- Non condensible in system

Components

- Harvest valve leaking
- TXV flooding
- Defective compressor

Other

- Non-Manitowoc components in system

SUCTION PRESSURE LOW CHECKLIST

Improper Installation

- Refer to "Installation/Visual Inspection Checklist" on page 103

Discharge Pressure

- Discharge pressure is too low and is affecting low side – refer to "Analyzing Discharge Pressure in the Freeze Cycle" on page 108

Improper Refrigerant Charge

- Undercharged
- Wrong type of refrigerant

Other

- Non-Manitowoc components in system
- Improper water supply over evaporator – refer to "Water System Checklist" on page 104
- Restricted/plugged liquid line drier
- Restricted/plugged tubing in suction side of refrigeration system
- TXV starving
- Liquid line solenoid valve closed

Harvest Valve Analysis

Symptoms of a harvest valve remaining partially open during the freeze cycle can be similar to symptoms of either an expansion valve or compressor problem. Use the following procedures to determine if a harvest valve is remaining partially open during the freeze cycle.

QUIETQUBE® HARVEST VALVE ANALYSIS

The valve can fail in two positions:

- Valve will not open in the Harvest cycle.
- Valve remains open during the Freeze cycle.

Valve will not open in the Harvest cycle

Although the circuit board has initiated a Harvest cycle, suction and discharge pressures remain unchanged from the Freeze cycle. The ice machine will remain in the Harvest cycle for 7 minutes, then initiate a thaw cycle.

Valve remains open in the Freeze cycle

Symptoms of a harvest valve remaining partially open during the Freeze cycle can be similar to symptoms of an expansion valve or compressor problem. Symptoms are dependent on the amount of leakage in the Freeze cycle.

A small amount of leakage will cause increased freeze times and an ice fill pattern that is normal.

As the amount of leakage increases, the length of the Freeze cycle increases and the amount of ice on the bottom of the evaporator decreases.

A small amount of leakage will cause an audible indication as the vapor passes through the valve. As the size of the leak increases, the audible indication becomes more apparent.

Analyzing Freeze Cycle Suction Line Temperature

Suction line temperature alone cannot diagnose an ice machine. However, comparing this temperature during the freeze cycle can help diagnose an ice machine malfunction.

The actual temperature of the suction line varies by model, and will change throughout the freeze cycle. This makes documenting the “normal” suction line temperature difficult. The key to the diagnosis is observing the compressor suction line temperature during the last three minutes of the freeze cycle.

1. Navigate to Service/Diagnostics/Temperature Sensors and view T3 & T4 Thermistors.
2. Monitor the suction line temperature during the last three minutes of the freeze cycle and record the low event.
3. Verify refrigerant amount is correct by weight when recovering refrigerant and replacing a TXV. Grossly overcharged QuietQube® ice machine in ambient temperatures below 70°F will have a suction line temperature below 10°F and liquid line subcooling will be greater than 25°F.

SYMPTOM #3 HARVEST PROBLEMS

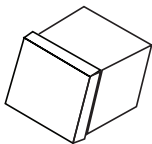

Normal Ice Cube

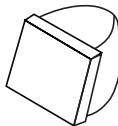

Melted Out Ice Cube

Definition of a harvest problem; At the end of a 7 minute harvest cycle the slab(s) of ice is still contacting the evaporator. The slab of ice may or may not be removable by hand. Harvest problems can be split into two categorizes.

- Melted sheet of cubes at the end of the harvest cycle. Ice can be removed rather easily by hand. The back of the cubes are misshapen and melted. This indicates something is on the evaporator preventing the ice slab from releasing. Follow the appropriate troubleshooting flow chart to determine the cause of the problem. A manual cleaning procedure must always be performed when this problem is encountered.
- Normal sheet of cubes at the end of the harvest cycle. Ice is difficult to remove from the evaporator by hand. Once removed the back of the cubes are square and show no signs of melting. This indicates a refrigeration problem. The source of the problem could be in the freeze or harvest cycle. Use the appropriate troubleshooting flow chart to determine the cause of the problem.

Diagnosing Harvest Issues

Follow these steps in order and refer to specific procedures referenced to troubleshoot and diagnose problems.

1. Record the model and serial number of the ice machine and condenser and verify the head section and condensing unit match.
2. Verify the ice formation is normal see page 105 and the bridge thickness is 1/8" at the beginning of the harvest cycle see "Ice Thickness Check" on page 70.
3. Verify power is present at the harvest valve(s) throughout the entire harvest cycle.
4. Determine if it is a "melt out" see page 116. Melted cubes indicate this is not a refrigeration problem. Inspect the evaporator for defects; grid separation, plating issues, cracked or loose evaporator frame or frame gasket defects. If no defects are found, thoroughly clean the evaporator. Exceptionally dirty evaporators will require cleaning with a scrub brush.
5. If the cubes are not melted, confirm the line set outside diameter is correct (see page 34)the lineset is installed correctly (see page 37) and no kinks exist in the tubing.
6. Record and verify ambient temperature is within guidelines:
 - A. Air temperature entering condenser page 29
 - B. Water temperature entering the ice machine page 33

7. Refer to chart and record refrigeration operating data.

Freeze Data*	HP¹	LP²	LLT³
1 minute after water starts flowing over the evaporator			
Middle of the freeze cycle			
End of the freeze cycle			

Harvest Data*	HP¹	LP²	LLT³
30 seconds into harvest			
2.5 minutes into harvest			
Dual Evaporators – after first evaporator and before the second evaporator drops ice			

*Record Total Freeze Time and Harvest time

¹ High side refrigeration system pressure at the ice machine discharge line

² Low side refrigeration system pressure taken at the ice machine suction line

³ Liquid line temperature at the ice machine - T1 on touchscreen (service/diagnostics/temperature sensors)

FAILURE TYPE AND SYMPTOMS:

Refrigerant overcharge page 171

Measured in the freeze cycle

- a. Head pressure is above or on the high end of the published numbers
- b. Sub cooling will be greater than 25°F.

Head Pressure Control Valve failure in the freeze cycle page 161

Measured in the freeze cycle

- a. Head pressure is floating up and down
- b. Liquid line temperature floats up and down
- c. Fan cycle control turns condenser fan motor on/off - This symptom will not be observed at temperatures above 70°F.

Head Pressure Control Valve failure in harvest page 161

Measured in the harvest cycle

- a. Liquid line temperature is low
- b. 30 seconds into harvest there will be a temperature difference that can be detected by touch between the discharge port and receiver port on the Head Pressure Control Valve.

Harvest valve failure

Measured in the harvest cycle

- a. High pressure will be higher
- b. Low pressure will be lower than published.

Fan cycling control failure page 156

Measured in the harvest cycle

- a. Condenser fan motor does not cycle off when pressure is below fan cycle control cut out setting .

Accumulator failure page 167

Measured in the freeze cycle

- The suction line temperature between the accumulator and compressor does not increase 20+°F within 6 minutes of a freeze cycle . The test must be run after a harvest cycle has been completed.

SYMPTOM #3 ICE MACHINE WILL NOT HARVEST - FREEZE CYCLE NORMAL, CUBES ARE NOT MELTED

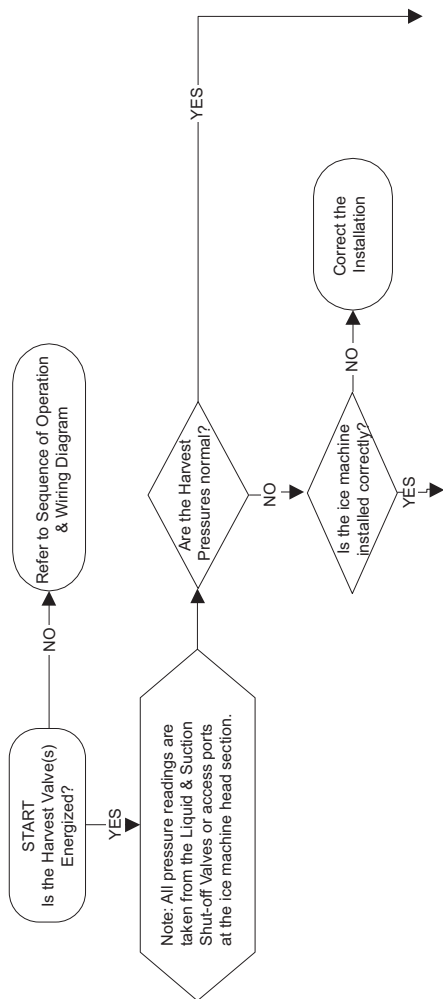

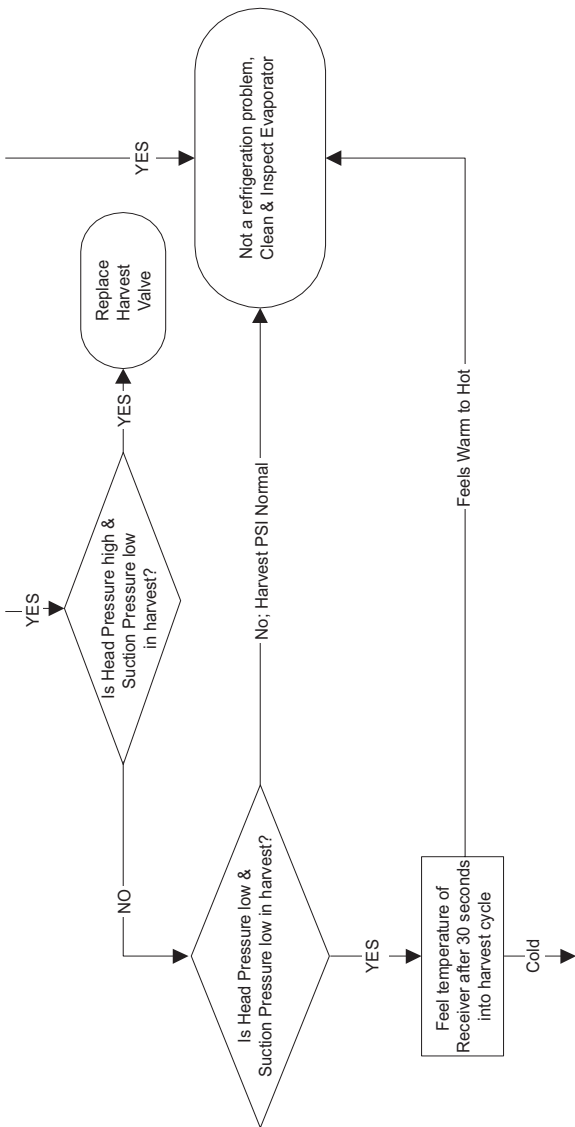

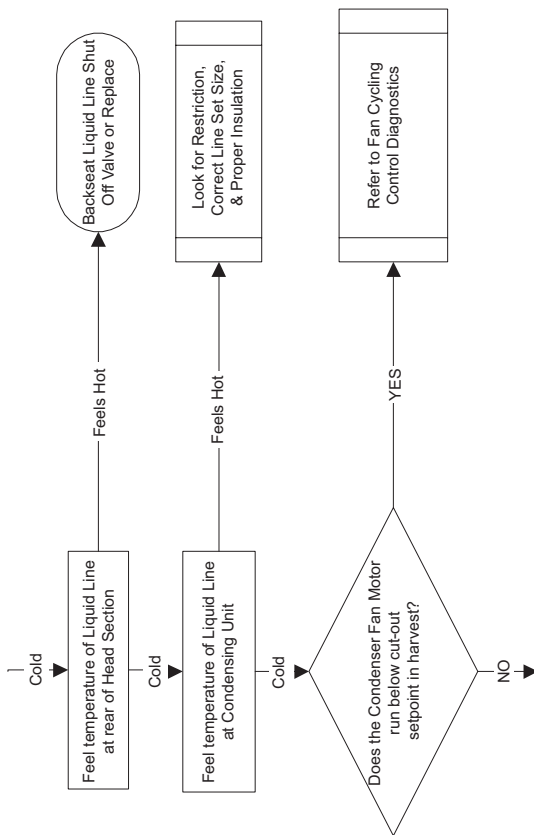

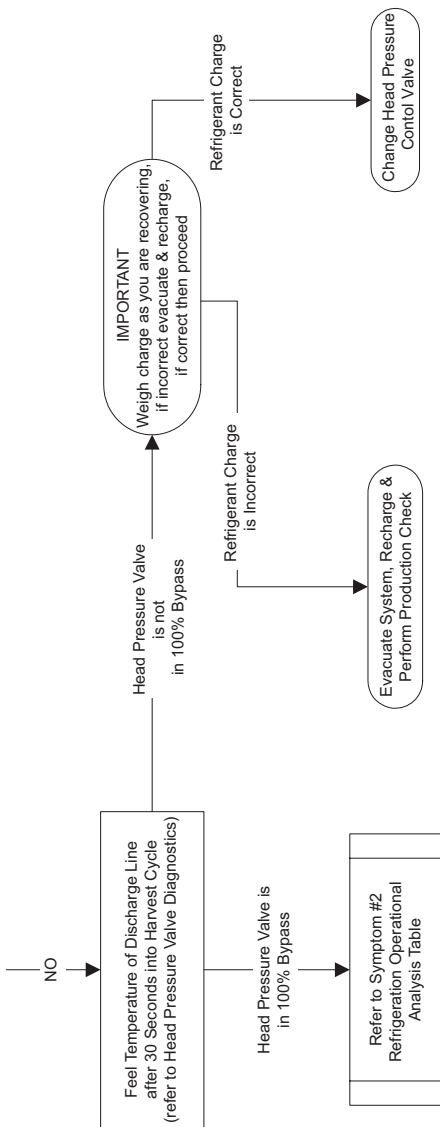

SYMPTOM #4 ICE MACHINE WILL NOT HARVEST - FREEZE CYCLE IS NORMAL AND ICE CUBES ARE MELTED AFTER HARVEST

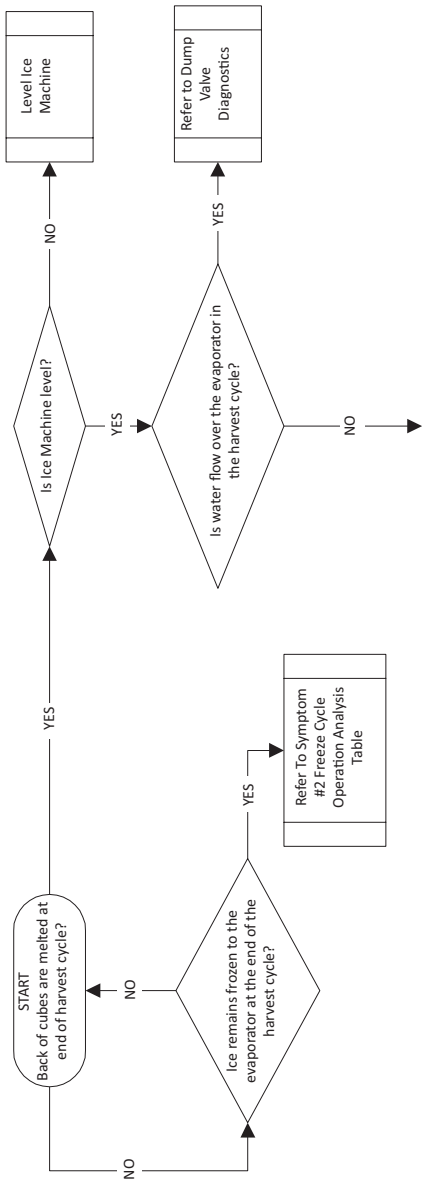

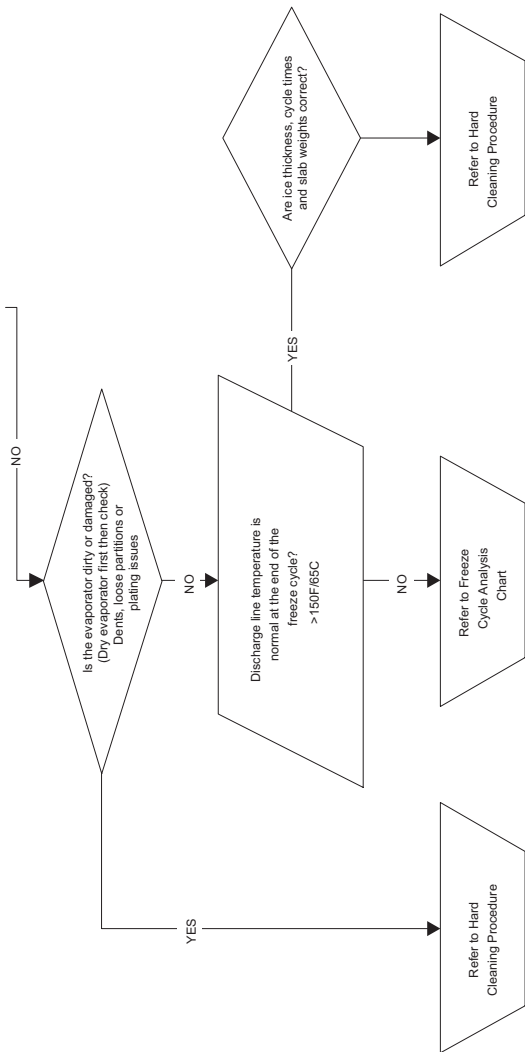

Component Check Procedures

CONTROL BOARD, DISPLAY AND TOUCHSCREEN

FUNCTION

The control board, display and touchscreen provide user input and control the ice machine sequence of operation.

NOTE: Anytime power is supplied to wires #55 & #56 on the control board, the “Display” and “Micro” lights will flash on and off randomly. The two green lights are located on the top corner of the control board.

Display Diagnostics

Symptom - Micro light flashes and display light is off.

1. Reboot ice machine by disconnecting power for a minimum of 15 seconds, reapplying power and checking micro light for normal flashing.
2. Disconnect the display module communication cable from the control board and inspect for damaged or corroded pins. Reconnect after inspection
3. Press the power button on the display and watch the green Display light on the control board.
 - A. Display light flashes- Test run ice machine.
 - B. Display light is off - Replace display/touchscreen assembly.

Control Board Diagnostics

1. Micro light is not flashing.
2. Disconnect line voltage power supply to the ice machine and wait a minimum of 15 seconds, then reapply power.
 - A. Micro light flashes - continue with step 3.
 - B. Micro light is off - Test fuse for continuity. If fuse tests good replace control board.
3. Perform a control board self-test.
 - Menu / Service / Diagnostics / Control Board / Self Check

The control board performs a self test. As the test progresses the display will show pass or fail as the tests are completed.

- Status passed -The control board is functioning normally, continue with touchscreen diagnostics on next page.
- Status failed - Replace control board.

Touchscreen Diagnostics

Verify touchscreen is unlocked prior to performing diagnostics.

1. Navigate to User Interface on the display and perform the on-screen instructions.
 - Menu / Service / Diagnostics / User Interface.

NOTE: During screen calibration it is important to touch and hold down the cross hairs for three seconds at a time.

2. The calibration will either pass or fail. If the touchscreen fails calibration and will not function correctly in other menu functions replace the touchscreen module.

NOTE: Verify you have followed all of the instructions for screen calibration. Skipping steps will result in a failed calibration message.

Bypassing the Touchscreen

The ice machine can be run without a touchscreen by pressing the Display Bypass button on the control board. This will allow time to order and replace the defective touchscreen.

1. Verify touchscreen is not locked.
2. Disconnect the touchscreen from the control board.
3. Wait a minimum of 30 seconds for the display bypass button on the control board to become active.
4. Press the display bypass button and the "Display Bypass Active" LED will energize and the ice machine will start ice making.

NOTE: Pressing the display bypass button again will stop ice making. Pressing again to restart ice making.

5. The ice machine will run for 500 ice making cycles and then stop (approximately 7 days of run time). After the 500 cycles have completed, pressing the test button again will start another 7 days of ice making.

CONTROL BOARD RELAY TEST

The control board can be set to energize all relays for 3.5 minutes. This allows testing to verify control board relays are closed and line voltage is available for ice machine components - Water pump, dump valve, water inlet valve, harvest valve(s), air compressor(s), contactor/compressor/fan motor - The fan cycle control must close to energize the fan motor.

1. Press Power button to turn off ice machine and navigate in menu to enable all relays.
 - Menu / Service / Diagnostics / Control Board / Enable All Relays
2. The control board will energize all relays and the red light next to the relay. The red light indicates the relay coil is energized.
3. Test for line voltage at the individual components.
 - A. Line voltage is present and the component is non functional - Replace component
 - B. Voltage is not present at the component - Proceed to step 5
4. Refer to wiring diagram and determine wire location on the 9 pin molex connector for the component you are testing.
5. Check for line voltage at the control board 9 pin molex connector.
 - A. Line voltage at 9 pin connector - Repair wiring to component
 - B. No power at 9 pin connector - Replace control board

PROGRAMMING A REPLACEMENT CONTROL BOARD

Indigo® NXT replacement control boards require the model number to be entered to activate the appropriate look up tables for operation and diagnostic. This can be done two different ways, USB Setup or Manual Setup.

USB Setup - Applicable when the control board is operational and has a mechanical issue such as a sticking relay. The asset data is transferred to the replacement control board from the faulty control board. Refer to page 133 “Exporting Data To A Flash Drive” before installing the replacement board.

Manual Setup - Applicable when the control board is non-operational or data from the faulty board is suspect.

1. Install replacement control board and reapply power.
2. Navigate to control board replacement and follow the on screen prompts:

Menu / Service / Control Board Replacement.

Menu/Service/Control Board Replacement.

NOTE: If a replacement control board is installed into the ice machine without a display and model number.

The “Display Bypass Button” button can still activate the ice making mode without the display. This will allow the ice machine to temporary run until a new display can be installed. Once a new display is installed the correct model number will have to be entered into the ice machine.

USB FLASH DRIVE SPECIFICATIONS AND FORMATTING

Updating firmware on Indigo® NXT model ice machines requires a properly formatted 32 GB or smaller USB flash drive. All USB flash drives must be formatted before use to remove any software programs or files currently on the flash drive.

USB Flash Drive Specifications:

- USB 2 Version
- 32 GB or less capacity
- Fat32 File System

USB Flash Drive Formatting:

Procedure to format a USB flash drive varies with operating system software. Refer to operating system software manufacturer's website for formatting instructions.

EXPORTING DATA TO A FLASH DRIVE

Data can be copied from the control board memory to a flash drive and used to transfer setup and/or cycle data to a replacement control board or to transfer setup information to multiple ice machines. Data may also be requested by service department personnel for analysis or as an aid to troubleshooting. The data files are small and can be attached to an email.

Important

The flash drive must be formatted before using. All files and software on the flash drive are removed during the formatting process.

1. Ensure that the ice machine's power is on.
2. Press the Menu button.
3. Navigate to USB - Menu / Service / USB.
4. Insert the flash drive into the USB port on the ice machine control board. Do not remove flash drive until transfer is complete.
5. Select Export Data (do not remove flash drive until update is complete) and remove USB drive when the transfer is complete.

UPGRADING FIRMWARE WITH A FLASH DRIVE

Important

The flash drive must be formatted before using. All files and software on the flash drive are removed during the formatting process.

1. Drag and drop the files from website or email onto a flash drive, insuring they are not in a folder.
2. Ensure that the ice machine's power is on.
3. Navigate to USB - Menu / Service / USB.
4. Insert the flash drive into the USB port on the ice machine control board. Do not remove flash drive until update is complete).

NOTE: See "Electronic Control Board" on page 212 for USB location.

5. Select Upgrade firmware and remove USB drive when the transfer is complete.

MAIN FUSE

FUNCTION

The control board fuse stops ice machine operation if electrical components fail, causing high amp draw.

SPECIFICATIONS

The main fuse is 250 Volt, 6.3 amp.

Warning

High (line) voltage is applied to the control board (terminals #55 and #56) at all times. Removing the control board fuse or pressing the power button will not remove the power supplied to the control board.

CHECK PROCEDURE

1. If control board lights are energized the fuse is good.

Warning

Disconnect electrical power to the entire ice machine before proceeding.

2. Remove the fuse. Check for continuity across the fuse with an ohmmeter.

Reading	Result
Open (OL)	Replace fuse
Closed (O)	Fuse is good

BIN SWITCH

FUNCTION

Movement of the water curtain/ice dampers control bin switch operation. The bin switch has two main functions:

1. Terminating the Harvest cycle and returning the ice machine to the Freeze cycle. This occurs when the bin switch is opened and closed again within 30 seconds during the Harvest cycle.
2. Automatic ice machine shut-off. If the storage bin is full at the end of a Harvest cycle, the sheet of cubes fails to clear the water curtain/ice dampers and holds it open. After the water curtain/ice dampers are held open for 30 seconds, the ice machine shuts off. The ice machine remains off until enough ice is removed from the storage bin to allow the sheet of cubes to drop clear of the water curtain/ice dampers. As the water curtain/ice dampers swing back to the operating position, the bin switch closes and the ice machine restarts, provide the 5-minute delay has expired.

Important

The water curtain/ice dampers must be ON (bin switch closed) to start ice making.

SPECIFICATIONS

The bin switch is a magnetically operated reed switch. The magnet is attached to the lower right corner of the water curtain and both ends of ice dampers.

The bin switch is connected to a varying D.C. voltage circuit. (Voltage does not remain constant.)

NOTE: Because of a wide variation in D.C. voltage, it is not recommended that a voltmeter be used to check bin switch operation.

Diagnostics

SYMPTOMS

Bin Switch Fails Open

- The ice machine will not start an ice making cycle and the display indicates “Full Bin”.
- The ice machine displays “Full Bin Remove Ice” in the clean cycle.

Bin Switch Fails Closed

- When running a “Long Harvest” alert is displayed and E02 Long Harvest indicated.
- May be off on a E02 Long Harvest.
- The harvest cycle continues after ice opens and closes the ice damper (harvest cycle is 7 minutes).

Erratic Bin Switch Operation

- Abnormally short (less than 30 second) harvest times in the data history screen.
- Occasional large slab of ice in bin due to bin switch terminating harvest and starting another freeze cycle before the ice released.

Ice Damper Binding/Sticking

- Low production (may be intermittent) with no alerts.
- Owner notices the ice machine is off at a time when it is normally running or the ice machine starts a new freeze cycle when bumped.

NOTE: The ice damper may be dragging on the evaporator extrusion. Rounding the inside edge on both ends of the ice damper with sandpaper, a nail file or an emery board will normally resolve this issue.

DIAGNOSTICS

1. Verify bin switch, curtain/damper and curtain/damper magnet are in place and navigate to inputs.
 - Menu/Service/Diagnostics/Inputs
2. Open and close the ice damper(s) repeatedly while observing the display and control board lights.
 - A. Curtain switch cycles open/closed - The display indicates open/closed and the control board light energizes/de-energizes - Bin switch is operating normally
 - B. Curtain switch remains closed, the display indicates closed and control board light remains on - Go to step 3
 - C. Curtain switch remains open, display indicates open and control board light remains off - Go to step 3
3. Disconnect bin switch wire from control board.
4. Jumper control board bin switch wire to ground, press the power button and observe the display and control board lights.
 - A. Curtain switch closes, display indicates closed, control board light energizes and the ice machine starts - Replace bin switch
 - B. Curtain switch remains open, display indicates open and the control board light is off - Verify procedure was correctly followed - Replace control board

WATER LEVEL CONTROL CIRCUITRY

FUNCTION

The water level probe controls the water level by sensing whether water is or is not contacting the water level probe. The water level probe has three sensing probes. Two probes are equal in length and are used to measure conductivity for diagnostics. Factory default settings measure resistance from both long probes to the short probe.

SPECIFICATIONS

Freeze Cycle Water Level Setting

The water level is not adjustable. If the water level is incorrect, check the water level probe position. Reposition or de-scale/sanitize the probe as necessary.

Water Inlet Valve Safety Shut-Off

In the event of a water level probe failure, this feature limits the maximum amount of time the water inlet valve can remain.

SINGLE EVAPORATOR MODELS

Regardless of the water level probe input, the control board automatically shuts off the water inlet valve if it remains on for 12.5 continuous minutes (30 seconds in prechill and two 6 minute periods in the freeze cycle). Initial cycle is 14 minutes and 12.5 minutes thereafter.

DUAL EVAPORATOR MODELS

Regardless of the water level probe input, the control board automatically shuts off the water inlet valve if it remains on for 16.5 continuous minutes (30 seconds in prechill and two 8 minute periods in the freeze cycle). Initial cycle is 18 minutes and 16.5 minutes thereafter.

PRECHILL & FREEZE CYCLE OPERATION

The water inlet valve energizes and de-energizes in conjunction with the water level probe located in the water trough.

- The water inlet valve is ON when there is no water in contact with the water level probes.
- The water inlet valve turns OFF after water contacts the water level probes for 6 continuous seconds.
- The water inlet valve can cycle ON and OFF once in the prechill and up to two times in the freeze cycle.
- Maximum fill time in the freeze cycle is:
Single evaporator 12 minutes
Dual evaporator 16 minutes

The water inlet valve energizes in the Prechill cycle and will de-energize if water touches the high level probe (in most instances the water trough can't fill in the prechill cycle and the water inlet valve will remain energized into the freeze cycle). The water inlet valve will remain energized until water contacts the high water probe. The water inlet valve will cycle ON, and then OFF one more time to refill the water trough. The water inlet valve is now OFF for the duration of the freeze cycle.

REVERSE OSMOSIS OR DEIONIZED WATER USAGE

When using water with low total dissolved solid content (low TDS) the water level probe sensitivity can be increased by moving the jumper over one pin (refer to "Electronic Control Board" on page 212) for location.

The Electronic Control Board diagrams shows the default position of the jumper covering the left and center pins. Moving the jumper to the center and right pins and enabling R.O. menu "Use less water with reverse osmosis" will increase the sensitivity of the water level probe.

Diagnostics

Important

The following occurs when the reverse osmosis (R.O.) option has been enabled and then disabled (i.e. placed back into factory default) and the jumper has not been reset to the 45 second factory default position.

- A. The higher water level probe sensitivity will remain active see “Reverse Osmosis or Deionized Water Usage” on page 140.
- B. The control board will generate Water-Level probe faults on every cycle.
- C. The control board initiates a “Safe-Mode” every other cycle.

Check real time data

1. Navigate to Menu/Service/Diagnostics/Inputs
2. Focus on Water LVL Low and Water LVL High display
 - Not sensing displayed: indicates not touching water.
 - Sensing displayed: Indicates touching water.

NOTE: If using reverse osmosis or deionized water, increase sensitivity by moving the jumper over one pin (refer to “Electronic Control Board” on page 212) and enabling R.O. menu “Use less water with reverse osmosis”.

3. Disconnect the water level probe wiring harness from the control board and ohm harness and water level probe. Normal readings will show no resistance.

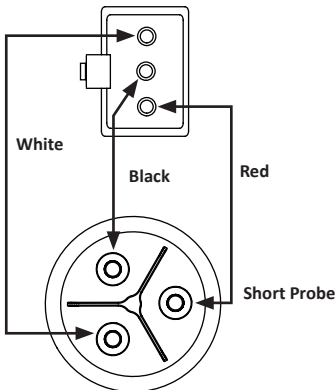

Ohm water Level Probe and Wiring Harness

WATER LEVEL PROBE CIRCUIT CHECK AT CONTROL BOARD

Wait until prefill cycle starts, then jumper water level probe connections (Red/Black) on the control board.

- A. Sensing displays and the water stops. Repair wire or replace water level probe.
- B. Not Sensing displays and the water continues to flow. Replace control board.

ICE THICKNESS PROBE (INITIATES HARVEST)

FUNCTION

The ice thickness probe senses ice on the evaporator and signals the control board to start a harvest cycle.

SPECIFICATIONS

Freeze Time Lock-In Feature

The ice machine control system incorporates a 6 minute freeze time lock-in feature.

Maximum Freeze Time

The maximum freeze time is 35 minutes at which time the control board automatically initiates a harvest sequence.

Maximum Temperature

Maximum temperature for the ice thickness probe is 120°F (49°C). Do not clean probe in a dishwasher or expose to temperatures above the maximum.

Ice Thickness Check

The ice thickness probe is factory-set to maintain the ice bridge thickness at 1/8 in. (3 mm).

NOTE: Make sure the water curtain/splash shields are in place when performing this check. It prevents water from splashing out of the water trough. Remove the curtain to make an adjustment, then replace immediately after the adjustment is made. Make adjustment only when the ice machine is off to prevent initiating a harvest

1. Inspect the bridge connecting the cubes. It should be about 1/8 in. (3 mm) thick.
2. If adjustment is necessary, turn the ice thickness probe adjustment screw clockwise to increase bridge thickness or counterclockwise to decrease bridge thickness. Set a 9/32" gap between the flat of the ice thickness probe and evaporator as a starting point. Then adjust to achieve 1/8" ice thickness.
3. Make sure the ice thickness probe wire and the bracket do not restrict movement of the probe.

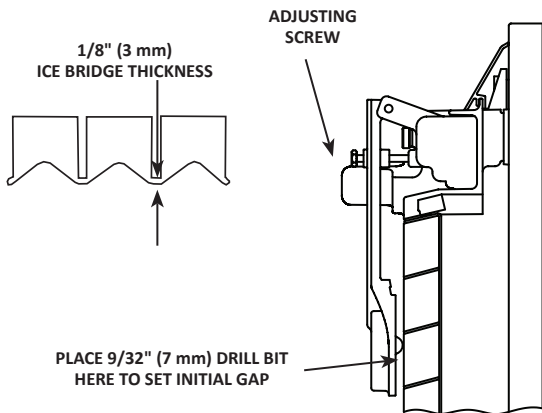

Ice Thickness Adjustment

Ice Thickness Probe Diagnostics

1. Perform Control Board Self Check and insure the internal ITP circuit passes before proceeding.
(Menu/Service/Diagnostics/Control Board/Self Check)
 - Ice Thickness Circuit: Pass = Continue with step #2.
 - Ice Thickness Circuit: Fail = Change control board.
2. Remove all ice from the evaporator when present, by initiating a manual harvest in the service menu.
3. Press the power button and turn off the ice machine.
4. Disconnect power to the ice machine at the main disconnect.
5. Inspect the ice thickness probe for physical damage. On the face of the probe look for bulging, cracks around the nipple and deformed pivot pins or pivot pin arms.
6. Verify the ice thickness probe gap is approximately 9/32" (7 mm) and the ice thickness probe wire and bracket do not restrict movement of the probe. See "Ice Thickness Probe (Initiates Harvest)" on page 143.
7. Reapply power to the ice machine at the main disconnect and confirm the ice machine is off.
8. Navigate to Real Time data (Menu/Service/Data/Real Time data/Inputs) and observe ITP FFT 100 Hz & 120 Hz.
9. Observe the initial number range and perform a tap test.
 - Remove the water curtain or splash shield if present.
 - Lift the ice thickness probe and carefully tap the nipple on the face of the probe for at least 10 seconds.

NOTE: When performing tap test:

- Pass = ITP is not the problem
- Fail = Check DC Voltage on the control board

The initial numbers displayed are constantly changing and are less than 3000.

When the initial reading is 300 or lower and the tap test reading exceeds the initial reading by 3000 or more, the ice thickness probe and control board are both operating correctly.

The initial numbers displayed do not change or initial numbers did not increase by 3000 during tap test.

- Verify the ice thickness probe connector is properly plugged into the board and the ice thickness probe wiring is correct. If the wiring is incorrect replace the ice thickness probe.

J11 Connector On Control Board	
Pin 1 (+)	Red
Pin 2 (-)	Black
Pin 3	Twisted Wire

10. Unplug the ice thickness probe and set a VOM to DC voltage scale - Measure voltage across Pin 1 (+) Red Wire and Pin 2 (-) Black Wire. Refer to "Electronic Control Board" on page 212 for location.
 - A. Voltage measures 3.25 to 3.35 VDC = Replace ice thickness probe.
 - B. Voltage does not measure 3.25 to 3.35 VDC = Replace the control board.

HARVEST TEST

1. Press the power button to start an ice making cycle.
Remove water curtain or splash guard when present.
2. Remove the ice thickness probe, rotate and remount with the nipple facing away from the evaporator.
3. Press the Menu button, scroll down to “Service”, press the right arrow, scroll down to “RealTimeData”, press the right arrow, scroll down to “Inputs”, press the right arrow and then scroll down to “Ice Sense”.
4. Wait until 6.5 minutes into the freeze cycle. Refer to Sequence of Operation starting on for details.
5. Scratch the ice thickness probe nipple for approximately 30 seconds.

HARVEST CYCLE STARTS AND “ICE SENSE” CHANGES FROM NO TO YES

The ice thickness probe and control board are operating normally.

- Initiate a manual harvest cycle to remove ice from the evaporator.
- Press the power button and turn off the ice machine.
- Remove the ice thickness probe, rotate and remount with the nipple facing the evaporator. Set the ice thickness probe gap to 9/32” (7 mm). Confirm the cable is not twisted or binding and the ice thickness probe swings freely, then re-install the water curtain.
- Perform an “Ice Thickness Check” and test run the ice machine two cycles.

HARVEST CYCLE DOES NOT START

- If the control board fails to initiate a harvest cycle replace the control board and perform “Ice Thickness Check”.

BIN LEVEL PROBE

The bin level probe accessory will place the ice machine in a full bin state when ice lowers the temperature to 36°F or less. The touchscreen will display Program Mode On during the full bin state. A lower ice level in dispensers will prevent overfilling or dispense wheel or motor damage.

- The bin probe reads actual temperature and must be connected to the T5 terminal on the control board.
- The control board recognizes the bin level probe automatically when installed. If the bin level probe has not been recognized by the control board, restore factory defaults and run the startup wizard.

Normal Operation

The control board will initiate a full bin cycle and a 5 minute time delay when both of the following occur:

1. The control board receives a temperature input of 36°F or less from the bin probe (T5 thermistor) at the end of the freeze cycle.
2. The temperature reading remains at or below 36°F throughout the entire harvest cycle.

The ice machine will restart when the delay period ends and the bin probe reads 37°F or higher. Ice making will resume at the Initial Start-Up or Start-Up After Automatic Shut-Off (See “Sequence of Operation” on page 72).

Troubleshooting:

Refer to normal operation before troubleshooting - The T5 thermistor reading must indicate 36°F or less in the freeze cycle and throughout the harvest cycle to shutoff on full bin at the end of the harvest cycle.

View the T5 thermistor temperature on the touchscreen (menu/service/diagnostics/temperatures).

PROBE SHORTED - TEMPERATURE DISPLAYED IS ABOVE 400°F:

A shorted bin level probe wire/thermistor will indicate a temperature higher than 400°F. This issue will result in the ice machine only stopping on full bin when the bin switch (curtain) is open at the end of a harvest cycle. The ice machine will restart when the curtain closes.

PROBE OPEN - TEMPERATURE DISPLAYED READS -22°F

A shorted bin level probe wire/thermistor will indicate a temperature lower than -10°F. This issue will result in the ice machine only stopping on full bin when the bin switch (curtain) is open at the end of a harvest cycle. The ice machine will restart when the curtain closes.

PROBE OUT OF RANGE - TEMPERATURE READS LOWER OR HIGHER THAN THE ACTUAL TEMPERATURE AT THE BIN LEVEL PROBE

An out of range thermistor can indicate a temperature higher or lower than the actual temperature at the bin level probe location.

1. Verify actual temperature at the bin level probe location with a thermometer.
2. Refer to "Thermistor Test" on page 152.

THERMISTORS

FUNCTION

Thermistor resistance values change with temperature. The value supplied to the control board is used to identify temperature at the thermistor location.

SPECIFICATIONS

Temperature of Thermistor		Resistance
°C	°F	K Ohms (x 1000)
-30° - -20°	-22° - -4°	820.85 - 466.35
-20° - -10°	-4° - 14°	466.35 - 269.05
-10° - 0°	14° - 32°	269.05 - 160.70
0° - 10°	32° - 50°	160.70 - 98.930
10° - 20°	50° - 68°	98.930 - 62.015
20° - 30°	68° - 86°	62.015 - 39.695
30° - 40°	86° - 104°	39.695 - 25.070
40° - 50°	104° - 122°	25.070 - 17.481
50° - 60°	122° - 140°	17.481 - 11.860
60° - 70°	140° - 158°	11.860 - 8.1900
70° - 80°	158° - 176°	8.1900 - 5.7530
80° - 90°	176° - 194°	5.7530 - 4.1015
90° - 100°	194° - 212°	4.1015 - 2.9735
100° - 110°	212° - 230°	2.9735 - 2.1885
110° - 120°	230° - 248°	2.1885 - 1.6290
120° - 130°	248° - 266°	1.6290 - 1.2245
130° - 140°	266° - 284°	1.2245 - 0.9319
140° - 150°	284° - 302°	0.9319 - 0.7183
150° - 160°	302° - 320°	0.7183 - 0.5624
160° - 170°	320° - 338°	0.5624 - 0.4448
170° - 180°	338° - 356°	0.4448 - 0.3530
180° - 190°	356° - 374°	0.3530 - 0.2831
190° - 200°	374° - 392°	0.2831 - 0.2273

Thermistor Matrix

Four thermistors are standard on the ice machine. They are labeled T1, T2, T3, T4. Three additional thermistors are available as an option and measure ice bin level, potable water supply temperature and air temperature entering the condenser.

TEMPERATURE SENSOR LOCATION

Models with 1 evaporator, 1 evaporator circuit

See page 214 for graphic

T1 - Receiver Inlet

T2 - Receiver Outlet

T3 - Evaporator Inlet

T4 - Evaporator Outlet

Models with 1 evaporator, 2 evaporator circuits

See page 216 for graphic

T1 - Receiver Inlet

T2 - Receiver Outlet

T3 - Evaporator Outlet for second evaporator circuit

T4 - Evaporator Outlet for first evaporator circuit

Models with 2 evaporators, 1 circuit

See page 218 for graphic

T1 - Receiver Inlet

T2 - Receiver Outlet

T3 - Evaporator Outlet for second evaporator circuit

T4 - Evaporator Outlet for first evaporator circuit

Models with 2 evaporators, 2 circuits

See page 220 for graphic

T1 - Receiver Inlet

T2 - Receiver Outlet

T3 - Evaporator Outlet for second evaporator circuit

T4 - Evaporator Outlet for first evaporator circuit

SYMPTOM

The alert log indicates a T1, T2, T3, or T4 Fault.

CHECK PROCEDURE

NOTE: Navigate to Menu/Service/Data/Real Time data/Time & Temperature

NOTE: An open thermistor will display -10°F (-23°C) and a shorted thermistor displays 400°F (204°C).

Thermistor Test

1. Disconnect the suspect thermistor from the control board and swap with another thermistor.
 - A. The symptoms move with the thermistor - Replace the thermistor.
 - B. The symptom does not change - Perform control board test.

Control Board Test

1. Disconnect thermistor from control board - The display temperature reading, dropping to -10°F (-23°C) indicates the control board is good.
2. Short thermistor pins - The display temperature reading, climbing to 400°F (204°C) indicates the control board is good.

HIGH PRESSURE CUTOUT (HPCO) CONTROL

FUNCTION

Stops the ice machine if subjected to excessive high-side pressure. The HPCO control is normally closed, and opens on a rise in discharge pressure.

SPECIFICATIONS

	Specifications	
	Cut-Out	Cut-In
R404A	450 psig \pm 7 (3102 kPa \pm 48 31 bar \pm 0.48)	300 psig \pm 10 (2068 kPa \pm 69 20.68 bar \pm 0.69)
R410A	600 psig \pm 10 (3147 kPa \pm 69)	450 psig \pm 10 (3103 kPa \pm 69)
Automatic Reset		

Opening the HPCO will initiate the 5 minute compressor time delay. Repeated HPCO opening/closing or failure to close will result in an E01 long freeze error.

CHECK PROCEDURE

1. Connect manifold gauges to ice machine.
2. Hook voltmeter in parallel across the fan cycle control, leaving wires attached.
3. Refer to chart below.

HPCO Setpoint	Reading Should Be	HPCO Contact Position
Below Cut-Out	0 Volts	Closed
Above Cut-In	Line Voltage	Open

LOW PRESSURE CUTOUT (LPCO) CONTROL

FUNCTION

Supplies or interrupts power to the compressor time delay when suction pressure rises above or falls below setpoint.

The LPCO control is closed at pressures above setpoint and opens at pressures below setpoint.

Specifications		
	Cut-Out	Cut-In
R404A	12 psig \pm 3	35 psig \pm 5
R410A	20 psig \pm 3	50 psig \pm 5

CHECK PROCEDURE

Opening the LPCO will initiate the 5 minute compressor time delay relay. Repeated opening/closing or failure to close will result in an E01 long freeze error.

CHECK PROCEDURE

1. Connect manifold gauges to ice machine.
2. Hook voltmeter in parallel across the fan cycle control, leaving wires attached.
3. Refer to chart below.

LPCO Setpoint	Reading Should Be	LPCO Contact Position
Above Cut-In	0 Volts	Closed
Below Cut-Out	Line Voltage	Open

COMPRESSOR TIME DELAY

FUNCTION

Supplies or interrupts power to the compressor contactor coil. The time delay starts whenever line voltage is removed/reapplied; The contact closes when the delay period ends.

Specifications	
Contact	Delay Period
SPST Normally open	300 seconds (5 minutes) +35%/-15%

CHECK PROCEDURE

1. Verify line voltage is supplied to the condensing unit.
2. Disconnect/reconnect power to the condensing unit and test for line voltage at terminals 2 & 3.

Line Voltage at Terminals 2 & 3?	
Yes	Proceed To Next Step
No	Verify HPCO & LCPO are closed

3. Wait 5 minutes for the delay period to expire then test for line voltage at terminals 1 & 3.

Line Voltage at Terminals 1 & 3?	
Yes	Time Delay is operating correctly
No	Verify the delay time has expired Verify the HPCO & LPCO are not momentarily opening/closing during the delay period Replace the time delay

FAN CYCLE CONTROL

FUNCTION

Cycles the fan motor on and off to maintain proper operating discharge pressure.

The fan cycle control closes on an increase, and opens on a decrease in discharge pressure.

SPECIFICATIONS

Specifications		
Model	Cut-In (Close)	Cut-Out (Open)
CVDF0600 CVDF0900 CVDF1400 CVDF1800 CVDF2100	250 psig ± 5 (1723 kPa ± 34) (17.23 bar $\pm .34$)	200 ± 5 (1517 kPa ± 34) (15.17 bar $\pm .34$)
CVDT1200	335 psig ± 5 2310 kPa ± 34 (23.10 bar $\pm .34$)	275 psig ± 5 1896 kPa ± 34 (18.96 bar $\pm .34$)

CHECK PROCEDURE

1. Verify fan motor windings are not open or grounded, and fan spins freely.
2. Connect manifold gauges to ice machine.
3. Hook voltmeter in parallel across the fan cycle control, leaving wires attached.
4. Refer to chart below.

FCC Setpoint:	Reading Should Be:	Fan Should Be:
Above Cut-In	0 Volts	Running
Below Cut-Out	Line Voltage	Off

HARVEST ASSIST AIR PUMP

FUNCTION

The air pump helps break the vacuum between the sheet of ice and the evaporator which results in shorter harvest cycles.

SPECIFICATIONS

115 Volt or 230 Volt - matches the ice machine voltage.

CHECK PROCEDURE

1. The air pump is wired in parallel with the harvest valve - Verify the ice machine is in the harvest cycle and the harvest valve is energized.
2. If there is voltage at the air pump connector, use a volt ohm meter to verify there is no continuity through the motor windings then replace air pump.

COMPRESSOR ELECTRICAL DIAGNOSTICS

The compressor does not start or will trip repeatedly on overload.

Check Resistance (Ohm) Values

NOTE: Compressor windings can have very low ohm values. Use a properly calibrated meter.

Perform the resistance test after the compressor cools. The compressor dome should be cool enough to touch (below 120°F/49°C) to assure that the overload is closed and the resistance readings will be accurate.

SINGLE PHASE COMPRESSORS

1. Disconnect power then remove the wires from the compressor terminals.
2. The resistance values between C and S and between C and R, when added together, should equal the resistance value between S and R.
3. If the overload is open, there will be a resistance reading between S and R, and open readings between C and S and between C and R. Allow the compressor to cool, then check the readings again.

THREE PHASE COMPRESSORS

1. Disconnect power and remove the wires from the compressor terminals.
2. The resistance values between L1 and L2, between L2 and L3, and between L3 and L1 should all be equal.
3. If the overload is open, there will be open readings between L1 and L2, between L2 and L3, and between L3 and L1. Allow the compressor to cool, then check the readings again.

CHECK MOTOR WINDINGS TO GROUND

Check continuity between all three terminals and the compressor shell or copper refrigeration line. Scrape metal surface to get good contact. If continuity is present, the compressor windings are grounded and the compressor should be replaced.

COMPRESSOR DRAWING LOCKED ROTOR

To determine if the compressor is seized, check the amp draw while the compressor is trying to start.

The two likely causes of this are a defective starting component or a mechanically seized compressor.

To determine which you have:

1. Install high and low side gauges.
2. Try to start the compressor.
3. Watch the pressures closely.
 - A. If the pressures do not move, the compressor is seized. Replace the compressor.
 - B. If the pressures move, the compressor is turning slowly and is not seized. Check the capacitors and relay.

COMPRESSOR DRAWING HIGH AMPS

The continuous amperage draw on start-up should not be near the maximum fuse size indicated on the serial tag.

DIAGNOSING START COMPONENTS

If the compressor attempts to start, or hums and trips the overload protector, check the start components before replacing the compressor.

Capacitor

Visual evidence of capacitor failure can include a bulged terminal end or a ruptured membrane. Do not assume a capacitor is good if no visual evidence is present. A good test is to install a known good substitute capacitor. Use a capacitor tester when checking a suspect capacitor. Clip the bleed resistor off the capacitor terminals before testing.

Relay

The relay has a set of contacts that connect and disconnect the start capacitor from the compressor start winding. The contacts on the relay are normally closed (start capacitor in series with the start winding). The relay senses the voltage generated by the start winding and opens the contacts as the compressor motor starts. The contacts remain open until the compressor is de-energized.

RELAY OPERATION CHECK

1. Disconnect wires from relay terminals.
2. Verify the contacts are closed.
Measure the resistance between terminals 1 and 2.
No continuity indicates open contacts. Replace the relay.
3. Check the relay coil.
Measure the resistance between terminals 2 and 5.
No resistance indicates an open coil. Replace the relay.

Refrigeration Components

HEAD PRESSURE CONTROL VALVE

Manitowoc remote systems require head pressure control valves with special settings. Replace defective head pressure control valves only with “original” Manitowoc replacement parts.

Refrigerant Charge Verification

The correct amount of refrigerant (name plate charge) is required to operate correctly at all ambient conditions.

An ice machine with an overcharge or undercharge of refrigerant may function properly at higher ambient temperatures and fails at lower ambient temperatures.

Symptoms of incorrect refrigerant amount are:

- Works during the day and malfunctions at night, and/or fails whenever the outdoor temperature drops.
- A service fault is stored in control board memory.

Refrigerant loss and ambient temperature are directly related to each other. As the ambient temperature drops, more refrigerant is stored in the condenser.

When the refrigerant charge and ambient temperature create an undercharge of refrigerant in the freeze cycle, the receiver dip tube will lose its liquid seal. Without liquid refrigerant to the TXV, the ice machine fails to make a full sheet of ice in 35 minutes and a E01 Long Freeze results.

NOTE: When a head pressure control valve is being replaced or refrigerant charge is suspected, verify the refrigerant charge is correct by recovering the refrigerant, weighing and comparing to the nameplate amount. Refer to “Recovery/Evacuation Procedures” for recovery procedures.

Freeze Cycle Operation All Models

The head pressure control valve is non adjustable.

At ambient temperatures of approximately 70°F (21°C) or above, refrigerant flows through the valve from the condenser to the receiver inlet. At temperatures below this (or at higher temperatures if it is raining), the head pressure control dome's nitrogen charge closes the condenser port and opens the bypass port from the compressor discharge line.

In this modulating mode, the valve maintains minimum head pressure by building up liquid in the condenser and bypassing discharge gas directly to the receiver.

Harvest Cycle Operation

During the Harvest cycle, the harvest valve opens and allows refrigerant from the top of the receiver tank to enter the evaporator. The refrigerants change of state (from vapor to liquid) releases the heat necessary for the Harvest cycle.

Opening the harvest valve causes a drop in discharge pressure.

The discharge pressure will drop below the condenser fan cycling control setpoint and the condenser fan motor cycles off (at ambient temperatures above 110°F (43°C) the condenser fan motor remains energized).

The warm discharge gas adds heat to the receiver in the harvest cycle. Without this additional heat the head pressure would continue to drop as liquid refrigerant boils off in the receiver.

Example: A service technician removes refrigerant vapor from a cylinder by boiling off the liquid refrigerant. A refrigeration effect is created as the refrigerant changes state from a liquid to a vapor. The cylinder cools and the refrigerant pressure drops. To maximize flow and maintain pressure the technician places the cylinder in warm water.

Diagnostics

FREEZE CYCLE - QUIETQUBE® REMOTE

CONDENSING UNIT

1. Determine if the coil is clean.
2. Determine the air temperature entering the condenser.
3. Determine if the head pressure is high or low in relationship to the outside temperature. (Refer to the proper "Cycle Times/24-Hour Ice Production/Refrigerant Pressure Charts" on page 181.)
4. Determine the temperature of the liquid line entering the receiver by feeling it. This line is normally warm; "body temperature."
5. Using the information gathered, refer to the chart.

NOTE: A head pressure control valve that will not bypass, will function properly with condenser air temperatures of approximately 70°F (21°C) or above. When the temperature drops below 70°F (21°C), the head pressure control valve fails to bypass and the ice machine malfunctions. Lower ambient conditions can be simulated by rinsing the condenser with cool water during the freeze cycle.

Condition	Probable Cause	Corrective Measure
Discharge Pressure - High Liquid Line Temperature - Hot	Valve stuck in bypass	Replace valve
Discharge Pressure - Low Liquid Line Temperature - Cold	Valve not bypassing	Replace valve
Discharge Pressure - Low Liquid Line Temperature - Hot	Ice Machine Low on Charge	Refrigerant Charge Verification

Harvest Cycle

QUIETQUBE® REMOTE CONDENSING UNIT

QuietQube® ice machines may fail in the harvest cycle when the refrigerant charge and ambient temperature create a marginal undercharge of refrigerant. The ice machine may be able to make a full sheet of ice, but fails in the harvest cycle when the receiver runs out of liquid refrigerant. A E02 Long Harvest will result when the ice machine is unable to harvest.

Undercharge Symptoms

- E01 Long Freeze or E02 Long Harvest in control board memory, a flashing triangle alert and Long Freeze or Long Harvest is displayed.
- Harvest cycle suction pressure is low.
- Harvest cycle discharge pressure is low.
- Liquid line entering receiver feels warm to hot in the freeze cycle.

Overcharge Symptoms

- E02 Long Harvest in control board memory, a flashing triangle alert and after pressing left arrow Long Harvest is displayed.
- Harvest cycle discharge pressure is normal.
- Freeze cycle time, suction and discharge pressure are normal and the ice machine will not harvest. The sheet of ice cubes show little or no sign of melting when removed from the evaporator after the harvest cycle has been completed. (If the cubes are melted you have a release problem, de-scale/sanitize the ice machine.)

HARVEST CYCLE DIAGNOSTICS QUIETQUBE® REMOTE CONDENSING UNIT

The head pressure control valve diverts the compressor discharge gas to the ice machine receiver in the harvest cycle. All refrigerant flow through the condenser in the harvest cycle stops. Symptoms of a head pressure control valve that will not seat 100% closed (completely bypass the condenser) in the harvest cycle are:

- Freeze cycle suction and discharge pressure are normal.
- The control board indicates E02 Long Harvest, a flashing triangle alert and after pressing left arrow Long Harvest is displayed. The failure seems to be temperature related. Example: The ice machine may function correctly at temperatures above 32°F but fails at temperatures below 32°F.
- Harvest cycle suction pressure is low.
- Harvest cycle discharge pressure is normal or slightly low.

Procedure

1. Freeze cycle operation must be normal before diagnosing the head pressure in the harvest cycle. (Refer to Cycle Times/24 hr Ice Production/Refrigerant Pressure Chart)
2. Allow the ice machine to run a normal freeze cycle (do not initiate an early harvest cycle).
3. At the start of the harvest cycle feel the compressor discharge line and the liquid line to the ice machine receiver at the head pressure control valve. The temperature of both lines will be highest at the beginning of the harvest cycle and then decrease. Compare the lines 30 seconds into the harvest cycle.

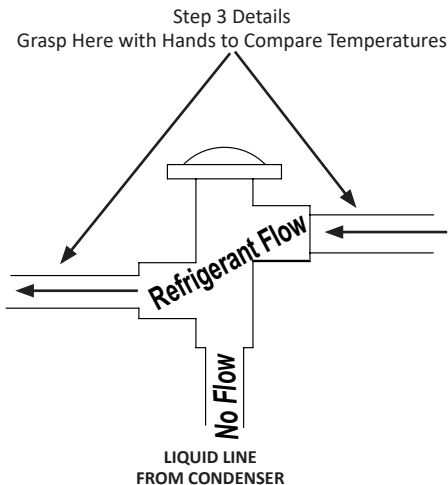

HARVEST CYCLE HEAD PRESSURE CONTROL VALVE FAILURE LIST

Temperature of the compressor discharge line and liquid line to the ice machine receiver feel the same 30 seconds into the harvest cycle.

- The head pressure control valve is functioning correctly.

The compressor discharge line is noticeably warmer than the liquid line to the ice machine receiver.

- Head pressure control valve is not bypassing 100%.
Replace head pressure control valve.

SUCTION ACCUMULATOR OPERATION

Liquid refrigerant collects in the suction accumulator during the harvest cycle and is removed during the freeze cycle. The liquid refrigerant is returned to the compressor through a screen and orifice in the suction accumulator J tube. Passing the liquid through the orifice causes a pressure drop; the liquid flashes to a vapor and creates a refrigeration affect. It is normal to see frost on the accumulator, suction line and compressor suction port in the freeze cycle. The suction accumulator empties within the first 5 minutes of the freeze cycle. When the refrigeration affect ends (liquid refrigerant has been removed), the suction line between the accumulator and compressor will increase in temperature. The suction line temperature increases 20 plus degrees within 2 minutes after the liquid has been removed.

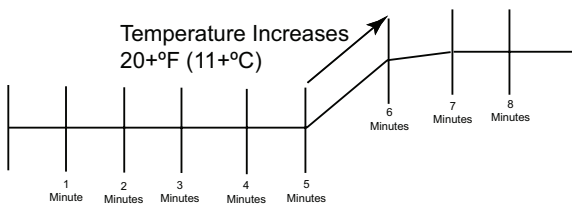

The time needed to remove the liquid refrigerant will vary with the ambient temperature and the length of the harvest cycle. Higher ambient temperatures = shorter harvest cycles, faster removal of liquid refrigerant from the accumulator and greater suction line temperature increases.

Recovery/Evacuation/Charging Procedures QuietQube® Models

Do not purge refrigerant to the atmosphere. Capture refrigerant using recovery equipment. Follow the manufacturer's recommendations.

Notice

Manitowoc Ice assumes no responsibility for the use of contaminated refrigerant. Damage resulting from the use of contaminated refrigerant is the sole responsibility of the servicing company.

Notice

Replace the liquid line drier after recovering the refrigerant and before evacuating and recharging. Use only a Manitowoc (OEM) liquid line filter-drier to prevent voiding the warranty.

Notice

Recovery/evacuation of a QuietQube® remote system requires connections at either 4 or 5 recovery points for complete system recovery/evacuation. Check valves are located in the ice machine head section and the CVD condensing unit. Five point requires connections between the compressor and suction filter access valve, receiver access valve and the high and low side access valves on the front or rear of the ice machine. Four point is required on units that do not have a receiver service valve.

Notice

The receiver access valve (located in the ice machine head section) must be accessed during refrigerant recovery to allow complete removal of the refrigerant charge.

CONNECTIONS

Manifold gauge sets must utilize low loss fittings to comply with U.S. Government rules and regulations.

CVD condensing units with reciprocating compressors are manufactured with a check valve in the compressor discharge line. The check valve requires an additional connection on the condensing unit during evacuation or recovery procedures. Connection of a manifold gauge set (or a hose with core depressors on both ends) between the suction filter access port and the compressor access valve (located between the compressor and discharge line check valve) is required.

Make these connections:

Ice Machine Head Section	CVD Condensing Unit
Receiver Service Valve	Compressor Discharge Access Valve
Low Side Access Valve	Suction Filter Access Valve
High Side Access Valve	

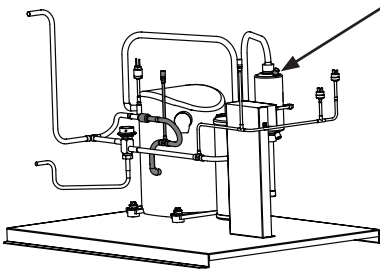

Connections must also be made at two points on condensing unit for complete refrigerant recovery.

RECOVERY/EVACUATION PROCEDURES

1. Press the power button to stop the ice machine and disconnect all power to the ice machine and condensing unit.
2. Install manifold gauges, charging scale, and recovery unit or two-stage vacuum pump.
3. Open high and low side on the manifold gauge set.
4. Perform recovery or evacuation:
 - A. Recovery: Operate the recovery unit as directed by the manufacturer's instructions.
 - B. Pressure test the system.
 - C. Evacuation prior to recharging: Evacuate to 500 microns. Then allow the pump to run for an additional hour.
5. Refer to Charging Procedures.

CHARGING PROCEDURES

1. The ice machine must be off.
2. Close the vacuum pump valve and the low side manifold gauge valve.
3. Open the refrigerant cylinder and add the proper refrigerant charge (shown on nameplate) into the system high side (receiver service valve and discharge line shut-off valve).
4. If the high side does not take the entire charge, close the high side on the manifold gauge set. Start the ice machine and wait until the freeze cycle starts, then add the remaining charge through valves on back of ice making head, or through valves on suction filter.
5. Disconnect the manifold gauge set from the liquid line shut-off valve.
6. Open the high and low side valves on the manifold gauge set. Any refrigerant in the lines will be pulled into the low side of the system.
7. Allow the pressures to equalize while the ice machine is in the freeze cycle.
8. Disconnect the manifold gauge set from the suction line shut-off valve.
9. Install and torque all valve caps

NOTE: Check for refrigerant leaks after all valve caps have been installed.

System Contamination Clean-Up

General

This section describes the basic requirements for restoring contaminated systems to reliable service.

Notice

Routine adjustments and maintenance procedures Manitowoc Ice assumes no responsibility for the use of contaminated refrigerant. Damage resulting from the use of contaminated refrigerant is the sole responsibility of the servicing company.

DETERMINING SEVERITY OF CONTAMINATION

System contamination is generally caused by either moisture or residue from compressor burnout entering the refrigeration system.

Inspection of the refrigerant usually provides the first indication of system contamination. Obvious moisture or an acrid odor in the refrigerant indicates contamination.

If either condition is found, or if contamination is suspected, use a Total Test Kit from Totaline or a similar diagnostic tool. These devices sample refrigerant, eliminating the need to take an oil sample. Follow the manufacturer's directions.

If a refrigerant test kit indicates harmful levels of contamination, or if a test kit is not available, inspect the compressor oil.

1. Remove the refrigerant charge from the ice machine.
2. Remove the compressor from the system.
3. Check the odor and appearance of the oil.
4. Inspect open suction and discharge lines at the compressor for burnout deposits.
5. If no signs of contamination are present, perform an acid oil test.

Chart shows required clean-up.

CONTAMINATION CLEAN-UP CHART	
Symptoms/Findings	Required Clean-up Procedure
No symptoms or suspicion of contamination	Normal evacuation/recharging procedure
Moisture/Air Contamination symptoms Refrigeration system open to atmosphere for longer than 15 minutes Refrigeration test kit and/or acid oil test shows contamination No burnout deposits in open compressor lines	Mild contamination clean-up procedure
Mild Compressor Burnout symptoms Oil appears clean but smells acrid Refrigeration test kit or acid oil test shows harmful acid content No burnout deposits in open compressor lines	Mild contamination clean-up procedure
Severe Compressor Burnout symptoms Oil is discolored, acidic, and smells acrid Burnout deposits found in the compressor, lines, and other components	Severe contamination clean-up procedure

CLEAN-UP PROCEDURE

Mild System Contamination

1. Replace any failed components.
2. If the compressor is good, change the oil.
3. Replace the liquid line drier.

NOTE: If the contamination is from moisture, use heat lamps during evacuation. Position them at the compressor, condenser and evaporator prior to evacuation. Do not position heat lamps too close to plastic components, or they may melt or warp.

Important

Dry nitrogen is recommended for this procedure. This will prevent refrigerant release.

4. Follow the normal evacuation procedure, except replace the evacuation step with the following:
 - A. Pull vacuum to 1000 microns. Break the vacuum with dry nitrogen and sweep the system. Pressurize to a minimum of 5 psig (35 kPa, .35 bar).
 - B. Pull vacuum to 500 microns. Break the vacuum with dry nitrogen and sweep the system. Pressurize to a minimum of 5 psig (35 kPa, .35 bar).
 - C. Change the vacuum pump oil.
 - D. Pull vacuum to 500 microns. Run the vacuum pump for 1 hour.

NOTE: You may perform a standing vacuum test to make a preliminary leak check. You should use an electronic leak detector after system charging to be sure there are no leaks.

5. Charge the system with the proper refrigerant to the nameplate charge.
6. Operate the ice machine.

Severe System Contamination

1. Remove the refrigerant charge.
2. Remove the compressor and inspect the refrigeration lines. If burnout deposits are found, install a new harvest valve and TXV.
3. Wipe away any burnout deposits from suction and discharge lines at compressor.
4. Sweep through the open system with dry nitrogen.

Important

Refrigerant sweeps are not recommended, as they release refrigerant into the atmosphere.

5. Install a new compressor and new start components.
6. Install a suction line filter-drier with acid and moisture removal capability. Place the filter drier as close to the compressor as possible.
7. Install an access valve at the inlet of the suction line drier.
8. Install a new liquid line drier.

Important

Dry nitrogen is recommended for this procedure. This will prevent refrigerant release.

9. Follow the normal evacuation procedure, except replace the evacuation step with the following:
 - A. Pull vacuum to 1000 microns. Break the vacuum with dry nitrogen and sweep the system. Pressurize to a minimum of 5 psig (35 kPa, .35 bar).
 - B. Change the vacuum pump oil.

- C. Pull vacuum to 500 microns. Break the vacuum with dry nitrogen and sweep the system. Pressurize to a minimum of 5 psig (35 kPa, .35 bar).
- D. Change the vacuum pump oil.
- E. Pull vacuum to 500 microns. Run the vacuum pump for 1 hour.

NOTE: You may perform a standing vacuum test to make a preliminary leak check. You should use an electronic leak detector after system charging to be sure there are no leaks.

- 10. Charge the system with the proper refrigerant to the nameplate charge.
- 11. Operate the ice machine for one hour. Then, check the pressure drop across the suction line filter-drier.
 - A. If the pressure drop is less than 1 psig (7 kPa, 0.07 bar), the filter-drier should be adequate for complete clean-up.
 - B. If the pressure drop exceeds 1 psig (7 kPa, 0.07 bar), change the suction line filter-drier and the liquid line drier. Repeat until the pressure drop is acceptable.
- 12. Operate the ice machine for 48-72 hours. Then remove the suction line drier and change the liquid line drier.
- 13. Follow normal evacuation procedures.

LIQUID LINE FILTER-DRIERS

The filter-driers used on Manitowoc ice machines are manufactured to Manitowoc specifications. A Manitowoc drier has dirt-retaining filtration, with fiberglass filters on both the inlet and outlet ends. This is very important because ice machines have a back-flushing action that takes place during every Harvest cycle.

The size of the filter-drier is important. The refrigerant charge is critical. Using an improperly sized filter-drier will cause the ice machine to be improperly charged with refrigerant.

Important

Driers are covered as a warranty part. The drier must be replaced any time the system is opened for repairs.

SUCTION FILTER

The suction filter on QuietQube® CVD condensing units traps particulate only, and do not contain a desiccant. The filter needs replacement when:

1. The pressure drop across the drier exceeds 2 psig.
2. A compressor is replaced.
3. Refrigeration system contains contaminants.

REPLACING PRESSURE CONTROLS WITHOUT REMOVING REFRIGERANT CHARGE

This procedure reduces repair time and cost. Use it when any of the following components require replacement, and the refrigeration system is operational and leak-free.

- Fan cycle control
- High pressure cut-out control
- Low Pressure cut-out control
- High side service valve
- Low side service valve

Important

This is a required in-warranty repair procedure.

1. Disconnect power to the ice machine.
2. Follow all manufacturer's instructions supplied with the pinch-off tool. Position the pinch-off tool around the tubing as far from the pressure control as feasible. (See the figure on next page.) Clamp down on the tubing until the pinch-off is complete.

Warning

Do not unsolder a defective component. Cut it out of the system. Do not remove the pinch-off tool until the new component is securely in place.

3. Cut the tubing of the defective component with a small tubing cutter.
4. Solder the replacement component in place. Allow the solder joint to cool.
5. Remove the pinch-off tool.
6. Re-round the tubing. The pressure controls will operate normally once the tubing is re-rounded. Tubing may not re-round 100%.

Total System Refrigerant Charge QuietQube® CVD Models

Ice machines listed with an F in the model number use R404A refrigerant - Ice machines listed with a T in the model number use R410A. This information is for reference only. Refer to the ice machine model/serial label to verify the system charge and refrigerant type.

Serial plate information overrides the information listed in this chart.

Model	Condensing Unit	Refrigerant Charge	Line Set Length
IF0600C	CVDF0600	10.50 lbs. 4.76 kg.	0-50 ft. 0-15 m
		12.00 lbs. 5.44 kg.	51-100 ft. 15-30 m
IBF0620C	CVDF0600	11.25 lbs 5.10 kg	0-50 ft. 0-15 m
		12.75 lbs 5.78 kg	51-100 ft. 15-30 m
IBF0820C	CVDF900	8.25 lbs. 3.74 kg	0-50 ft. 0-15 m
		10.25 lbs. 4.76 kg	51-100 ft. 15-30 m
IF0900C	CVDF0900	8.25 lbs. 3.74 kg	0-50 ft. 0-15 m
		10.25 lbs. 4.76 kg	51-100 ft. 15-30 m
IBT1020C	CVDT1200	12.25 lbs. 5.55 kg	0-50 ft. 0-15 m
		14.25 lbs 6.35 kg	51-100 ft. 15-30 m
IT1200C	CVDT1200	10.25 lbs 4.76 kg	0-50 ft. 0-15 m
		12.25 lbs 5.55 kg	51-100 ft. 15-30 m
IF1400C	CVDF1400	12.75 lbs. 5.78 kg	0-50 ft. 0-15 m
		14.75 lbs 6.69 kg	51-100 ft. 15-30 m

Model	Condensing Unit	Refrigerant Charge	Line Set Length
IT1430C	CVDT1400	13.0 lbs 6.0 kg	51-100 ft. 15-30 m add 2.0 lbs (0.9 kg)
IF1800C	CVDF1800	15.25 lbs. 6.92 kg	0-50 ft. 0-15 m
		17.25 lbs 7.82 kg	51-100 ft. 15-30 m
IT1830C	CVDT1800	14.5 lbs. 6.6 kg	51-100 ft. 15-30 m add 2.0 lbs (0.9 kg)
IF2100C	CVDF2100	18.25 lbs. 8.28 kg	0-50 ft. 0-15 m
		22.25 lbs 10.09 kg	51-100 ft. 15-30 m
IT2130C	CVDT2100	19.0 lbs 8.6 kg	0-50 ft. 0-15 m
		21.0 lbs 10.6 kg	51-100 ft. 15-30 m

Charts

Cycle Times/24-Hour Ice Production/ Refrigerant Pressure Charts

These charts are used as guidelines to verify correct ice machine operation.

Accurate collection of data is essential to obtain the correct diagnosis.

- Production and cycle times are for dice cube - Half dice cube cycle times can be 2 - 3 minutes faster, depending on model and ambient temperature.
- Regular cube production derate is 7%.
- Ice production checks that are within 10% of the chart are considered normal. This is due to variances in water and air temperature. Actual temperatures will seldom match the chart exactly.
- Refer to “Troubleshooting” on page 81 for the data that must be verified for refrigeration diagnostics.
- Zero out manifold gauge set before obtaining pressure readings to avoid mis-diagnosis.
- Discharge and suction pressure are highest at the beginning of the cycle. Suction pressure will drop throughout the cycle. Verify the pressures are within the range indicated.
- Record beginning of freeze cycle suction pressure one minute after water pump energizes.
- 50 Hz dice and half dice production derate is 12%.
- 50 Hz regular cube total production derate is 14%.

IF0600C/CVDF0600

Remote Air-Cooled Condensing Unit Model

Characteristics vary depending on operating conditions.

All data on this page is preliminary and subject to change

Cycle Times

Freeze Time + Harvest Time = Total Cycle Time

Air Temp. Entering Condenser °F/°C	Freeze Time			Harvest Time
	Water Temperature °F/°C			
	50/10	70/21	90/32	
-20 to 70/ -29 to 21	8.9-10.2	9.5-11.0	10.3-11.9	.75-2.5
80/27	9.3-10.7	10.0-11.5	10.9-12.5	
90/32	9.6-11.1	10.4-12.0	11.4-13.0	
100/38	10.2-11.8	11.1-12.8	12.2-13.9	
110/43	11.0-12.6	12.0-13.8	13.2-15.1	

¹Times in minutes - Dice cube

24-Hour Ice Production

Air Temp. Entering Condenser °F/°C	Water Temperature °F/°C		
	50/10	70/21	90/32
-20 to 70/ -29 to 21	640	600	560
80/27	615	575	535
90/32	595	555	515
100/38	565	525	485
110/43	530	490	450

¹Based on average ice slab weight of 4.60 - 5.20 lb.

Operating Pressures

Air Temp. Entering Condenser °F/°C	Freeze Cycle		Harvest Cycle	
	Discharge Pressure psig	Suction Pressure psig	Discharge Pressure psig	Suction Pressure psig
-20 to 50/ -29 to 10	200-250	44-26	180-210	65-85
70/21	235-255	50-28	185-210	65-90
80/27	245-275	50-28	190-210	75-100
90/32	250-290	52-30	195-215	75-105
100/38	270-320	52-31	210-240	80-110
110/43	300-360	60-32	215-260	85-115

IBF0620C/CVDF0600

Remote Air-Cooled Condensing Unit Model

Characteristics vary depending on operating conditions.
All data on this page is preliminary and subject to change

Cycle Times

Freeze Time + Harvest Time = Total Cycle Time

Air Temp. Entering Condenser °F/°C	Freeze Time			Harvest Time
	Water Temperature °F/°C			
	50/10	70/21	90/32	
-20 to 70/ -29 to 21	8.9-10.2	9.5-11.0	10.3-11.9	.75-2.5
80/27	9.3-10.7	10.0-11.5	10.9-12.5	
90/32	9.6-11.1	10.4-12.0	11.4-13.0	
100/38	10.2-11.8	11.1-12.8	12.2-13.9	
110/43	11.0-12.6	12.0-13.8	13.2-15.1	

¹Times in minutes - Dice cube - ²Preliminary Data

24-Hour Ice Production

Air Temp. Entering Condenser °F/°C	Water Temperature °F/°C		
	50/10	70/21	90/32
-20 to 70/ -29 to 21	640	600	560
80/27	615	575	535
90/32	595	555	515
100/38	565	525	485
110/43	530	490	450

¹Based on average ice slab weight of 4.60 - 5.20 lb.

Operating Pressures

Air Temp. Entering Condenser °F/°C	Freeze Cycle		Harvest Cycle	
	Discharge Pressure psig	Suction Pressure psig	Discharge Pressure psig	Suction Pressure psig
-20 to 50/ -29 to 10	215-260	46-26	140-170	70-95
70/21	220-270	51-27	150-180	70-95
80/27	225-285	56-28	155-190	80-100
90/32	235-295	59-28	165-200	85-105
100/38	260-340	60-30	180-210	85-112
110/43	300-385	65-34	195-230	90-120

IBF0820C/CVDF0900

Remote Air-Cooled Condensing Unit Model

Characteristics vary depending on operating conditions.
All data on this page is preliminary and subject to change

Cycle Times

Freeze Time + Harvest Time = Total Cycle Time

Air Temp. Entering Condenser °F/°C	Freeze Time			Harvest Time
	Water Temperature °F/°C			
	50/10	70/21	90/32	
-20 to 70/ -29 to 21	8.5-9.8	9.3-10.7	10.0-11.5	.75-2.5
90/32	9.5-11.0	10.8-12.4	11.4-13.1	
100/38	11.2-12.9	12.3-14.1	13.3-15.2	
110/43	13.0-14.9	14.0-16.0	14.9-17.0	

¹Times in minutes - Dice cube

24-Hour Ice Production

Air Temp. Entering Condenser °F/°C	Water Temperature °F/°C		
	50/10	70/21	90/32
-20 to 70/ -29 to 21	825	770	720
90/32	750	675	640
100/38	650	600	560
110/43	570	535	505

¹Based on average ice slab weight of 5.75 - 6.50 lb.

Operating Pressures

Air Temp. Entering Condenser °F/°C	Freeze Cycle		Harvest Cycle	
	Discharge Pressure psig	Suction Pressure psig	Discharge Pressure psig	Suction Pressure psig
-20 to 50/ -29 to 10	230-260	45-25	180-205	60-80
70/21	250-275	55-30	180-205	75-105
80/27	260-290	60-31	185-215	80-110
90/32	265-300	60-32	190-220	80-110
100/38	300-370	70-34	200-250	90-115
110/43	310-385	75-35	230-260	95-115

IF0900C/CVDF0900

Remote Air-Cooled Condensing Unit Model

Characteristics vary depending on operating conditions.
All data on this page is preliminary and subject to change

Cycle Times

Freeze Time + Harvest Time = Total Cycle Time

Air Temp. Entering Condenser °F/°C	Freeze Time			Harvest Time
	Water Temperature °F/°C			
	50/10	70/21	90/32	
-20 to 70/ -29 to 21	8.9-10.3	9.4-14.4	10.1-11.6	.75-2.5
90/32	9.8-11.3	10.4-12.0	11.2-12.9	
100/38	11.0-12.7	11.9-13.6	12.8-14.6	
110/43	12.5-14.4	13.4-15.4	14.3-16.3	

¹Times in minutes - Dice cube

24-Hour Ice Production

Air Temp. Entering Condenser °F/°C	Water Temperature °F/°C		
	50/10	70/21	90/32
-20 to 70/ -29 to 21	795	760	715
90/32	730	695	650
100/38	660	620	580
110/43	590	555	525

¹Based on average ice slab weight of 5.75 - 6.50 lb.

Operating Pressures

Air Temp. Entering Condenser °F/°C	Freeze Cycle		Harvest Cycle	
	Discharge Pressure psig	Suction Pressure psig	Discharge Pressure psig	Suction Pressure psig
-20 to 50/ -29 to 10	230-260	45-25	180-205	60-80
70/21	250-275	50-30	180-205	75-105
80/27	260-290	55-31	185-215	80-110
90/32	265-300	60-32	190-220	80-110
100/38	300-370	70-34	200-250	90-115
110/43	310-385	75-35	230-260	95-115

IBT1020C/CVDT1200

Remote Air-Cooled Condensing Unit Model

Characteristics vary depending on operating conditions.

Cycle Times

Freeze Time + Harvest Time = Total Cycle Time

Air Temp. Entering Condenser °F/°C	Freeze Time			Harvest Time
	Water Temperature °F/°C			
	50/10	70/21	90/32	
-20 to 70/ -29 to 21	6.2-7.2	6.5-7.8	7.4-8.8	.75-2.5
80/27	6.4-7.7	6.8-8.1	7.8-9.2	
90/32	6.7-8.1	7.3-8.7	7.9-9.5	
100/38	7.1-8.5	7.8-9.2	8.9-10.6	
110/43	8.2-9.7	8.7-10.3	10.0-11.9	

¹Times in minutes - Dice cube

24-Hour Ice Production

Air Temp. Entering Condenser °F/°C	Water Temperature °F/°C		
	50/10	70/21	90/32
-20 to 70/ -29 to 21	1165	1115	1005
80/27	1125	1075	965
90/32	1085	1015	945
100/38	1035	965	855
110/43	925	875	775

¹Based on average ice slab weight of 6.2 - 7.2 lb.

Operating Pressures

Air Temp. Entering Condenser °F/°C	Freeze Cycle		Harvest Cycle	
	Discharge Pressure psig	Suction Pressure psig	Discharge Pressure psig	Suction Pressure psig
-20 to 50/ -29 to 10	240-340	70-44	165-260	120-135
70/21	300-340	70-44	165-280	110-130
80/27	310-350	70-44	170-290	110-140
90/32	315-360	75-45	180-300	115-145
100/38	395-440	80-50	215-360	150-175
110/43	395-460	80-50	220-370	155-180

IT1200C/CVDT1200

Remote Air-Cooled Condensing Unit Model

Characteristics vary depending on operating conditions.

Cycle Times

Freeze Time + Harvest Time = Total Cycle Time

Air Temp. Entering Condenser °F/°C	Freeze Time			Harvest Time
	Water Temperature °F/°C			
	50/10	70/21	90/32	
-20 to 70/ -29 to 21	6.4-7.7	7.4-8.8	7.8-9.4	.75-2.5
80/27	7.2-8.6	7.7-9.1	8.2-9.7	
90/32	7.6-9.0	8.0-9.5	8.8-10.4	
100/38	8.3-9.9	8.5-10.1	9.9-11.8	
110/43	8.9-10.6	9.7-11.5	10.5-12.4	

¹Times in minutes - Dice cube

24-Hour Ice Production

Air Temp. Entering Condenser °F/°C	Water Temperature °F/°C		
	50/10	70/21	90/32
-20 to 70/ -29 to 21	1075	1005	955
80/27	1025	975	925
90/32	985	940	870
100/38	910	890	780
110/43	860	800	745

¹Based on average ice slab weight of 6.2 - 7.2 lb.

Operating Pressures

Air Temp. Entering Condenser °F/°C	Freeze Cycle		Harvest Cycle	
	Discharge Pressure psig	Suction Pressure psig	Discharge Pressure psig	Suction Pressure psig
-20 to 50/ -29 to 10	230-340	70-40	155-200	110-135
70/21	275-350	70-40	160-210	110-130
80/27	290-360	70-41	170-210	115-140
90/32	310-370	75-41	180-210	120-140
100/38	365-470	90-44	220-315	130-175
110/43	375-480	90-45	225-320	150-175

IF1400C/CVDF1400

Remote Air-Cooled Condensing Unit Model

Characteristics vary depending on operating conditions.
All data on this page is preliminary and subject to change

Cycle Times

Freeze Time + Harvest Time = Total Cycle Time

Air Temp. Entering Condenser °F/°C	Freeze Time			Harvest Time
	Water Temperature °F/°C			
	50/10	70/21	90/32	
-20 to 70/ -29 to 21	11.3-13.4	12.3-14.6	14.2-16.8	.75-2.5
90/32	12.8-15.2	13.7-16.3	16.0-18.9	
100/38	13.8-16.3	15.8-18.7	17.1-20.2	
110/43	14.7-17.4	16.9-19.9	18.2-21.5	

¹Times in minutes - Dice cube

24-Hour Ice Production

Air Temp. Entering Condenser °F/°C	Water Temperature °F/°C		
	50/10	70/21	90/32
-20 to 70/ -29 to 21	1350	1255	1100
90/32	1210	1135	990
100/38	1130	1000	930
110/43	1065	940	875

¹Ice slab weight of one harvest cycle = 12.0 lb. to 14.0 lb.

6.0 to 7.0 lbs per evaporator

5.44 kg to 6.35 kg (2.72 to 3.18 kg per evaporator)

230/50/1 is approximately 12% lower than 230/60/1.

Operating Pressures

Air Temp. Entering Condenser °F/°C	Freeze Cycle		Harvest Cycle	
	Discharge Pressure psig	Suction Pressure psig	Discharge Pressure psig	Suction Pressure psig
-20 to 50/ -29 to 10	250-235	50-36	140-165	70-95
70/21	250-235	55-38	150-170	70-95
80/27	275-240	60-38	160-180	85-95
90/32	300-285	65-39	170-190	90-110
100/38	350-300	70-40	180-200	95-115
110/43	410-350	80-40	190-215	100-125

IT1430C/CVDT1400

Remote Air-Cooled Condensing Unit Model

Characteristics vary depending on operating conditions.

All data on this page is preliminary and subject to change

Cycle Times

Freeze Time + Harvest Time = Total Cycle Time

Air Temp. Entering Condenser °F/°C	Freeze Time			Harvest Time
	Water Temperature °F/°C			
	50/10	70/21	90/32	
-20 to 70/ -29 to 21	10.5-12.5	10.7-12.7	10.7-12.8	.75-2.0
90/32	11.8-14.1	12.3-14.6	13.8-16.3	
100/38	12.8-15.2	13.7-16.3	15.3-18.1	
110/43	14.0-16.6	15.4-18.3	17.0-20.2	

¹Times in minutes - Dice cube

24-Hour Ice Production

Air Temp. Entering Condenser °F/°C	Water Temperature °F/°C		
	50/10	70/21	90/32
-20 to 70/ -29 to 21	1436	1420	1411
90/32	1295	1252	1130
100/38	1205	1135	1030
110/43	1116	1020	931

¹Ice slab weight of one harvest cycle = 12.0 lb. to 14.0 lb.

6.0 to 7.0 lbs per evaporator

5.44 kg to 6.35 kg (2.72 to 3.18 kg per evaporator)

230/50/1 is approximately 12% lower than 230/60/1.

Operating Pressures

Air Temp. Entering Condenser °F/°C	Freeze Cycle		Harvest Cycle	
	Discharge Pressure psig	Suction Pressure psig	Discharge Pressure psig	Suction Pressure psig
-20 to 50/ -29 to 10	230-340	65-45	120-200	90-115
70/21	300-350	70-50	155-230	100-125
80/27	310-360	75-55	155-230	120-140
90/32	310-370	80-55	160-235	115-150
100/38	390-430	85-58	180-275	125-155
110/43	400-450	90-60	200-290	130-160

IF1800C/CVDF1800

Remote Air-Cooled Condensing Unit Model

Characteristics vary depending on operating conditions.
All data on this page is preliminary and subject to change

Cycle Times

Freeze Time + Harvest Time = Total Cycle Time

Air Temp. Entering Condenser °F/°C	Freeze Time			Harvest Time
	Water Temperature °F/°C			
	50/10	70/21	90/32	
-20 to 70/ -29 to 21	11.5-12.6	15.5-14.4	14.3-15.6	.75-2.5
90/32	14.3-15.5	16.4-17.8	17.7-19.3	
100/38	15.4-16.8	17.7-19.3	19.3-20.9	
110/43	11.5-12.6	15.5-14.4	14.3-15.6	

¹Times in minutes - Dice cube

24-Hour Ice Production

Air Temp. Entering Condenser °F/°C	Water Temperature °F/°C		
	50/10	70/21	90/32
-20 to 70/ -29 to 21	1715	1520	1410
90/32	1520	1375	1240
100/38	1415	1250	1160
110/43	1320	1160	1075

¹Ice slab weight of one harvest cycle = 15.5 lb. to 16.75 lb.

7.75 - 8.38 lb per evaporator

7.0 kg to 7.6 kg (3.5 to 3.8 kg per evaporator)

230/50/1 is approximately 12% lower than 230/60/1

Operating Pressures

Air Temp. Entering Condenser °F/°C	Freeze Cycle		Harvest Cycle	
	Discharge Pressure psig	Suction Pressure psig	Discharge Pressure psig	Suction Pressure psig
-20 to 50/ -29 to 10	215-250	50-30	140-155	65-90
70/21	215-260	50-33	140-155	65-90
80/27	240-280	50-34	145-165	65-95
90/32	250-295	55-35	150-170	65-95
100/38	290-365	65-36	160-190	75-100
110/43	300-380	70-37	170-200	80-110

IT1830C/CVDT1800

Remote Air-Cooled Condensing Unit Model

Characteristics vary depending on operating conditions.
All data on this page is preliminary and subject to change

Cycle Times

Freeze Time + Harvest Time = Total Cycle Time

Air Temp. Entering Condenser °F/°C	Freeze Time			Harvest Time
	Water Temperature °F/°C			
	50/10	70/21	90/32	
-20 to 70/ -29 to 21	10.4-11.4	11.4-12.4	12.5-13.6	.75-2.0
90/32	11.1-12.1	12.3-13.4	13.9-15.1	
100/38	12.5-13.7	14.0-15.2	15.7-17.1	
110/43	14.3-15.6	16.1-17.5	18.3-19.9	

¹Times in minutes - Dice cube

24-Hour Ice Production

Air Temp. Entering Condenser °F/°C	Water Temperature °F/°C		
	50/10	70/21	90/32
-20 to 70/ -29 to 21	1871	1734	1597
90/32	1775	1614	1450
100/38	1590	1442	1295
110/43	1410	1270	1129

¹Ice slab weight of one harvest cycle = 15.5 lb. to 16.75 lb.

7.75 - 8.38 lb per evaporator

7.0 kg to 7.6 kg (3.5 to 3.8 kg per evaporator)

230/50/1 is approximately 12% lower than 230/60/1

Operating Pressures

Air Temp. Entering Condenser °F/°C	Freeze Cycle		Harvest Cycle	
	Discharge Pressure psig	Suction Pressure psig	Discharge Pressure psig	Suction Pressure psig
-20 to 50/ -29 to 10	230-320	70-40	120-180	95-115
70/21	290-340	75-45	150-200	100-125
80/27	300-350	75-46	160-210	110-130
90/32	310-360	80-48	180-280	120-140
100/38	380-450	85-50	200-320	120-160
110/43	415-470	90-55	210-375	120-170

IF2100C/CVDF2100

Remote Air-Cooled Condensing Unit Model

Characteristics vary depending on operating conditions.

Cycle Times

Freeze Time + Harvest Time = Total Cycle Time

Air Temp. Entering Condenser °F/°C	Freeze Time			Harvest Time
	Water Temperature °F/°C			
	50/10	70/21	90/32	
-20 to 70/ -29 to 21	10.4-11.4	11.4-12.4	12.3-13.4	.75-2.5
80/27	11.3-12.3	12.1-13.2	13.2-14.4	
90/32	11.6-12.6	12.4-13.5	14.2-15.4	
100/38	12.8-13.9	13.9-15.1	15.3-16.6	
110/43	13.9-15.1	14.9-16.2	16.0-17.4	

¹Times in minutes - Dice cube

24-Hour Ice Production

Air Temp. Entering Condenser °F/°C	Water Temperature °F/°C		
	50/10	70/21	90/32
-20 to 70/ -29 to 21	1920	1785	1670
80/27	1800	1690	1565
90/32	1760	1655	1470
100/38	1610	1500	1375
110/43	1500	1405	1315

¹Ice slab weight of one harvest cycle = 16.0 lb. to 17.25 lb.

7.75 - 8.38 lb per evaporator

7.0 kg to 7.6 kg (3.5 to 3.8 kg per evaporator)

230/50/1 is approximately 12% lower than 230/60/1

Operating Pressures

Air Temp. Entering Condenser °F/°C	Freeze Cycle		Harvest Cycle	
	Discharge Pressure psig	Suction Pressure psig	Discharge Pressure psig	Suction Pressure psig
-20 to 50/ -29 to 10	220-250	45-28	125-140	70-80
70/21	220-260	50-28	125-160	70-80
80/27	220-275	50-28	130-180	70-90
90/32	260-315	58-30	150-190	70-100
100/38	300-360	65-30	160-200	80-110
110/43	320-400	70-30	170-210	90-120

IT2130C/CVDT2100

Remote Air-Cooled Condensing Unit Model

Characteristics vary depending on operating conditions.

Cycle Times

Freeze Time + Harvest Time = Total Cycle Time

Air Temp. Entering Condenser °F/°C	Freeze Time			Harvest Time
	Water Temperature °F/°C			
	50/10	70/21	90/32	
-20 to 70/ -29 to 21	10.3-11.2	11.2-12.1	12.1-13.1	0.75-2.0
80/27	10.8-12.0	11.8-12.7	12.4-15.0	
90/32	12.1-13.1	11.9-13.1	12.5-16.0	
100/38	13.1-14.0	13.5-14.8	15.6-16.8	

¹Times in minutes - Dice cube

24-Hour Ice Production

Air Temp. Entering Condenser °F/°C	Water Temperature °F/°C		
	50/10	70/21	90/32
-20 to 70/ -29 to 21	2000	1850	1710
80/27	1830	1750	1550
90/32	1750	1690	1425
100/38	1665	1530	1390

¹Ice slab weight of one harvest cycle = 16.0 lb. to 17.25 lb.
7.75 - 8.38 lb per evaporator
7.0 kg to 7.6 kg (3.5 to 3.8 kg per evaporator)
230/50/1 is approximately 12% lower than 230/60/1

Operating Pressures

Air Temp. Entering Condenser °F/°C	Freeze Cycle		Harvest Cycle	
	Discharge Pressure psig	Suction Pressure psig	Discharge Pressure psig	Suction Pressure psig
-20 to 50/ -29 to 10	275-310	75-38	115-195	85-110
70/21	285-320	80-40	135-225	95-115
80/27	295-335	85-43	150-240	105-135
90/32	335-375	90-45	165-260	120-150
100/38	345-400	95-50	180-280	130-165
110/43	350-510	105-55	215-300	130-185

THIS PAGE INTENTIONALLY LEFT BLANK

Diagrams

Wiring Diagrams

The following pages contain electrical wiring diagrams. Be sure you are referring to the correct diagram for the ice machine you are servicing.

Warning

Always disconnect power before working on electrical circuitry.

Some components are wired differently on energy efficient machines. Please verify your model number ("Model Numbers" on page 19) to reference the correct diagrams.

WIRING DIAGRAM LEGEND

The following symbols are used on all of the wiring diagrams:



Equipment Ground



Wire Number Designation

(The number is marked at each end of the wire)



Multi-Pin Connection



(Electrical Box Side) —>

(Compressor Compartment Side) >—

Male/Female Disconnect



Crimp Connector

IF0600C/IBF0620C/IBF0820C/IF0900C 1PH

QuietCube® Ice Machine Head Section

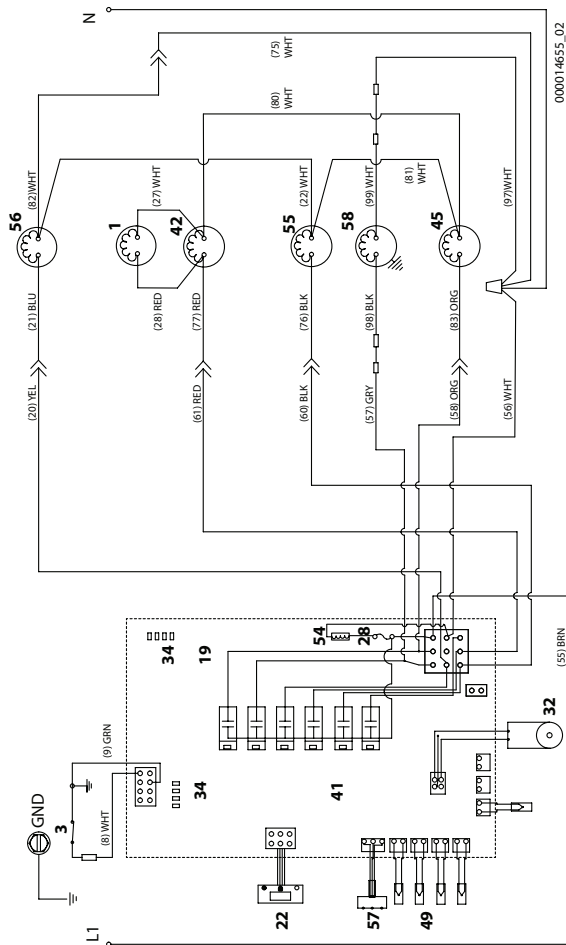

000014655_02

IF0600C/IBF0620C/IBF0820C/IF0900C/IT0900C 1Ph

Number	Component
1	Air Pump Harvest Assist
3	Bin Switch
19	Control Board
22	Touchscreen
32	Ice Thickness Probe
34	LED
41	See Control Board Schematic For Detail
42	Solenoid Valve - Harvest
45	Solenoid Valve - Liquid Line
49	Thermistors
54	Transformer Control Board
55	Water Dump Valve
56	Water Inlet Valve
57	Water Level Probe
58	Water Pump
Wire Colors	
BLK	Black
BLU	Blue
BRN	Brown
GRY	Grey
ORG	Orange
PRPL	Purple
RED	Red
WHT	White
YEL	Yellow
Refer to control board schematic for control board detail	

IT1200C/IBT1020C 1PH

Number	Component
1	Air Pump Harvest Assist
3	Bin Switch
19	Control Board
22	Touchscreen
32	Ice Thickness Probe
34	LED
41	See Control Board Schematic For Detail
42	Solenoid Valve - Harvest
43	Solenoid Valve - Harvest
45	Solenoid Valve - Liquid Line
49	Thermistors
54	Transformer Control Board
55	Water Dump Valve
56	Water Inlet Valve
57	Water Level Probe
58	Water Pump
Wire Colors	
BLK	Black
BLU	Blue
BRN	Brown
ORG	Orange
RED	Red
WHT	White
YEL	Yellow
Refer to control board schematic for control board detail	

IF1400C/IF1800C/IF2100C 1PH

QuietCube® Ice Machine Head Section

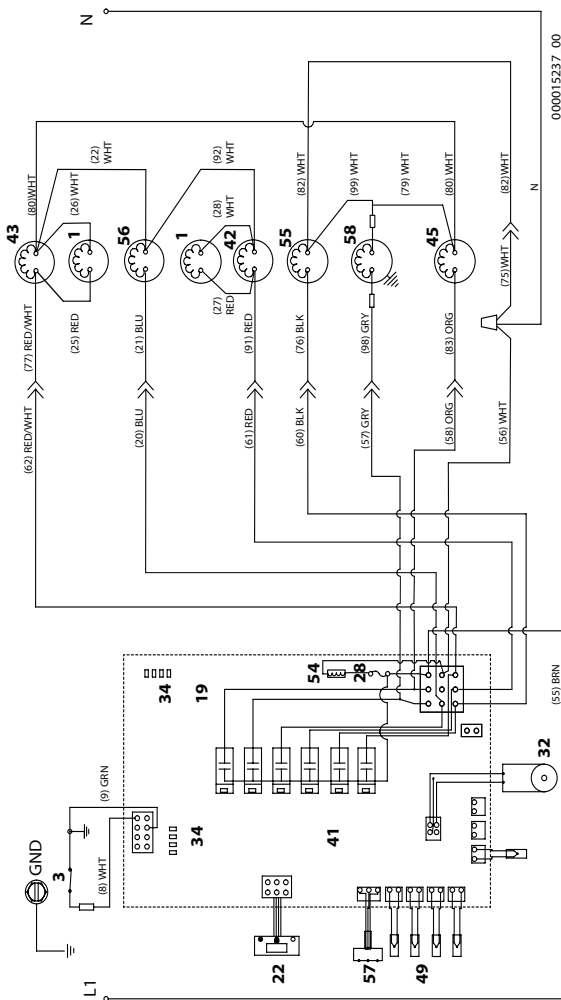

IF1400/IF1800C/IF2100C 1ph

Number	Component
1	Air Pump Harvest Assist
3	Bin Switch
19	Control Board
22	Touchscreen
32	Ice Thickness Probe
34	LED
41	See Control Board Schematic For Detail
42	Solenoid Valve - Harvest Left Hand
43	Solenoid Valve - Harvest Right Hand
45	Solenoid Valve - Liquid Line
49	Thermistors
54	Transformer Control Board
55	Water Dump Valve
56	Water Inlet Valve
57	Water Level Probe
58	Water Pump
Wire Colors	
BLK	Black
BLU	Blue
BRN	Brown
GRY	Grey
ORG	Orange
RED	Red
WHT	White
Refer to control board schematic for control board detail	

IT1430C/IT1830C/IT2130C 1PH

QuietCube® Ice Machine Head Section

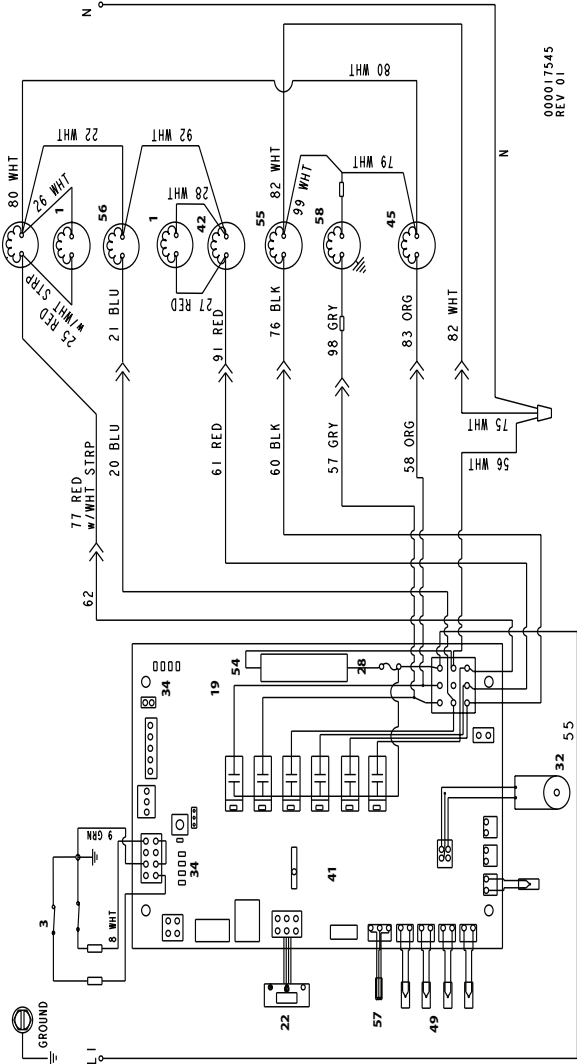

000017545
REV 01

IT1430C/IT1830C/IT2130C 1PH

Number	Component
1	Air Pump Harvest Assist
3	Bin Switch
19	Control Board
22	Touchscreen
32	Ice Thickness Probe
34	LED
41	See Control Board Schematic For Detail
42	Solenoid Valve - Harvest Left Hand
43	Solenoid Valve - Harvest Right Hand
45	Solenoid Valve - Liquid Line
49	Thermistors
54	Transformer Control Board
55	Water Dump Valve
56	Water Inlet Valve
57	Water Level Probe
58	Water Pump
Wire Colors	
BLK	Black
BLU	Blue
BRN	Brown
GRY	Grey
ORG	Orange
RED	Red
WHT	White
Refer to control board schematic for control board detail	

CVD 1PH CONDENSING UNIT WITH DELAY RELAY

QuietQube® CVD Condensing Unit

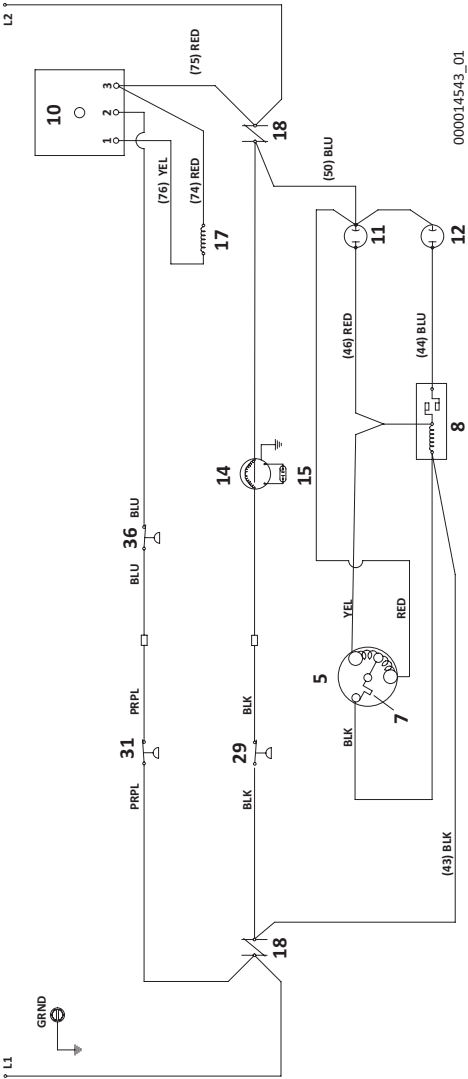

000014543_01

CVD 1PH CONDENSING UNIT WITH DELAY RELAY

Number	Component
5	Compressor
7	Compressor Overload
8	Compressor Potential Relay
10	Compressor Time Delay Relay
11	Compressor Run Capacitor
12	Compressor Start Capacitor
14	Condenser Fan Motor
15	Condenser Fan Motor Run Capacitor
17	Contactors Coil
18	Contactors Contacts - Note - Wires are combined/connected on single contact contactors.
31	High Pressure Cutout
36	Low Pressure Cutout
Wire Colors	
BLK	Black
BLU	Blue
PRPL	Purple
RED	Red
YEL	Yellow

CVD 1PH CONDENSING UNIT WITHOUT DELAY RELAY

QuietQube® CVD Condensing Unit

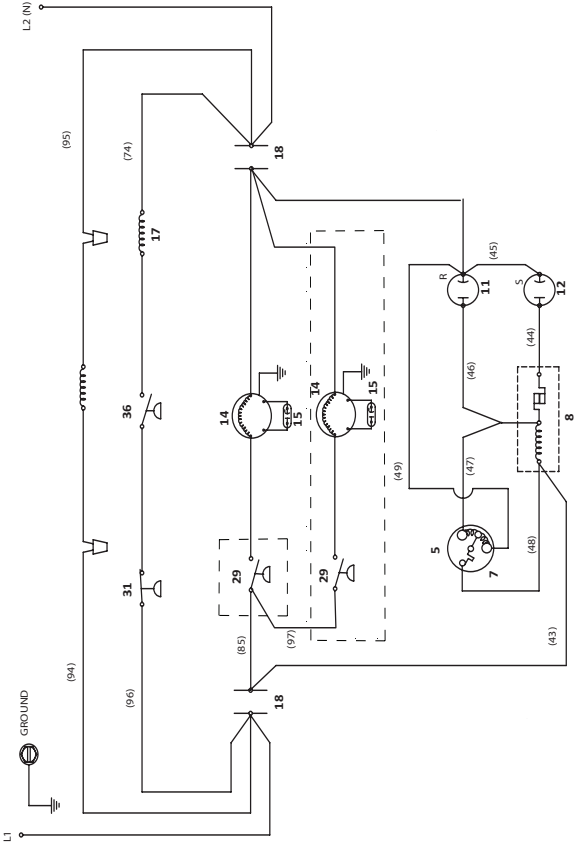

CVD 1PH CONDENSING UNIT WITHOUT DELAY RELAY

Number	Component
5	Compressor
7	Compressor Overload
8	Compressor Potential Relay
11	Compressor Run Capacitor
12	Compressor Start Capacitor
14	Condenser Fan Motor
15	Condenser Fan Motor Run Capacitor
17	Contactator Coil
18	Contactator Contacts - Note - Wires are combined/connected on single contact contactors.
31	High Pressure Cutout
36	Low Pressure Cutout
Wire Colors	
BLK	Black
BLU	Blue
PRPL	Purple
RED	Red
YEL	Yellow

CVD 3PH CONDENSING UNIT WITH DELAY RELAY

QuietQube® CVD Condensing Unit

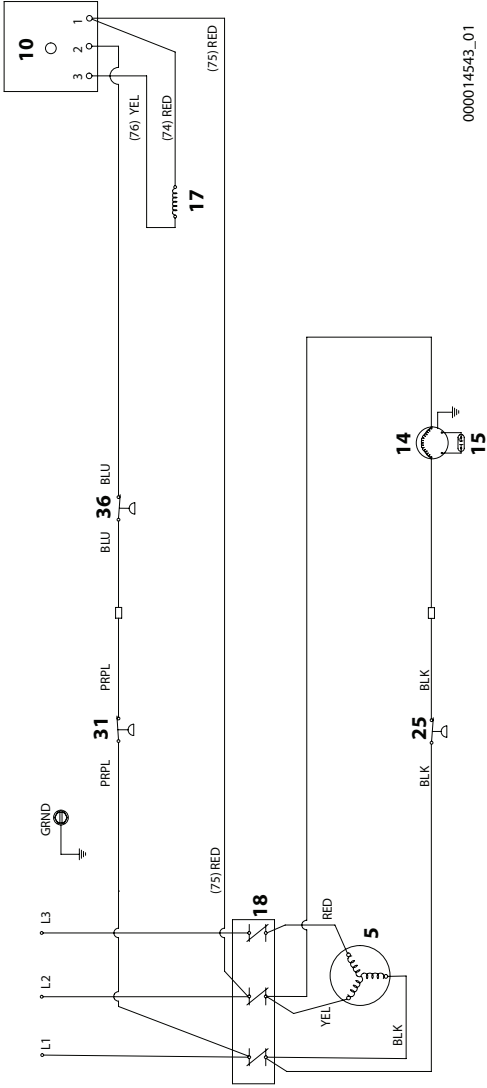

000014543_01

CVD 3PH CONDENSING UNIT WITH DELAY RELAY

Number	Component
5	Compressor
10	Compressor Time Delay Relay
14	Condenser Fan Motor
15	Condenser Fan Motor Run Capacitor
17	Contactator Coil
18	Contactator Contacts
31	High Pressure Cutout
36	Low Pressure Cutout
Wire Colors	
BLK	Black
BLU	Blue
PRPL	Purple
RED	Red
YEL	Yellow

CVD 3PH CONDENSING UNIT WITHOUT DELAY RELAY

QuietQube® CVD Condensing Unit

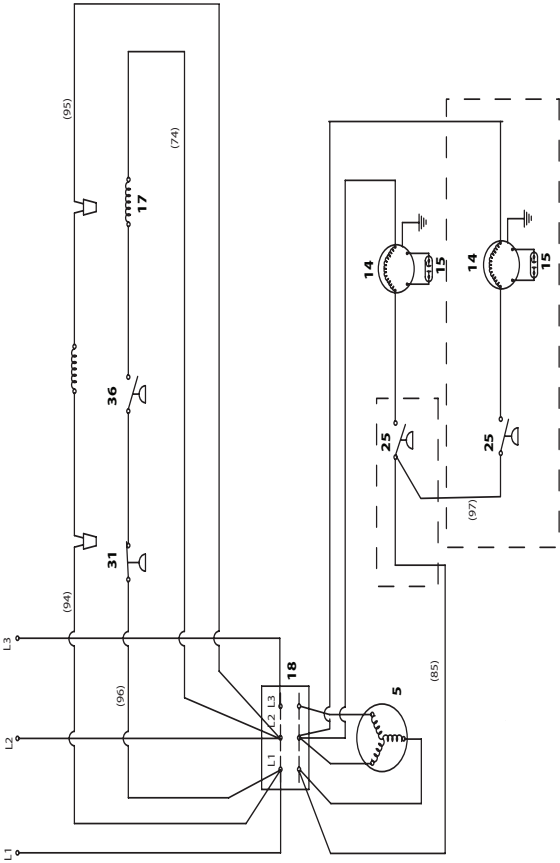

CVD 3PH CONDENSING UNIT WITHOUT DELAY RELAY

Number	Component
5	Compressor
14	Condenser Fan Motor
15	Condenser Fan Motor Run Capacitor
17	Contactora Coil
18	Contactora Contacts
31	High Pressure Cutout
36	Low Pressure Cutout
Wire Colors	
BLK	Black
BLU	Blue
PRPL	Purple
RED	Red
YEL	Yellow

Electronic Control Board

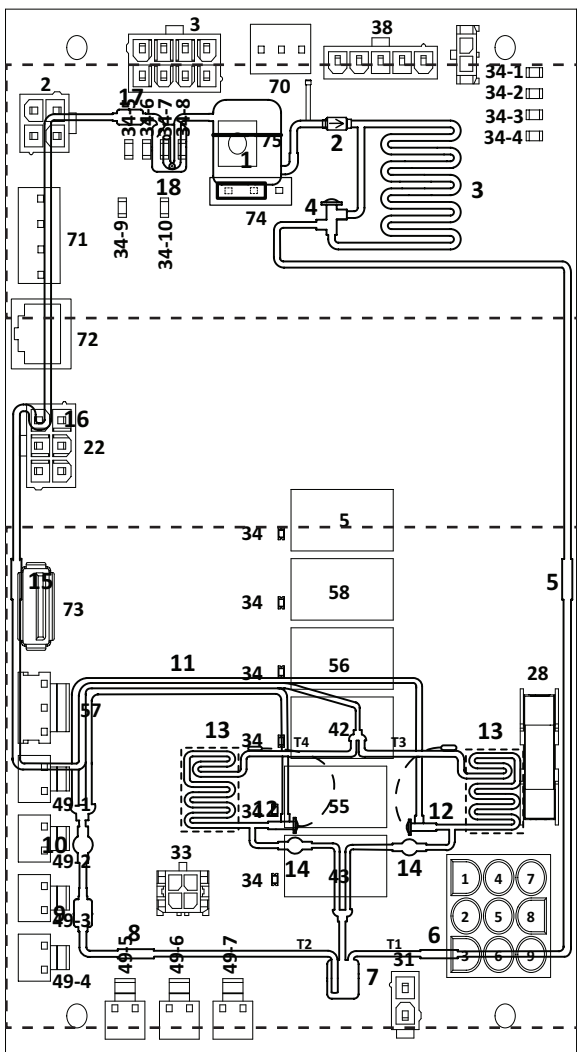

Electronic Control Board Schematic

Number	Description
2	iAuCS
3	Bin Switch
5	Compressor Contactor Coil Relay
22	Touchscreen
28	Fuse
31	High Pressure Cutout
33	Ice Thickness Probe
34	LED - Relays
34-1	LED - Display
34-2	LED - Micro
34-3	LED - Clean
34-4	LED - Harvest
34-5	LED - Ice Thickness Probe
34-6	LED - High Water Probe
34-7	LED - Low Water Probe
34-8	LED - Display Bypass Is Active
34-9	LED - Right Bin Switch
34-10	LED - Left Bin Switch
38	LuminIce®
42	Relay Solenoid Valve - Harvest Left Hand
43	Relay Solenoid Valve - Harvest Right Hand
49-1	Thermistor T1 Liquid Line Temperature
49-2	Thermistor T2 - Discharge Line Temperature
49-3	Thermistor T3 - Evaporator Inlet Temperature Single Evaporator models Evaporator Outlet Temperature Dual Evaporator Models
49-4	Thermistor T4 - Evaporator Outlet Temperature
49-5	Thermistor T5 - Bin Level Probe
49-6	Thermistor T6 - Potable water Temperature
49-7	Thermistor T7 - Ambient Air Temperature
55	Relay Water Dump Valve
56	Relay Water Inlet Valve
57	Water Level Probe
58	Relay Water Pump
70	RS232 Communication Port
71	RS485 Communication Port
72	12VDC Power Supply
73	USB Connector
74	Reverse Osmosis/Deionized Water Usage Jumper
75	Display Bypass Button

IF0600C/CVDF0600 IB0620C/CVDF0600

IBF0820/CVDF0900 IF0900C/CVDF0900

Number	Component
1	Compressor
2	Discharge Check Valve
3	Condenser - Remote Air-Cooled
4	Head Pressure Control Valve
5	Liquid Line Shut-off Valve
6	Liquid Line Check Valve
7	Receiver
8	Receiver Access Valve
9	Liquid Line Filter Drier
10	Liquid Line Solenoid Valve
11	Heat Exchanger
12	TXV - Thermostatic Expansion Valve
13	Evaporator
14	Harvest Solenoid Valve
15	Suction Shut-off Valve
16	S Trap - Required on 21' or greater rise
17	Suction line Filter
18	Accumulator
T1	Thermistor - Receiver Inlet
T2	Thermistor - Receiver Outlet
T3	Thermistor - Evaporator Inlet
T4	Thermistor - Evaporator Outlet

IBT1020C/CVDT1200 IT1200C/CVDT1200

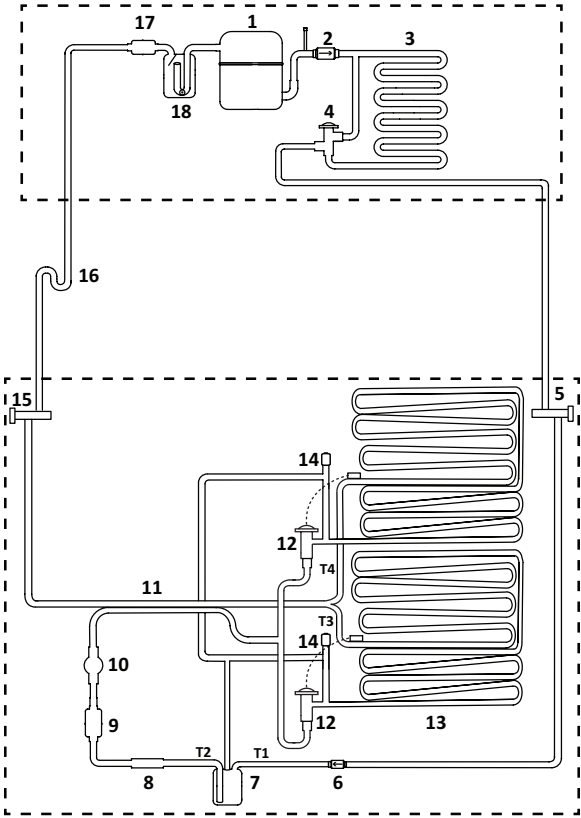

IBT1020C/CVDT1200 IT1200C/CVDT1200

Number	Component
1	Compressor
2	Discharge Check Valve
3	Condenser - Remote Air-Cooled
4	Head Pressure Control Valve
5	Liquid Line Shut-off Valve
6	Liquid Line Check Valve
7	Receiver
8	Receiver Access Valve
9	Liquid Line Filter Drier
10	Liquid Line Solenoid Valve
11	Heat Exchanger
12	TXV - Thermostatic Expansion Valve
13	Evaporator
14	Harvest Solenoid Valve
15	Suction Shut-off Valve
16	S Trap - Required on 21' or greater rise
17	Suction line Filter
18	Accumulator
T1	Thermistor - Receiver Inlet
T2	Thermistor - Receiver Outlet
T3	Thermistor - Evaporator Outlet
T4	Thermistor - Evaporator Outlet

Dual Evaporators

IF1400C/IF1800C

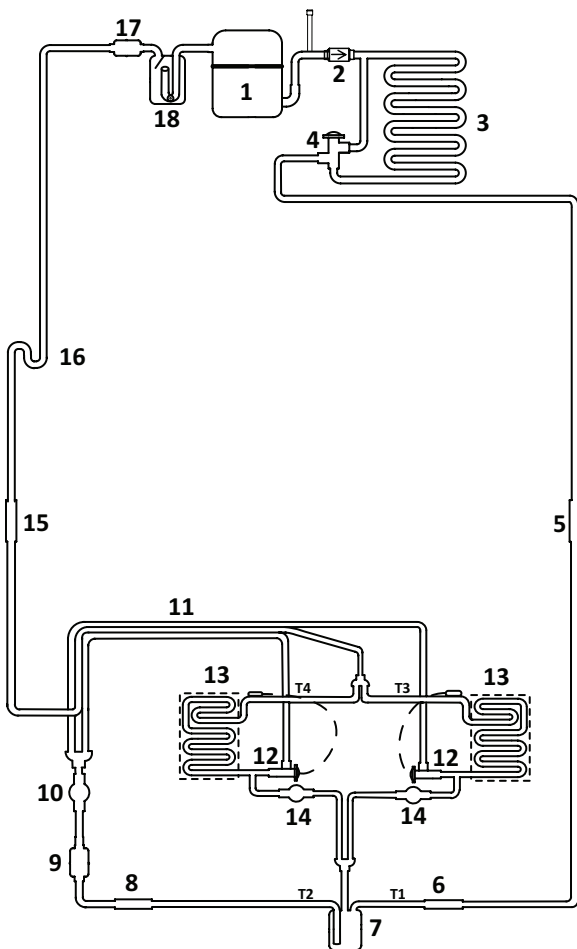

IF1400C/IF1800

Number	Component
1	Compressor
2	Discharge Check Valve
3	Condenser - Remote Air-Cooled
4	Head Pressure Control Valve
5	Liquid Line Shut-off Valve
6	Liquid Line Check Valve
7	Receiver
8	Receiver Access Valve
9	Liquid Line Filter Drier
10	Liquid Line Solenoid Valve
11	Heat Exchanger
12	TXV - Thermostatic Expansion Valve
13	Evaporator
14	Harvest Solenoid Valve
15	Suction Shut-off Valve
16	S Trap - Required on 21' or greater rise
17	Suction line Filter
18	Accumulator
T1	Thermistor - Receiver Inlet
T2	Thermistor - Receiver Outlet
T3	Thermistor - Evaporator Outlet
T4	Thermistor - Evaporator Outlet

IF2100C

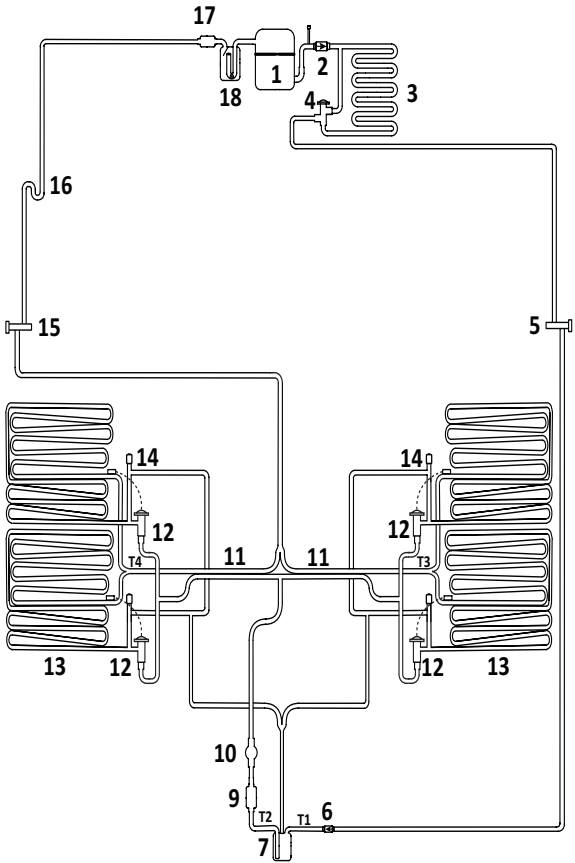

IF2100C

Number	Component
1	Compressor
2	Discharge Check Valve
3	Condenser - Remote Air-Cooled
4	Head Pressure Control Valve
5	Liquid Line Shut-off Valve
6	Liquid Line Check Valve
7	Receiver
9	Liquid Line Filter Drier
10	Liquid Line Solenoid Valve
11	Heat Exchanger
12	TXV - Thermostatic Expansion Valve
13	Evaporator
14	Harvest Solenoid Valve
15	Suction Shut-off Valve
16	S Trap - Required on 21' or greater rise
17	Suction line Filter
18	Accumulator
T1	Thermistor - Receiver Inlet
T2	Thermistor - Receiver Outlet
T3	Thermistor - Evaporator Outlet
T4	Thermistor - Evaporator Outlet

THIS PAGE INTENTIONALLY LEFT BLANK



MANITOWOC ICE
2110 SOUTH 26TH STREET
MANITOWOC, WI 54220

800-545-5720
WWW.MANITOWOCICE.COM

©2022 Manitowoc Ice except where explicitly stated otherwise. All rights reserved.

Part Number: 000015431 Rev 06 04/24