



UNDERBAR PREP SINKS
Top Shelf Series Prep Sinks

NSF
C US
ASME A112.19.3/
CSA B45.4
NSF/ANSI 2



TSF8PS-BRT



TSF12PS-SR



TSF20PS-SBRT



TSF24PS-SBRT

JOB	
AREA	
ITEM NO.	
MODEL NO.	

MODELS	
TSF8PS-BRT	TSF12PS-SB
TSF12PS-SR	TSF14PS-SRT
TSF18PS-SBR	TSF20PS-SBRT
TSF24PS-SBRT	

KEY PRODUCT FEATURES AND BENEFITS

- A durable, 18-gauge sink bowl has a long life span and is dent resistant, even under heavy use
- A 1" thick, high-density cutting board is highly durable, warp resistant, and easy to remove for cleaning
- Our **NEW Perlick Quick Clamp** leg attachment has increased strength and features an easy, toolless installation
- Durable, all stainless construction is rust-resistant and long-lasting

Quick Features:

- Prep sinks offer a seamless front apron for added aesthetics and ease of cleaning
- Our versatile worktop allows the bartender to remove the cutting board and utilize the lower drainboard component for additional tool or glass storage space
- Glass racks are securely mounted, yet easily removable for ease of cleaning
- Our underbar equipment utilizes our Perlick Quick Clamp leg attachment for superior rigidity
- The rinser features a high performance spray pattern for quick, thorough rinsing
- With seven new models to choose from, you can be sure to find a model that fits your design and bartender needs

Form No. Z2382
Rev 09.26.22

MODEL NUMBERS - TSF8PS-BRT, TSF12PS-SB, TSF12PS-SR, TSF14PS-SRT, TSF18PS-SBR, TSF20PS-SBRT, TSF24PS-SBRT



UNDERBAR PREP SINKS
Top Shelf Series Prep Sinks

MODEL NUMBERS - TSF8PS-BRT, TSF12PS-SB, TSF12PS-SR, TSF14PS-SRT, TSF18PS-SBR, TSF20PS-SBRT, TSF24PS-SBRT

MODEL NOS.		TSF8PS-BRT	TSF12PS-SB	TSF12PS-SR	TSF14PS-SRT	TSF18PS-SBR	TSF20PS-SBRT	TSF24PS-SBRT	
DIMENSIONS: EXTERIOR (mm)	Depth	24" (609.6)	24" (609.6)	24" (609.6)	24" (609.6)	24" (609.6)	24" (609.6)	24" (609.6)	
	Width	8" (203.2)	12" (304.8)	12" (304.8)	14" (355.6)	18" (457.2)	20" (508)	24" (609.6)	
	Weight lbs (kg)	32 (14.5)	39 (17.7)	39 (17.7)	42 (19.1)	50 (22.7)	54 (24.5)	58 (26.3)	
MATERIALS	Cutting board	1" thick white PVC, includes drip groove, removes for easy cleaning							
	Rinser	4-3/8" Diameter heavy gauge stainless steel rack, NSF-listed stainless steel rinser							
	Tool Well with Faucet	5.5" OD Stainless steel tool well with removable basket. Chrome plated fine-stream faucet.							
	Sink Bowl	Stainless steel, all horizontal and vertical edges 1-1/2" radius with balled corners. Furnished with 1-1/2" drain socket.							
	Legs	1-5/8" Tubular, stainless steel with 1" adjustable thermoplastic foot							
PLUMBING	Rinser *	Drain pan: 1/2" ID brass drain tube with 1/2" NPSM thread and machined end to accept 1/2" ID tubing. Rinser: 1/2" NPSM thread with John Guest Connector for 3/8" ID flexible water line.							
	Tool Well with Faucet	1" NPS male, 1/2" IPS shank (includes 1/4" MPT tailpiece)							
	Sink	1-1/2" NPS male							
	Faucet	Hot and cold connection. 3/8" Compression 9/16-24 thread. Faucet includes 18" braided stainless leads.							
OPTIONAL ACCESSORIES	Faucets	NA	Wall mount gooseneck or wall mount swing spout						
	Wet Waste Pan	NA	7055-52	7055-52	7055-52	7055-48	7055-52	7055-52	
	Aerator	NA	0.5 GPM or 1.5 GPM, faucets come with 2.0 GPM aerator						
	End Splash	Left and right available							
	Wrist Blades	NA	Wrist blades can be ordered separately						
	Leg Relocation Kit	Perlick Flex Mount leg kit allows the rear legs to move forward giving you 7" of clearance behind the rear legs to the back of the equipment (see leg relocation installation guide)							

* Rinser Note: Check local plumbing codes. Install in-line water regulator set to 15-20 psi (not Included).
Install in-line shut off valve (not included) and turn off nightly.

TSF8PS-BRT

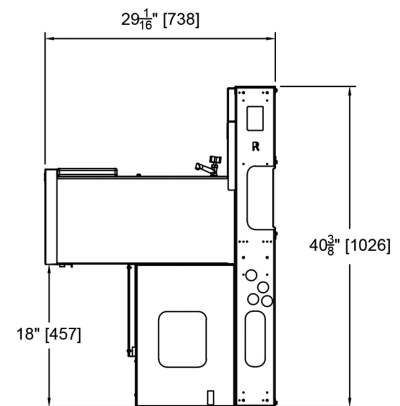
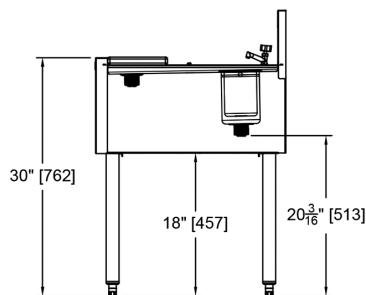
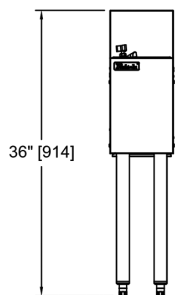
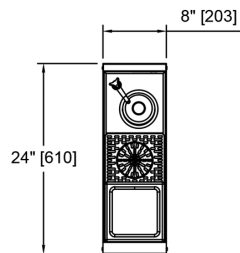

Faucet shown for clarity. Must be ordered separately.

Form No. Z2382
Rev 09.26.22



UNDERBAR PREP SINKS
Top Shelf Series Prep Sinks

MODEL NUMBERS - TSF8PS-BRT, TSF12PS-SB, TSF12PS-SR, TSF14PS-SRT, TSF18PS-SBR, TSF20PS-SBRT, TSF24PS-SBRT

TSF12PS-SR

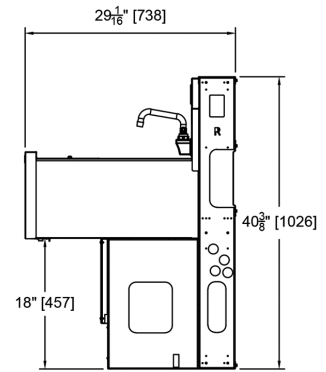
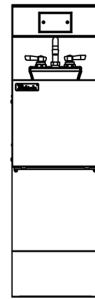
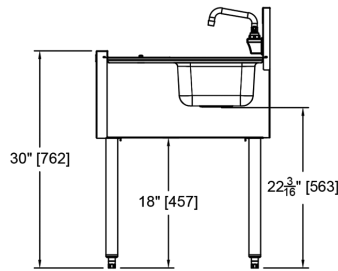
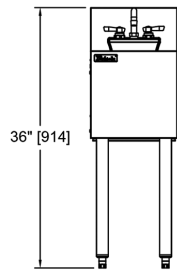
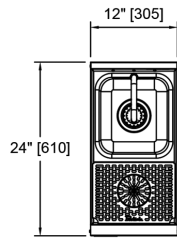

TSF12PS-SB

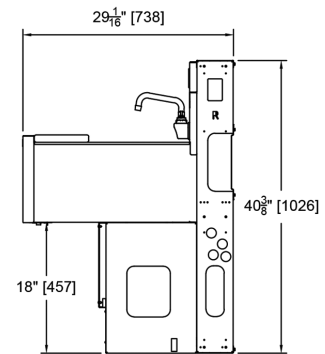
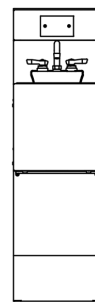
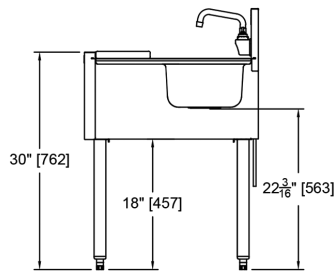
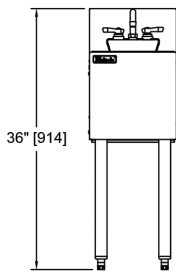
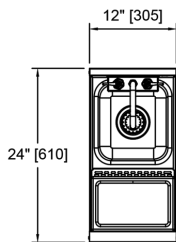

Faucet shown for clarity. Must be ordered separately.

Form No. Z2382
 Rev 09.26.22



UNDERBAR PREP SINKS
Top Shelf Series Prep Sinks

MODEL NUMBERS - TSF8PS-BRT, TSF12PS-SB, TSF12PS-SR, TSF14PS-SRT, TSF18PS-SBR, TSF20PS-SBRT, TSF24PS-SBRT

TSF14PS-SRT

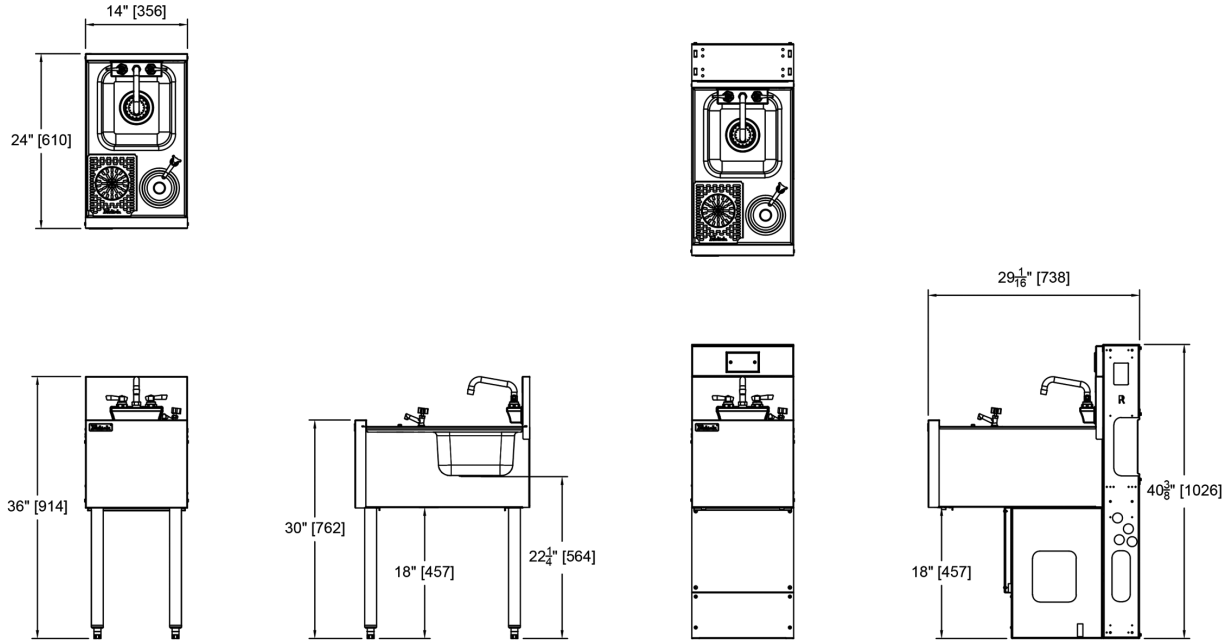

TSF18PS-SBR

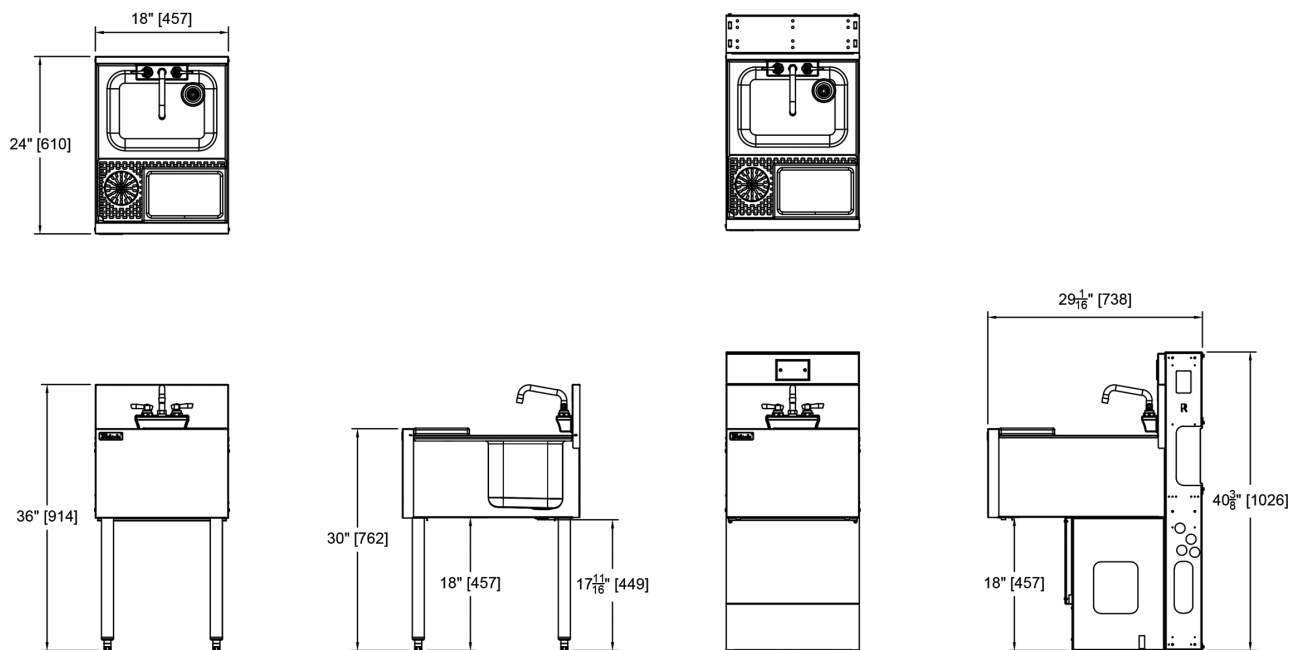

Faucet shown for clarity. Must be ordered separately.

Form No. Z2382
 Rev 09.26.22



UNDERBAR PREP SINKS
Top Shelf Series Prep Sinks

MODEL NUMBERS - TSF8PS-BRT, TSF12PS-SB, TSF12PS-SR, TSF14PS-SRT, TSF18PS-SBR, TSF20PS-SBRT, TSF24PS-SBRT

TSF20PS-SBRT

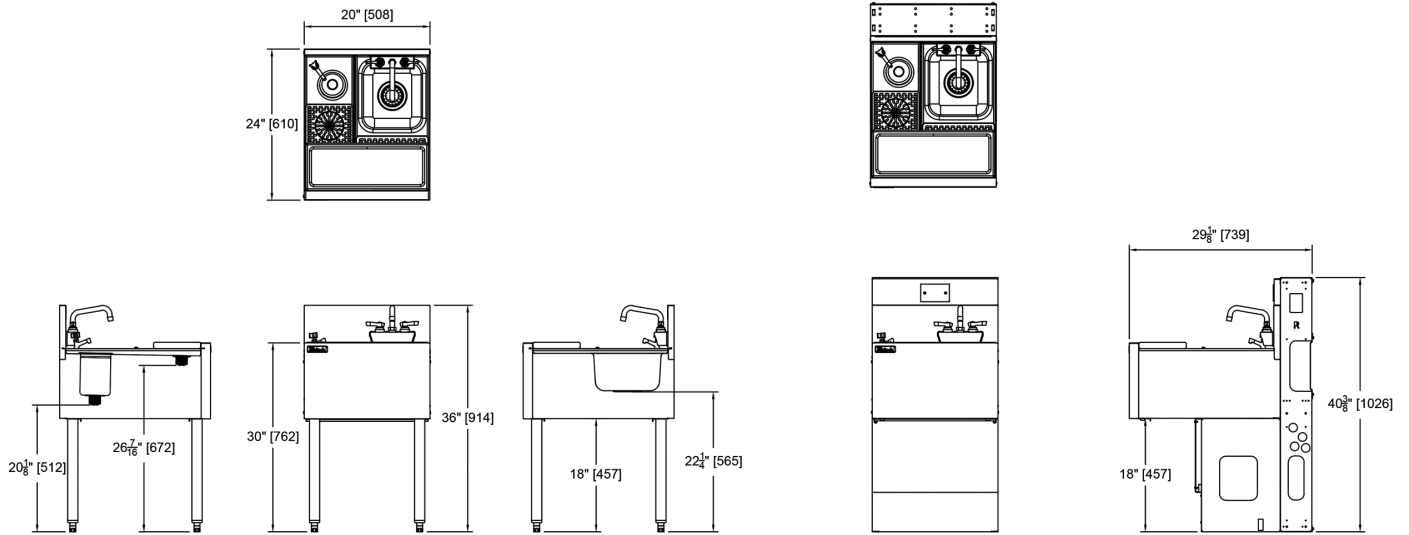

TSF24PS-SBRT

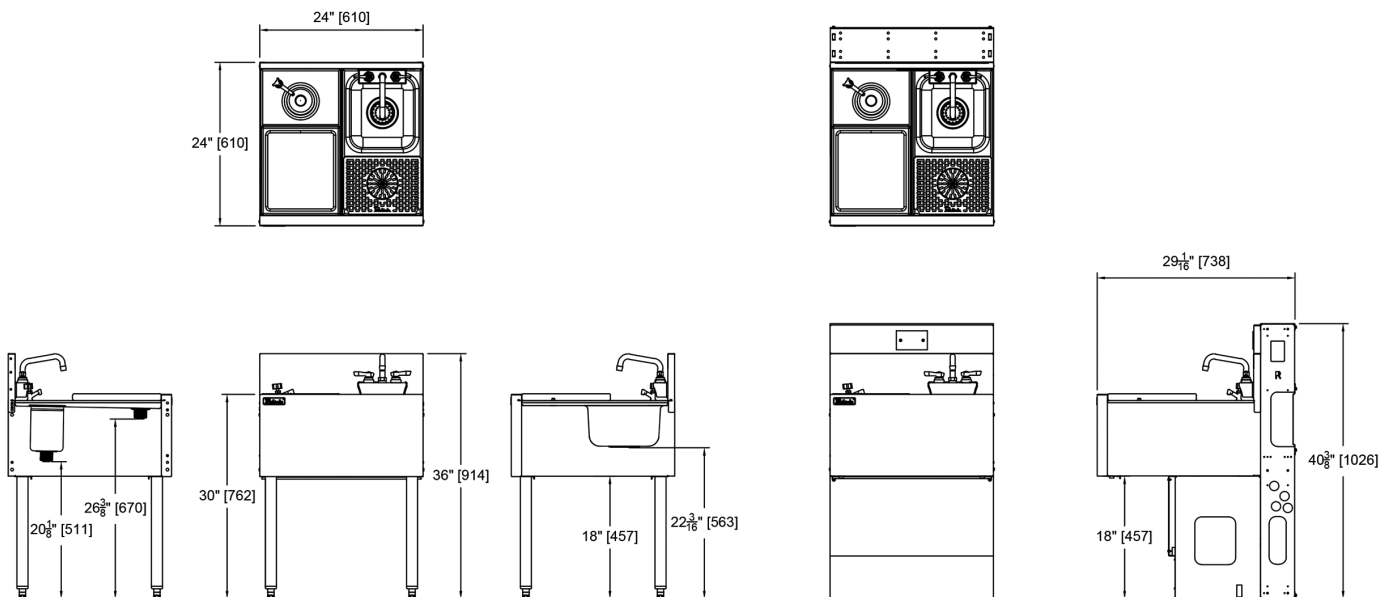

Faucet shown for clarity. Must be ordered separately.

Form No. Z2382
 Rev 09.26.22